

CATFE701



CAR RACING
Brake Pads

2017



 **FEDERAL-MOGUL**
MOTORPARTS



www.ferodoracing.com

COMPOUND SELECTION GUIDE

MATERIAL CHARACTERISTICS

Relative Performance Characteristics of Ferodo Racing Range Under Heavy-Duty Conditions

	Pad Life	Disc Life	Average mu	Fade	Pedal Travel	Release
DS2500	Good	Moderate	Good	Good	Moderate	Moderate
DS3000	Good	Moderate	Excellent	Moderate	Good	Moderate
FER4003	Good	Moderate	Moderate	Good	Moderate	Excellent
DS1.11	Excellent	Excellent	Moderate	Excellent	Excellent	Excellent
DSUNO	Moderate	Excellent	Excellent	Excellent	Excellent	Excellent

Excellent	
Good	
Moderate	

SUGGESTED APPLICATIONS

		TYPE OF APPLICATION					
MATERIAL		ROAD	TRACK DAY	RALLY	CIRCUIT SPRINT	CIRCUIT HEAVY DUTY/ENDURANCE	FORMULA
ROAD	DS PERFORMANCE	F/R					
RACING	DS2500		F/R	R	R		F/R
	DS3000			F/R	F		F/R
	FER4003			R	R		F/R
	DS1.11				F/R	F/R	F/R
	DSUNO			F	F	F/R	F/R

NOTE: **F = FRONT**
R = REAR



RACING



RACING



TECHNICAL INFORMATION II

PADS

PRODUCT RANGE	16
APPLICATIONS	1000
PADS FOR RACING CALIPERS	2000
PAD DRAWINGS	3000
BRAKE PADS XREF (COMPETITORS TO FERODO)	4000

ISO/TS 16949 & ISO 14001 Certified Production

All **Ferodo** Racing brake pads are manufactured to the highest international ISO quality standards at Federal Mogul's dedicated manufacturing facility in Italy.

Every brake pad has a total of 26 separate quality controls during its manufacture which guarantees a repeatable and consistent product within and between every batch.

Precision Engineering

All of the pad back-plates are manufactured from high tensile steel meaning minimum distortion when subjected to the high clamping forces common in motorsport use.

Pads are manufactured to maintain high tolerances on the pad and back-plate dimensions including : flatness , parallelism and overall thickness.

This results in a rapid and uniform transmission of pressure from the brake system to the pads.

Thermal Under-layer

Unlike many competitive products most **Ferodo** Racing brake pad incorporate a thermal under-layer between the backing-plate and the friction material.

This reduces the brake caliper's operating temperature by up to 80 deg C and significantly reduces the risk of boiling the brake fluid which causes a "spongy" feeling in the pedal.

Disc Friendly

Unlike many competitive products **Ferodo** pads are kind on brake discs.

Ferodo pads are developed to optimize both the pad and disc life. Our philosophy is not to increase pad life with the casualty of excessive disc wear.

High Controllability

All **Ferodo** Racing brake pads are engineered to perform with a relatively constant coefficient of friction (μ) across a wide range of temperatures , pressures and vehicle speeds.

This results in a consistent brake feel for the driver meaning that the braking torque is a linear response to pedal pressure.

Wide Range of Material choices and Fitments

Ferodo Racing has one of the widest range of pad shapes in the racing/performance brake pad market.

This fitment range is available with the necessary compound choice meaning that there is nearly always a solution to your needs.

EN INTRODUCTION

This catalogue details the Ferodo range of racing brake pads. Designed for ease of use by both Distributors and Racing Teams, the catalogue contains application/compound data and product shape illustrations.

PART NUMBER SUFFIXES

All part numbers in the range section of this catalogue feature a suffix. This suffix identifies the material compound available for each part number

H	DS2500
C	4003
R	DS3000
W/WB	DS1.11
Z/ZB	DSUNO

Many part numbers are available in more than one material and are therefore listed accordingly with different suffixes. For example:
(FRP3001H = DS2500, FRP3001C = 4003,
FRP3001R = DS3000, FRP3001W=DS1.11, FRP3001Z=DSUNO)

COMPOUND SELECTION

As a general guide we recommend that you consider the following when making your material compound selection:

4WD cars = same compound front and rear

Rear traction cars = same compound front and rear.

Front traction cars = high friction level in the front axle (i.e. DS3000), lower friction level on the rear axle (i.e. DS2500, 4003).

For further advice please contact Ferodo Racing.

F INTRODUCTION

Le catalogue Ferodo Racing est un outil convivial qui permet aux réseaux de distribution et aux écuries de course de choisir la bonne plaquette et la qualité la meilleure pour gagner les courses.

SUFFIXES

Chez Ferodo, nous utilisons des suffixes pour identifier les matériaux :

H	DS2500
C	4003
R	DS3000
W/WB	DS1.11
Z/ZB	DSUNO

Pour cette raison, vous pouvez trouver la même référence (par ex: FRP3001) qui identifie la forme de la plaquette avec suffixes différents qui déterminent les qualités
(FRP3001H = DS2500, FRP3001C = 4003,
FRP3001R = DS3000, FRP3001W=DS1.11, FRP3001Z=DSUNO)

CHOIX DES MATERIAUX

Quelques conseils pour le choix des matériaux en fonction de la motricité des véhicules:

Pour les 4 roues motrices = même qualité à l'avant et l'arrière.

Pour les propulsions = même qualité à l'avant et l'arrière.

Pour les tractions = haut niveau de friction à l'avant (exemple DS3000) et plus faible niveau de friction à l'arrière (exemple DS2500, 4003).

I INTRODUZIONE

Il catalogo Ferodo Racing è uno strumento di lavoro che permette alla rete di distribuzione Ferodo ed ai Teams di scegliere correttamente la figura della pastiglia e la mescola per ottenere la miglior efficienza dell'impianto frenante.

SIGNIFICATO DEI SUFFISSI

Il suffisso viene utilizzato per identificare la mescola:

H	DS2500
C	4003
R	DS3000
W/WB	DS1.11
Z/ZB	DSUNO

Pertanto, lo stesso numero di codice (es. FRP3001) potrà essere accompagnato da differenti suffissi che indicheranno la mescola richiesta
(FRP3001H =DS2500, FRP3001C = 4003,
FRP3001R = DS3000,FRP3001W=DS1.11,
FRP3001Z=DSUNO).

SCELTA DELLA MESCOLA

Una regola che potete utilizzare con le mescole Ferodo Racing:

Vetture a 4 ruote motrici = stessa mescola per anteriore e posteriore.

Vetture a trazione posteriore = stessa mescola per anteriore e posteriore.

Vetture a trazione anteriore = mescola ad alto coefficiente d'attrito sull'anteriore (es. DS3000) ed a minor coefficiente d'attrito per il posteriore (es. DS2500 o 4003).

Per ulteriori informazioni contattare la Ferodo ai numeri riportati su questo catalogo.

E INTRODUCCION

El catálogo Ferodo Racing es una herramienta de fácil utilización, que permite a los distribuidores y a los equipos de competición, seleccionar la aplicación correcta de la pastilla de freno y el compuesto adecuado, para la obtención del rendimiento más elevado y así poder alcanzar los mejores resultados deportivos.

SUFIJOS

Los diferentes compuestos de los materiales Ferodo Racing, se identifican con los siguientes sufijos:

H	DS2500
C	4003
R	DS3000
W/WB	DS1.11
Z/ZB	DSUNO

Por esta razón, se puede encontrar el mismo número de referencia de pastilla (por ejemplo: FRP3001) que identifica la forma de está, con distintos sufijos para determinar los diferentes compuestos Ferodo Racing
(FRP3001H = DS2500, FRP3001C = 4003,
FRP3001R = DS3000, FRP3001W=DS1.11, FRP3001Z=DSUNO)

ESCOGER EL COMPUESTO

Criterios de selección para la utilización de los diferentes compuestos:

Vehículos con cuatro ruedas motrices (4WD) = mismo compuesto delante y detrás.

Vehículos con tracción trasera = mismo compuesto delante y detrás.

Vehículos con tracción delantera = alto coeficiente de fricción en el eje delantero (por ejemplo, DS3000), bajo coeficiente de fricción en el eje trasero (por ejemplo, 4003).

D

EINFÜHRUNG

Der Ferodo Racing Katalog ist ein anwenderfreundliches Werkzeug, daß den Händlern und den Rennteams erlaubt, den richtigen Belag in der richtigen Qualität zu wählen, um Rennen zu gewinnen.

SUFFIX

Ferodo benutzt eine Kurzbezeichnung (Suffix) die Qualität für:

H	DS2500
C	4003
R	DS3000
W/WB	DS1.11
Z/ZB	DSUNO

Aus diesem Grund finden Sie die Teile-Nr. (z.B. FRP3001) die die Belagabmessung bestimmt mit verschiedenen Kurzbezeichnungen für die jeweilige Ferodo Racing Qualität.

(FRP3001H = DS2500, FRP3001C = 4003,
FRP3001R = DS3000, FRP3001W=DS1.11, FRP3001Z=DSUNO)

QUALITÄTEN AUSWAHL

Kurzempfehlung für die richtige Auswahl der Qualität:

Allradfahrzeuge = gleiche Qualität vorn + hinten.

Hinterradangetriebene Fahrzeuge = gleiche Qualität vorn + hinten.

Vorderradangetriebene Fahrzeuge = Hoher

Reibwert für die Vorderachse (z.B. DS3000).

Niedrigerer Reibwert für die Hinterachse (z.B. DS2500,4003).

中文

簡介

本目錄記載了 Ferodo 賽車及高性能煞車片資料。方便業界及參賽人仕使用。本目錄亦提供了以下資料:-

1. 車輛型號對應表
2. 煞車片物料選擇
3. 煞車片圖樣及呎吋。

煞車片物料的代號(尾碼)

所有煞車片型號都包含一個尾碼, 這代表不同的物料!

H	DS2500
C	4003
R	DS3000
W/WB	DS1.11
Z/ZB	DSUNO

很多型號煞車片都會生產多於一種物料

所以需要依靠尾碼來區分。

(FRP3001H = DS2500, FRP3001C = 4003,
FRP3001R = DS3000, FRP3001W=DS1.11, FRP3001Z=DSUNO)

煞車片物料的選擇

一般情況下, 我們會提供以下建議:-

4WD (四驅車)=頭皮及尾皮(選用相同物料)

尾驅車=頭皮及尾皮(選用相同物料)

頭驅車=頭皮要比尾皮性能較高(例如頭用DS3000,尾用DS2500)

如需要更多資料, 請向 Ferodo Racing 查詢。

日本語

ご紹介

レーシングチーム様、代理店様とともに使用しやすいようこのカタログはフェロードのレーシングブレーキパッドの詳細（使用目的、材質データ、形状図）をご案内しております。

パーツ番号

品番の最後にアルファベットがつけてあります。下記の通り材質ごとに異なります。

H	DS2500
C	4003
R	DS3000
W/WB	DS1.11
Z/ZB	DSUNO

ひとつの品番でも複数の材質がご用意してあるものがあります。

(FRP3001H =DS2500, FRP3001C = 4003,
FRP3001R = DS3000,FRP3001W=DS1.11,
FRP3001Z=DSUNO).

コンパウンドの選択

一般的なコンパウンド選択のガイダンスをご案内いたします。

4WD 車輛 = 前後同じ材質

FR 車輛 = 前後同じ材質

FF 車輛 = フロントにμの高い材質 (例 DS3000), リアに低いμの材質 (例 DS2500,4003).

ご質問がありましたらフェロードレーシングまたは代理店にお問い合わせ下さい。

EN

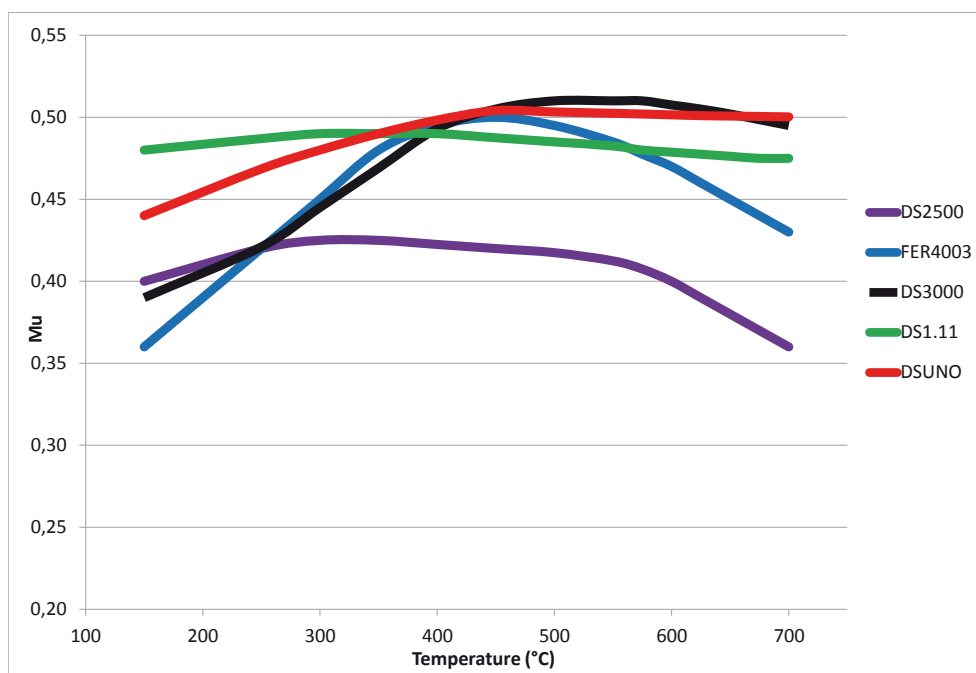

DS1.11 (W/WB)

- Heavy duty endurance material
- Applications - touring car, GT, single seat
- Average friction coefficient 0.46 over working temperature range of 200°-700°C
- Long life
- Very kind to discs

DSUNO (Z/ZB)

- Heavy duty semi-endurance material
- Applications – touring car, GT, single seat, rally
- Average friction coefficient 0.48 over working temperature range of 200°-700°C
- Very controllable torque output
- Very kind to discs
- Long life

DS2500 (H)

- Track day & light race use for all vehicle types
- Road style refinement but with race material ability to withstand heat with respect to life and μ
- Average friction coefficient of 0.42 over working temperature range of 20°-500°C

DS3000 (R)

- Heavy duty all-round material choice
- Multiple applications – touring car, rally, single seat
- Average friction coefficient 0.48 over working temperature range of 200°-650°C

FER4003 (C)

- Light/medium duty race material specifically for Formula cars
- Applications – Formula cars, occasional rally
- Average friction coefficient 0.46 over working temperature range of 200°-450°C
- Very short bedding time
- Excellent bite
- Low drag & Excellent release
- Offers control to avoid wheel lock when downforce reduces

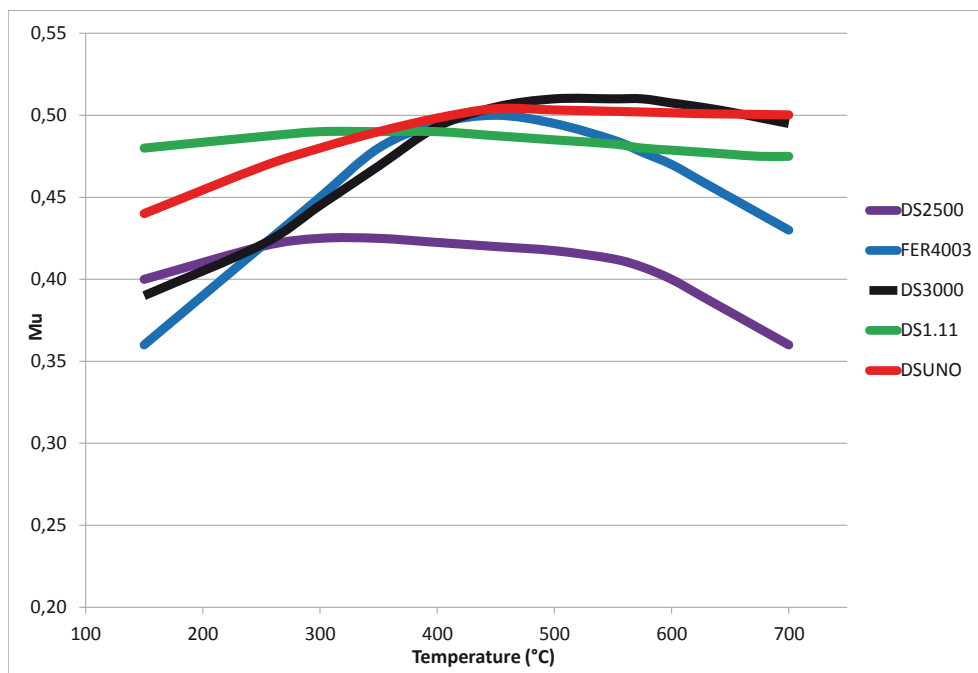

DS1.11 (W/WB)

- Materiale per gare di durata, utilizzi estremi
- Utilizzi - turismo, GT, monoposto
- Coefficiente d'attrito medio 0.46 tra 200°-700°C
- Lunga durata
- Bassa usura dei dischi

DSUNO (Z/ZB)

- Materiale per uso semi-endurance (3 / 6 ore)
- Utilizzi - turismo, GT, monoposto, rally
- Coefficiente d'attrito medio 0.48 tra 200°-700°C
- Livello d'attrito facilmente modulabile
- Bassa usura dei dischi
- Lunga durata

DS2500 (H)

- Utilizzabile per uso privato in pista e per gare soft da tutti i tipi di veicoli
- Confort stradale ma proprietà del materiale di resistere al calore garantendo buona durata e livello d'attrito superiore al ricambio originale
- Coefficiente di attrito medio di 0.42 tra 20°-500°C

DS3000 (R)

- Materiale ad alte prestazioni con ottima adattabilità
- Utilizzi multipli - turismo, rally, monoposto
- Coefficiente d'attrito medio 0.48 tra 200°-650°C

FER4003 (C)

- Materiale corsa per applicazioni medio-leggere specifico per vetture Formula (da 500 a 1100 Kg)
- Utilizzi - Vetture Formula e rally
- Coefficiente d'attrito medio 0.46 tra 200°-450°C
- Tempo di rodaggio molto breve
- Ottimo attacco iniziale
- Bassa coppia residua e ottimo rilascio pedale
- Facilmente modulabile (anti bloccaggio ruota in casi di riduzione di downforce)

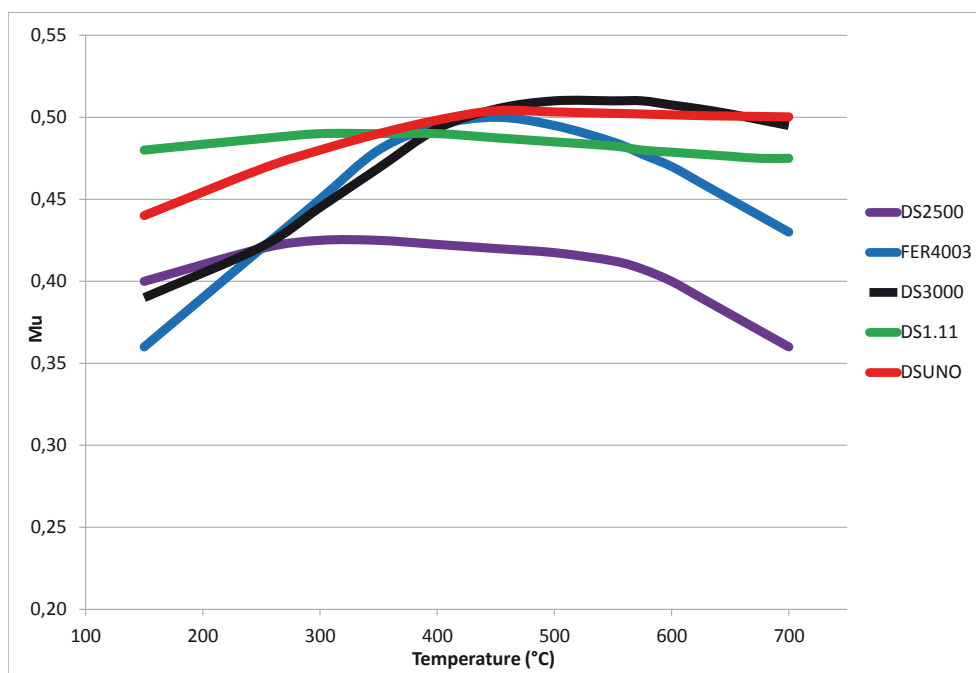
F**DS1.11 (W/WB)**

- Matériau endurant pour applications sévère
- Applications multiples – berlines, GT, monoplaces
- Coefficient de friction moyen de 0.46, plage de température comprise entre 200°C et 700°C
- Longue durée de vie
- Peu agressif avec les disques

DS2500 (H)

- Circuit club et usage sportif pour tous types de véhicules
- Pour une conduite typée route, mais avec les capacités d'un matériau de course résistant aux hautes températures et qui limite l'usure due à la friction.
- Coefficient de friction moyen de 0.42, sur une plage de température comprise entre 20°C et 500°C

FER4003 (C)

- Matériau de course pour applications légères/moyennes, développé spécifiquement pour les voitures type Formule monoplace
- applications monoplace, éventuellement rallye
- Coefficient de friction moyen de 0.46, plage de température comprise entre 200°C et 450°C
- Temps de rodage très court
- Excellent mordant
- Peu de couple résiduel au lâcher de pédale, mais attaque franche
- Permet un excellent dosage afin d'éviter les blocages de roue en perte d'adhérence.

DSUNO (Z/ZB)

- Matériau de semi endurance pour applications sévères
- Applications multiples – berlines, GT, monoplaces, rallye, circuit
- Coefficient de friction moyen de 0.48, plage de température comprise entre 200°C et 700°C
- Couple très contrôlable, dosage facile
- Très peu agressif avec les disques
- Longue durée de vie

DS3000 (R)

- Matériau pour tous types d'applications sévères
- Applications multiples - berlines et monoplaces, circuit et rallye
- Coefficient de friction moyen de 0.48, plage de température comprise entre 200°C et 650°C

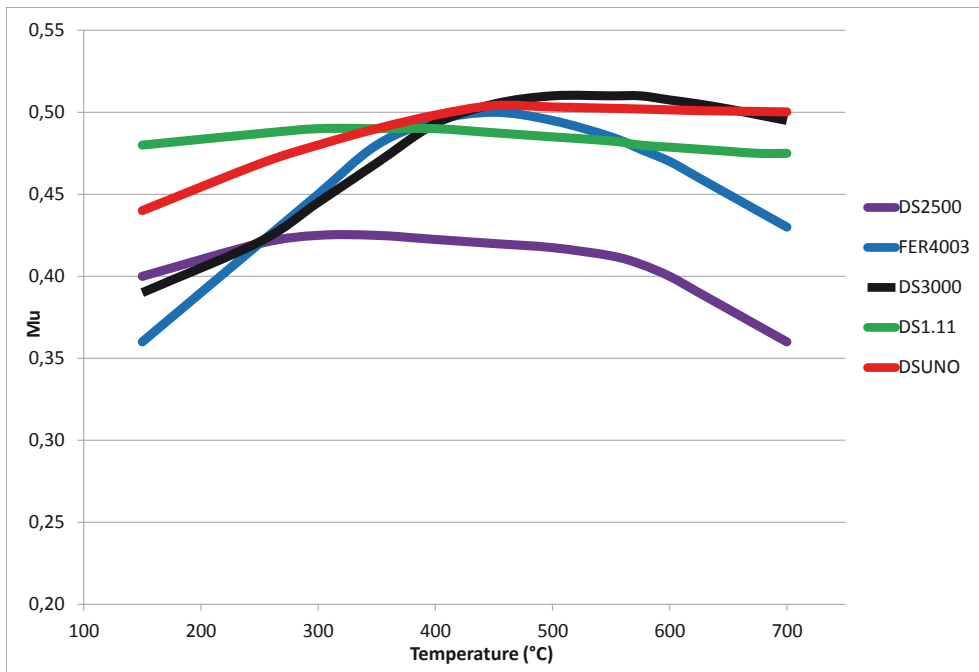
E

DS1.11 (W/WB)

- Material para carreras largas
- Aplicaciones: turismo, GT, Formula
- Coeficiente de fricción medio 0,46 entre 200 y 700°C
- Larga vida
- No es agresivo con los discos

DSUNO (Z/ZB)

- Material para carreras sprint de duración media(3 horas)
- Aplicaciones: turismo, GT, Formula, Rally
- Coeficiente de fricción medio 0,48 entre 200 y 700°C
- Facilmente modulable
- Desgasta muy poco los discos
- Buena vida de el producto

DS2500 (H)

- Material para circuito y carreras suaves para todos los vehiculos
- Uso deportivo en carreteras con mayor aguante de el calor, mayor vida y mejor nivel de fricción
- Coeficiente de fricción medio de 0,42 estable entre 20 y 500°C

DS3000 (R)

- Material para competiciones de cualquier tipo
- Múltiples aplicaciones : turismo, rallies y formulas
- Coeficiente de fricción medio de 0,48 entre 200 y 650°C

FER4003 (C)

- Especifico para coches Formula y lijeros
- Aplicaciones: Formula y rallies
- Coeficiente de fricción medio 0,46 entre 200 y 450°C
- Tiempo de rodaje muy bajo
- Ataque inicial muy alto
- Fricción residual en las ruedas muy baja
- Es muy sencillo prevenir el bloqueo de las ruedas cuando el downforce se reduce

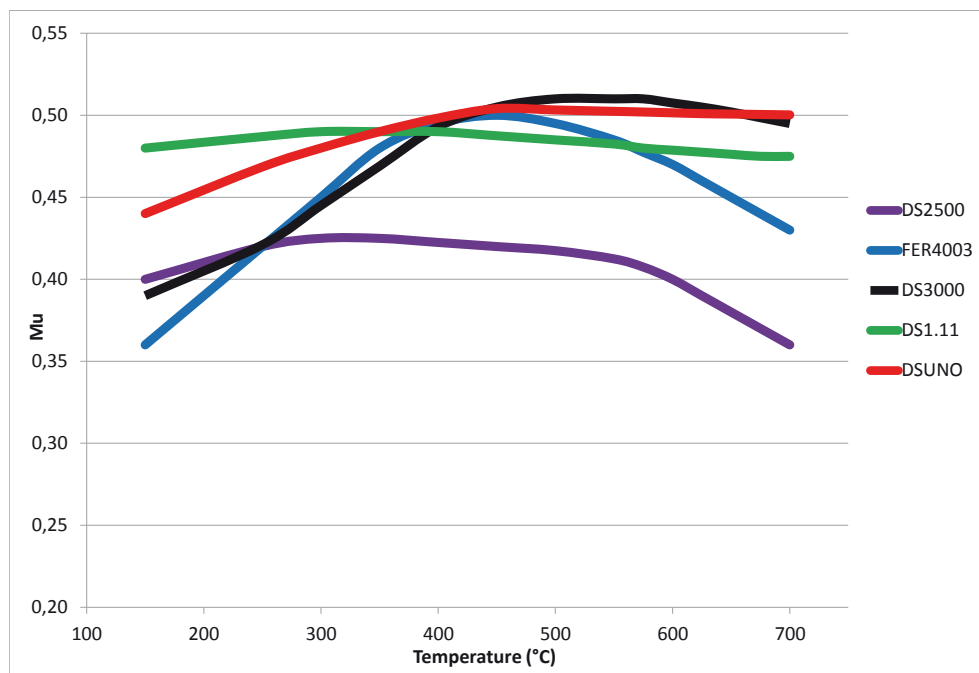
D

DS1.11 (W/WB)

- Langstreckentauglich, für harte Einsatzbedingungen
- Einsatzmöglichkeiten: Tourenwagen, GT und Einsitzer
- Durchschnittlicher Reibungskoeffizient bei 0,46
- Temperaturbereich 200 – 700 Grad C
- Hohe Lebensdauer
- Geringer Verschleiß der Scheiben

DS2500 (H)

- Für "Track Days" und "leichte" Rennen gedacht, geeignet für alle Arten von Fahrzeugen
- Verbesserte Straßeneigenschaften, Verwendung von Rennmaterialien mit besserem Hitzewiderstand um Lebensdauer und Reibwert zu verbessern
- Durchschnittlicher Reibungskoeffizient bei 0,42, Temperaturbereich von 20 – 500 Grad C

FER4003 (C)

- Für leichte bis mittlere Einsatzbedingungen; speziell auf Formel-Fahrzeuge abgestimmt
- Einsatzmöglichkeiten: Formel-Fahrzeuge, aber auch für Rally-Einsätze
- Durchschnittlicher Reibungskoeffizient bei 0,46.
- Extrem kurze Einfahrzeit.
- Temperaturbereich 200 – 450 Grad C.
- Hervorragender Biss.
- schnelles Lösen von der Scheibe.
- Gute Kontrollierbarkeit, verhindert das Blockieren des Rades, gerade dann wenn der Anpressdruck reduziert ist.

DSUNO (Z/ZB)

- Für erschwerte Rennbedingungen, teilweise Langstrecken tauglich.
- Anwendungen: Tourenwagen, GT-Klassen, Einsitzer, Rally.
- Durchschnittlicher Reibungskoeffizient bei 0,48.
- Temperaturbereich 200 – 700 Grad C.
- Bremskraft gut zu dosieren.
- Relativ geringe Scheibenabnutzung.
- Hohe Lebensdauer.

DS3000 (R)

- Der Allrounder für erschwerte Einsatzbedingungen
- Einsatzmöglichkeiten: Tourenwagen, GT, Rally, Einsitzer
- Durchschnittlicher Reibungskoeffizient bei 0,48
- Temperaturbereich 200 – 650 Grad C

日本語

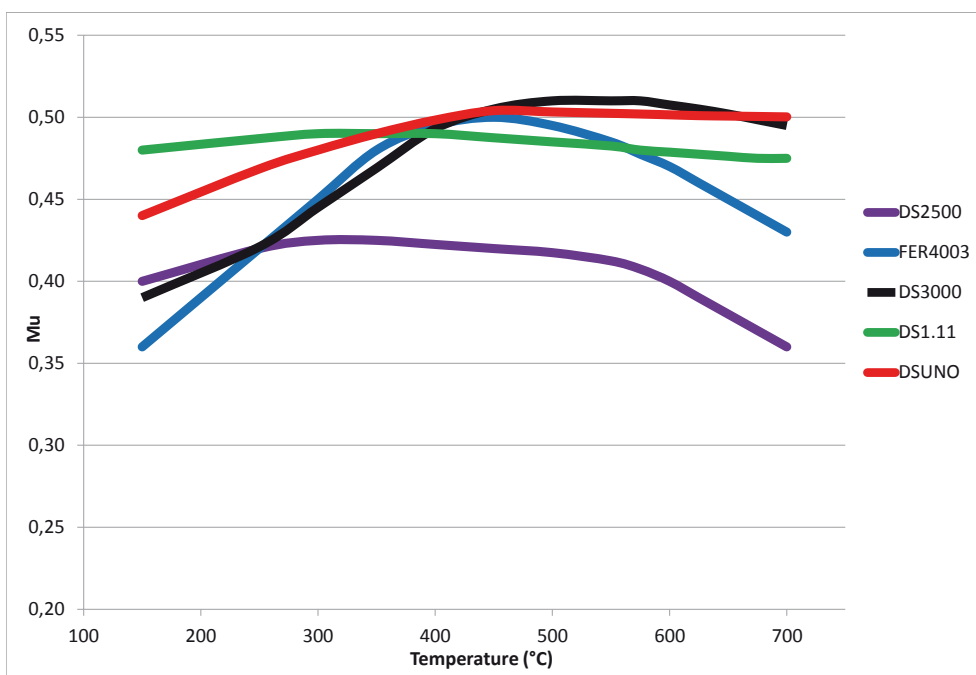
**DS1.11 (W/WB)**

- 重量級の耐久仕様の摩擦材
- 適用車種：セダン～GT、レーシングカー
- 平均摩擦係数 0.46, 温度範囲 200°-700°C
- 高耐久性能、
- ディスクへの低攻撃性

DSUNO (Z/ZB)

- 重量級のシヨートコース～耐久レース用摩擦材
- 適用車種：セダン～GT、レーシングカー
- 平均摩擦係数 0.48, 温度域 200°-700°C
- パワーのある車両にも優れたコントロール性能を發揮
- ディスクへの低攻撃性
- 高耐久性能

DS2500 (H)

- ストリート～サーキット走行用として幅広い車種に使用可能
- 耐久性、制動力、耐熱性をバランスよく設定しレース用の摩擦材でありながら一般道路用にも使用できるようにアレンジ
- 20°-500°C の温度域における平均摩擦係数 0.42

DS3000 (R)

- 軽量級～重量級まで車重量を選ばないオールラウンドな適用性
- セダン、ラリーカー、レーシングカー用と多くの車種に対応
- 平均摩擦係数 0.48, 温度域 200°-650°C

FER4003 (C)

- 特にフォーミュラーカーのライトウェイト向け/セミレーシング用摩擦材
- 適用車種：フォーミュラーカー、ラリーカー
- 平均摩擦係数0.46, 温度域 200°-450°C
- 短時間のあたりつけ
- 優れたブレーキタッチ
- 引きずりが少なく優れたリリース性能
- 優れたコントロール性能（ホイールロック防止）

中文

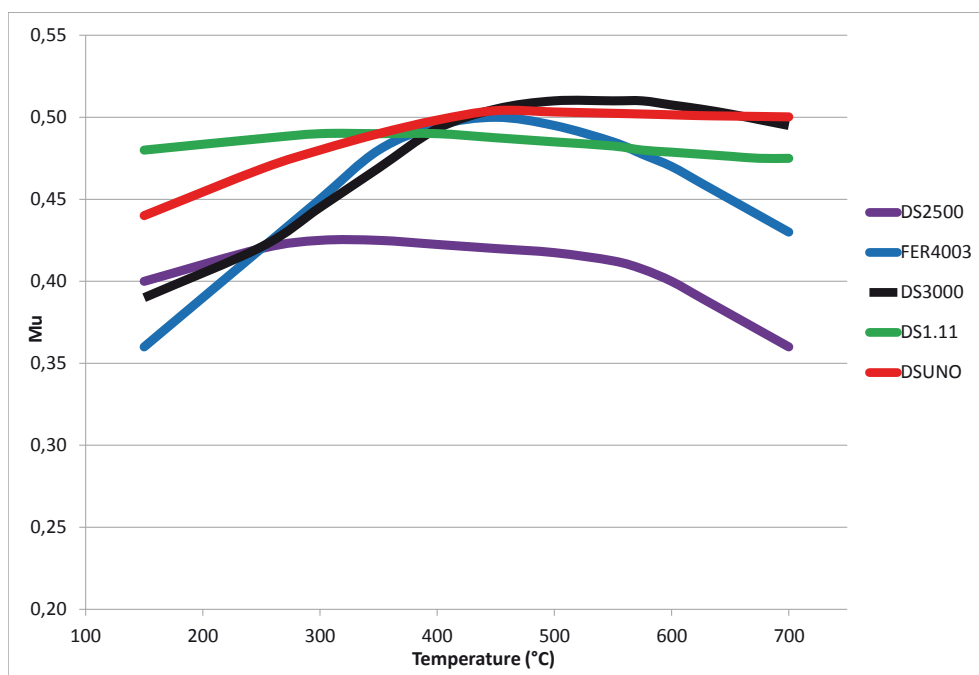

DS1.11 (W/WB)

- 長途賽事或耐力賽專用剎車皮
- 適合-房車賽, 超級房車賽
- 平均摩擦系數 0.46, 最佳工作溫度 200~700°C
- 壽命特長
- 不損剎車碟

DSUNO (Z/ZB)

- 制動力至強的比賽用剎車皮
- 適合-房車賽, 超級房車賽, 拉力賽
- 平均摩擦系數 0.48, 最佳工作溫度 200~700°C
- 操控感特強
- 不損剎車碟
- 耐用性高

DS2500 (H)

- 適合一般車輛用作街道快走和 TRACK DAY 使用
- 擁有原廠皮的舒適度, 以及賽車皮的耐熱及制動效能
- 平均摩擦系數0.42, 最佳工作溫度 20~500°C

DS3000 (R)

- 標準型競賽用剎車皮
- 適合-房車賽, 拉力賽
- 平均摩擦系數 0.48, 最佳工作溫度 200~650°C

FER4003 (C)

- 方程式賽車專用剎車皮
- 適合-方程式賽車和輕型車種
- 平均摩擦系數 0.46, 最佳工作溫度 200~450°C
- 磨合迅速
- 初期制動力特強
- 超低阻力
- 操控敏銳

Bedding of Race Pads

The aim is to bring the pads to full race temperatures, but slowly (too quick bedding results in glazing). This is done by a series of laps where full speeds may be attained but lighter braking pressures are used (i.e. the driver applies the brakes earlier). It is important that the pads are allowed to cool after the bedding process before racing. Ideally the pads will arrive at temperatures in excess of 500°C during the bedding. Pads smoking during the cool-down is not a cause for concern. Specifically for DS1.11 and DSUNO temperatures should arrive at between 500°C and 700°C (as an indication: green and orange thermal paints applied to discs to turn white completely).

Perform at least 15 trial brake applications, initially with reduced pressures (50% of the normal that might be used for that same brake application were it to occur under race conditions) building up to full decelerations after the 15 applications. To shorten the procedure applications can be made along the straights as well as at corners.

On completion of the trial applications, return to the pit lane. Inspect the surface of the brake pads from the two wheels that have been working the hardest. There should be evidence of contact over the full pad area, but without glazing. The pads are now ready to race. Whilst it is recommended that pads are inspected after bedding, if time does not allow this and paragraph 1 has been carried out appropriately, so long as a short period of time has elapsed to allow the brake system to cool (ideally to below 100°C – this might take in excess of five minutes), the pads will be ready to race.

Rodage de plaquettes de course

L'objectif est d'amener les plaquettes aux températures maximales de course, mais lentement (le rodage trop rapide entraînant un glaçage). Cela se fait par une série de tours où les vitesses maximales peuvent être obtenues, mais en utilisant une pression de freinage inférieure (c.-à-d. le conducteur freine plus tôt). Il est important que les plaquettes puissent refroidir après le rodage et avant la course. Idéalement les plaquettes arriveront à des températures supérieures à 500°C au cours du rodage. Les plaquettes fumeront lors du refroidissement, cela est normal. Pour les DS1.11 et DSUNO, les températures doivent atteindre entre 500°C et 700°C (à titre indicatif: les peintures thermiques verte et orange appliquées aux disques doivent blanchir complètement).

Effectuer au moins 15 freinages de rodage, d'abord avec des pressions réduites (50% de la pression normale en course) jusqu'à des pressions complètes pour les 15 freinages suivants, et ce toutes les 30 secondes maximum. Pour raccourcir le délai de rodage vous pouvez faire les freinages de rodage en ligne droite ainsi qu' en courbe, et pas nécessairement dans des zones de freinage du parcours.

À l'issue du rodage, revenir aux stands. Inspectez la surface des plaquettes de frein des deux roues les plus en contrainte. Il doit y avoir des preuves de contact sur la surface complète de la plaquette (ou au moins 80%), mais sans apparentes traces de glaçage.

Les plaquettes sont maintenant prêtes pour la course. Bien qu'il soit recommandé d'inspecter les plaquettes après la séance de rodage, si le temps ne le permet pas et que la procédure de rodage ait été correctement faite, attendre un court laps de temps pour permettre au système de freinage de refroidir (idéalement en dessous de 100°C - ce qui peut prendre environ cinq minutes), les plaquettes seront alors prêtes pour la course.

Rodaggio di Pastiglie Racing

L'obiettivo in fase di rodaggio è di portare la temperatura delle pastiglie che si avrebbe in condizione di gara ma in modo graduale (se la procedura verrà effettuata in modo troppo rapido si potrà avere il fenomeno della vetrificazione superficiale). Per conseguire tale obiettivo si potranno svolgere test ad alta velocità, utilizzando pressioni di circa il 50% rispetto alle condizioni gara. Mai usare acceleratore e freno allo stesso momento. E' importante che le pastiglie, dopo il rodaggio, possano avere il tempo di raffreddarsi prima di essere utilizzate in gara. Idealmente le pastiglie dovrebbero arrivare durante tale procedura a temperature intorno ai 500°C. Il fatto che le pastiglie fumino durante la fase di rodaggio non significa che il prodotto abbia un problema. Specifico per il rodaggio delle mescole DS1.11 e DSUNO è che la temperatura arrivi a 500°C e non superi i 700°C. (se usate le vernici termo viranti sui dischi, dovrete vedere virare completamente il verde e l'arancione).

Effettuate circa 15 frenate alla metà della pressione che usereste in gara e mantenetele per più tempo rispetto a situazioni di gara. Dopo le iniziali 15 frenate (circa 30 secondi tra una e l'altra) potrete iniziare a raggiungere la massima decelerazione del veicolo (sempre circa 15 frenate). Per accorciare i tempi di rodaggio, queste frenate potranno essere effettuate anche sul dritto e non necessariamente solo nei punti di frenata del circuito.

Terminati questi cicli di frenate tornate nella pit lane per ispezionare le pastiglie. Dovrete vedere che la superficie del materiale d'attrito sia completamente in contatto con il disco (almeno l'80% della stessa) e che non ci siano evidenti problemi di vetrificazione. A questo punto le pastiglie sono pronte per la gara o i test che dovrete effettuare. Nonostante consigliamo l'ispezione delle pastiglie dopo il rodaggio, se il tempo a disposizione non lo consentisse, ma avete espletato la procedura consigliata, sentitevi tranquilli di poter gareggiare ed avere la massima efficacia frenante dal prodotto.

Rodaje Pastilla Racing

El objetivo de la fase de rodaje es la de poner la pastilla en temperatura como la que va a tener en condiciones de carrera pero de un modo gradual (si el procedimiento se realiza de modo muy rápido puede aparecer el fenómeno de cristalización superficial). Para conseguir tal objetivo se podrá realizar a alta velocidad, utilizando una presión de cerca del 50% respecto a las condiciones de carrera. No utilizar nunca el acelerador y el freno al mismo tiempo. Es importante que las pastillas tengan el tiempo suficiente de refrigeración antes de su utilización en carrera. El hecho de que las pastillas produzcan humo durante la fase de rodaje no significa que el producto tenga problemas. El rodaje específico para la calidad DS1.11 y DSUNO es que la temperatura de la pastilla sea superior a 500°C pero no superior a 700°C (Si utiliza las pinturas de análisis de temperatura en los discos el color verde y el naranja deben cambiarse completamente).

Effectuar cerca de 15 frenadas a la mitad de la presión que se realiza normalmente en carrera y mantenerla por mas tiempo que en situación de carrera. Despues de las iniciales 15 frenadas (cerca de 30 segundos entre una y otra) podrá llegar a tener la máxima deceleración del vehículo (siempre cerca de 15 frenadas). Para acortar el tiempo de rodaje, estas frenadas podrán ser realizadas incluso en línea recta no teniendo que realizarse necesariamente en los puntos de frenada del circuito.

Terminado este ciclo de frenadas volver a la línea de Pit lane para inspeccionar las pastillas. Deberá ver que la superficie del material de fricción ha estado en contacto con la superficie del discos (al menos del 80% de la superficie) y que no se vean signos evidentes de cristalización. Llegado a este punto las pastillas están rodadas para la carrera o test. No obstante recomendamos la inspección de las pastillas después del rodaje si el tiempo que disponemos nos lo permite, pero el proceso se ha conseguido, puedes estar tranquilo de poder tener la máxima eficacia de frenada del producto.

Einfahren Von Renn-Bremsbelägen

Das Ziel ist, die Beläge auf volle Renntemperatur zu bringen, aber langsam (zu schnelles Einfahren bewirkt Verglasung). Dies geschieht in einer Reihe von Runden, wo volle Geschwindigkeit erreicht werden kann, jedoch mit leichteren Bremsvorgängen (der Fahrer bremst früher). Es ist wichtig, dass die Beläge nach dem Einfahren abkühlen können, bevor das Rennen startet. Idealerweise erreichen die Temperaturen mehr als 500°C während des Einfahrens. Rauchende Beläge während des Abkühlens sind kein Grund zur Sorge. Speziell bei den DS1.11 und DSUNO sollten die Temperaturen zwischen 500°C und 700°C liegen (als Hinweis: grüne und orange Thermofarbe auf den Scheiben sollte komplett weiß werden).

Machen Sie wenigsten 15 Bremsvorgänge, anfangs mit reduziertem Druck (50% des normalen, bei gleichem Bremsvorgang unter Rennbedingungen) bis zum vollständigen Abbremsen nach 15 Vorgängen. Um das Einfahren abzukürzen, kann dies sowohl auf gerader Strecke als auch in Kurven erfolgen.

Nach Abschluss der Bremsversuche kehren Sie in die Boxengasse zurück. Untersuchen Sie die Oberfläche der Bremsbeläge der beiden Räder, die am härtesten beansprucht worden sind. Es sollten über die gesamte Bremsbelagsfläche Kontaktsuren zu sehen sein, jedoch ohne Verglasung. Die Beläge sind rennfertig. Obwohl empfohlen wird, die Beläge nach dem Einfahren zu untersuchen, die Zeit fehlt, jedoch §1 sorgfältig ausgeführt wurde und sofern kurze Zeit vergangen ist, um das Bremssystem zu kühlen (idealerweise unter 100°C – geschieht in ca. 5 Minuten), können die Beläge im Rennen eingesetzt werden.

競賽煞車片的磨合

目標是以循序漸進的方式把煞車片提升至比賽溫度，以鞏固及提升煞車片的性能。(太快速的磨合會令煞車片的表面磨成光滑，仿似鏡面，影響效能。)

競賽煞車片的磨合最好是在賽車場上跑兩三圈來完成。駕駛方法及速度跟平常一樣，而最重要的就是「提早煞車」（並將煞車力度減至平常的一半，即約50%）。

重覆以上煞車動作15次。下一步是以漸進式增加煞車的力度(約10次)，直至力度恢復到平常一樣(即100%)。當煞車片的溫度提升至超過500°C，再經過冷卻之後，整個磨合過程便已完成！(DS1.11及DSUNO的磨合溫度比一般更高，達500至700°C。此時塗在煞車碟上的綠色及橙色溫度漆均已變成白色。)

如時間許可，當完成磨合過程之後，將車駛回維修站通道，檢查煞車片是否已完全磨合(全面接觸)，並且沒有產生光面。但是如果時間緊迫，只需於完成磨合之後，給大約15分鐘時間煞車片冷卻至100°C以下，便可以進行比賽！

レーシングパッドの慣らし

慣らしの目的はパッドの温度をレース本番相当に上げることです。ただしゆっくりと行います（急激に温度を上げると表面硬化してしまい、性能劣化を引き起こします）

サーキットで徐々に速度を上げていき、軽めの踏力でブレーキングを始めてください。

最終的にはフルスピードからのブレーキングを行います。その後、走行しながら冷却して下さい。

慣らしの間に、パッド温度が500°C位になるのが理想的で、冷却中に煙が出てくるのは問題ありません。特にDS1.11とDSUNOの場合は500°Cから700°Cくらいの間に

なるのが理想です。それはサーモペイントの緑、オレンジが完全に变色する状態です。

15回程、軽めのブレーキングを行います（レース本番の50%程の踏力）

慣らしを早めに行うためにストレートでブレーキングしてもかまいません。

その後、ピットに戻り、過激に使われている左右のパッドの表面を確認して下さい。

(通常フロントです)パッド全体に当たりが出て表面が硬化していなければ、完了です。

もし、パッドの確認ができない場合は、5分くらい冷やせば(100°C以下)大丈夫です。

SILOXANE

In the braking world, “Ceramic” is a word that is heard a lot. However “Ceramic” can merely indicate that the product contains something, anything, that is not “organic.” Organic means a substance whose molecular structure is largely based upon carbon. However for an engineer to understand a material as ceramic, he or she knows that this must mean that its performance defining core must be non-organic. In the case of a friction material this is the resin – the glue which holds the pad together; the matrix that holds the other components in place, allowing them to do their job. For over 100 years this job has been, and continues to be done in brake pads almost exclusively by a phenolic resin. A highly durable, versatile binder, yet resolutely an “organic” material.

The appeal of a non organic based brake pad is simple: Phenolic resins begin to decompose at temperatures above 300-400°C. In a racing pad, where these temperatures would be regarded as a operating minimum that’s bad news. It means the pads wears more as the carbonaceous material decomposes, that the pedal becomes spongy as the pad loses its rigidity and that the brake will fade, as gaseous decomposition products try to escape at the disc/pad interface. The problem is, no one had ever found a viable alternative to the phenolic based brake pad, aside from the sintered metal compounds. These latter materials work well in motorcycle racing, but the far higher weight of a car makes heat transfer to the caliper an almost insurmountable problem in auto racing. Additionally, as essentially an incompressible block of metal, sintered pads are often judged to lack the “feel” that a racing driver requires, being little more than an on/off switch for the brake.

However, in DS1.11 and DSUNO Ferodo Racing can offer a true “ceramic” race brake pad. The resin binding system replacing the traditional phenolic is described as a “Siloxane” In layman’s terms, this means that the 3D molecular network that holds the pad together is formed from chains of silicon rather than carbon atoms. These are impervious to temperature. In fact, at about 700°C, they actually undergo a chemical phase transition which actually pulls the pad together even more strongly. Additionally, the cured (i.e “set” during the manufacturing process) resin, being a hard, abrasive ceramic, has friction enhancing properties. So there’s a double benefit. No phenolic carbon to decompose so wear is low and an abrasive substructure that keeps the friction coefficient (μ) high!

DS1.11 is recommended for FIA GT, Touring Car, Formula cars, Group N and Stock Car (NASCAR) in the USA. DSUNO is used in rally applications and sprint races, though drivers who appreciate it’s very high friction have also been using it for touring car and group N applications too. Both are characterized by long life, high μ and a firm pedal under all conditions, but the torque profile of DS1.11 during a brake application is flat, whilst that of DSUNO rises, making them complementary compounds, depending on vehicle type and driver preference.

THE BACKGROUND: PERFORMANCE REQUIREMENTS

Whilst issues of Noise, Vibration and Harshness (problems associated and known in the industry by the generalised abbreviation “NVH”) have become of paramount importance for the braking of road vehicles, they are of little concern in racing. Broadly speaking the performance requirements on the track are as follows:

High Friction. Very high decelerations are required, often from systems that are not servoassisted. The combination of aerodynamic downforce and large, sticky tires means that the limiting factor in braking is often the force applied via the driver’s foot rather than road/tire adhesion. The requirement for maximum braking torque from the available muscle power means that materials with a high coefficient of friction μ are preferred - in other words those materials that translate the highest possible percentage of the applied force into vehicle deceleration No fade. Fade is the term used for a decrease in friction performance at high temperatures. High vehicles speeds, high decelerations, frequent brake applications and limited cooling (ducting air creates drag) means that discs and pads get very hot – upto 900°C. Yet μ must be maintained even under these extreme conditions.

Low pad compressibility. This results in shorter pedal travel, one of the driver’s key requirements. Ideally the pad compressibility will be the same at all temperatures and will not change throughout a race.

The “right” friction history. This is sometimes called “stop shape” or “time history” and refers to how the friction coefficient varies through a brake application. As such it is the response of the braking system to increasing temperature with decreasing speed. This is as close to an objective description of the hard-to-define brake “feel” as is possible to make.

Generally speaking, drivers of cars with greater downforce prefer a flat response (this is because the last thing a driver needs is friction ramping up at the apex of the bend, just as downforce is reducing due to his lower speed: result; wheel lock!) whereas those vehicles with less downforce often prefer rising friction through the stop. DS1.11 is an example of a material with a flatter stop shape, whilst DSUNO has a rising torque output (see graph) Initial bite. How quickly the brake responds to the driver’s pedal. Almost exclusively, the quicker the better.

Pad and Disc life. Not always important but vital in endurance racing where the number of pit-stops must be minimised and, not least, economically in that fewer disc and pad changes means fewer disc and pad purchases.

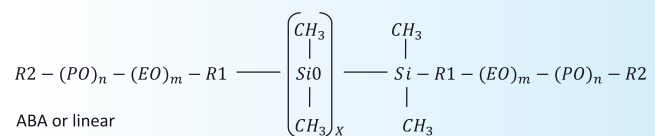

Where R2= OH, OR, acetate

Generalized chemical structure of siloxane.



All fluids are of Glycol based ether composition, and are suitable for brake and clutch use. Additionally they have the following characteristics:

		DOT5.1	Ferodo Formula	Ferodo Super Formula
Technical Details: Typical measured values	Dry boiling point (°C)	270	310	328
	Wet boiling point (°C)	185	205	200
	Kinematic Viscosity (cSt)	800	1650	1500
Availability	0,25 litre Box = 24 bottles	FBZ025	n/a	n/a
	0,50 litre Box = 24 bottles	FBZ050	DSF050	FSF050
	1 litre Box = 12 bottles	FBZ100	n/a	n/a
	5 litres Box = 4 bottles	FBZ500	n/a	n/a

Bottles are sold in complete boxes only

WARNING:

Recommended for use by experienced mechanics only

Contains polyalkylene glycol ether and other esters. Keep out of reach of children. Avoid excessive skin contact. If swallowed, seek medical advice and show the container. In case of eye contact, flush with water for 10 minutes.

DOT5.1

- Recommended for road use
- Adheres to DOT 5.1 specification
- Low viscosity means ideally suited for ABS/ESP braking systems
- Low viscosity down to -40°C allows use under all conditions
- Available in 4 bottle sizes
- Low corrosion
- Very low rubber swell

Ferodo Formula

- Recommended for track day & race use
- High wet and dry boiling point
- Low corrosion
- Low rubber swell
- Low viscosity for a race fluid (falls within DOT 4 road spec allowing road use)

Ferodo Super Formula

- Premium Product
- Recommended for race use
- Market leading high wet and dry boiling point
- Very low corrosion, with additives to render more compatible with Mg components
- Low rubber swell
- Super-low viscosity for a race fluid of such high B.pt. (falls within DOT 4 road spec allowing road use)
- Super high lubricity → reduces clutch component wear even in problem applications.



FERODO[®]

PRODUCT RANGE



FERODO[®]

RACING

Car Racing Pads Products Range

Part Number	DS2500	4300	DS3000	DS 1.11	DS 1.11 (THERMALLY BEDED)	DSUNO	DSUNO (THERMALLY BEDED)
	H	C	R	W	WB	Z	ZB
FCP2	✓	✗	✓	✗		✗	
FCP3	✓		✓	✗			
FCP9	✓		✓				
FCP11	✓		✓	✗		✓	
FCP22	✓						
FCP29	✓		✓				
FCP39		✗					
FCP72	✓		✓				
FCP93	✓		✓				
FCP96	✓		✓				
FCP105			✗				
FCP116	✓		✓			✗	
FCP167	✓	✓	✓	✗		✓	
FCP170		✓					
FCP173	✓		✓				
FCP206	✓		✓			✗	
FCP253	✗						
FCP256	✓		✓				
FCP276			✓				
FCP296	✓		✓	✗			
FCP308	✓		✓				
FCP342	✓	✓	✓	✗		✓	
FCP351	✓		✓			✓	
FCP360	✓						
FCP370	✓	✗	✓	✗		✓	
FCP372	✓		✗	✗			
FCP385	✗						
FCP392	✓		✓	✗			
FCP393	✓		✓				
FCP399	✓		✓				
FCP406	✓		✓			✓	
FCP408	✓		✓			✗	
FCP409	✓		✓				
FCP415	✓		✓				
FCP419	✓						
FCP434	✓		✗				
FCP441	✓	✗	✓				
FCP448	✓		✓				
FCP451	✓		✓	✗		✓	
FCP461	✓		✓				
FCP472	✓						
FCP483	✓		✓			✗	
FCP484	✓	✗	✗				
FCP487	✓		✗				
FCP519			✗	✗			
FCP524			✓				
FCP527	✓		✓				
FCP535	✓	✗	✓				
FCP541	✓		✓	✗		✗	
FCP546	✓		✓				
FCP558	✓	✗	✓				
FCP560	✓		✓	✗			
FCP565	✓		✓	✓			
FCP578	✓		✓	✗			
FCP584	✓		✓				
FCP586	✓		✓				
FCP590	✓		✓	✗			
FCP596	✓		✓				
FCP598	✓		✓				
FCP600	✓		✗				
FCP602	✓		✗				
FCP613	✓		✓				
FCP617	✓						
FCP638	✓						

Part Number	DS2500	4300	DS3000	DS 1.11	DS 1.11 (THERMALLY BEDED)	DSUNO	DSUNO (THERMALLY BEDED)
	H	C	R	W	WB	Z	ZB
FCP646	✓			✗			
FCP647	✗						
FCP653							
FCP660	✓		✓	✗			
FCP685	✓		✓				
FCP691	✓		✓				
FCP721	✓		✓	✗			
FCP725	✓		✓	✓			
FCP726	✓		✓				
FCP732	✓		✓				
FCP748	✓						
FCP761	✗						
FCP765	✓		✓	✓		✓	
FCP766	✗		✗				
FCP767			✗				
FCP774	✓	✗	✓				
FCP775	✓		✓				
FCP776	✓		✓			✗	
FCP777	✓						
FCP779	✓		✓	✗			
FCP789	✓		✓				
FCP790	✓		✓				
FCP809	✓	✓	✓	✗		✓	
FCP810	✓	✗	✓	✗		✗	
FCP815	✓	✗	✓	✗			
FCP817	✓		✓				
FCP823			✗	✗			
FCP825	✓	✓	✓	✓		✓	
FCP832	✓		✓				
FCP840		✗	✓				
FCP845	✓	✓	✓	✗			
FCP850	✓		✓	✓		✓	
FCP856	✓		✗				
FCP857	✓		✓	✗			
FCP859	✗		✓				
FCP867	✓						
FCP876	✓		✓				
FCP878	✓		✓				
FCP881	✗						
FCP891	✓		✓	✗			
FCP904	✓						
FCP905	✓		✓				
FCP925	✓		✓				
FCP948	✓		✓				
FCP956	✓		✓	✗			
FCP986	✓		✓	✗		✓	
FCP995	✓						
FCP997			✗				
FCP1001	✓					✓	
FCP1011	✓		✗				
FCP1012	✓						
FCP1021	✓						
FCP1049	✓						
FCP1050	✓						
FCP1052	✓		✓				
FCP1054	✓						
FCP1056	✓						
FCP1063	✓		✓				
FCP1068	✓						
FCP1073	✓			✓		✗	
FCP1081	✓		✓				
FCP1082	✓		✗				
FCP1093	✓		✗				
FCP1094	✓		✗			✗	

Part Number	DS2500	4300	DS3000	DS 1.11	DS 1.11 (THERMALLY BEDED)	DSUNO	DSUNO (THERMALLY BEDED)
	H	C	R	W	WB	Z	ZB
FCP1101	✗		✗				
FCP1112	✓						
FCP1113	✓		✓				
FCP1133	✓	✗	✓				
FCP1134	✓		✗				
FCP1160	✓						
FCP1162	✓						
FCP1213	✗						
FCP1224	✗		✗				
FCP1280	✓		✓	✗			
FCP1281	✓		✓	✓			
FCP1283			✓				
FCP1285	✓		✓				
FCP1288	✗						
FCP1289	✗						
FCP1293	✓						
FCP1294	✗						
FCP1295	✓						
FCP1298	✓		✓	✗		✗	
FCP1300	✓						
FCP1301	✓		✗				
FCP1307	✓		✓	✓			
FCP1308	✓		✓	✓			
FCP1312	✓					✗	
FCP1318	✓		✗				
FCP1319	✓						
FCP1323	✓						
FCP1324	✓						
FCP1327	✓		✗				
FCP1333	✓		✓				
FCP1334	✓		✓	✓		✓	
FCP1348	✓		✓	✓		✓	
FCP1349	✓		✗				
FCP1368	✓		✗				
FCP1370	✓		✓				
FCP1372	✓		✓				
FCP1376	✓		✓				
FCP1378	✓		✓				
FCP1382	✗						
FCP1392	✓						
FCP1394	✓		✓				
FCP1399	✓		✓			✗	
FCP1419	✓		✓				
FCP1424	✓						
FCP1430	✓						
FCP1436	✗						
FCP1437	✗						
FCP1441	✓						
FCP1444	✓		✓	✓			
FCP1456	✓						
FCP1457	✓						
FCP1459	✓		✗				
FCP1466	✓		✗			✗	
FCP1467	✓		✓				
FCP1468	✓		✓			✓	
FCP1469	✓		✓				
FCP1483	✓		✗	✗		✗	
FCP1491	✓			✓			
FCP1499	✓		✓	✗			
FCP1501	✓		✗				
FCP1520	✓						
FCP1521	✓						
FCP1528	✓		✓				
FCP1540	✓						

Car Racing Pads Products Range

Part Number	DS2500	4300	DS3000	DS 1.11	DS 1.11 (THERMALLY BEDED)	DSUNO	DSUNO (THERMALLY BEDED)
	H	C	R	W	WB	Z	ZB
FCP1543	✓		✓				
FCP1553	✓						
FCP1560	✓		✓	✓			
FCP1561	✓		✓	✓		✓	
FCP1562	✓	✓	✓	✓		✓	
FCP1563	✓					✓	
FCP1568	✓		✓				
FCP1573	✓						
FCP1617			✓	✓		✓	
FCP1625	✓						
FCP1626	✓						
FCP1628	✓		✓	✓		✓	
FCP1629	✓						
FCP1631	✓						
FCP1636	✓		✓				
FCP1639	✓			✓		✓	
FCP1640	✓			✓		✓	
FCP1641	✓		✓	✓		✓	
FCP1655	✓						
FCP1661	✓						
FCP1664	✓		✓	✓			
FCP1667	✓		✓	✓		✓	✓
FCP1672	✓			✓		✓	
FCP1676	✓						
FCP1690	✓						
FCP1693	✓						
FCP1698	✓						
FCP1706	✓			✓			
FCP1717	✓						
FCP1725	✓		✓	✓		✓	
FCP1747	✓						
FCP1751	✓		✓				
FCP1765	✓			✓		✓	
FCP1773	✓						
FCP1783			✓				
FCP1786	✓						
FCP1790	✓		✓			✓	
FCP1795	✓			✓		✓	
FCP1805	✓						
FCP1806	✓						
FCP1807	✓						
FCP1808	✓						
FCP1858	✓						
FCP1859	✓						
FCP1862	✓						
FCP1894	✓						
FCP1917	✓						
FCP1931	✓			✓			
FCP1947	✓						
FCP1954	✓		✓				
FCP1975	✓			✓			
FCP1984	✓						
FCP4044	✓		✓				
FCP4045	✓						
FCP4050	✓						
FCP4064	✓						
FCP4080	✓			✓			
FCP4081	✓						
FCP4168	✓		✓			✓	
FCP4172	✓						
FCP4173	✓						
FCP4187	✓			✓			
FCP4191	✓						
FCP4217	✓		✓			✓	

Part Number	DS2500	4300	DS3000	DS 1.11	DS 1.11 (THERMALLY BEDED)	DSUNO	DSUNO (THERMALLY BEDED)
	H	C	R	W	WB	Z	ZB
FCP4218	✓						
FCP4223	✓						
FCP4249	✓						
FCP4262	✓			✓			
FCP4308	✓						
FCP4316	✓		✓				
FCP4327	✓						
FCP4353	✓						
FCP4354	✓						
FCP4379	✓						
FCP4381	✓						
FCP4394	✓						
FCP4404	✓						
FCP4412	✓						
FCP4413	✓						
FCP4416	✓						
FCP4425	✓						
FCP4426	✓		✓			✓	
FCP4430	✓						
FCP4433	✓					✓	
FCP4434	✓						
FCP4466	✓						
FCP4467	✓						
FCP4468	✓						
FCP4489	✓					✓	
FCP4587	✓						
FCP4611	✓			✓		✓	
FCP4612	✓			✓			
FCP4663	✓					✓	
FCP4664	✓			✓		✓	✓
FCP4665	✓					✓	✓
FCP4671	✓						
FCP4697	✓						
FCP4711	✓			✓			
FCP4712	✓					✓	
FCP4713	✓			✓			
FCP4805	✓					✓	
FCP4806	✓		✓				
FCP4816	✓						
FCP4821	✓						
FCP4830	✓			✓		✓	
FCP4835	✓					✓	
FCP4872	✓			✓		✓	
FCP4873	✓						
FCP4955	✓			✓			
FCP4972	✓						
FCP5030	✓			✓			
FRP101	✓		✓			✓	
FRP201	✓	✓	✓	✓		✓	
FRP202	✓	✓	✓				
FRP203	✓		✓			✓	
FRP212	✓		✓	✓		✓	
FRP216	✓	✓	✓	✓		✓	
FRP217	✓		✓	✓		✓	
FRP218	✓	✓	✓	✓		✓	
FRP219	✓	✓	✓	✓		✓	
FRP302	✓	✓	✓	✓		✓	✓
FRP308	✓	✓	✓	✓		✓	
FRP501	✓		✓	✓		✓	
FRP502	✓	✓	✓	✓			
FRP503	✓	✓	✓	✓			
FRP504	✓		✓	✓		✓	
FRP506	✓	✓	✓	✓			
FRP1058	✓		✓				

Part Number	DS2500	4300	DS3000	DS 1.11	DS 1.11 (THERMALLY BEDED)	DSUNO	DSUNO (THERMALLY BEDED)
	H	C	R	W	WB	Z	ZB
FRP1059			✗				
FRP1060			✓			✓	
FRP1061							
FRP1064			✓				
FRP1077	✓		✓	✓		✓	
FRP1078			✓	✗	✓	✗	✓
FRP1079	✓	✓	✓				
FRP3000	✓		✓	✓			
FRP3001	✗	✗	✗				
FRP3003	✓		✓	✓		✗	
FRP3004			✓				
FRP3006	✓						
FRP3007	✓					✓	
FRP3009			✓				
FRP3012			✓	✓			
FRP3014	✓		✓	✓		✗	✓
FRP3015				✓			
FRP3018	✓		✓	✗	✓	✓	
FRP3020			✓				
FRP3021		✓					
FRP3022			✓	✓			
FRP3023			✓				
FRP3024			✓	✓		✓	
FRP3025			✓				
FRP3026			✓				
FRP3027	✓						
FRP3028	✓		✓	✓		✓	
FRP3029	✓		✓	✓		✓	
FRP3030			✓			✓	
FRP3031			✓			✗	✓
FRP3032			✓			✓	
FRP3033			✓			✓	
FRP3034			✓				
FRP3035			✓				
FRP3037			✓				
FRP3039	✓		✓	✓		✗	✓
FRP3040			✓			✓	
FRP3042			✓	✓			
FRP3043			✓			✓	
FRP3044			✓			✓	
FRP3045			✓				
FRP3046			✓	✓			
FRP3050	✓		✓	✓			
FRP3051	✓		✓	✓			
FRP3053			✓	✓			
FRP3054	✓		✓	✓		✓	
FRP3055			✓	✓		✗	✓
FRP3056	✓	✓	✓			✓	
FRP3057	✓		✓	✓		✓	
FRP3058	✗		✓	⚠		✓	
FRP3059			✓	✗			
FRP3060			✗	✓			
FRP3061			✓	✓		✓	
FRP3062			✓	✓		✓	
FRP3067	✓		✓	✓		✓	
FRP3069	✓		✓	✓		✓	
FRP3070			✓	✓		✓	
FRP3071	✓	✓	✓	✓		✓	
FRP3073			✓	✓			
FRP3074			✓	✓			
FRP3075	✓		✓	✓		✗	✓
FRP3076	✓		✓	✓			
FRP3077	✓		✓	✓		✗	
FRP3078	✓		✓	✓		✓	

Car Racing Pads Products Range

Part Number	DS2500	4300	DS3000	DS 1.11	DS 1.11 (THERMALLY BEDED)	DSUNO	DSUNO (THERMALLY BEDED)
	H	C	R	W	WB	Z	ZB
FRP3080	✓		✓	✓		✓	
FRP3081	✓		✓	✎		✎	
FRP3082	✓		✓	✓		✓	
FRP3083	✓		✓	✓		✓	
FRP3084	✓		✓	✓		✓	✎
FRP3085	✓		✓	✓		✓	
FRP3086			✓	✓		✓	
FRP3087			✓	✓		✓	
FRP3088			✓	✗		✓	
FRP3091			✎				
FRP3092		✎		✓		✎	
FRP3094	✎			✓			
FRP3095	✓			✓		✗	✎
FRP3096	✓			✓		✗	✎
FRP3097	✓		✓	✓		✓	
FRP3098	✓		✓	✓		✓	
FRP3099	✓		✓	✓		✎	
FRP3100	✓		✎				
FRP3101						✓	
FRP3102				✓		✓	
FRP3103			✎	✎		✓	✎
FRP3104	✎	✓	✓				
FRP3105			✎				
FRP3106	✓		✓	✗	✓	✓	
FRP3107	✓		✓			✓	
FRP3108	✓					✓	
FRP3109	✎						
FRP3110			✎	✗	✓	✗	✓
FRP3112						✎	
FRP3113	✎		✓			✎	
FRP3114	✓		✓	✎			
FRP3115	✓		✎	✓			
FRP3116	✓		✓	✓		✓	
FRP3117			✓				
FRP3118				✓			
FRP3119						✓	
FRP3120	✓						
FRP3121	✓					✎	
FRP3122				✎			
FRP3123						✗	✓
FRP3126	✓						
FRP3127	✓						
FRP3128						✓	✎
FRP3129	✓						
FRP3130	✓			✎			
FRP3133	✓			✓		✎	
FRP3134	✓		✎			✓	
FRP3135	✓		✎			✎	
FRP3136	✓		✎				
FRP3137	✓			✎		✎	
FRP3138						✗	✎
FRP3139						✗	✎
FRP3140			✓			✓	
FRP3141	✓						
FRP3142	✓						
FRP3143	✎			✎		✗	✎
FRP3144	✓		✓	✗	✓	✗	✓
FRP3145			✎	✗	✎	✗	✓
FRP3146			✎				
FRP3147	✓			✓			
FRP3148	✓		✓				
FRP3149	✓		✓				
FRP3150							✎
FRP5001			✎	✎			

Part Number	DS2500	4300	DS3000	DS 1.11	DS 1.11 (THERMALLY BEDED)	DSUNO	DSUNO (THERMALLY BEDED)
	H	C	R	W	WB	Z	ZB
FRP5002			✓	✎			

Equivalent Ferodo Pad Shapes

Part Number	DIMENSIONS	ALSO AVAILABLE			
	Length x Height x Thickness (mm) - Radial depth (mm)	Shape	Th. mm	Shape	Th. mm
FCP22	109.0 x 39.0 x 10.0 mm Rd=36.0 mm	FCP29	17.3		
FCP29	108.9 x 39.0 x 17.3 mm Rd=37.0 mm	FCP22	10		
FCP116	77.6 x 66.0 x 16.5 mm Rd=50.1 mm	FRP3056	14.5	FCP1562	14.5
FCP351	108.9 x 47.0 x 18.0 mm Rd=42.4 mm	FCP360	12		
FCP360	108.9 x 47.0 x 12.0 mm Rd=42.4 mm	FCP351	18		
FCP392	138.0 x 49.3 x 15.3 mm Rd=45.3 mm / 138.0 x 51.4 x 15.3 mm Rd=45.3 mm	FCP419	19.7		
FCP419	138.0 x 49.3 x 19.7 mm Rd=45.3 mm / 138.0 x 51.4 x 19.7 mm Rd=45.3 mm	FCP392	15.3		
FCP451	97.9 x 65.0 x 18.0 mm Rd=50.8 mm	FRP3069	16		
FCP541	87.4 x 52.9 x 15.0 mm Rd=40.8 mm	FCP1491	16		
FCP558	105.2 x 54.8 x 11.0 mm Rd=42.0 mm	FCP881	15		
FCP721	109.8 x 69.0 x 17.3 mm Rd=51.3 mm	FCP1348	15	FRP3109	12.5
FCP774	119.0 x 70.0 x 16.2 mm Rd=47.5 mm	FCP775	19.6		
FCP775	119.0 x 70.0 x 19.6 mm Rd=47.5 mm	FCP774	16.2		
FCP857	123.2 x 59.4 x 17.0 mm Rd=54.8 mm	FCP1483	17.2		
FCP878	126.0 x 59.0 x 14.6 mm Rd=41.0 mm	FCP1560	12.9		
FCP881	105.2 x 58.0 x 15.0 mm Rd=42.0 mm	FCP558	11		
FCP891	131.8 x 75.0 x 17.5 mm Rd=66.0 mm	FRP3042	26.5		
FCP905	148.8 x 57.0 x 18.5 mm Rd=50.5 mm	FRP3062	19.5		
FCP1054	141.8 x 48.0 x 19.3 mm Rd=45.0 mm / 141.8 x 50.6 x 19.3 mm Rd=45.0 mm	FCP1101	17.3	FCP1288	15.3
FCP1101	141.6 x 50.3 x 17.3 mm Rd=45.0 mm / 141.6 x 51.2 x 17.3 mm Rd=45.0 mm	FCP1054	19.3	FCP1288	15.3
FCP1281	131.8 x 67.0 x 18.0 mm Rd=51.7 mm	FRP3028	16		
FCP1288	141.8 x 50.0 x 15.3 mm Rd=45.0 mm / 141.8 x 51.0 x 15.3 mm Rd=45.0 mm	FCP1054	19.3	FCP1101	17.3
FCP1289	119.0 x 69.0 x 19.9 mm Rd=47.5 mm	FCP1312	16		
FCP1312	119.0 x 69.0 x 16.0 mm Rd=47.2 mm	FCP1289	19.9		
FCP1334	131.8 x 77.2 x 16.0 mm Rd=61.0 mm	FRP3067	14.7		
FCP1348	109.8 x 69.0 x 15.0 mm Rd=51.3 mm	FCP721	17.3	FRP3109	12.5
FCP1399	137.0 x 50.8 x 19.0 mm Rd=42.9 mm	FRP3146	17.2		
FCP1483	123.0 x 59.4 x 17.2 mm Rd=59.4 mm	FCP857	17		
FCP1491	87.4 x 52.9 x 16.0 mm Rd=40.7 mm	FCP541	15		
FCP1560	126.0 x 59.0 x 12.9 mm Rd=41.0 mm	FCP878	14.6		
FCP1562	77.6 x 66.0 x 14.5 mm Rd=45.0 mm	FCP116	16.5	FRP3056	
FCP1667	124.8 x 70.7 x 15.5 mm Rd=52.1 mm	FCP4821	13.8		
FCP4611	114.74 x 91.2 x 18.1 mm Rd=71.3 mm	FCP4872	15		
FCP4821	124.8 x 70.7 x 13.8 mm Rd=52.1 mm	FCP1667	15.5		
FCP4872	114.5 x 91.2 x 15 mm Rd=71.3 mm	FCP4611	18.1		
FCP4972	113.8 x 59 x 14.5 mm Rd=46.1 mm	FRP3085	16.2		
FRP212	132.4 x 56.0 x 20.3 mm Rd=50.3 mm	FRP216	17		
FRP216	132.4 x 56.0 x 17.0 mm Rd=50.3 mm	FRP212	20.3		
FRP302	131.8 x 62.2 x 20.0 mm Rd=49.0 mm	FRP3007	18	FRP1078	25
FRP308	99.8 x 46.0 x 20.0 mm Rd=43.6 mm	FRP1079	16		
FRP501	133.0 x 71.0 x 20.0 mm Rd=43.0 mm	FRP3097			
FRP1058	79.8 x 56.0 x 18.0 mm Rd=45.5 mm	FRP1064	20		
FRP1059	84.8 x 68.0 x 22.0 mm Rd=51.5 mm	FRP3045	18	FRP3034	21
FRP1060	152.0 x 77.0 x 25.0 mm Rd=45.0 mm	FRP3000	18		
FRP1064	79.8 x 56.0 x 20.0 mm Rd=45.5 mm	FRP1058	18		
FRP1077	131.8 x 62.2 x 16.0 mm Rd=49.0 mm	FRP3007	18	FRP1078	25
FRP1078	131.8 x 62.2 x 25.0 mm Rd=49.0 mm	FRP3007	18	FRP1077	16
FRP1079	99.8 x 46.0 x 16.0 mm Rd=43.6 mm	FRP308	20		
FRP3000	152.0 x 77.0 x 18.0 mm Rd=45.0 mm	FRP1060	25		
FRP3003	152.1 x 80.0 x 18.0 mm Rd=54.0 mm	FRP3077	17	FRP3144	18
FRP3004	84.8 x 68.0 x 20.0 mm Rd=51.5 mm	FRP3045	18	FRP3034	21
FRP3007	131.8 x 62.2 x 18.0 mm Rd=49.0 mm	FRP1078	25	FRP1077	16
FRP3009	131.7 x 69.0 x 16.0 mm Rd=59.0 mm	FRP3012	20		
FRP3012	131.7 x 69.0 x 20.0 mm Rd=59.0 mm	FRP3009	16		
FRP3014	152.1 x 68.9 x 25.0 mm Rd=54.0 mm	FRP3077	17	FRP3144	18
FRP3015	152.1 x 68.9 x 28.5 mm Rd=54.0 mm	FRP3003	18	FRP3077	17

Equivalent Ferodo Pad Shapes

Part Number	DIMENSIONS	ALSO AVAILABLE			
	Length x Height x Thickness (mm) - Radial depth (mm)	Shape	Th. mm	Shape	Th. mm
FRP3018	132.4 x 55.0 x 16.7 mm Rd=42.0 mm	FRP3073	20.3		
FRP3020	86.2 x 63.0 x 15.0 mm Rd=46.0 mm	FRP3086	18		
FRP3022	79.8 x 62.0 x 20.0 mm Rd=50.5 mm	FRP3033	21	FRP3023	17.5
FRP3023	79.8 x 62.0 x 17.5 mm Rd=50.5 mm	FRP3022	20	FRP3033	21
FRP3024	139.8 x 61.4 x 20.0 mm Rd=48.4 mm	FRP3087	17.5	FRP3030	28
FRP3028	131.8 x 67.0 x 16.0 mm Rd=51.5 mm	FCP1281	18.2		
FRP3029	139.8 x 61.4 x 26.0 mm Rd=48.4 mm	FRP3024	20	FRP3087	17.5
FRP3030	139.8 x 61.4 x 28.0 mm Rd=48.4 mm	FRP3029	26	FRP3140	16
FRP3031	163.8 x 66.0 x 29.0 mm Rd=52.5 mm	FRP3110	25	FRP3123	21.5
FRP3032	131.8 x 61.0 x 16.0 mm Rd=42.5 mm	FRP3070	18		
FRP3033	79.8 x 62.0 x 21.0 mm Rd=50.5 mm	FRP3022	20	FRP3023	17.5
FRP3034	84.8 x 68.0 x 21.0 mm Rd=51.5 mm	FRP1059	22	FRP3045	18
FRP3037	163.1 x 69.0 x 28.0 mm Rd=54.0 mm	FRP3039	25	FRP3055	30
FRP3039	163.1 x 69.0 x 25.0 mm Rd=54.0 mm	FRP3055	30	FRP3037	28
FRP3042	131.8 x 75.0 x 26.5 mm Rd=66.0 mm	FCP891	17.5		
FRP3045	84.8 x 68.0 x 18.0 mm Rd=51.5 mm	FRP1059	22	FRP3034	21
FRP3054	152.0 x 80.0 x 18.0 mm Rd=51.0 mm	FRP3061	25	FRP3076	17
FRP3055	163.1 x 69.0 x 30.0 mm Rd=54.0 mm	FRP3039	25	FRP3037	28
FRP3056	77.6 x 66.0 x 14.5 mm Rd=50.1 mm	FCP1562		FCP116	16.5
FRP3061	152.0 x 80.0 x 25.0 mm Rd=51.0 mm	FRP3054	18	FRP3076	17
FRP3062	148.8 x 57.0 x 19.5 mm Rd=50.5 mm	FCP905	18.5		
FRP3067	131.8 x 77.0 x 14.7 mm Rd=62.0 mm	FCP1334	16		
FRP3069	97.9 x 65.0 x 16.0 mm Rd=50.8 mm	FCP451	18		
FRP3070	132.0 x 61.0 x 18.0 mm Rd=42.5 mm	FRP3032	16		
FRP3073	132.4 x 55.0 x 20.3 mm Rd=42.0 mm	FRP3018	16.7		
FRP3075	190.4 x 101.0 x 17.5 mm Rd=63.5 mm	FRP3096	19		
FRP3076	152.0 x 80.0 x 17.0 mm Rd=50.0 mm	FRP3054	18	FRP3061	25
FRP3077	152.1 x 80.0 x 17.0 mm Rd=54.0 mm	FRP3003	18	FRP3015	28.5
FRP3081	152.0 x 63.0 x 16.0 mm Rd=51.0 mm	FRP3142			
FRP3083	130.3 x 81.0 x 16.9 mm Rd=55.0 mm	FRP3107			
FRP3085	113.8 x 59.0 x 16.2 mm Rd=46.1 mm	FCP4972	14.5		
FRP3086	86.2 x 63.0 x 18.0 mm Rd=46.0 mm	FRP3020	15		
FRP3087	139.8 x 61.4 x 17.5 mm Rd=48.4 mm	FRP3030	28	FRP3029	26
FRP3095	130.2 x 70.0 x 19.0 mm Rd=60.4 mm	FRP3143	17.0		
FRP3096	190.4 x 101.0 x 19.0 mm Rd=63.5 mm	FRP3075	17.5		
FRP3097	133.2 x 61.0 x 20.4 mm Rd=43.0 mm	FRP501			
FRP3106	189.8 x 92.9 x 18.8 mm Rd=65.0 mm	FRP3133	16.5		
FRP3107	130.3 x 78.0 x 16.9 mm Rd=50.0 mm	FRP3083			
FRP3109	109.8 x 69.0 x 12.5 mm Rd=51.3 mm	FCP1348	15	FCP721	17.3
FRP3110	163.8 x 66.0 x 25.0 mm Rd=52.5 mm	FRP3123	21.5	FRP3031	29
FRP3123	163.8 x 66.0 x 21.5 mm Rd=52.5 mm	FRP3110	25	FRP3031	29
FRP3131	163.9 x 74.7 x 28.0 mm Rd=62.0 mm	FRP3150	30		
FRP3133	189.8 x 92.9 x 16.5 mm Rd=65.0 mm	FRP3106	18.8		
FRP3140	139.8 x 61.4 x 16.0 mm Rd=48.4 mm	FRP3087	17.5	FRP3024	20
FRP3142	152.1 x 63.8 x 16.0 mm Rd=50.8 mm	FRP3081			
FRP3143	130.2 x 70.0 x 17.0 mm Rd=60.4 mm	FRP3095	19.0		
FRP3144	152.1 x 68.9 x 18.0 mm Rd=54.0 mm	FRP3015	28.5	FRP3145	17
FRP3145	152.1 x 68.9 x 17.0 mm Rd=54.0 mm	FRP3144	18	FRP3014	25
FRP3146	137.0 x 50.8 x 17.2 mm Rd=42.9 mm	FCP1399	19.0		
FRP3150	163.9 x 74.7 x 30 mm Rd=62 mm	FRP3131	28		

A black and white photograph of a hand in a black racing glove pointing at a document. The document has a grid pattern, likely a technical drawing or a data table. The lighting is dramatic, with the hand and the document being the main focus against a dark background.

FERODO[®]

APPLICATIONS

FERODO[®]

RACING



KW

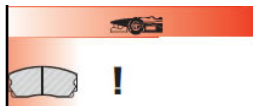

ABARTH

124 Spider

Model	Year	Month	Day	Direction	FCP	Brand	NOTE	FCP	Brand	NOTE
1.4	125	01/16		→				FCP1894	SUMITOMO	
1.4	125	09/16		→	FCP4821	BREMBO				

500 / 595 / 695 (312_)

1.4 (312.AXD1A)	99	08/08		→	FCP1467	BOSCH				
1.4 (312.AXD1A)	99	08/08		→				FCP1324	LUCAS/TRW	
1.4 (312.AXF11)	132	08/08		→	FCP1466	BOSCH				
1.4 (312.AXF11)	132	08/08		→	FCP1467	BOSCH				
1.4 (312.AXF11)	132	08/08		→	FCP1667	BREMBO				
1.4 (312.AXF11)	132	08/08		→				FCP1324	LUCAS/TRW	
1.4 (312.AXF11, 312.AXF1A, 312.AXD1A)	118	08/08		→	FCP1467	BOSCH				
1.4 (312.AXF11, 312.AXF1A, 312.AXD1A)	118	08/08		→				FCP1324	LUCAS/TRW	
1.4 (312.AXF11, 312.AXF1A, 312.AXD1A)	118	02/12		→	FCP4353	ATE				
1.4 (312.AXF1A)	103	05/10		→	FCP1466	BOSCH				
1.4 (312.AXF1A)	103	05/10		→	FCP1667	BREMBO				
1.4 (312.AXF1A)	103	05/10		→				FCP1324	LUCAS/TRW	
1.4 (312.AXT1A)	139	08/08		→	FCP1667	BREMBO				
1.4 (312.AXT1A)	139	08/08		→				FCP1324	LUCAS/TRW	
1.4 (312.AXY11, 312.AXY1A)	107	05/16		→	FCP1467	BOSCH				
1.4 (312.AXY11, 312.AXY1A)	107	05/16		→				FCP1324	LUCAS/TRW	
1.4 (312.AXZ11)	121	05/16		→	FCP1467	BOSCH				
1.4 (312.AXZ11)	121	05/16		→				FCP1324	LUCAS/TRW	

500C / 595C / 695C (312_)

1.4 (312.AXD1A)	99	01/11		→	FCP1467	BOSCH				
1.4 (312.AXD1A)	99	01/11		→				FCP1324	LUCAS/TRW	
1.4 (312.AXF11)	132	09/09		→	FCP1466	BOSCH				
1.4 (312.AXF11)	132	09/09		→	FCP1467	BOSCH				
1.4 (312.AXF11)	132	09/09		→	FCP1667	BREMBO				
1.4 (312.AXF11)	132	09/09		→				FCP1324	LUCAS/TRW	
1.4 (312.AXF1A)	103	09/09		→	FCP1467	BOSCH				
1.4 (312.AXF1A)	103	09/09		→				FCP1324	LUCAS/TRW	
1.4 (312.AXF1A, 312.AXD1A)	118	05/11		→	FCP1467	BOSCH				
1.4 (312.AXF1A, 312.AXD1A)	118	05/11		→				FCP1324	LUCAS/TRW	
1.4 (312.AXY1A)	107	05/16		→	FCP1467	BOSCH				
1.4 (312.AXY1A)	107	05/16		→				FCP1324	LUCAS/TRW	
1.4 (312.AXZ1A)	121	05/16		→	FCP1467	BOSCH				
1.4 (312.AXZ1A)	121	05/16		→				FCP1324	LUCAS/TRW	

GRANDE PUNTO (199_)

1.4 (199.AXN1B)	114	12/07	→ 06/10		FCP1667	BREMBO				
1.4 (199.AXN1B)	114	12/07	→ 06/10					FCP1858	BOSCH	
1.4 (199.AXX1B)	132	12/07	→ 12/12		FCP1667	BREMBO				
1.4 (199.AXX1B)	132	12/07	→ 12/12					FCP1858	BOSCH	

PUNTO (199_)

1.4 (199.AXX1B)	120	04/10	→ 02/12		FCP1667	BREMBO				
1.4 (199.AXX1B)	120	04/10	→ 02/12					FCP1858	BOSCH	
1.4 (199.AXX1B)	132	05/08	→ 02/12		FCP1667	BREMBO				
1.4 (199.AXX1B)	132	05/08	→ 02/12					FCP1858	BOSCH	

Punto EVO (199)

1.4 Supersport reg.	134	01/13	→		FCP1667	BREMBO				
---------------------	-----	-------	---	--	---------	--------	--	--	--	--

RITMO (138A_)

125 TC 2.0	92	11/81	→ 12/87		FCP370	LUCAS/TRW				
130 TC 2.0	96	04/83	→ 12/87		FCP370	LUCAS/TRW				

Strada

2.0 130	96	06/84	→ 06/87		FCP72	BENDIX				
2.0 130	96	06/84	→ 06/87		FCP370	LUCAS/TRW				

For material availability see page 16-18 / Per la disponibilità materiali vedere a pagina 16-18

1000

FERODO

RACING

Updated on 17th Aug 2018



KW

**AC****428**

4.1		01/67 → 12/74	FCP9	LUCAS/TRW				
4.1		01/67 → 12/74			FCP815	LUCAS/TRW		

Ace

5		01/93 →	FCP276	LUCAS/TRW				
---	--	---------	--------	-----------	--	--	--	--

Cobra

7		01/63 → 12/75	FCP9	LUCAS/TRW				
7		01/63 → 12/75			FCP815	LUCAS/TRW		

ME 3000

3.0 E,M	101	01/75 → 12/81	FCP167	LUCAS/TRW				
3.0 E,M	101	01/75 → 12/81			FCP815	LUCAS/TRW		

Superblower

4.9		01/97 →	FRP216	BREMBO				
-----	--	---------	--------	--------	--	--	--	--

ACURA**CL 4 cylinder**

2.2-2.3 L		01/97 → 12/99	FCP761	AKEBONO				
-----------	--	---------------	--------	---------	--	--	--	--

CL 6 cylinder

3.0 L		01/97 → 12/99	FCP905	AKEBONO				
-------	--	---------------	--------	---------	--	--	--	--

Integra

1.6-1.7-1.8 L		01/90 → 12/93	FCP748	AKEBONO				
1.6-1.8 L		01/94 → 12/01	FCP1436	AKEBONO				

Legend

3.2 L		01/91 → 12/95	FCP905	AKEBONO				
-------	--	---------------	--------	---------	--	--	--	--

Vigor

2.0-2.5 L		01/94 →	FCP905	AKEBONO				
-----------	--	---------	--------	---------	--	--	--	--

ALFA ROMEO**145**

1.3 i	66	09/94 → 09/96	FCP370	LUCAS/TRW				
1.3 i	66	09/94 → 09/96			FCP1113	LUCAS/TRW		
1.4	66	09/94 → 09/96	FCP370	LUCAS/TRW				
1.4	66	09/94 → 09/96			FCP409	LUCAS/TRW		
1.4 Twin Spark 16V	76	10/96 → 02/99	FCP1056	ATE				
1.4 Twin Spark 16V	76	10/96 → 02/99			FCP409	LUCAS/TRW		
1.6	76	09/94 → 11/96	FCP370	LUCAS/TRW				
1.6	76	09/94 → 11/96			FCP409	LUCAS/TRW		
1.6 Twin Spark 16V	88	01/97 → 02/99	FCP1056	ATE				
1.6 Twin Spark 16V	88	01/97 → 02/99			FCP409	LUCAS/TRW		
1.7 16V	95	09/94 → 09/00	FCP370	LUCAS/TRW				
1.7 16V	95	09/94 → 09/00			FCP409	LUCAS/TRW		
1.8 Twin Spark 16V	103	01/95 → 02/99	FCP1056	ATE				
1.8 Twin Spark 16V	103	01/95 → 02/99			FCP409	LUCAS/TRW		
1.9 JTD	77	01/99 → 09/00	FCP1056	ATE				
1.9 JTD	77	01/99 → 09/00			FCP409	LUCAS/TRW		
1.9 TD	68	09/94 → 11/96	FCP370	LUCAS/TRW				
1.9 TD	68	09/94 → 11/96			FCP409	LUCAS/TRW		
1.9 TD	68	12/96 → 12/99	FCP1056	ATE				
1.9 TD	68	12/96 → 12/99			FCP409	LUCAS/TRW		
2.0 Twin Spark 16V	110	01/96 → 02/99	FCP1052	ATE				
2.0 Twin Spark 16V	110	01/96 → 02/99			FCP409	LUCAS/TRW		

146

1.3 i	66	09/94 → 09/96	FCP370	LUCAS/TRW				
1.3 i	66	09/94 → 09/96			FCP1113	LUCAS/TRW		
1.4	66	09/94 → 09/96	FCP370	LUCAS/TRW				
1.4	66	09/94 → 09/96			FCP409	LUCAS/TRW		
1.4 Twin Spark 16V	76	01/96 → 02/99	FCP1056	ATE				
1.4 Twin Spark 16V	76	01/96 → 02/99			FCP409	LUCAS/TRW		
1.6	76	09/94 → 12/97	FCP370	LUCAS/TRW				
1.6	76	09/94 → 12/97			FCP409	LUCAS/TRW		
1.6 Twin Spark 16V	88	01/97 → 02/99	FCP1056	ATE				

For material availability see page 16-18 / Per la disponibilità materiali vedere a pagina 16-18



KW



ALFA ROMEO

146

				NOTE			NOTE
1.6 Twin Spark 16V	88	01/97 → 02/99			FCP409	LUCAS/TRW	
1.7 16V	95	09/94 → 12/97	FCP370	LUCAS/TRW			
1.7 16V	95	09/94 → 12/97			FCP409	LUCAS/TRW	
1.7 16V	95	01/97 → 09/00	FCP370	LUCAS/TRW			
1.7 16V	95	01/97 → 09/00			FCP409	LUCAS/TRW	
1.8 Twin Spark 16V	103	01/95 → 02/99	FCP1056	ATE			
1.8 Twin Spark 16V	103	01/95 → 02/99			FCP409	LUCAS/TRW	
1.9 JTD	77	01/99 → 09/00	FCP1056	ATE			
1.9 JTD	77	01/99 → 09/00			FCP409	LUCAS/TRW	
1.9 TD	68	09/94 → 12/96	FCP370	LUCAS/TRW			
1.9 TD	68	09/94 → 12/96			FCP409	LUCAS/TRW	
1.9 TD	68	01/96 → 12/99	FCP1056	ATE			
1.9 TD	68	01/96 → 12/99			FCP409	LUCAS/TRW	
2.0 Twin Spark 16V	110	01/96 → 02/99	FCP1052	ATE			
2.0 Twin Spark 16V	110	01/96 → 02/99			FCP409	LUCAS/TRW	

147 (937)

1.6 16V	88	01/01 → 03/10	FCP1134	ATE			
1.6 16V	88	01/01 → 03/10			FCP1349	LUCAS/TRW	
1.6 16V T.Spark Eco	77	01/01 → 03/10	FCP1134	ATE	For Solid brake disc		
1.6 16V T.Spark Eco	77	01/01 → 03/10	FCP1052	ATE	For Vented brake disc		
1.6 16V T.Spark Eco	77	01/01 → 03/10			FCP1349	LUCAS/TRW	
1.9 JTD	81	11/00 → 09/04	FCP1052	ATE			
1.9 JTD	81	11/00 → 09/04			FCP1349	LUCAS/TRW	
2.0 16V	110	10/00 →	FCP1052	ATE			
2.0 16V	110	10/00 →			FCP1349	LUCAS/TRW	
3.2 GTA	184	09/03 →	FCP1334	BREMBO			

155

1.6 i Twin Spark 16V	88	01/96 → 12/97	FCP370	LUCAS/TRW			
1.6 i Twin Spark 16V	88	01/96 → 12/97			FCP409	LUCAS/TRW	
1.7 i Twin Spark	85	02/92 → 03/93	FCP370	LUCAS/TRW			
1.7 i Twin Spark	85	02/92 → 03/93			FCP409	LUCAS/TRW	
1.8 i Twin Spark	95	02/92 → 04/96	FCP370	LUCAS/TRW			
1.8 i Twin Spark	95	02/92 → 04/96			FCP409	LUCAS/TRW	
1.8 i Twin Spark	95	02/92 → 04/96			FCP596	LUCAS/TRW	
1.9 TD	66	02/92 → 12/97	FCP370	LUCAS/TRW			
1.9 TD	66	02/92 → 12/97			FCP409	LUCAS/TRW	
1.9 TD	66	02/92 → 12/97			FCP596	LUCAS/TRW	
2.0 Q4 (Turbo) 16V	137	02/92 → 12/95	FCP565	LUCAS/TRW			
2.0 Q4 (Turbo) 16V	137	02/92 → 12/95			FCP409	LUCAS/TRW	
2.0 Q4 (Turbo) 16V	137	02/92 → 12/95			FCP596	LUCAS/TRW	
2.0 Q4 (Turbo) 16V	137	01/95 → 03/96	FCP1052	ATE			
2.0 Q4 (Turbo) 16V	137	01/95 → 03/96			FCP409	LUCAS/TRW	
2.0 Q4 (Turbo) 16V	137	01/95 → 03/96			FCP596	LUCAS/TRW	
2.0 TD	66	02/92 → 12/97	FCP565	LUCAS/TRW			
2.0 TD	66	02/92 → 12/97			FCP409	LUCAS/TRW	
2.0 Twin Spark	104	02/92 → 12/95	FCP370	LUCAS/TRW			
2.0 Twin Spark	104	02/92 → 12/95			FCP409	LUCAS/TRW	
2.0 Twin Spark	104	02/92 → 12/95			FCP596	LUCAS/TRW	
2.0 Twin Spark 16V	110	01/95 → 12/97	FCP1052	ATE			
2.0 Twin Spark 16V	110	01/95 → 12/97			FCP409	LUCAS/TRW	
2.0 Twin Spark 16V	110	01/95 → 12/97			FCP596	LUCAS/TRW	
2.5 TD	92	04/93 → 12/94	FCP565	LUCAS/TRW			
2.5 TD	92	04/93 → 12/94			FCP409	LUCAS/TRW	
2.5 TD	92	01/95 → 12/97	FCP1052	ATE			
2.5 TD	92	01/95 → 12/97			FCP409	LUCAS/TRW	
2.5 V6	121	02/92 → 12/95	FCP565	LUCAS/TRW			
2.5 V6	121	02/92 → 12/95			FCP409	LUCAS/TRW	
2.5 V6	121	02/92 → 12/95			FCP596	LUCAS/TRW	
2.5 V6	121	01/95 → 12/97	FCP1052	ATE			
2.5 V6	121	01/95 → 12/97			FCP409	LUCAS/TRW	
2.5 V6	121	01/95 → 12/97			FCP596	LUCAS/TRW	

156 (932)

1.6 i Twin Spark Saloon 16V	88	09/97 → 12/01	FCP1134	ATE			
1.6 i Twin Spark Saloon 16V	88	09/97 → 12/01			FCP995	LUCAS/TRW	
1.6 i Twin Spark Saloon 16V	88	01/02 → 09/05	FCP1134	ATE			
1.6 i Twin Spark Saloon 16V	88	01/02 → 09/05			FCP1349	LUCAS/TRW	
1.6 Twin Spark Sportwagon 16V	88	05/00 → 12/01	FCP1134	ATE			
1.6 Twin Spark Sportwagon 16V	88	05/00 → 12/01			FCP995	LUCAS/TRW	
1.6 Twin Spark Sportwagon 16V	88	01/02 → 05/06	FCP1134	ATE			
1.6 Twin Spark Sportwagon 16V	88	01/02 → 05/06			FCP1349	LUCAS/TRW	
1.8 i Twin Spark Saloon 16V	103	01/02 → 09/05	FCP1134	ATE			
1.8 i Twin Spark Saloon 16V	103	01/02 → 09/05			FCP1349	LUCAS/TRW	
1.8 Twin Spark Saloon 16V	103	01/97 → 12/01	FCP1134	ATE			
1.8 Twin Spark Saloon 16V	103	01/97 → 12/01			FCP995	LUCAS/TRW	

For material availability see page 16-18 / Per la disponibilità materiali vedere a pagina 16-18

1002

FERODO

RACING

Updated on 17th Aug 2018

ALFA ROMEO



KW

**...ALFA ROMEO****...156 (932)**

						NOTE				NOTE	
1.8 Twin Spark Sportwagon 16V	103	10/00	→ 12/01	FCP1134	ATE						
1.8 Twin Spark Sportwagon 16V	103	10/00	→ 12/01			FCP995	LUCAS/TRW				
1.8 Twin Spark Sportwagon 16V	103	01/02	→ 05/06	FCP1134	ATE						
1.8 Twin Spark Sportwagon 16V	103	01/02	→ 05/06			FCP1349	LUCAS/TRW				
1.9 JTD Saloon	77	09/97	→ 10/00	FCP1134	ATE						
1.9 JTD Saloon	77	09/97	→ 10/00			FCP995	LUCAS/TRW				
1.9 JTD Saloon	81	10/00	→ 05/01	FCP1052	ATE						
1.9 JTD Saloon	81	10/00	→ 05/01	FCP1134	ATE						
1.9 JTD Saloon	81	10/00	→ 05/01			FCP1349	LUCAS/TRW				
1.9 JTD Saloon	85	05/01	→ 12/01	FCP1052	ATE						
1.9 JTD Saloon	85	05/01	→ 12/01			FCP995	LUCAS/TRW				
1.9 JTD Saloon	85	01/02	→ 09/05	FCP1134	ATE						
1.9 JTD Saloon	85	01/02	→ 09/05			FCP1349	LUCAS/TRW				
1.9 JTD Saloon 16v	103	11/02	→ 09/05	FCP1052	ATE						
1.9 JTD Saloon 16v	103	11/02	→ 09/05	FCP1134	ATE						
1.9 JTD Saloon 16v	103	11/02	→ 09/05			FCP1349	LUCAS/TRW				
1.9 JTD Sportwagon	77	05/00	→ 10/00	FCP1134	ATE						
1.9 JTD Sportwagon	77	05/00	→ 10/00			FCP995	LUCAS/TRW				
1.9 JTD Sportwagon	81	10/00	→ 05/01	FCP1052	ATE						
1.9 JTD Sportwagon	81	10/00	→ 05/01	FCP1134	ATE						
1.9 JTD Sportwagon	81	10/00	→ 05/01			FCP1349	LUCAS/TRW				
1.9 JTD Sportwagon	85	05/01	→ 12/01	FCP1052	ATE						
1.9 JTD Sportwagon	85	05/01	→ 12/01			FCP995	LUCAS/TRW				
1.9 JTD Sportwagon	85	01/02	→ 05/06	FCP1134	ATE						
1.9 JTD Sportwagon	85	01/02	→ 05/06			FCP1349	LUCAS/TRW				
1.9 JTD Sportwagon 16v	103	11/02	→ 05/06	FCP1052	ATE						
1.9 JTD Sportwagon 16v	103	11/02	→ 05/06	FCP1134	ATE						
1.9 JTD Sportwagon 16v	103	11/02	→ 05/06			FCP1349	LUCAS/TRW				
2.0 i Twin Spark Saloon 16V	110	01/02	→ 03/02	FCP1052	ATE						
2.0 i Twin Spark Saloon 16V	110	01/02	→ 03/02			FCP1349	LUCAS/TRW				
2.0 i Twin Spark Sportwagon 16V	114	05/00	→ 10/00	FCP1052	ATE						
2.0 i Twin Spark Sportwagon 16V	114	05/00	→ 10/00			FCP995	LUCAS/TRW				
2.0 Twin Spark Saloon 16V	114	01/97	→ 10/00	FCP1052	ATE						
2.0 Twin Spark Saloon 16V	114	01/97	→ 10/00			FCP995	LUCAS/TRW				
2.0 Twin Spark Sportwagon 16V	110	01/02	→ 03/02	FCP1052	ATE						
2.0 Twin Spark Sportwagon 16V	110	01/02	→ 03/02			FCP1349	LUCAS/TRW				
2.4 JTD Saloon	100	01/97	→ 10/00	FCP1052	ATE						
2.4 JTD Saloon	100	01/97	→ 10/00			FCP995	LUCAS/TRW				
2.4 JTD Saloon	100	01/02	→ 09/05	FCP1052	ATE						
2.4 JTD Saloon	100	01/02	→ 09/05			FCP1349	LUCAS/TRW				
2.4 JTD Sportwagon	100	05/00	→ 10/00	FCP1052	ATE						
2.4 JTD Sportwagon	100	05/00	→ 10/00			FCP995	LUCAS/TRW				
2.4 JTD Sportwagon	103	01/02	→ 05/06	FCP1052	ATE						
2.4 JTD Sportwagon	103	01/02	→ 05/06			FCP1349	LUCAS/TRW				
2.5 i V6 Saloon 24V	140	05/00	→ 10/00	FCP1052	ATE						
2.5 i V6 Saloon 24V	140	05/00	→ 10/00			FCP995	LUCAS/TRW				
2.5 i V6 Saloon 24V	141	01/02	→ 09/05	FCP1052	ATE						
2.5 i V6 Saloon 24V	141	01/02	→ 09/05			FCP1349	LUCAS/TRW				
2.5 V6 Saloon 24V	140	01/97	→ 12/01	FCP1052	ATE						
2.5 V6 Saloon 24V	140	01/97	→ 12/01			FCP995	LUCAS/TRW				
2.5 V6 Sportwagon 24V	141	01/02	→ 05/06	FCP1052	ATE						
2.5 V6 Sportwagon 24V	141	01/02	→ 05/06			FCP1349	LUCAS/TRW				
3.2 GTA	184	03/02	→ 08/03	FCP721	BREMBO						
3.2 GTA	184	09/03	→	FCP1334	BREMBO						
3.2 Sportwagon GTA	184	09/03	→	FCP1334	BREMBO						

159 (939)

1.8 Tbi	147	05/09	→ 11/11	FCP1334	BREMBO						
1.8 Tbi	147	05/09	→ 11/11			FCP1795	LUCAS/TRW				
1.9 1.9 JTS	160	09/05	→	FCP1805	ATE						
1.9 JTDM 16V	110	09/05	→ 11/11	FCP1805	ATE						
1.9 JTDM 8V	88	09/05	→ 11/11	FCP1805	ATE						
2.2 2.2 JTS	185	09/05	→	FCP1805	ATE						
2.4 JTDM	147	09/05	→ 11/11	FCP1334	BREMBO						
2.4 JTDM	147	09/05	→ 11/11			FCP1795	LUCAS/TRW				
2.4 JTDM	154	05/07	→ 11/11	FCP1334	BREMBO						
2.4 JTDM	154	05/07	→ 11/11			FCP1795	LUCAS/TRW				
2.4 JTDM Q4	154	05/07	→ 11/11	FCP1334	BREMBO						
2.4 JTDM Q4	154	05/07	→ 11/11			FCP1795	LUCAS/TRW				
3.2 JTS	191	09/05	→	FRP3067	BREMBO						
3.2 JTS	191	02/08	→ 11/11	FCP1334	BREMBO						
3.2 JTS	191	02/08	→ 11/11			FCP1795	LUCAS/TRW				
3.2 JTS Q4	191	12/05	→ 11/11	FCP1334	BREMBO						
3.2 JTS Q4	191	12/05	→ 11/11			FCP1795	LUCAS/TRW				
3.2 V6 GTS		09/05	→	FRP3067	BREMBO						

For material availability see page 16-18 / Per la disponibilità materiali vedere a pagina 16-18



KW

**...ALFA ROMEO****159 (939_)**

1.8 MPI	103	03/07 → 11/11
1.9 JTDM 16V	100	09/05 → 11/11
1.9 JTDM 8V	85	09/05 → 11/11

FCP1805	ATE
FCP1805	ATE
FCP1805	ATE

NOTE

NOTE

159 Sportwagon (939)

1.8 TBi	147	05/09 → 11/11
1.8 TBi	147	05/09 → 11/11
2.4 JTDM	147	03/06 → 11/11
2.4 JTDM	147	03/06 → 11/11
2.4 JTDM	154	05/07 → 11/11
2.4 JTDM	154	05/07 → 11/11
2.4 JTDM Q4	154	05/07 → 11/11
2.4 JTDM Q4	154	05/07 → 11/11
3.2 JTS	191	02/08 → 11/11
3.2 JTS	191	02/08 → 11/11
3.2 JTS Q4	191	03/06 → 11/11
3.2 JTS Q4	191	03/06 → 11/11

FCP1334	BREMBO
FCP1334	BREMBO
FCP1334	BREMBO
FCP1334	BREMBO
FCP1334	BREMBO
FCP1334	BREMBO
FCP1334	BREMBO
FCP1334	BREMBO
FCP1334	BREMBO
FCP1334	BREMBO
FCP1334	BREMBO
FCP1334	BREMBO

FCP1795	LUCAS/TRW
FCP1795	LUCAS/TRW
FCP1795	LUCAS/TRW
FCP1795	LUCAS/TRW
FCP1795	LUCAS/TRW
FCP1795	LUCAS/TRW
FCP1795	LUCAS/TRW
FCP1795	LUCAS/TRW
FCP1795	LUCAS/TRW
FCP1795	LUCAS/TRW
FCP1795	LUCAS/TRW
FCP1795	LUCAS/TRW

159 Sportwagon (939_)

1.8 MPI	103	03/07 → 11/11
1.9 JTDM 16V	100	03/06 → 11/11
1.9 JTDM 16V	110	03/06 → 11/11
1.9 JTDM 16V	110	03/06 → 11/11
1.9 JTDM 8V	85	03/06 → 11/11
1.9 JTDM 8V	88	03/06 → 11/11
1.9 JTS	118	03/06 → 11/11
2.2 JTS	136	03/06 → 11/11
2.2 JTS	136	03/06 → 11/11

FCP1805	ATE
FCP1805	ATE
FCP1334	BREMBO
FCP1805	ATE
FCP1805	ATE
FCP1805	ATE
FCP1805	ATE
FCP1334	BREMBO
FCP1805	ATE

For TI equipment only

164

2.0 (Turbo)	148	01/92 → 02/95
2.0 (Turbo)	148	01/92 → 02/95
2.0 (Turbo)	150	07/87 → 12/92
2.0 (Turbo)	150	07/87 → 12/92
2.0 Twin Spark	106	07/87 → 06/89
2.5 TD	86	07/87 → 12/92
2.5 TD	86	07/87 → 12/92
2.5 TD	92	01/92 → 02/95
2.5 TD	92	01/92 → 02/95
2.5 V6	120	09/92 → 12/98
2.5 V6	120	09/92 → 12/98
3.0 V6 24V	132	01/92 → 02/95
3.0 V6 24V	132	01/92 → 02/95
3.0 V6 24V	141	07/87 → 12/92
3.0 V6 24V	141	07/87 → 12/92

FCP565	LUCAS/TRW
FCP565	LUCAS/TRW
FCP565	LUCAS/TRW
FCP565	LUCAS/TRW
FCP565	LUCAS/TRW
FCP565	LUCAS/TRW
FCP565	LUCAS/TRW
FCP565	LUCAS/TRW
FCP565	LUCAS/TRW
FCP565	LUCAS/TRW
FCP565	LUCAS/TRW
FCP565	LUCAS/TRW
FCP565	LUCAS/TRW
FCP565	LUCAS/TRW
FCP565	LUCAS/TRW

FCP596	LUCAS/TRW
FCP596	LUCAS/TRW
FCP596	LUCAS/TRW
FCP596	LUCAS/TRW
FCP596	LUCAS/TRW
FCP596	LUCAS/TRW
FCP596	LUCAS/TRW
FCP596	LUCAS/TRW
FCP596	LUCAS/TRW
FCP596	LUCAS/TRW
FCP596	LUCAS/TRW
FCP596	LUCAS/TRW
FCP596	LUCAS/TRW
FCP596	LUCAS/TRW
FCP596	LUCAS/TRW

166 (936)

2.0 Twin Spark 16V	114	08/98 → 10/00
2.0 V6 (Turbo)	151	08/98 → 10/00
2.0 V6 (Turbo)	151	08/98 → 10/00
2.4 JTD	100	08/98 → 10/00
2.4 JTD 20V	129	10/03 → 06/07
2.4 JTD 20V	129	10/03 → 06/07
2.5 24V	140	08/98 → 10/00
2.5 24V	140	08/98 → 10/00
3.0 24V	166	08/98 → 10/00
3.0 24V	166	08/98 → 10/00
3.2 i V6 24V	176	10/03 → 06/07
3.2 i V6 24V	176	10/03 → 06/07

FCP1334	BREMBO
FCP1334	BREMBO
FCP1334	BREMBO
FCP1334	BREMBO
FCP1334	BREMBO
FCP1334	BREMBO
FCP1334	BREMBO
FCP1334	BREMBO
FCP1334	BREMBO
FCP1334	BREMBO
FCP1334	BREMBO

FCP995	LUCAS/TRW
FCP995	LUCAS/TRW
FCP995	LUCAS/TRW
FCP995	LUCAS/TRW
FCP995	LUCAS/TRW
FCP995	LUCAS/TRW
FCP995	LUCAS/TRW
FCP995	LUCAS/TRW
FCP995	LUCAS/TRW
FCP995	LUCAS/TRW
FCP995	LUCAS/TRW

1750

1.7 GT	80	01/68 → 05/72
1.7 GT	80	01/68 → 05/72

FCP11	ATE
FCP11	ATE

FCP3	ATE
------	-----

2000

2.0	97	06/71 → 12/83
2.0	97	06/71 → 12/83

FCP11	ATE
FCP11	ATE

FCP3	ATE
------	-----

33

1.2	50	05/83 → 08/89
1.2	50	05/83 → 08/89
1.2	50	05/83 → 08/89
1.2	50	08/89 → 12/94
1.2	50	08/89 → 12/94
1.3	63	05/83 → 07/89
1.3	63	05/83 → 07/89

FCP441	ATE
FCP72	BENDIX
FCP441	ATE
FCP546	ATE
FCP647	LUCAS/TRW
FCP441	ATE
FCP72	BENDIX

FCP409	LUCAS/TRW
--------	-----------

For material availability see page 16-18 / Per la disponibilità materiali vedere a pagina 16-18

ALFA ROMEO



KW



...ALFA ROMEO

...33

					NOTE			NOTE
1.3	63	05/83 → 07/89	FCP546	ATE		FCP409	LUCAS/TRW	
1.3	63	08/89 → 12/94	FCP647	LUCAS/TRW				
1.3	63	08/89 → 12/94	FCP546	ATE				
1.4	65	08/89 → 12/94	FCP546	ATE				
1.4	65	08/89 → 12/94	FCP647	LUCAS/TRW				
1.5	72	08/89 → 12/94	FCP546	ATE				
1.5	72	08/89 → 12/94	FCP647	LUCAS/TRW	ABS			
1.5	72	08/89 → 12/94				FCP409	LUCAS/TRW	ABS
1.5	62	05/83 → 07/89	FCP441	ATE				
1.5	62	05/83 → 07/89	FCP72	BENDIX				
1.5	62	05/83 → 07/89				FCP409	LUCAS/TRW	
1.5	70	05/83 → 07/89	FCP441	ATE				
1.5	70	05/83 → 07/89	FCP72	BENDIX				
1.5	70	05/83 → 07/89				FCP409	LUCAS/TRW	
1.5	77	05/83 → 07/89	FCP441	ATE				
1.5	77	05/83 → 07/89	FCP72	BENDIX				
1.5	77	05/83 → 07/89				FCP409	LUCAS/TRW	
1.7	84	01/86 → 08/90	FCP546	ATE				
1.7	84	01/86 → 08/90				FCP596	LUCAS/TRW	ABS
1.7	79	08/90 → 12/94	FCP546	ATE				
1.7	79	08/90 → 12/94	FCP647	LUCAS/TRW				
1.7	79	08/90 → 12/94				FCP409	LUCAS/TRW	ABS
1.7 4x4	77	01/86 → 12/89	FCP546	ATE				
1.7 4x4	79	08/90 → 12/94	FCP546	ATE				
1.7 4x4	79	08/90 → 12/94	FCP647	LUCAS/TRW				
1.7 4x4	79	08/90 → 12/94				FCP409	LUCAS/TRW	ABS
1.7 4x4 16V	97	08/90 → 12/94	FCP546	ATE				
1.7 4x4 16V	97	08/90 → 12/94	FCP647	LUCAS/TRW				
1.7 4x4 16V	97	08/90 → 12/94				FCP409	LUCAS/TRW	ABS
1.7 Boxer 16V	79, 97	08/90 → 12/94	FCP546	ATE				
1.7 Boxer 16V	79, 97	08/90 → 12/94	FCP647	LUCAS/TRW				
1.7 Boxer 16V	79, 97	08/90 → 12/94				FCP409	LUCAS/TRW	
1.8 TD	53	01/86 → 07/90	FCP441	ATE				
1.8 TD	62	08/90 → 12/94	FCP546	ATE				
1.8 TD	62	08/90 → 12/94	FCP647	LUCAS/TRW				
1.8 TD	62	08/90 → 12/94				FCP409	LUCAS/TRW	ABS

4C (960)

1.8 TBi	177	03/13 →	FCP1667	BREMBO				
1.8 TBi	177	03/13 →				FCP1795	LUCAS/TRW	

6

2.5	110, 116	01/79 → 12/87				FCP2	ATE	
-----	----------	---------------	--	--	--	------	-----	--

75

1.6	81	09/90 → 12/92	FCP2	ATE				
1.6	81	09/90 → 12/92				FCP93	ATE	
1.6	81	05/85 → 09/90	FCP2	ATE				
1.6	81	05/85 → 09/90				FCP3	ATE	
1.8	88	09/90 → 12/92	FCP2	ATE				
1.8	88	09/90 → 12/92				FCP93	ATE	
1.8	88	05/85 → 09/90	FCP2	ATE				
1.8	88	05/85 → 09/90				FCP3	ATE	
1.8 (Turbo)	114	10/90 → 12/92	FCP448	ATE				
1.8 (Turbo)	114	10/90 → 12/92				FCP93	ATE	
1.8 (Turbo)	110	09/86 → 08/89	FCP448	ATE				
1.8 (Turbo)	110	09/86 → 08/89				FCP3	ATE	
1.8 (Turbo)	114	05/85 → 09/90	FCP448	ATE				
1.8 (Turbo)	114	05/85 → 09/90				FCP3	ATE	
2.0	96	09/90 → 12/92	FCP2	ATE				
2.0	96	09/90 → 12/92				FCP93	ATE	
2.0	96	01/89 → 09/90	FCP2	ATE				
2.0	96	01/89 → 09/90				FCP3	ATE	
2.0 Twin Spark	107	09/90 → 12/92	FCP448	ATE				
2.0 Twin Spark	107	09/90 → 12/92				FCP93	ATE	
2.0 Twin Spark, Veloce	107	05/85 → 09/90	FCP448	ATE				
2.0 Twin Spark, Veloce	107	05/85 → 09/90				FCP3	ATE	
2.4 TD	81	09/90 → 12/92	FCP448	ATE				
2.4 TD	81	09/90 → 12/92				FCP93	ATE	
2.4 TD	81	09/85 → 09/90	FCP448	ATE				
2.4 TD	81	09/85 → 09/90				FCP3	ATE	
2.5	113, 118	09/90 → 12/92	FCP448	ATE				
2.5	113, 118	09/90 → 12/92				FCP93	ATE	
2.5	113, 118	01/89 → 09/90	FCP448	ATE				
2.5	113, 118	01/89 → 09/90				FCP3	ATE	
3.0	136, 138	09/90 → 12/92	FCP448	ATE				
3.0	136, 138	09/90 → 12/92				FCP93	ATE	

For material availability see page 16-18 / Per la disponibilità materiali vedere a pagina 16-18



KW



...ALFA ROMEO

...75

3.0	136, 138	01/89 → 09/90	FCP448	ATE			
3.0	136, 138	01/89 → 09/90			FCP3	ATE	

90

2.5	116	09/84 → 12/87	FCP448	ATE			
2.5	116	09/84 → 12/87			FCP3	ATE	
2.5	116	01/87 → 12/92	FCP448	ATE			
2.5	116	01/87 → 12/92			FCP3	ATE	
3.0		09/87 → 12/92	FCP565	LUCAS/TRW			
3.0		09/87 → 12/92			FCP3	ATE	

Alfasud

1.2	50	01/86 → 12/89	FCP546	ATE			
1.3		01/86 → 12/87	FCP546	ATE			
1.3		01/88 → 12/89	FCP546	ATE			
1.4	57	01/86 → 12/89	FCP546	ATE			
1.5		01/86 → 12/87	FCP546	ATE			
1.5		01/88 → 12/89	FCP546	ATE			

Alfetta

1.6	80	07/72 → 12/78	FCP2	ATE			
1.6	80	07/72 → 12/78			FCP93	ATE	
1.6	80	01/79 → 12/82	FCP2	ATE			
1.6	80	01/79 → 12/82			FCP93	ATE	
1.6	80	01/83 → 12/85	FCP2	ATE			
1.6	80	01/83 → 12/85			FCP3	ATE	
1.8	90	07/72 → 12/78	FCP2	ATE			
1.8	90	07/72 → 12/78			FCP93	ATE	
1.8	90	01/79 → 12/82	FCP2	ATE			
1.8	90	01/79 → 12/82			FCP93	ATE	
1.8	90	01/83 → 12/85	FCP2	ATE			
1.8	90	01/83 → 12/85			FCP3	ATE	
2.0		07/72 → 12/78	FCP2	ATE			
2.0		07/72 → 12/78			FCP93	ATE	
2.0		01/79 → 12/82	FCP2	ATE			
2.0		01/79 → 12/82			FCP93	ATE	
2.0	96	01/83 → 12/85	FCP2	ATE			
2.0	96	01/83 → 12/85			FCP3	ATE	
2.0 TD	60	01/83 → 12/85	FCP2	ATE			
2.0 TD	60	01/80 → 12/83	FCP2	ATE			
2.0 TD	60	01/80 → 12/83			FCP3	ATE	
2.4 TD	81	01/80 → 12/85	FCP2	ATE			
2.4 TD	81	01/80 → 12/85			FCP3	ATE	
2.5 GTV6	116	01/80 → 12/83	FCP116	ATE			
2.5 GTV6	116	01/80 → 12/83			FCP93	ATE	
2.5 GTV6	116	01/84 → 12/87	FCP2	ATE			
2.5 GTV6	116	01/84 → 12/87			FCP3	ATE	

Arna

1.2	46	01/83 → 08/85	FCP441	ATE			
1.2	46	01/83 → 08/85	FCP72	BENDIX			
1.2	46	08/85 → 12/87	FCP441	ATE			
1.3	57	01/83 → 08/85	FCP441	ATE			
1.3	57	01/83 → 08/85	FCP72	BENDIX			
1.3	57	08/85 → 12/87	FCP441	ATE			
1.5	77	01/83 → 08/85	FCP441	ATE			
1.5	77	01/83 → 08/85	FCP72	BENDIX			
1.5	77	08/85 → 12/87	FCP441	ATE			

Brera

1.8 TBi	147	05/09 →	FCP1334	BREMBO			
1.8 TBi	147	05/09 →			FCP1795	LUCAS/TRW	
2.2 2.2 JTS	185	01/06 →	FCP1805	ATE			
2.4 JTDM 20V	147	01/06 →	FCP1334	BREMBO			
2.4 JTDM 20V	147	01/06 →			FCP1795	LUCAS/TRW	
2.4 JTDM 20V	154	05/07 →	FCP1334	BREMBO			
2.4 JTDM 20V	154	05/07 →			FCP1795	LUCAS/TRW	
3.2 JTS	191	03/08 →	FCP1334	BREMBO			
3.2 JTS	191	03/08 →			FCP1795	LUCAS/TRW	
3.2 JTS Q4	191	01/06 →	FCP1334	BREMBO			
3.2 JTS Q4	191	01/06 →			FCP1795	LUCAS/TRW	

For material availability see page 16-18 / Per la disponibilità materiali vedere a pagina 16-18

ALFA ROMEO



KW



...ALFA ROMEO

Giulia

Model	Year	From	To	Part	Supplier	NOTE	Part	Supplier	NOTE
1.3	64	01/66	→ 12/85	FCP2	ATE				
1.3	64	01/66	→ 12/85	FCP2	ATE		FCP3	ATE	
1.6	75	01/66	→ 12/85	FCP2	ATE				
1.6	75	01/66	→ 12/85	FCP2	ATE		FCP3	ATE	
2.0 D		01/76	→ 12/78	FCP2	ATE				
2.0 D		01/76	→ 12/78	FCP2	ATE		FCP3	ATE	

GIULIA (952_)

2.9 (952AAM24)	375	10/15	→	FRP3100	BREMBO				
----------------	-----	-------	---	---------	--------	--	--	--	--

Giulietta

1.3	70	11/77	→ 12/82	FCP2	ATE				
1.3	70	11/77	→ 12/82	FCP2	ATE		FCP93	ATE	
1.3	70	01/83	→ 03/86	FCP2	ATE				
1.3	70	01/83	→ 03/86	FCP2	ATE		FCP3	ATE	
1.6	80	11/77	→ 12/82	FCP2	ATE				
1.6	80	11/77	→ 12/82	FCP2	ATE		FCP93	ATE	
1.6	80	01/83	→ 03/86	FCP2	ATE				
1.6	80	01/83	→ 03/86	FCP2	ATE		FCP3	ATE	
1.8	88	11/77	→ 12/82	FCP2	ATE				
1.8	88	11/77	→ 12/82	FCP2	ATE		FCP93	ATE	
1.8	88	01/83	→ 03/86	FCP2	ATE				
1.8	88	01/83	→ 03/86	FCP2	ATE		FCP3	ATE	
2.0	96	11/77	→ 12/82	FCP2	ATE				
2.0	96	11/77	→ 12/82	FCP2	ATE		FCP93	ATE	
2.0	96	01/83	→ 03/86	FCP2	ATE				
2.0	96	01/83	→ 03/86	FCP2	ATE		FCP3	ATE	
2.0 TD	125	01/83	→ 12/85	FCP2	ATE				
2.0 TD	125	01/83	→ 12/85	FCP2	ATE		FCP3	ATE	

GIULIETTA (940_)

1.4 BiFuel	88	12/11	→	FCP1334	BREMBO	for vehicles with sports package			
1.4 BiFuel	88	12/11	→	FCP1334	BREMBO		FCP4308	LUCAS/TRW	For vehicles without Sport package
1.4 TB	110	09/14	→	FCP1334	BREMBO	For vehicles with Sport package			
1.4 TB	110	09/14	→	FCP1805	ATE	For vehicles without Sport package			
1.4 TB	110	09/14	→	FCP1805	ATE		FCP4308	LUCAS/TRW	For vehicles without Sport package
1.4 TB	120	04/10	→	FCP1805	ATE				
1.4 TB	120	04/10	→	FCP1805	ATE		FCP4308	LUCAS/TRW	For vehicles without Sport package
1.4 TB	125	04/10	→	FCP1805	ATE				
1.4 TB	125	04/10	→	FCP1805	ATE		FCP4308	LUCAS/TRW	For vehicles without Sport package
1.4 TB	77	04/11	→	FCP1805	ATE				
1.4 TB	77	04/11	→	FCP1334	BREMBO	For vehicles with Sport package			
1.4 TB	77	04/11	→	FCP1334	BREMBO		FCP4308	LUCAS/TRW	For vehicles without Sport package
1.4 TB	85	04/10	→	FCP1334	BREMBO	For vehicles with Sport package			
1.4 TB	85	04/10	→	FCP1334	BREMBO		FCP1795	LUCAS/TRW	For vehicles with Sport package
1.4 TB	85	04/10	→	FCP1334	BREMBO		FCP4308	LUCAS/TRW	For vehicles without Sport package
1.4 TB (940FXA1A)	88	04/10	→	FCP1334	BREMBO	For vehicles with Sport package			
1.4 TB (940FXA1A)	88	04/10	→	FCP1334	BREMBO		FCP1795	LUCAS/TRW	For vehicles with Sport package
1.4 TB (940FXA1A)	88	04/10	→	FCP1334	BREMBO		FCP4308	LUCAS/TRW	For vehicles without Sport package
1.6 JTDM (940.FYB1_)	88	02/15	→	FCP1334	BREMBO	For vehicles with Sport package			
1.6 JTDM (940.FYB1_)	88	02/15	→	FCP1334	BREMBO		FCP4308	LUCAS/TRW	For vehicles without Sport package
1.6 JTDM (940.FYE1_)	85	09/15	→	FCP1334	BREMBO	For vehicles with Sport package			
1.6 JTDM (940.FYE1_)	85	09/15	→	FCP1334	BREMBO		FCP4308	LUCAS/TRW	For vehicles without Sport package
1.6 JTDM (940FXD1A)	77	04/10	→	FCP1334	BREMBO	For vehicles with Sport package			
1.6 JTDM (940FXD1A)	77	04/10	→	FCP1334	BREMBO		FCP1795	LUCAS/TRW	For vehicles with Sport package
1.6 JTDM (940FXD1A)	77	04/10	→	FCP1334	BREMBO		FCP4308	LUCAS/TRW	For vehicles without Sport package
1.8 Tbi	173	04/10	→	FCP1334	BREMBO				
2.0 JTDM	100	04/10	→	FCP1334	BREMBO	for vehicles with sports package			
2.0 JTDM	100	04/10	→	FCP1334	BREMBO		FCP4308	LUCAS/TRW	For vehicles without Sport package
2.0 JTDM	103	04/10	→	FCP1805	ATE				
2.0 JTDM	103	04/10	→	FCP1805	ATE		FCP4308	LUCAS/TRW	For vehicles without Sport package
2.0 JTDM	120	04/10	→	FCP1805	ATE				
2.0 JTDM	120	04/10	→	FCP1805	ATE		FCP4308	LUCAS/TRW	For vehicles without Sport package
2.0 JTDM	125	04/10	→	FCP1805	ATE				
2.0 JTDM	125	04/10	→	FCP1805	ATE		FCP4308	LUCAS/TRW	For vehicles without Sport package
2.0 JTDM	129	11/13	→	FCP1334	BREMBO	For vehicles with Sport package			
2.0 JTDM	129	11/13	→	FCP1334	BREMBO		FCP4308	LUCAS/TRW	For vehicles without Sport package
2.0 JTDM (940.FYC1A, 940.FXQ1A)	110	08/13	→	FCP1334	BREMBO	For vehicles with Sport package			
2.0 JTDM (940.FYC1A, 940.FXQ1A)	110	08/13	→	FCP1334	BREMBO		FCP4308	LUCAS/TRW	For vehicles without Sport package

GT

SPRINT 1600		01/63	→ 12/66	FCP11	ATE				
SPRINT 1600		01/63	→ 12/66	FCP11	ATE		FCP3	ATE	

For material availability see page 16-18 / Per la disponibilità materiali vedere a pagina 16-18



KW

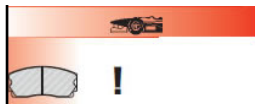

...ALFA ROMEO

GT (937)

Model	Power	Year	Code	Brand	NOTE	Code	Brand	NOTE
1.9 JTD Multijet		01/04 →	FCP1052	ATE				
1.9 JTD Multijet		01/04 →				FCP1349	LUCAS/TRW	
3.2 GTA	176	11/03 →	FCP1334	BREMBO				
3.2 GTA	176	11/03 →				FCP1349	LUCAS/TRW	

GTV

2.0		01/76 → 02/86	FCP2	ATE				
2.0		01/76 → 02/86				FCP93	ATE	
2.0		03/86 → 12/87	FCP2	ATE				
2.0		03/86 → 12/87				FCP3	ATE	
2.0 (Turbo)	147	05/95 →	FCP565	LUCAS/TRW				
2.0 (Turbo)	147	05/95 →	FCP1052	ATE				
2.0 (Turbo)	147	05/95 →				FCP409	LUCAS/TRW	
2.0 16V	110	05/95 →	FCP565	LUCAS/TRW				
2.0 16V	110	05/95 →	FCP1052	ATE				
2.0 16V	110	05/95 →				FCP409	LUCAS/TRW	
2.5	110, 114	10/79 → 12/87	FCP116	ATE				
2.5	110, 114	10/79 → 12/87				FCP93	ATE	
3.0 24V	162	12/96 →	FCP565	LUCAS/TRW				
3.0 24V	162	12/96 →	FCP721	BREMBO				
3.0 24V	162	12/96 →				FCP409	LUCAS/TRW	
3.0 24V	162	12/96 →				FCP1113	LUCAS/TRW	
6 2.5	116	11/80 → 02/87	FCP448	BREMBO				
6 2.5	116	11/80 → 02/87				FCP93	ATE	

MITO (955)

1.4 Turbo MultiAir	99	10/09 → 07/10	FCP1468	BOSCH	until chassis n:1096215			
1.4 Turbo MultiAir	99	10/09 → 07/10				FCP1469	BOSCH	

MiTo(955)

0.9	63	07/11 →	FCP1466	BOSCH				
0.9	63	07/11 →				FCP1349	LUCAS/TRW	
1.3 JTDm	62	01/11 →	FCP1468	BOSCH				
1.3 JTDm	62	01/11 →				FCP1469	BOSCH	
1.3 JTDm	66	09/08 →	FCP1468	BOSCH				
1.3 JTDm	66	09/08 →				FCP1469	BOSCH	
1.3 JTDm	70	09/08 → 07/10	FCP1468	BOSCH	until chassis n:1096215			
1.3 JTDm	70	09/08 → 07/10				FCP1469	BOSCH	
1.4	51	05/11 →	FCP1466	BOSCH				
1.4	51	05/11 →				FCP1349	LUCAS/TRW	
1.4	57	03/11 →	FCP1466	BOSCH				
1.4	57	03/11 →				FCP1349	LUCAS/TRW	
1.4	58	09/08 →	FCP1466	BOSCH				
1.4	58	09/08 →				FCP1469	BOSCH	
1.4	70	09/08 →	FCP1466	BOSCH				
1.4	70	09/08 →				FCP1469	BOSCH	
1.4	77	08/10 →	FCP1466	BOSCH				
1.4	77	08/10 →				FCP1469	BOSCH	
1.4	88	09/08 → 07/10	FCP1468	BOSCH	until chassis n:1096215			
1.4	88	09/08 → 07/10				FCP1469	BOSCH	
1.4 Bifuel	88	07/11 →	FCP1468	BOSCH				
1.4 Bifuel	88	07/11 →				FCP1349	LUCAS/TRW	
1.4 TB	114	09/08 →	FCP1466	BOSCH				
1.4 TB	114	09/08 →	FCP1667	BREMBO				
1.4 TB	114	09/08 →				FCP1469	BOSCH	
1.4 TB	120	10/09 →	FCP1466	BOSCH				
1.4 TB	120	10/09 →	FCP1667	BREMBO				
1.4 TB	120	10/09 →				FCP1469	BOSCH	
1.4 TB	125	10/09 →	FCP1468	BOSCH				
1.4 TB	125	10/09 →	FCP1667	BREMBO				
1.4 TB	125	10/09 →				FCP1469	BOSCH	
1.6 JTDm	85	09/08 →	FCP1468	BOSCH				
1.6 JTDm	85	09/08 →				FCP1469	BOSCH	
1.6 JTDm	88	09/08 →	FCP1468	BOSCH				
1.6 JTDm	88	09/08 →				FCP1469	BOSCH	

Montreal

1.8		01/66 → 12/76	FCP11	ATE				
1.8		01/66 → 12/76				FCP3	ATE	
2.0		01/66 → 12/76	FCP11	ATE				
2.0		01/66 → 12/76				FCP3	ATE	
2.6 16V	148	01/66 → 12/76	FCP11	ATE				
2.6 16V	148	01/66 → 12/76				FCP3	ATE	

For material availability see page 16-18 / Per la disponibilità materiali vedere a pagina 16-18

ALFA ROMEO



KW



...ALFA ROMEO

Spider

				NOTE			NOTE
1.3	01/74 → 12/82	FCP2	ATE				
1.3	01/74 → 12/82				FCP3	ATE	
1.6	75, 76 01/79 → 12/91	FCP2	ATE				
1.6	75, 76 01/79 → 12/91				FCP93	ATE	
1.6	01/74 → 12/78	FCP2	ATE				
1.6	01/74 → 12/78				FCP3	ATE	
2.0	86, 92 08/90 → 12/93	FCP11	ATE				
2.0	86, 92 08/90 → 12/93				FCP3	ATE	
2.0 i	01/83 → 07/90	FCP11	ATE				
2.0 i	01/83 → 07/90				FCP3	ATE	
2.0 i V6 Turbo	148 05/98 →	FCP1052	ATE				
2.0 i V6 Turbo	148 05/98 →				FCP1113	LUCAS/TRW	

SPIDER (916_)

1.8 16V	106 05/98 → 04/05	FCP565	LUCAS/TRW				
1.8 16V	106 05/98 → 04/05	FCP1052	ATE				
1.8 16V	106 05/98 → 04/05	FCP1056	ATE				
1.8 16V	106 05/98 → 04/05				FCP409	LUCAS/TRW	
1.8 16V	106 05/98 → 04/05				FCP1113	LUCAS/TRW	
2.0 T.SPARK 16V	110 06/95 → 04/05	FCP565	LUCAS/TRW				
2.0 T.SPARK 16V	110 06/95 → 04/05	FCP1052	ATE				
2.0 T.SPARK 16V	110 06/95 → 04/05				FCP409	LUCAS/TRW	
2.0 T.SPARK 16V	110 06/95 → 04/05				FCP1113	LUCAS/TRW	
3.0 V6	141 06/95 → 04/05	FCP565	LUCAS/TRW				
3.0 V6	141 06/95 → 04/05	FCP721	BREMBO	sport package			
3.0 V6	141 06/95 → 04/05	FCP1052	ATE				
3.0 V6	141 06/95 → 04/05				FCP409	LUCAS/TRW	
3.0 V6	141 06/95 → 04/05				FCP1113	LUCAS/TRW	

SPIDER (939)

1.8 TBi	147 05/09 →	FCP1334	BREMBO				
1.8 TBi	147 05/09 →				FCP1795	LUCAS/TRW	for vehicles without Sport package
2.4 JTDM	147 04/07 →	FCP1334	BREMBO				
2.4 JTDM	147 04/07 →				FCP1795	LUCAS/TRW	
2.4 JTDM	154 03/08 →	FCP1334	BREMBO				
2.4 JTDM	154 03/08 →				FCP1795	LUCAS/TRW	
3.2 JTS	191 03/08 →	FCP1334	BREMBO				
3.2 JTS	191 03/08 →				FCP1795	LUCAS/TRW	
3.2 JTS Q4	191 09/06 →	FCP1334	BREMBO				
3.2 JTS Q4	191 09/06 →				FCP1795	LUCAS/TRW	

SPIDER (939_)

2.2 JTS	136 03/06 → 03/11	FCP1805	ATE				
2.2 JTS	136 03/06 → 03/11	FCP1334	BREMBO	For TI equipment only			

Sprint

1.7	77, 87 03/87 → 12/89	FCP546	ATE				
-----	----------------------	--------	-----	--	--	--	--

STELVIO (949_)

2.9	375 12/16 →	FRP3100	BREMBO				
-----	-------------	---------	--------	--	--	--	--

SZ

3.0 24V	152, 188 09/89 → 12/96	FCP448	ATE				
3.0 24V	152, 188 09/89 → 12/96				FCP3	ATE	

ALPINA

B10 (E39)

4.6 V8	250 12/96 → 10/98	FCP997	ATE				
4.6 V8	255 10/98 → 08/00	FCP997	ATE				
4.8 V8	276 04/02 →	FCP997	ATE				

B10 Touring (E39)

4.6 V8	250 08/97 → 10/98	FCP997	ATE				
4.6 V8	255 10/98 → 07/00	FCP997	ATE				
4.8 V8	276 04/02 →	FCP997	ATE				

ASIA MOTORS

For material availability see page 16-18 / Per la disponibilità materiali vedere a pagina 16-18



KW



ASIA MOTORS

Rocsta

1.8 i	57	02/92 → 06/98	FCP170	SUMITOMO			
2.2 i	45	02/92 → 12/98	FCP170	SUMITOMO			

ASTON MARTIN

DB5

4.0		01/63 → 12/65	FCP9	LUCAS/TRW			
4.0		01/63 → 12/65			FCP815	LUCAS/TRW	

DB6

5.3		01/66 → 12/71	FCP9	LUCAS/TRW			
5.3		01/66 → 12/71			FCP815	LUCAS/TRW	

DB7

3.2		01/93 → 12/97	FCP817	LUCAS/TRW			
3.2		01/93 → 12/97			FCP815	LUCAS/TRW	
3.2		01/97 →	FCP817	LUCAS/TRW			
3.2		01/97 →			FCP732	ATE	
5.9		01/99 →	FRP3028	BREMBO			
5.9		01/99 →			FRP3109	BREMBO	

DB9

5.9		01/03 →	FRP3067	BREMBO			
5.9		01/03 →			FRP3109	BREMBO	

DBS

5.3 Not V8		01/67 → 12/75	FCP9	LUCAS/TRW			
5.3 Not V8		01/67 → 12/75			FCP815	LUCAS/TRW	
5.3 V8		01/70 → 12/74	FCP9	LUCAS/TRW			
5.3 V8		01/70 → 12/74			FCP815	LUCAS/TRW	

LAGONDA I

5.3	250	01/76 → 12/97	FCP817	LUCAS/TRW			
5.3	250	01/76 → 12/97			FCP815	LUCAS/TRW	

LAGONDA I Estate

5.3	228	01/76 → 12/97	FCP817	LUCAS/TRW			
5.3	228	01/76 → 12/97			FCP815	LUCAS/TRW	

Lagonda Rapide

4.0	258	01/61 → 12/65			FCP815	LUCAS/TRW	
4.0	260	01/61 → 12/65			FCP815	LUCAS/TRW	
4.0	262	01/61 → 12/65			FCP815	LUCAS/TRW	

V8

5.3		01/73 →			FCP815	BREMBO	
-----	--	---------	--	--	--------	--------	--

Vanquish

5.9 (AP Caliper)		01/01 → 12/04	FRP3084	AP RACING			
5.9 (Brembo Caliper)		01/01 → 12/04	FRP3028	BREMBO			
5.9 (Brembo Caliper)		01/01 → 12/04			FRP3109	BREMBO	

Vanquish S

5.9		01/04 →	FRP3084	AP RACING			
-----	--	---------	---------	-----------	--	--	--

Vantage

4.3	283	01/04 → 12/08	FRP3067	BREMBO			
4.3	283	01/04 → 12/08			FRP3109	BREMBO	
4.7	313	01/08 →	FRP3067	BREMBO			
4.7	313	01/08 →			FRP3109	BREMBO	
5.3 (Solid rear disc)		01/93 → 12/97	FRP216	BREMBO			
5.3 (Solid rear disc)		01/93 → 12/97	FRP217	BREMBO			
5.3 (Vented rear disc)		01/93 → 12/97	FRP217	BREMBO			
5.3 (Vented rear disc)		01/93 → 12/97	FRP216	BREMBO			
5.3 i V8		01/96 → 12/97	FCP1224	LUCAS/TRW			
5.3 i V8		01/96 → 12/97			FCP815	LUCAS/TRW	
5.3 i V8 Volante	262	01/87 → 12/93			FCP815	LUCAS/TRW	
5.3 i V8 Volante	262	08/93 →	FCP9	LUCAS/TRW			
5.3 i V8 Volante	262	08/93 →			FCP815	LUCAS/TRW	

For material availability see page 16-18 / Per la disponibilità materiali vedere a pagina 16-18

1010

FERODO

RACING

Updated on 17th Aug 2018



KW



...ASTON MARTIN

Vantage Coupe

4.3	283	10/05 → 12/08	FRP3067	BREMBO
4.3	283	10/05 → 12/08		
4.7	313	01/08 →	FRP3067	BREMBO
4.7	313	01/08 →		

Virage

5.3 32V	242	01/89 → 12/93	FCP817	LUCAS/TRW
5.3 32V	242	01/89 → 12/93		
5.3 32V (Solid rear disc)	242	01/93 →	FRP216	BREMBO

Virage Contd.

5.3	242	01/96 →	FCP1224	LUCAS/TRW
5.3 (Solid rear disc)	242	01/93 →	FRP217	BREMBO
5.3 (Vented rear disc)	242	01/93 →	FRP216	BREMBO
5.3 (Vented rear disc)	242	01/93 →	FRP217	BREMBO

Volante

5.3		01/76 → 12/93		
5.3		01/93 →	FRP216	BREMBO
5.3		01/94 →	FRP217	BREMBO
5.3		01/96 →	FCP1224	LUCAS/TRW

Zagato

5.3		01/85 → 12/88		
-----	--	---------------	--	--

AUDI

100

1.6	63	08/81 → 09/82	FCP370	LUCAS/TRW
1.8	66	09/82 → 09/88	FCP775	LUCAS/TRW
1.8	66	10/88 → 12/90	FCP775	LUCAS/TRW
1.8 100 Quattro	66	01/84 → 08/86	FCP775	LUCAS/TRW
1.8 100 Quattro	66	01/84 → 08/86		
1.8 100 Quattro Avant	66	01/85 → 08/88	FCP775	LUCAS/TRW
1.8 100 Quattro Avant	66	01/85 → 08/88		
1.8 Avant	66	01/76 → 12/82	FCP775	LUCAS/TRW
1.8 Avant	66	01/82 → 01/85	FCP775	LUCAS/TRW
1.8 Avant	66	01/82 → 01/85		
1.9	74	09/81 → 07/82	FCP370	LUCAS/TRW
1.9	74	09/82 → 12/90	FCP775	LUCAS/TRW
1.9	74	09/82 → 12/90		
1.9 Avant	74	01/76 → 12/82	FCP775	LUCAS/TRW
1.9 Avant	74	01/82 → 01/85	FCP775	LUCAS/TRW
1.9 Avant	74	01/82 → 01/85		
2.0	51, 66	09/82 → 09/88	FCP775	LUCAS/TRW
2.0	51, 66	09/82 → 09/88		
2.0	51, 66	10/88 → 12/90	FCP775	LUCAS/TRW
2.0	51, 66	10/88 → 12/90		
2.0	74	12/90 → 06/94	FCP590	ATE
2.0	74	12/90 → 06/94		
2.0 100 Quattro	85, 98	12/90 → 12/94	FCP590	ATE
2.0 100 Quattro	85, 98	12/90 → 12/94		
2.0 100 Quattro Avant	85, 103	12/90 → 12/94	FCP590	ATE
2.0 100 Quattro Avant	85, 103	12/90 → 12/94		
2.0 100 Quattro E 16V	103	01/93 → 12/94	FCP590	ATE
2.0 100 Quattro E 16V	103	01/93 → 12/94		
2.0 Avant	51	01/76 → 12/82	FCP775	LUCAS/TRW
2.0 Avant	51	01/82 → 01/85	FCP775	LUCAS/TRW
2.0 Avant	51	01/82 → 01/85		
2.0 Avant E	85	01/85 → 11/90	FCP775	LUCAS/TRW
2.0 Avant E	85	01/85 → 11/90		
2.0 Avant Not S4	85	01/91 → 12/94	FCP590	ATE
2.0 Avant Not S4	85	01/91 → 12/94		
2.0 D	51	08/78 → 07/82	FCP370	LUCAS/TRW
2.0 D	51	08/82 → 07/84	FCP775	LUCAS/TRW
2.0 D	51	08/82 → 07/84		
2.0 D	51	08/84 → 07/88	FCP775	LUCAS/TRW
2.0 D	51	08/84 → 07/88		
2.0 D Avant	51	08/78 → 02/83	FCP370	LUCAS/TRW
2.0 D Avant	51	03/83 → 08/88	FCP775	LUCAS/TRW
2.0 D Avant	51	03/83 → 08/88		
2.0 D Avant	51	09/88 → 11/90	FCP775	LUCAS/TRW
2.0 D Avant	51	09/88 → 11/90		
2.0 TD	51, 66	08/82 → 07/84	FCP775	LUCAS/TRW
2.0 TD	51, 66	08/82 → 07/84		

NOTE

NOTE

FRP3109	BREMBO
FRP3109	BREMBO

FCP815	LUCAS/TRW
--------	-----------

FCP815	LUCAS/TRW
--------	-----------

FCP815	BREMBO
--------	--------

AUDI

For material availability see page 16-18 / Per la disponibilità materiali vedere a pagina 16-18



KW



...AUDI

...100

					NOTE			NOTE
2.0 TD	51, 66	08/84 → 11/90	FCP775	LUCAS/TRW				
2.0 TD	51, 66	08/84 → 11/90				FCP596	LUCAS/TRW	
2.1	95, 96	09/82 → 12/90	FCP775	LUCAS/TRW				
2.1	95, 96	09/82 → 12/90				FCP596	LUCAS/TRW	
2.1 Avant	95	01/76 → 12/82	FCP775	LUCAS/TRW				
2.1 Avant	95, 96	01/82 → 01/85	FCP775	LUCAS/TRW				
2.1 Avant	95, 96	01/82 → 01/85				FCP596	LUCAS/TRW	
2.1 E 10V	85, 95	07/80 → 09/82	FCP775	LUCAS/TRW				
2.1 S	85	01/78 → 09/82	FCP370	LUCAS/TRW				
2.2	100	09/80 → 07/82	FCP775	LUCAS/TRW				
2.2	85	10/77 → 08/78	FCP370	LUCAS/TRW				
2.2	85	09/78 → 07/82	FCP370	LUCAS/TRW				
2.2 100 Quattro	101	01/84 → 08/86	FCP775	LUCAS/TRW				
2.2 100 Quattro	101	01/84 → 08/86				FCP596	LUCAS/TRW	
2.2 100 Quattro 20V	169	12/90 → 12/94	FCP590	ATE				
2.2 100 Quattro 20V	169	12/90 → 12/94				FCP596	LUCAS/TRW	
2.2 100 Quattro Avant	101	01/84 → 08/86	FCP775	LUCAS/TRW				
2.2 100 Quattro Avant	101	01/84 → 08/86				FCP596	LUCAS/TRW	
2.2 Avant	100	01/76 → 12/82	FCP775	LUCAS/TRW				
2.2 Avant	85	01/76 → 12/82	FCP775	LUCAS/TRW				
2.2 S4 + SW Estate	169	12/90 → 12/94	FCP590	ATE				
2.2 S4 + SW Estate	169	12/90 → 12/94				FCP596	LUCAS/TRW	
2.3 100 Quattro	98, 100	12/90 → 12/94	FCP590	ATE				
2.3 100 Quattro	98, 100	12/90 → 12/94				FCP596	LUCAS/TRW	
2.3 100 Quattro Avant	100	01/85 → 08/88	FCP775	LUCAS/TRW				
2.3 100 Quattro Avant	100	01/85 → 08/88				FCP596	LUCAS/TRW	
2.3 100 Quattro Avant	98, 100	12/90 → 12/94	FCP590	ATE				
2.3 100 Quattro Avant	98, 100	12/90 → 12/94				FCP596	LUCAS/TRW	
2.3 10V	100	09/82 → 09/88	FCP775	LUCAS/TRW				
2.3 10V	100	09/82 → 09/88				FCP596	LUCAS/TRW	
2.3 10V	100	10/88 → 12/90	FCP775	LUCAS/TRW				
2.3 10V	100	10/88 → 12/90				FCP596	LUCAS/TRW	
2.3 Avant		01/76 → 12/82	FCP775	LUCAS/TRW				
2.3 Avant	98	01/91 → 12/94	FCP590	ATE				
2.3 Avant	98	01/91 → 12/94				FCP596	LUCAS/TRW	
2.3 E	98	12/90 → 12/94	FCP590	ATE				
2.3 E	98	12/90 → 12/94				FCP596	LUCAS/TRW	
2.4 D	60	08/89 → 07/91	FCP775	LUCAS/TRW				
2.4 D	60	08/89 → 07/91				FCP596	LUCAS/TRW	
2.4 D	60	08/91 → 12/94	FCP590	ATE				
2.4 D	60	08/91 → 12/94				FCP596	LUCAS/TRW	
2.4 D Avant	60	01/76 → 12/82	FCP775	LUCAS/TRW				
2.4 D Avant	60	01/91 → 12/94	FCP590	ATE				
2.4 D Avant	60	01/91 → 12/94				FCP596	LUCAS/TRW	
2.5 TD	60	12/90 → 12/94	FCP590	ATE				
2.5 TD	60	12/90 → 12/94				FCP596	LUCAS/TRW	
2.5 TD 10V	88	09/82 → 12/90	FCP775	LUCAS/TRW				
2.5 TD 10V	88	09/82 → 12/90				FCP596	LUCAS/TRW	
2.5 TD Avant	85	01/76 → 12/82	FCP775	LUCAS/TRW				
2.5 TD Avant	85	01/91 → 12/94	FCP590	ATE				
2.5 TD Avant	85	01/91 → 12/94				FCP596	LUCAS/TRW	
2.5 TDi	85	12/90 → 12/94	FCP590	ATE				
2.5 TDi	85	12/90 → 12/94				FCP596	LUCAS/TRW	
2.5 TDi	88	01/90 → 11/90	FCP775	LUCAS/TRW				
2.5 TDi	88	01/90 → 11/90				FCP596	LUCAS/TRW	
2.6 100 Quattro Avant	110	12/90 → 12/94	FCP590	ATE				
2.6 100 Quattro Avant	110	12/90 → 12/94				FCP596	LUCAS/TRW	
2.6 E	110	12/90 → 12/94	FCP590	ATE				
2.6 E	110	12/90 → 12/94				FCP596	LUCAS/TRW	
2.8 100 Quattro Avant	128	12/90 → 12/94	FCP590	ATE				
2.8 100 Quattro Avant	128	12/90 → 12/94				FCP596	LUCAS/TRW	
2.8 E	128	12/90 → 12/94	FCP590	ATE				
2.8 E	128	12/90 → 12/94				FCP596	LUCAS/TRW	
4.2 100 Quattro 32V	206	12/90 → 12/94	FCP590	ATE				
4.2 100 Quattro 32V	206	12/90 → 12/94				FCP596	LUCAS/TRW	
100 (44, 44Q, C3)								
2.2	101	08/84 → 12/88	FCP775	LUCAS/TRW				
2.2	101	08/84 → 12/88				FCP596	LUCAS/TRW	
2.2	85	10/84 → 09/86	FCP775	LUCAS/TRW				
2.2	85	10/84 → 09/86				FCP596	LUCAS/TRW	
2.2 Cat	101	06/89 → 11/90	FCP775	LUCAS/TRW				
2.2 Cat	101	06/89 → 11/90				FCP596	LUCAS/TRW	
2.2 Turbo	121	08/86 → 11/90	FCP775	LUCAS/TRW				
2.2 Turbo	121	08/86 → 11/90				FCP596	LUCAS/TRW	

For material availability see page 16-18 / Per la disponibilità materiali vedere a pagina 16-18

1012

FERODO

RACING

Updated on 17th Aug 2018



KW



...AUDI

100 (C1)

1.6	63	01/75 → 07/76
1.8	59	11/68 → 11/71
1.8	63	09/71 → 07/74
1.8	74	10/70 → 07/76
1.9	82	09/71 → 07/76

FCP105	ATE
FCP105	ATE
FCP105	ATE
FCP105	ATE
FCP105	ATE

NOTE

NOTE

100 Avant (44, 44Q, C3)

2.2	101	08/84 → 12/88
2.2	101	08/84 → 12/88
2.2	85	10/84 → 09/86
2.2	85	10/84 → 09/86
2.2 Cat quattro	101	06/89 → 11/90
2.2 Cat quattro	101	06/89 → 11/90
2.2 E quattro	88	08/85 → 07/86
2.2 E quattro	88	08/85 → 07/86
2.2 quattro	101	08/84 → 12/88
2.2 quattro	101	08/84 → 12/88
2.2 Turbo quattro	121	08/86 → 11/90
2.2 Turbo quattro	121	08/86 → 11/90

FCP775	LUCAS/TRW
FCP596	LUCAS/TRW
FCP775	LUCAS/TRW
FCP775	LUCAS/TRW
FCP775	LUCAS/TRW
FCP775	LUCAS/TRW
FCP775	LUCAS/TRW
FCP775	LUCAS/TRW
FCP775	LUCAS/TRW
FCP775	LUCAS/TRW
FCP775	LUCAS/TRW
FCP775	LUCAS/TRW

FCP596	LUCAS/TRW
FCP596	LUCAS/TRW
FCP596	LUCAS/TRW
FCP596	LUCAS/TRW
FCP596	LUCAS/TRW
FCP596	LUCAS/TRW
FCP596	LUCAS/TRW
FCP596	LUCAS/TRW
FCP596	LUCAS/TRW
FCP596	LUCAS/TRW
FCP596	LUCAS/TRW

100 Avant (4A5, C4)

S4 Turbo quattro	169	09/91 → 07/94
S4 Turbo quattro	169	09/91 → 07/94

FCP590	ATE
FCP596	LUCAS/TRW

200

2.0		09/83 → 11/90
2.0		09/83 → 11/90
2.0 TD	55	09/83 → 11/90
2.0 TD	55	09/83 → 11/90
2.1	100, 125	01/79 → 07/83
2.1	100, 125	01/79 → 07/83
2.2	100	10/79 → 09/82
2.2	100	10/79 → 09/82
2.2	103	07/83 → 01/86
2.2	103	07/83 → 01/86
2.3	100	07/83 → 01/86
2.3	100	07/83 → 01/86

FCP775	LUCAS/TRW
FCP775	LUCAS/TRW
FCP775	LUCAS/TRW
FCP775	LUCAS/TRW
FCP775	LUCAS/TRW
FCP775	LUCAS/TRW
FCP775	LUCAS/TRW
FCP775	LUCAS/TRW
FCP775	LUCAS/TRW
FCP775	LUCAS/TRW
FCP775	LUCAS/TRW
FCP775	LUCAS/TRW

FCP596	LUCAS/TRW
FCP596	LUCAS/TRW
FCP596	LUCAS/TRW
FCP596	LUCAS/TRW
FCP596	LUCAS/TRW
FCP596	LUCAS/TRW
FCP596	LUCAS/TRW
FCP596	LUCAS/TRW
FCP596	LUCAS/TRW
FCP596	LUCAS/TRW
FCP596	LUCAS/TRW
FCP596	LUCAS/TRW

200 (44, 44Q)

2.1 5E	100	08/83 → 07/84
2.1 5E	100	08/83 → 07/84
2.1 Turbo	134	08/83 → 01/88
2.1 Turbo	134	08/83 → 01/88
2.1 Turbo quattro	134	08/83 → 09/86
2.1 Turbo quattro	134	08/83 → 09/86

FCP775	LUCAS/TRW
FCP596	LUCAS/TRW
FCP775	LUCAS/TRW
FCP775	LUCAS/TRW
FCP775	LUCAS/TRW
FCP775	LUCAS/TRW

FCP596	LUCAS/TRW
FCP596	LUCAS/TRW
FCP596	LUCAS/TRW
FCP596	LUCAS/TRW
FCP596	LUCAS/TRW
FCP596	LUCAS/TRW

200 Avant (44, 44Q)

2.1 Turbo quattro	134	09/83 → 01/88
2.1 Turbo quattro	134	09/83 → 01/88

FCP775	LUCAS/TRW
FCP596	LUCAS/TRW

50

1.1	37	01/74 → 12/80
1.1	38	01/74 → 12/80
1.1	44	01/74 → 12/80
1.3	44	01/74 → 12/80

FCP105	ATE
FCP105	ATE
FCP105	ATE
FCP105	ATE

60

1.4	40	09/68 → 08/72
-----	----	---------------

FCP105	ATE
--------	-----

80

1.3	40, 44	12/74 → 09/79
1.3	44	10/79 → 08/86
1.3	44	10/79 → 08/86
1.3 Auto	40, 44	01/72 → 11/74
1.3 Manual	40, 44	01/72 → 11/74
1.3 Variant	40, 44	01/66 → 12/72
1.4		09/86 → 06/91
1.5 Auto	55	01/72 → 11/74
1.5 Auto	55	12/74 → 07/76
1.5 Auto	55	08/76 → 07/81
1.5 Manual	55	01/72 → 11/74
1.5 Manual	55	12/74 → 07/76
1.5 Manual	55	08/76 → 07/81
1.5 Variant	55	01/66 → 12/72
1.6	52, 75	07/91 → 01/96
1.6	52, 75	07/91 → 01/96

FCP105	ATE
FCP370	LUCAS/TRW
FCP774	LUCAS/TRW
FCP105	ATE
FCP105	ATE
FCP2	ATE
FCP775	LUCAS/TRW
FCP105	ATE
FCP105	ATE
FCP105	ATE
FCP105	ATE
FCP105	ATE
FCP105	ATE
FCP105	ATE
FCP2	ATE
FCP775	LUCAS/TRW

Solid
Vented

FCP596	LUCAS/TRW
FCP596	LUCAS/TRW
FCP596	LUCAS/TRW
FCP596	LUCAS/TRW
FCP596	LUCAS/TRW
FCP596	LUCAS/TRW
FCP596	LUCAS/TRW
FCP596	LUCAS/TRW
FCP596	LUCAS/TRW
FCP596	LUCAS/TRW
FCP596	LUCAS/TRW
FCP596	LUCAS/TRW
FCP596	LUCAS/TRW
FCP596	LUCAS/TRW
FCP596	LUCAS/TRW
FCP596	LUCAS/TRW

For material availability see page 16-18 / Per la disponibilità materiali vedere a pagina 16-18



KW



...AUDI

...80

					NOTE			NOTE
1.6	51	10/79 → 08/86	FCP370	LUCAS/TRW	Solid			
1.6	53	10/79 → 08/86	FCP370	LUCAS/TRW	Solid			
1.6	55	10/79 → 08/86	FCP370	LUCAS/TRW	Solid			
1.6 Auto		01/72 → 11/74	FCP105	ATE				
1.6 Auto		12/74 → 09/79	FCP105	ATE				
1.6 Manual		01/72 → 11/74	FCP105	ATE				
1.6 Manual		12/74 → 09/79	FCP105	ATE				
1.6 Variant		01/66 → 12/72	FCP2	ATE				
1.8	65	10/79 → 08/86	FCP370	LUCAS/TRW	Solid			
1.8	66	10/79 → 08/86	FCP370	LUCAS/TRW	Solid			
1.8	68	10/79 → 08/86	FCP370	LUCAS/TRW	Solid			
1.8 80 Quattro	66	01/83 → 09/86	FCP774	LUCAS/TRW				
1.8 80 Quattro	66	01/83 → 09/86				FCP596	LUCAS/TRW	
1.8 80 Quattro	66	09/86 → 08/88	FCP775	LUCAS/TRW				
1.8 80 Quattro	66	09/86 → 08/88				FCP596	LUCAS/TRW	
1.8 80 Quattro	68	01/83 → 09/86	FCP774	LUCAS/TRW				
1.8 80 Quattro	68	01/83 → 09/86				FCP596	LUCAS/TRW	
1.8 80 Quattro	82	01/83 → 09/86	FCP774	LUCAS/TRW				
1.8 80 Quattro	82	01/83 → 09/86				FCP596	LUCAS/TRW	
1.8 Std, S	83	09/86 → 06/91	FCP775	LUCAS/TRW				
1.9	85	10/79 → 08/86	FCP370	LUCAS/TRW	Solid			
1.9	85	10/79 → 08/86	FCP774	LUCAS/TRW	Vented			
1.9 80 Quattro	83	09/86 → 08/88	FCP775	LUCAS/TRW				
1.9 80 Quattro	83	09/86 → 08/88				FCP596	LUCAS/TRW	
1.9 Automatic	85	08/81 → 07/83	FCP370	LUCAS/TRW	Solid			
1.9 D	48	09/86 → 06/91	FCP775	LUCAS/TRW				
1.9 D	48	07/91 → 09/95	FCP775	LUCAS/TRW				
1.9 E	83	09/86 → 06/91	FCP775	LUCAS/TRW				
1.9 E	83	09/86 → 06/91				FCP596	LUCAS/TRW	
1.9 TD		07/91 → 08/92	FCP775	LUCAS/TRW				
1.9 TD		07/91 → 08/92				FCP596	LUCAS/TRW	
1.9 TD		09/92 → 12/94	FCP775	LUCAS/TRW				
1.9 TD		09/92 → 12/94				FCP596	LUCAS/TRW	
1.9 TDi	66	07/92 → 01/96	FCP775	LUCAS/TRW				
1.9 TDi	66	07/92 → 01/96				FCP596	LUCAS/TRW	
1.9 TDi	66	07/92 → 01/96				FCP409	LUCAS/TRW	
2.0	85	10/79 → 08/86	FCP370	LUCAS/TRW	Solid			
2.0	85	10/79 → 08/86	FCP774	LUCAS/TRW	Vented			
2.0 80 Quattro	82, 85	06/91 → 07/92	FCP775	LUCAS/TRW				
2.0 80 Quattro	82, 85	06/91 → 07/92				FCP596	LUCAS/TRW	
2.0 80 Quattro	82, 85	08/92 → 12/96	FCP775	LUCAS/TRW				
2.0 80 Quattro	82, 85	08/92 → 12/96				FCP596	LUCAS/TRW	
2.0 80 Quattro	85	08/82 → 12/84	FCP774	LUCAS/TRW				
2.0 80 Quattro	85	08/82 → 12/84				FCP596	LUCAS/TRW	
2.0 80 Quattro	85	01/85 → 09/86	FCP774	LUCAS/TRW				
2.0 80 Quattro	85	01/85 → 09/86				FCP596	LUCAS/TRW	
2.0 Automatic	85	09/83 →	FCP370	LUCAS/TRW	Solid			
2.0 Avant	106	07/92 → 01/96	FCP775	LUCAS/TRW				
2.0 Avant	106	07/92 → 01/96				FCP596	LUCAS/TRW	
2.0 E 16V	103	07/91 → 12/94	FCP775	LUCAS/TRW				
2.0 E 16V	103	07/91 → 12/94				FCP596	LUCAS/TRW	
2.0 Not Sport 16V	101	09/86 → 06/91	FCP775	LUCAS/TRW				
2.0 Not Sport 16V	101	09/86 → 06/91				FCP596	LUCAS/TRW	
2.1	85	10/79 → 08/86	FCP370	LUCAS/TRW	Solid			
2.1	85	10/79 → 08/86	FCP774	LUCAS/TRW	Vented			
2.1 80 Quattro	96, 100	01/83 → 09/86	FCP775	LUCAS/TRW				
2.1 80 Quattro	96, 100	01/83 → 09/86				FCP596	LUCAS/TRW	
2.2 80 Quattro 20V	169	01/83 → 05/87	FCP774	LUCAS/TRW				
2.2 80 Quattro 20V	169	01/83 → 05/87				FCP596	LUCAS/TRW	
2.2 80 Quattro Avant RS2 Turbo 20V	232	03/94 → 05/95	FCP560	ATE				
2.2 80 Quattro Avant RS2 Turbo 20V	232	03/94 → 05/95				FCP541	LUCAS/TRW	
2.2 80 Quattro Saloon 20V	169	06/91 → 07/96	FCP775	LUCAS/TRW				
2.2 80 Quattro Saloon 20V	169	06/91 → 07/96				FCP596	LUCAS/TRW	
2.2 E		09/86 → 06/91	FCP775	LUCAS/TRW				
2.2 E		09/86 → 06/91				FCP596	LUCAS/TRW	
2.3 80 Quattro Saloon	98	06/91 → 07/92	FCP775	LUCAS/TRW				
2.3 80 Quattro Saloon	98	06/91 → 07/92				FCP596	LUCAS/TRW	
2.3 E	98	07/91 → 07/92	FCP775	LUCAS/TRW				
2.3 E	98	07/91 → 07/92				FCP596	LUCAS/TRW	
2.3 E	98	08/92 → 12/96	FCP775	LUCAS/TRW				
2.3 E	98	08/92 → 12/96				FCP596	LUCAS/TRW	
2.3 i E		09/86 → 06/91	FCP775	LUCAS/TRW				
2.6	110	07/92 → 12/96	FCP775	LUCAS/TRW				
2.6	110	07/92 → 12/96				FCP596	LUCAS/TRW	
2.6 80 Quattro Saloon	110	06/91 → 07/96	FCP775	LUCAS/TRW				
2.6 80 Quattro Saloon	110	06/91 → 07/96				FCP596	LUCAS/TRW	
2.6 80 Quattro V6 Avant	110	07/92 → 12/96	FCP775	LUCAS/TRW				
2.6 80 Quattro V6 Avant	110	07/92 → 12/96				FCP596	LUCAS/TRW	

For material availability see page 16-18 / Per la disponibilità materiali vedere a pagina 16-18



KW



...AUDI

...80

			NOTE			NOTE		
2.8 80 Quattro Saloon	128	06/91 → 12/94	FCP775	LUCAS/TRW				
2.8 80 Quattro Saloon	128	06/91 → 12/94			FCP596	LUCAS/TRW		
80 (89, 89Q, 8A, B3)								
1.6	51	08/87 → 09/91	FCP775	LUCAS/TRW				
1.6	55	09/86 → 08/91	FCP775	LUCAS/TRW				
1.6 D	40	02/87 → 07/89	FCP775	LUCAS/TRW				
1.6 TD	59	09/86 → 08/91	FCP775	LUCAS/TRW				
1.8	55	10/86 → 01/90	FCP775	LUCAS/TRW				
1.8	55	10/86 → 01/90			FCP596	LUCAS/TRW		
1.8 E	82	06/86 → 08/91	FCP775	LUCAS/TRW				
1.8 E	82	06/86 → 08/91			FCP596	LUCAS/TRW		
1.8 S	66	09/86 → 10/91	FCP775	LUCAS/TRW				
1.8 S	66	09/86 → 10/91			FCP596	LUCAS/TRW		

90

1.4		09/86 → 06/91	FCP775	LUCAS/TRW				
1.6 TD	51	01/84 → 07/87	FCP774	LUCAS/TRW				
1.6 TD	59	07/87 → 12/92	FCP775	LUCAS/TRW				
1.8	82	01/84 → 07/87	FCP774	LUCAS/TRW				
1.8	82	08/89 → 12/92	FCP775	LUCAS/TRW				
1.9 TD		09/86 → 06/91	FCP775	LUCAS/TRW				
2.0	85	01/84 → 07/87	FCP774	LUCAS/TRW				
2.0	85	07/87 → 12/92	FCP774	LUCAS/TRW				
2.0	85	07/87 → 12/92	FCP775	LUCAS/TRW				
2.0	85	07/87 → 12/92			FCP596	LUCAS/TRW		
2.0 90 Quattro	100	07/87 → 12/92	FCP775	LUCAS/TRW				
2.0 90 Quattro	100	07/87 → 12/92			FCP596	LUCAS/TRW		
2.0 90 Quattro	85	01/85 → 07/87	FCP774	LUCAS/TRW				
2.0 90 Quattro	85	01/85 → 07/87			FCP596	LUCAS/TRW		
2.2	100	07/87 → 12/92	FCP774	LUCAS/TRW				
2.2	100	07/87 → 12/92	FCP775	LUCAS/TRW				
2.2	100	07/87 → 12/92			FCP596	LUCAS/TRW		
2.2	89, 100	01/84 → 07/87	FCP774	LUCAS/TRW				
2.2	89, 100	01/84 → 07/87			FCP596	LUCAS/TRW		
2.2 90 Quattro	100	07/87 → 12/92	FCP775	LUCAS/TRW				
2.2 90 Quattro	100	07/87 → 12/92			FCP596	LUCAS/TRW		
2.2 90 Quattro	89, 100	01/85 → 07/87	FCP774	LUCAS/TRW				
2.2 90 Quattro	89, 100	01/85 → 07/87			FCP596	LUCAS/TRW		
2.3	98, 100	07/87 → 12/92	FCP774	LUCAS/TRW				
2.3	98, 100	07/87 → 12/92	FCP775	LUCAS/TRW				
2.3	98, 100	07/87 → 12/92			FCP596	LUCAS/TRW		
2.3 90 Quattro	98	01/85 → 07/87	FCP774	LUCAS/TRW				
2.3 90 Quattro	98	01/85 → 07/87			FCP596	LUCAS/TRW		
2.3 90 Quattro	98	07/87 → 12/92	FCP775	LUCAS/TRW				
2.3 90 Quattro	98	07/87 → 12/92			FCP596	LUCAS/TRW		
2.3 90 Quattro E	125	04/87 → 07/88	FCP775	LUCAS/TRW				
2.3 90 Quattro E	125	04/87 → 07/88			FCP596	LUCAS/TRW		
2.3 90 Quattro E 20V	125	08/88 → 07/91	FCP775	LUCAS/TRW				
2.3 E	100	04/87 → 07/88	FCP775	LUCAS/TRW				
2.3 E	100	04/87 → 07/88			FCP596	LUCAS/TRW		
2.3 E	98	03/90 → 07/91	FCP775	LUCAS/TRW				
2.3 E	98	03/90 → 07/91			FCP596	LUCAS/TRW		

A1 (8X1)

1.2 TFSI	63	05/10 →	FCP1641	ATE	PR 1ZC			
1.2 TFSI	63	05/10 →	FCP1094	ATE	PR 1ZG			
1.2 TFSI	63	05/10 →				FCP1491	LUCAS/TRW	PR 1KT
1.4 TFSI	136	01/11 →	FCP1641	ATE	PR 1ZC			
1.4 TFSI	136	01/11 →	FCP1094	ATE	PR 1ZG			
1.4 TFSI	136	01/11 →				FCP1491	LUCAS/TRW	PR 1KT
1.4 TFSI	90	05/10 →	FCP1641	ATE	PR 1ZC			
1.4 TFSI	90	05/10 →	FCP1094	ATE	PR 1ZG			
1.4 TFSI	90	05/10 →				FCP1491	LUCAS/TRW	PR 1KT
1.4 TFSI	103	04/12 →	FCP1641	ATE	PR 1LJ/1ZC			
1.4 TFSI	103	04/12 →	FCP1094	ATE	PR 1ZG			
1.4 TFSI	103	04/12 →				FCP1491	LUCAS/TRW	PR 1KT
1.6 TDI	66	03/11 →	FCP1641	ATE	PR 1ZC			
1.6 TDI	66	03/11 →	FCP1094	ATE	PR 1ZG			
1.6 TDI	66	03/11 →				FCP1491	LUCAS/TRW	PR 1KT
1.6 TDI	77	05/10 →	FCP1641	ATE	PR 1ZC			
1.6 TDI	77	05/10 →	FCP1094	ATE	PR 1ZG			
1.6 TDI	77	05/10 →				FCP1491	LUCAS/TRW	PR 1KT
2.0 TDI	100	05/12 →	FCP1641	ATE	PR 1ZC			
2.0 TDI	100	05/12 →	FCP1094	ATE	PR 1ZG			
2.0 TDI	100	05/12 →				FCP1491	LUCAS/TRW	PR 1KT
2.0 TDI	105	09/11 →	FCP1641	ATE	PR 1ZC			

For material availability see page 16-18 / Per la disponibilità materiali vedere a pagina 16-18



KW

**...AUDI****...A1 (8X1)**

2.0 TDI	105	09/11 →	FCP1094	ATE	PR 1ZG			
2.0 TDI	105	09/11 →				FCP1491	LUCAS/TRW	PR 1KT

A1 (8X1,8XK)

2.0 S1 Quattro	170	03/14 →	FCP1641	ATE				
----------------	-----	---------	---------	-----	--	--	--	--

A1 Sportback (8XA)

1.2 TFSI	63	01/12 →	FCP1641	ATE	PR 1LJ/1ZC			
1.2 TFSI	63	01/12 →	FCP1094	ATE	PR 1ZG			
1.2 TFSI	63	01/12 →				FCP1491	LUCAS/TRW	PR 1KT
1.4 TFSI	90	11/11 →	FCP1641	ATE	PR 1ZC			
1.4 TFSI	90	11/11 →	FCP1094	ATE	PR 1ZG			
1.4 TFSI	90	11/11 →				FCP1491	LUCAS/TRW	PR 1KT
1.4 TFSI	103	04/12 →	FCP1641	ATE	PR 1LJ/1ZC			
1.4 TFSI	103	04/12 →	FCP1094	ATE	PR 1ZG			
1.4 TFSI	103	04/12 →				FCP1491	LUCAS/TRW	PR 1KT
1.6 TDI	66	11/11 →	FCP1641	ATE	PR 1ZC			
1.6 TDI	66	11/11 →	FCP1094	ATE	PR 1ZG			
1.6 TDI	66	11/11 →				FCP1491	LUCAS/TRW	PR 1KT
1.6 TDI	77	11/11 →	FCP1641	ATE	PR 1ZC			
1.6 TDI	77	11/11 →	FCP1094	ATE	PR 1ZG			
1.6 TDI	77	11/11 →				FCP1491	LUCAS/TRW	PR 1KT
2.0 TDI	100	05/12 →	FCP1641	ATE	PR 1ZC			
2.0 TDI	100	05/12 →	FCP1094	ATE	PR 1ZG			
2.0 TDI	100	05/12 →				FCP1491	LUCAS/TRW	PR 1KT

A2

1.4 i	55	02/00 →	FCP1094	ATE				
1.4 TDi	55	02/00 →	FCP1094	ATE				
1.4 TDi	55	02/00 →				FCP1491	LUCAS/TRW	
1.6 FSi		05/02 → 08/05	FCP1094	ATE				
1.6 FSi		05/02 → 08/05				FCP541	LUCAS/TRW	

A3 (8L1)

1.6 i		10/96 → 12/00	FCP1094	ATE				
1.6 i		10/96 → 12/00				FCP541	LUCAS/TRW	
1.6 i	75	01/00 → 03/03	FCP1094	ATE				
1.6 i	75	01/00 → 03/03				FCP541	LUCAS/TRW	
1.8 20V		10/96 → 12/00	FCP1094	ATE				
1.8 20V		10/96 → 12/00				FCP541	LUCAS/TRW	
1.8 20V		01/00 → 03/03	FCP1094	ATE				
1.8 20V		01/00 → 03/03				FCP541	LUCAS/TRW	
1.8 Quattro	92	08/98 →	FCP1094	ATE				
1.8 Quattro	92	08/98 →				FCP1491	LUCAS/TRW	
1.8 T Sport 20V		10/96 → 12/00	FCP590	ATE				
1.8 T Sport 20V		10/96 → 12/00				FCP541	LUCAS/TRW	
1.8 T Sport, Quattro 20V	110	01/00 → 03/03	FCP590	ATE				
1.8 T Sport, Quattro 20V	110	01/00 → 03/03				FCP541	LUCAS/TRW	
1.9 TDi		10/96 → 12/00	FCP1094	ATE				
1.9 TDi		10/96 → 12/00				FCP541	LUCAS/TRW	
1.9 TDi		01/00 → 03/03	FCP1094	ATE				
1.9 TDi		01/00 → 03/03				FCP541	LUCAS/TRW	
1.9 TDi	96	08/00 →	FCP590	ATE				
1.9 TDi	96	08/00 →				FCP1491	LUCAS/TRW	
1.9 TDi Quattro	96	08/00 →	FCP590	ATE				
1.9 TDi Quattro	96	08/00 →				FCP1491	LUCAS/TRW	
S3 Quattro	154	01/99 →	FCP590	ATE				
S3 Quattro	154	01/99 →				FCP1491	LUCAS/TRW	
S3 Quattro	165	01/99 →	FCP590	ATE				
S3 Quattro	165	01/99 →				FCP1491	LUCAS/TRW	

A3 (8P1)

1.2 TSI	77	04/10 → 08/12	FCP4223	ATE	Disc Diam mm:345,For PR code:1ZK			
1.2 TSI	77	04/10 → 08/12	FCP1094	ATE				
1.2 TSI	77	04/10 → 08/12	FCP1641	ATE	Disc Diam mm:312/288,For PR code:1ZE,1LJ			
1.2 TSI	77	04/10 → 08/12				FCP1491	LUCAS/TRW	
1.4 TFSI	92	09/07 → 08/12	FCP4223	ATE	Disc Diam mm:345,For PR code:1ZK			
1.4 TFSI	92	09/07 → 08/12	FCP1641	ATE	Disc Diam mm:312/288,For PR code:1ZE,1ZP,1LJ			
1.4 TFSI	92	09/07 → 08/12				FCP1491	LUCAS/TRW	
1.6	75	05/03 → 08/12	FCP1094	ATE	For PR Number 1ZF,1ZM			
1.6	75	05/03 → 08/12	FCP1641	ATE	Disc Diam mm:312/288,For PR code:1ZE,1ZP,1LJ			
1.6	75	05/03 → 08/12	FCP4223	ATE	Disc Diam mm:345,For PR code:1ZK			
1.6	75	05/03 → 08/12				FCP1491	LUCAS/TRW	
1.6 E-Power	75	01/11 → 08/12	FCP4223	ATE	Disc Diam mm:345,For PR code:1ZK			
1.6 E-Power	75	01/11 → 08/12	FCP1094	ATE				
1.6 E-Power	75	01/11 → 08/12	FCP1641	ATE	Disc Diam mm:312,For PR code:1ZD			

For material availability see page 16-18 / Per la disponibilità materiali vedere a pagina 16-18

1016

FERODO

RACING

Updated on 17th Aug 2018



KW



...AUDI

...A3 (8P1)

			NOTE			NOTE		
1.6 E-Power	75	01/11 → 08/12				FCP1491	LUCAS/TRW	
1.6 FSI	85	08/03 → 09/07	FCP1094	ATE	For PR Number 1ZF,1ZM			
1.6 FSI	85	08/03 → 09/07	FCP1641	ATE	Disc Diam mm:312/288,For PR code:1ZE,1ZP,1LJ			
1.6 FSI	85	08/03 → 09/07	FCP4223	ATE	Disc Diam mm:345,For PR code:1ZK			
1.6 FSI	85	08/03 → 09/07				FCP1491	LUCAS/TRW	
1.6 TDI	66	05/09 → 08/12	FCP4223	ATE	Disc Diam mm:345,For PR code:1ZK			
1.6 TDI	66	05/09 → 08/12	FCP1094	ATE				
1.6 TDI	66	05/09 → 08/12	FCP1641	ATE	Disc Diam mm:312/288,For PR code:1ZE,1ZP,1LJ			
1.6 TDI	66	05/09 → 08/12				FCP1491	LUCAS/TRW	
1.6 TDI	77	05/09 → 08/12	FCP4223	ATE	Disc Diam mm:345,For PR code:1ZK			
1.6 TDI	77	05/09 → 08/12	FCP1094	ATE				
1.6 TDI	77	05/09 → 08/12	FCP1641	ATE	Disc Diam mm:312/288,For PR code:1ZA			
1.6 TDI	77	05/09 → 08/12				FCP1491	LUCAS/TRW	
1.8 TFSI	118	11/06 → 08/12	FCP1641	ATE	Disc Diam mm:312/288,For PR code:1ZE,1ZP,1LJ			
1.8 TFSI	118	11/06 → 08/12	FCP4223	ATE	Disc Diam mm:345,For PR code:1ZK			
1.8 TFSI	118	11/06 → 08/12				FCP1491	LUCAS/TRW	
1.8 TFSI quattro	118	07/08 → 08/12	FCP4223	ATE	Disc Diam mm:345,For PR code:1ZK			
1.8 TFSI quattro	118	07/08 → 08/12	FCP1641	ATE	Disc Diam mm:312/288,For PR code:1ZE,1ZP,1LJ			
1.8 TFSI quattro	118	07/08 → 08/12				FCP1636	LUCAS/TRW	For PR code:1KJ,For PR code-02:1X1
1.8 TFSI quattro	118	07/08 → 08/12				FCP4316	BOSCH	Disc Diam mm:272,For PR code:1KS
1.9 TDI	77	05/03 → 05/10	FCP1094	ATE	For PR Number 1ZF,1ZM			
1.9 TDI	77	05/03 → 05/10	FCP4223	ATE	Disc Diam mm:345,For PR code:1ZK			
1.9 TDI	77	05/03 → 05/10	FCP1641	ATE	Disc Diam mm:312/288,For PR code:1ZE,1ZP,1LJ			
1.9 TDI	77	05/03 → 05/10				FCP1636	LUCAS/TRW	
2.0 FSI	110	05/03 → 06/08	FCP1641	ATE	Disc Diam mm:312/288,For PR code:1ZE,1ZP,1LJ			
2.0 FSI	110	05/03 → 06/08	FCP4223	ATE	Disc Diam mm:345,For PR code:1ZK			
2.0 FSI	110	05/03 → 06/08				FCP1491	LUCAS/TRW	
2.0 TDI	100	05/03 → 08/12	FCP1641	ATE	Disc Diam mm:312/288,For PR code:1ZE,1ZP,1LJ			
2.0 TDI	100	05/03 → 08/12	FCP4223	ATE	Disc Diam mm:345,For PR code:1ZK			
2.0 TDI	100	05/03 → 08/12				FCP1491	LUCAS/TRW	
2.0 TDI	103	06/05 → 06/08	FCP1641	ATE	Disc Diam mm:312/288,For PR code:1ZE,1ZP,1LJ,1ZD			
2.0 TDI	103	06/05 → 06/08	FCP4223	ATE	Disc Diam mm:345,For PR code:1ZK			
2.0 TDI	103	06/05 → 06/08				FCP1491	LUCAS/TRW	
2.0 TDI	120	06/06 → 06/08	FCP4223	ATE	Disc Diam mm:345,For PR code:1ZK			
2.0 TDI	120	06/06 → 06/08	FCP1641	ATE	Disc Diam mm:312/288,For PR code:1ZE,1ZP,1LJ,1ZD			
2.0 TDI	120	06/06 → 06/08				FCP1491	LUCAS/TRW	
2.0 TDI 16V	103	05/03 → 08/12	FCP1641	ATE	Disc Diam mm:312/288,For PR code:1ZE,1ZP,1LJ			
2.0 TDI 16V	103	05/03 → 08/12	FCP4223	ATE	Disc Diam mm:345,For PR code:1ZK			
2.0 TDI 16V	103	05/03 → 08/12				FCP1491	LUCAS/TRW	
2.0 TDI 16V quattro	103	08/04 → 08/12	FCP4223	ATE	Disc Diam mm:345,For PR code:1ZK			
2.0 TDI 16V quattro	103	08/04 → 08/12	FCP1641	ATE	Disc Diam mm:312,For PR code:1ZD			
2.0 TDI 16V quattro	103	08/04 → 08/12				FCP1636	LUCAS/TRW	For PR code:1KF,1KJ,1X1
2.0 TDI 16V quattro	103	08/04 → 08/12				FCP4316	BOSCH	Disc Diam mm:272,For PR code:1KS
2.0 TDI quattro	103	01/06 → 06/08	FCP1641	ATE	Disc Diam mm:312/288,For PR:1ZE,1ZP,1LJ,1ZA,1ZD			
2.0 TDI quattro	103	01/06 → 06/08	FCP4223	ATE	Disc Diam mm:345,For PR code:1ZK			
2.0 TDI quattro	103	01/06 → 06/08				FCP1636	LUCAS/TRW	For PR code:1KF,1KJ,1X1
2.0 TDI quattro	125	03/06 → 08/12	FCP4223	ATE	Disc Diam mm:345,For PR code:1ZK			
2.0 TDI quattro	125	03/06 → 08/12	FCP1641	ATE	Disc Diam mm:312/288,For PR code:1ZE,1ZP,1LJ			
2.0 TDI quattro	125	03/06 → 08/12				FCP1636	LUCAS/TRW	For PR code:1KF,1KJ,1X1
2.0 TDI quattro	125	03/06 → 08/12				FCP4316	BOSCH	Disc Diam mm:272,For PR code:1KS
2.0 TFSI	147	09/04 → 08/12	FCP1641	ATE	Disc Diam mm:312/288,For PR code:1ZE,1ZP,1LJ			
2.0 TFSI	147	09/04 → 08/12	FCP4223	ATE	Disc Diam mm:345,For PR code:1ZK			
2.0 TFSI	147	09/04 → 08/12				FCP1636	LUCAS/TRW	For PR code:1X0/1KZ
2.0 TFSI	147	09/04 → 08/12				FCP4316	BOSCH	Disc Diam mm:272,For PR code:1KS
2.0 TFSI quattro	147	09/04 → 08/12	FCP1641	ATE	Disc Diam mm:312/288,For PR code:1ZE,1ZP,1LJ			
2.0 TFSI quattro	147	09/04 → 08/12	FCP4223	ATE	Disc Diam mm:345,For PR code:1ZK			
2.0 TFSI quattro	147	09/04 → 08/12				FCP1636	LUCAS/TRW	For PR code:1KF,1KJ,1X1
2.0 TFSI quattro	147	09/04 → 08/12				FCP4316	BOSCH	Disc Diam mm:272,For PR code:1KS
3.2 quattro	186	09/05 → 12/09	FCP4223	ATE				
3.2 quattro	186	09/05 → 12/09	FCP1765	ATE				
3.2 quattro	186	09/05 → 12/09				FCP1636	LUCAS/TRW	
3.2 V6 quattro	184	07/03 → 05/09	FCP1765	ATE	Disc Diam mm:345,For PR code:1LK			
3.2 V6 quattro	184	07/03 → 05/09	FCP4223	ATE	Disc Diam mm:345,For PR code:1ZK			
3.2 V6 quattro	184	07/03 → 05/09				FCP1636	LUCAS/TRW	For PR code:1KF,1KJ,1X1
S3 quattro	188	02/07 → 08/12	FCP1765	ATE				
S3 quattro	188	02/07 → 08/12	FCP4223	ATE	Disc Diam mm:345,For PR code:1ZK			
S3 quattro	188	02/07 → 08/12				FCP1636	LUCAS/TRW	For PR code:1KJ,For PR code-02:1X1
S3 quattro	188	02/07 → 08/12				FCP4316	BOSCH	
S3 quattro	195	11/06 → 08/12	FCP1765	ATE				
S3 quattro	195	11/06 → 08/12	FCP4223	ATE	Disc Diam mm:345,For PR code:1ZK			
S3 quattro	195	11/06 → 08/12				FCP1636	LUCAS/TRW	For PR code:1KJ,For PR code-02:1X1
S3 quattro	195	11/06 → 08/12				FCP4316	BOSCH	

For material availability see page 16-18 / Per la disponibilità materiali vedere a pagina 16-18



KW



...AUDI

A3 (8V1)

					NOTE			NOTE
S3 quattro	206	02/13 →	FCP4425	LUCAS/TRW				
S3 quattro	206	02/13 →				FCP4697	ATE	Disc Diam mm:310,For PR code:1KJ
S3 quattro	210	05/14 →	FCP4425	LUCAS/TRW				
S3 quattro	210	05/14 →				FCP4697	ATE	For PR code:1KY/1KJ
S3 quattro	221	11/12 →	FCP4425	LUCAS/TRW				
S3 quattro	221	11/12 →				FCP4697	ATE	Disc Diam mm:310,For PR code:1KJ

A3 (8V1, 8VK)

1.0 TFSI	85	07/16 →	FCP4433	TRW	Disc Diam mm:288,For PR code:1ZE			
1.0 TFSI	85	07/16 →				FCP4434	ATE	Disc Diam mm:272,For PR code:1KE
1.2 TFSI	77	02/13 →	FCP4433	LUCAS/TRW				
1.2 TFSI	77	02/13 →				FCP4697	ATE	Disc Diam mm:310,For PR code:1KY
1.2 TFSI	77	02/13 →				FCP4434	ATE	Disc Diam mm:272,For PR code:1KE
1.2 TFSI	81	05/14 →	FCP4433	LUCAS/TRW				
1.2 TFSI	81	05/14 →				FCP4697	ATE	Disc Diam mm:310,For PR code:1KY
1.2 TFSI	81	05/14 →				FCP4434	ATE	Disc Diam mm:272,For PR code:1KE
1.4 TFSI	103	10/12 →	FCP4433	LUCAS/TRW				
1.4 TFSI	103	03/13 →				FCP4697	ATE	Disc Diam mm:310,For PR code:1KY
1.4 TFSI	103	03/13 →				FCP4434	ATE	Disc Diam mm:272,For PR code:1KE
1.4 TFSI	110	05/14 →	FCP4433	LUCAS/TRW				
1.4 TFSI	110	05/14 →				FCP4697	ATE	Disc Diam mm:310,For PR code:1KY
1.4 TFSI	110	05/14 →				FCP4434	ATE	Disc Diam mm:272,For PR code:1KE
1.4 TFSI	90	04/12 →	FCP4433	LUCAS/TRW				
1.4 TFSI	90	04/12 →				FCP4697	ATE	Disc Diam mm:310,For PR code:1KY
1.4 TFSI	90	04/12 →				FCP4434	ATE	Disc Diam mm:272,For PR code:1KE
1.4 TFSI	92	05/14 →	FCP4433	LUCAS/TRW				
1.4 TFSI	92	05/14 →				FCP4697	ATE	Disc Diam mm:310,For PR code:1KY
1.4 TFSI	92	05/14 →				FCP4434	ATE	Disc Diam mm:272,For PR code:1KE
1.4 TFSI	92	05/14 →				FCP4697	ATE	Disc Diam mm:310,For PR code:1KY
1.4 TFSI	92	05/14 →				FCP4434	ATE	Disc Diam mm:272,For PR code:1KE
1.6 TDI	77	10/12 →	FCP4433	LUCAS/TRW				
1.6 TDI	77	10/12 →				FCP4697	ATE	Disc Diam mm:310,For PR code:1KY
1.6 TDI	77	10/12 →				FCP4434	ATE	Disc Diam mm:272,For PR code:1KE
1.6 TDI	81	09/13 →	FCP4433	LUCAS/TRW				
1.6 TDI	81	09/13 →				FCP4697	ATE	Disc Diam mm:310,For PR code:1KY
1.6 TDI	81	09/13 →				FCP4434	ATE	Disc Diam mm:272,For PR code:1KE
1.6 TDI	85	02/17 →	FCP4433	TRW	Disc Diam mm:288,For PR code:1ZE			
1.6 TDI	85	02/17 →				FCP4434	ATE	Disc Diam mm:272,For PR code:1KE/1KR
1.8 TFSI	132	04/12 →	FCP4433	LUCAS/TRW				
1.8 TFSI	132	04/12 →				FCP4697	ATE	Disc Diam mm:310,For PR code:1KY
1.8 TFSI	132	04/12 →				FCP4434	ATE	Disc Diam mm:272,For PR code:1KE
1.8 TFSI quattro	132	08/12 →	FCP4433	LUCAS/TRW				
1.8 TFSI quattro	132	08/12 →				FCP4434	ATE	Disc Diam mm:272,For PR code:1KE
2.0 TDI	100	05/13 →	FCP4433	LUCAS/TRW				
2.0 TDI	100	05/13 →				FCP4697	ATE	Disc Diam mm:310,For PR code:1KY
2.0 TDI	100	05/13 →				FCP4434	ATE	Disc Diam mm:272,For PR code:1KE
2.0 TDI	105	09/12 →	FCP4433	LUCAS/TRW				
2.0 TDI	105	09/12 →				FCP4697	ATE	Disc Diam mm:310,For PR code:1KY
2.0 TDI	105	09/12 →				FCP4434	ATE	Disc Diam mm:272,For PR code:1KE
2.0 TDI	110	04/12 →	FCP4433	LUCAS/TRW				
2.0 TDI	110	04/12 →				FCP4697	ATE	Disc Diam mm:310,For PR code:1KY
2.0 TDI	110	04/12 →				FCP4434	ATE	Disc Diam mm:272,For PR code:1KE
2.0 TDI	135	05/13 →	FCP4433	LUCAS/TRW				
2.0 TDI	135	05/13 →				FCP4697	ATE	Disc Diam mm:310,For PR code:1KY
2.0 TDI	135	05/13 →				FCP4434	ATE	Disc Diam mm:272,For PR code:1KE
2.0 TDI	81	01/13 →	FCP4433	LUCAS/TRW				
2.0 TDI	81	01/13 →				FCP4697	ATE	Disc Diam mm:310,For PR code:1KY
2.0 TDI	81	01/13 →				FCP4434	ATE	Disc Diam mm:272,For PR code:1KE
2.0 TDI quattro	110	10/12 →	FCP4433	LUCAS/TRW				
2.0 TDI quattro	110	10/12 →				FCP4434	ATE	Disc Diam mm:272,For PR code:1KE
2.0 TDI quattro	135	12/12 →	FCP4433	LUCAS/TRW				
2.0 TDI quattro	135	12/12 →				FCP4697	ATE	Disc Diam mm:310,For PR code:1KY
2.0 TDI quattro	135	12/12 →				FCP4434	ATE	Disc Diam mm:272,For PR code:1KE
2.0 TFSI	140	05/16 →	FCP4433	TRW	Disc Diam mm:288,For PR code:1ZE			
2.0 TFSI	140	05/16 →				FCP4434	ATE	Disc Diam mm:272,For PR code:1KE
2.0 TFSI quattro	140	05/16 →	FCP4433	TRW	Disc Diam mm:288,For PR code:1ZE			
2.0 TFSI quattro	140	05/16 →				FCP4434	ATE	Disc Diam mm:272,For PR code:1KE

A3 Cabrio (8P7)

1.2 TFSi 8v	77	03/10 →	FCP1094	ATE	PR 1ZF			
1.2 TFSi 8v	77	03/10 →	FCP1641	ATE	PR 1ZE/1LJ			
1.2 TFSi 8v	77	03/10 →				FCP4316	BOSCH	
1.4 TFSi 16v	92	02/11 →	FCP1094	ATE	PR 1ZF			
1.4 TFSi 16v	92	02/11 →	FCP1641	ATE	PR 1ZE/1LJ			
1.4 TFSi 16v	92	02/11 →				FCP4316	BOSCH	
1.6 8v	75	09/08 → 05/10	FCP1094	ATE	PR 1ZF			
1.6 8v	75	09/08 → 05/10	FCP1641	ATE	PR 1ZE/1LJ			
1.6 8v	75	09/08 → 05/10				FCP4316	BOSCH	
1.6 TDI 16v	77	05/09 →	FCP1094	ATE	PR 1ZF			

For material availability see page 16-18 / Per la disponibilità materiali vedere a pagina 16-18



KW

**...AUDI****...A3 Cabrio (8P7)**

					NOTE			NOTE
1.6 TDi 16v	77	05/09 →	FCP1641	ATE	PR 1ZE/1LJ			
1.6 TDi 16v	77	05/09 →				FCP4316	BOSCH	
1.8 FSI/TFSi 16v	118	04/08 →	FCP1094	ATE	PR 1ZF			
1.8 FSI/TFSi 16v	118	04/08 →	FCP1641	ATE	PR 1ZE/1LJ			
1.8 FSI/TFSi 16v	118	04/08 →				FCP4316	BOSCH	
1.9 TDi 8v	77	04/08 → 10/09	FCP1094	ATE	PR 1ZF			
1.9 TDi 8v	77	04/08 → 10/09	FCP1641	ATE	PR 1ZE/1LJ			
1.9 TDi 8v	77	04/08 → 10/09				FCP4316	BOSCH	
2.0 FSI/TFSi 16v	147	04/08 →	FCP1094	ATE	PR 1ZF			
2.0 FSI/TFSi 16v	147	04/08 →	FCP1641	ATE	PR 1ZE/1LJ			
2.0 FSI/TFSi 16v	147	04/08 →				FCP4316	BOSCH	
2.0 TDi 16v	100	04/08 → 05/13	FCP1094	ATE	PR 1ZF			
2.0 TDi 16v	100	04/08 → 05/13	FCP1641	ATE	PR 1ZE/1LJ			
2.0 TDi 16v	100	04/08 → 05/13				FCP4316	BOSCH	
2.0 TDi 16v	103	04/08 →	FCP1094	ATE	PR 1ZF			
2.0 TDi 16v	103	04/08 →	FCP1641	ATE	PR 1ZE/1LJ			
2.0 TDi 16v	103	04/08 →				FCP4316	BOSCH	

A3 Convertible (8V7)

S3 quattro	221	04/14 →	FCP4425	LUCAS/TRW				
S3 quattro	221	04/14 →				FCP4697	ATE	Disc Diam mm:310,For PR code:1KJ

A3 Convertible (8V7, 8VE)

1.4 TFSi	103	10/13 →	FCP4433	LUCAS/TRW				
1.4 TFSi	103	10/13 →				FCP4697	ATE	Disc Diam mm:310,For PR code:1KY
1.4 TFSi	103	10/13 →				FCP4434	ATE	Disc Diam mm:272,For PR code:1KE
1.4 TFSi	110	05/14 →	FCP4433	LUCAS/TRW				
1.4 TFSi	110	05/14 →				FCP4697	ATE	Disc Diam mm:310,For PR code:1KY
1.4 TFSi	110	05/14 →				FCP4434	ATE	Disc Diam mm:272,For PR code:1KE
1.4 TFSi	85	02/16 →	FCP4433	TRW	Disc Diam mm:288,For PR code:1ZE			
1.4 TFSi	85	02/16 →				FCP4434	ATE	Disc Diam mm:272,For PR code:2KE
1.4 TFSi	92	02/14 →	FCP4433	LUCAS/TRW				
1.4 TFSi	92	02/14 →				FCP4697	ATE	Disc Diam mm:310,For PR code:1KY
1.4 TFSi	92	02/14 →				FCP4434	ATE	Disc Diam mm:272,For PR code:1KE
1.6 TDi	81	02/14 →	FCP4433	LUCAS/TRW				
1.6 TDi	81	02/14 →				FCP4697	ATE	Disc Diam mm:310,For PR code:1KY
1.6 TDi	81	02/14 →				FCP4434	ATE	Disc Diam mm:272,For PR code:1KE
1.8 TFSi	125	05/14 →	FCP4433	LUCAS/TRW				
1.8 TFSi	125	05/14 →				FCP4697	ATE	For PR code:1KY/1KJ
1.8 TFSi	125	05/14 →				FCP4434	ATE	For PR code:1KE
1.8 TFSi	132	10/13 →	FCP4433	LUCAS/TRW				
1.8 TFSi	132	10/13 →				FCP4697	ATE	Disc Diam mm:310,For PR code:1KY
1.8 TFSi	132	10/13 →				FCP4434	ATE	Disc Diam mm:272,For PR code:1KE
1.8 TFSi quattro	132	03/14 →	FCP4433	LUCAS/TRW				
1.8 TFSi quattro	132	03/14 →				FCP4697	ATE	Disc Diam mm:310,For PR code:1KY
1.8 TFSi quattro	132	03/14 →				FCP4434	ATE	Disc Diam mm:272,For PR code:1KE
2.0 TDi	100	10/13 →	FCP4433	LUCAS/TRW				
2.0 TDi	100	10/13 →				FCP4697	ATE	Disc Diam mm:310,For PR code:1KY
2.0 TDi	100	10/13 →				FCP4434	ATE	Disc Diam mm:272,For PR code:1KE
2.0 TDi	110	10/13 →	FCP4433	LUCAS/TRW				
2.0 TDi	110	10/13 →				FCP4697	ATE	Disc Diam mm:310,For PR code:1KY
2.0 TDi	110	10/13 →				FCP4434	ATE	Disc Diam mm:272,For PR code:1KE
2.0 TDi	135	05/14 →	FCP4433	LUCAS/TRW				
2.0 TDi	135	05/14 →				FCP4697	ATE	Disc Diam mm:310,For PR code:1KY
2.0 TDi	135	05/14 →				FCP4434	ATE	Disc Diam mm:272,For PR code:1KE
2.0 TDi quattro	110	03/14 →	FCP4433	LUCAS/TRW				
2.0 TDi quattro	110	03/14 →				FCP4697	ATE	Disc Diam mm:310,For PR code:1KY
2.0 TDi quattro	110	03/14 →				FCP4434	ATE	Disc Diam mm:272,For PR code:1KE
2.0 TDi quattro	135	05/14 →	FCP4433	LUCAS/TRW				
2.0 TDi quattro	135	05/14 →				FCP4697	ATE	Disc Diam mm:310,For PR code:1KY
2.0 TDi quattro	135	05/14 →				FCP4434	ATE	Disc Diam mm:272,For PR code:1KE
2.0 TFSi	140	05/16 →	FCP4433	TRW	Disc Diam mm:288,For PR code:1ZE			
2.0 TFSi	140	05/16 →				FCP4434	ATE	Disc Diam mm:272,For PR code:1KE
2.0 TFSi	155	10/13 →	FCP4433	TRW				
2.0 TFSi	155	10/13 →				FCP4434	ATE	
2.0 TFSi quattro	140	05/16 →	FCP4433	TRW	Disc Diam mm:288,For PR code:1ZE			
2.0 TFSi quattro	140	05/16 →				FCP4434	ATE	Disc Diam mm:272,For PR code:1KE
2.0 TFSi quattro	162	05/14 →	FCP4433	TRW	Disc Diam mm:312,For PR code:1ZD			
2.0 TFSi quattro	162	05/14 →				FCP4434	ATE	Disc Diam mm:272,For PR code:1KE

A3 Limousine (8VS)

S3 quattro	206	10/13 →	FCP4433	LUCAS/TRW				
S3 quattro	206	10/13 →				FCP4697	ATE	Disc Diam mm:310,For PR code:1KJ
S3 quattro	210	05/14 →	FCP4433	LUCAS/TRW				
S3 quattro	210	05/14 →				FCP4697	ATE	For PR code:1KY/1KJ
S3 quattro	221	10/13 →	FCP4433	LUCAS/TRW				
S3 quattro	221	10/13 →				FCP4697	ATE	Disc Diam mm:310,For PR code:1KJ

For material availability see page 16-18 / Per la disponibilità materiali vedere a pagina 16-18



KW



...AUDI

A3 Limousine (8VS, 8VM)

					NOTE			NOTE
1.0 TFSI	85	07/16 →	FCP4433	TRW	Disc Diam mm:288,For PR code:1ZE	FCP4434	ATE	Disc Diam mm:272,For PR code:1KE
1.0 TFSI	85	07/16 →						
1.2 TFSI	77	10/13 →	FCP4433	TRW	For PR code:1ZE			
1.2 TFSI	77	10/13 →				FCP4434	ATE	For PR code:1KE
1.2 TFSI	81	05/14 →	FCP4433	LUCAS/TRW				
1.2 TFSI	81	05/14 →				FCP4697	ATE	For PR code:2ED;1KY/1KJ
1.2 TFSI	81	05/14 →				FCP4434	ATE	For PR code:1KE
1.4 TFSI	103	05/13 →	FCP4433	LUCAS/TRW				
1.4 TFSI	103	05/13 →				FCP4697	ATE	Disc Diam mm:310,For PR code:1KJ/1KY
1.4 TFSI	103	05/13 →				FCP4434	ATE	Disc Diam mm:272,For PR code:1KE
1.4 TFSI	110	05/14 →	FCP4433	LUCAS/TRW				
1.4 TFSI	110	05/14 →				FCP4697	ATE	Disc Diam mm:310,For PR code:1KY
1.4 TFSI	110	05/14 →				FCP4434	ATE	Disc Diam mm:272,For PR code:1KE
1.4 TFSI	90	09/13 →	FCP4433	LUCAS/TRW				
1.4 TFSI	90	09/13 →				FCP4697	ATE	Disc Diam mm:310,For PR code:1KY
1.4 TFSI	90	09/13 →				FCP4434	ATE	Disc Diam mm:272,For PR code:1KE
1.4 TFSI	92	09/13 →	FCP4433	LUCAS/TRW				
1.4 TFSI	92	09/13 →				FCP4697	ATE	Disc Diam mm:310,For PR code:1KY
1.4 TFSI	92	09/13 →				FCP4434	ATE	Disc Diam mm:272,For PR code:1KE
1.4 TFSI Flex	110	01/17 →	FCP4433	TRW				
1.4 TFSI Flex	110	01/17 →				FCP4434	ATE	
1.5 TFSI	110	05/17 →	FCP4433	TRW	Disc Diam mm:288,For PR code:1ZE			
1.5 TFSI	110	05/17 →				FCP4434	ATE	Disc Diam mm:272,For PR code:1KE
1.6 TDI	77	09/13 →	FCP4433	LUCAS/TRW				
1.6 TDI	77	09/13 →				FCP4697	ATE	Disc Diam mm:310,For PR code:1KY
1.6 TDI	77	09/13 →				FCP4434	ATE	Disc Diam mm:272,For PR code:1KE
1.6 TDI	81	05/14 →	FCP4433	LUCAS/TRW				
1.6 TDI	81	05/14 →				FCP4697	ATE	Disc Diam mm:310,For PR code:1KY
1.6 TDI	81	05/14 →				FCP4434	ATE	Disc Diam mm:272,For PR code:1KE
1.6 TDI	85	03/17 →	FCP4433	TRW	Disc Diam mm:288,For PR code:1ZE			
1.6 TDI	85	03/17 →				FCP4434	ATE	Disc Diam mm:272,For PR code:1KE/1KR
1.6 TDI quattro	81	05/15 →	FCP4433	LUCAS/TRW	Pr Number 1ZE			
1.6 TDI quattro	81	05/15 →				FCP4697	ATE	For PR code:1KY/1KJ/2ED
1.6 TDI quattro	81	05/15 →				FCP4434	ATE	For PR code:1KE
1.8 TFSI	125	11/13 →	FCP4433	LUCAS/TRW				
1.8 TFSI	125	11/13 →				FCP4697	ATE	For PR code:2ED;1KY/1KJ
1.8 TFSI	125	11/13 →				FCP4434	ATE	For PR code:1KE
1.8 TFSI	132	05/13 →	FCP4433	LUCAS/TRW				
1.8 TFSI	132	05/13 →				FCP4697	ATE	Disc Diam mm:310,For PR code:1KY
1.8 TFSI	132	05/13 →				FCP4434	ATE	Disc Diam mm:272,For PR code:1KE
1.8 TFSI quattro	132	11/13 →	FCP4433	LUCAS/TRW				
1.8 TFSI quattro	132	11/13 →				FCP4697	ATE	Disc Diam mm:310,For PR code:1KY
1.8 TFSI quattro	132	11/13 →				FCP4434	ATE	Disc Diam mm:272,For PR code:1KE
2.0 TDI	100	09/13 →	FCP4433	LUCAS/TRW				
2.0 TDI	100	09/13 →				FCP4697	ATE	Disc Diam mm:310,For PR code:1KY
2.0 TDI	100	09/13 →				FCP4434	ATE	Disc Diam mm:272,For PR code:1KE
2.0 TDI	105	10/13 →	FCP4433	LUCAS/TRW				
2.0 TDI	105	10/13 →				FCP4697	ATE	Disc Diam mm:310,For PR code:1KY
2.0 TDI	105	10/13 →				FCP4434	ATE	Disc Diam mm:272,For PR code:1KE
2.0 TDI	110	05/13 →	FCP4433	LUCAS/TRW				
2.0 TDI	110	05/13 →				FCP4697	ATE	Disc Diam mm:310,For PR code:1KY
2.0 TDI	110	05/13 →				FCP4434	ATE	Disc Diam mm:272,For PR code:1KE
2.0 TDI	135	05/14 →	FCP4433	LUCAS/TRW				
2.0 TDI	135	05/14 →				FCP4697	ATE	Disc Diam mm:310,For PR code:1KY
2.0 TDI	135	05/14 →				FCP4434	ATE	Disc Diam mm:272,For PR code:1KE
2.0 TDI	81	05/13 →	FCP4433	LUCAS/TRW				
2.0 TDI	81	05/13 →				FCP4697	ATE	Disc Diam mm:310,For PR code:1KY
2.0 TDI	81	05/13 →				FCP4434	ATE	Disc Diam mm:272,For PR code:1KE
2.0 TDI quattro	110	10/13 →				FCP4434	ATE	Disc Diam mm:272,For PR code:1KE
2.0 TDI quattro	135	05/14 →	FCP4433	LUCAS/TRW				
2.0 TDI quattro	135	05/14 →				FCP4697	ATE	Disc Diam mm:310,For PR code:1KY
2.0 TDI quattro	135	05/14 →				FCP4434	ATE	Disc Diam mm:272,For PR code:1KE
2.0 TFSI	140	05/16 →	FCP4433	TRW	Disc Diam mm:288,For PR code:1ZE			
2.0 TFSI	140	05/16 →				FCP4434	ATE	Disc Diam mm:272,For PR code:1KE
2.0 TFSI	162	11/15 →	FCP4433	TRW	Disc Diam mm:288,For PR code:1ZE			
2.0 TFSI	162	11/15 →				FCP4434	ATE	Disc Diam mm:272,For PR code:1KE
2.0 TFSI Flex	162	01/17 →	FCP4433	TRW				
2.0 TFSI Flex	162	01/17 →				FCP4434	ATE	
2.0 TFSI quattro	140	05/16 →	FCP4433	TRW	Disc Diam mm:288,For PR code:1ZE			
2.0 TFSI quattro	140	05/16 →				FCP4434	ATE	Disc Diam mm:272,For PR code:1KE
2.0 TFSI quattro	162	11/13 →	FCP4433	TRW				
2.0 TFSI quattro	162	11/13 →				FCP4434	ATE	

For material availability see page 16-18 / Per la disponibilità materiali vedere a pagina 16-18

1020

FERODO

RACING

Updated on 17th Aug 2018



KW



...AUDI

A3 Sportback (8PA)

				NOTE				NOTE	
1.2 TSI	77 04/10 → 03/13	FCP4223	ATE	Disc Diam mm:345,For PR code:1ZK					
1.2 TSI	77 04/10 → 03/13	FCP1094	ATE						
1.2 TSI	77 04/10 → 03/13	FCP1641	ATE	Disc Diam mm:312/288,For PR code:1ZE,1ZP,1LJ					
1.2 TSI	77 04/10 → 03/13				FCP1491	LUCAS/TRW			
1.4 TFSI	92 09/07 → 03/13	FCP4223	ATE	Disc Diam mm:345,For PR code:1ZK					
1.4 TFSI	92 09/07 → 03/13	FCP1641	ATE	Disc Diam mm:312/288,For PR code:1ZE,1ZP,1LJ					
1.4 TFSI	92 09/07 → 03/13				FCP1491	LUCAS/TRW			
1.6	75 09/04 → 03/13	FCP1094	ATE						
1.6	75 09/04 → 03/13	FCP1641	ATE	Disc Diam mm:312/288,For PR code:1ZE,1ZP,1LJ					
1.6	75 09/04 → 03/13	FCP4223	ATE	Disc Diam mm:345,For PR code:1ZK					
1.6	75 09/04 → 03/13				FCP1491	LUCAS/TRW			
1.6 E-Power	75 01/11 → 03/13	FCP4223	ATE	Disc Diam mm:345,For PR code:1ZK					
1.6 E-Power	75 01/11 → 03/13	FCP1094	ATE						
1.6 E-Power	75 01/11 → 03/13	FCP1641	ATE	Disc Diam mm:312/288,For PR code:1ZE,1ZP,1LJ					
1.6 E-Power	75 01/11 → 03/13				FCP1491	LUCAS/TRW			
1.6 FSI	85 09/04 → 09/07	FCP1094	ATE						
1.6 FSI	85 09/04 → 09/07	FCP1641	ATE	Disc Diam mm:312/288,For PR code:1ZE,1ZP,1LJ,1ZD					
1.6 FSI	85 09/04 → 09/07	FCP4223	ATE	Disc Diam mm:345,For PR code:1ZK					
1.6 FSI	85 09/04 → 09/07				FCP1636	LUCAS/TRW			
1.6 FSI	85 09/04 → 09/07				FCP1491	LUCAS/TRW			
1.6 TDI	66 05/09 → 03/13	FCP4223	ATE	Disc Diam mm:345,For PR code:1ZK					
1.6 TDI	66 05/09 → 03/13	FCP1094	ATE						
1.6 TDI	66 05/09 → 03/13	FCP1641	ATE	Disc Diam mm:312/288,For PR code:1ZE,1ZP,1LJ					
1.6 TDI	66 05/09 → 03/13				FCP1491	LUCAS/TRW			
1.6 TDI	77 05/09 → 03/13	FCP4223	ATE	Disc Diam mm:345,For PR code:1ZK					
1.6 TDI	77 05/09 → 03/13	FCP1094	ATE						
1.6 TDI	77 05/09 → 03/13	FCP1641	ATE	Disc Diam mm:312/288,For PR code:1ZE,1ZP,1LJ					
1.6 TDI	77 05/09 → 03/13				FCP1491	LUCAS/TRW			
1.8 TFSI	118 11/06 → 03/13	FCP4223	ATE	Disc Diam mm:345,For PR code:1ZK					
1.8 TFSI	118 11/06 → 03/13	FCP1641	ATE	Disc Diam mm:312/288,For PR code:1ZE,1ZP,1LJ					
1.8 TFSI	118 11/06 → 03/13				FCP1491	LUCAS/TRW			
1.8 TFSI quattro	118 07/08 → 03/13	FCP4223	ATE	Disc Diam mm:345,For PR code:1ZK					
1.8 TFSI quattro	118 07/08 → 03/13	FCP1641	ATE	Disc Diam mm:312/288,For PR code:1ZE,1ZP,1LJ					
1.8 TFSI quattro	118 07/08 → 03/13				FCP1636	LUCAS/TRW			For PR code:1KJ,For PR code:02:1X1
1.8 TFSI quattro	118 07/08 → 03/13				FCP4316	BOSCH			Disc Diam mm:272,For PR code:1KS
1.9 TDI	77 09/04 → 05/10	FCP1094	ATE						
1.9 TDI	77 09/04 → 05/10	FCP4223	ATE	Disc Diam mm:345,For PR code:1ZK					
1.9 TDI	77 09/04 → 05/10	FCP1641	ATE	Disc Diam mm:312/288,For PR code:1ZE,1ZP,1LJ					
1.9 TDI	77 09/04 → 05/10				FCP1636	LUCAS/TRW			
2.0 FSI	110 09/04 → 06/08	FCP1641	ATE	Disc Diam mm:312/288,For PR code:1ZE,1ZP,1LJ,1ZD					
2.0 FSI	110 09/04 → 06/08	FCP4223	ATE	Disc Diam mm:345,For PR code:1ZK					
2.0 FSI	110 09/04 → 06/08				FCP1636	LUCAS/TRW			
2.0 FSI	110 09/04 → 06/08				FCP1491	LUCAS/TRW			
2.0 TDI	100 09/04 → 03/13	FCP1641	ATE	Disc Diam mm:312/288,For PR code:1ZE,1ZP,1LJ					
2.0 TDI	100 09/04 → 03/13	FCP4223	ATE	Disc Diam mm:345,For PR code:1ZK					
2.0 TDI	100 09/04 → 03/13				FCP1491	LUCAS/TRW			
2.0 TDI	103 06/05 → 06/08	FCP1641	ATE	Disc Diam mm:312/288,For PR code:1ZE,1ZP,1LJ,1ZD					
2.0 TDI	103 06/05 → 06/08	FCP4223	ATE	Disc Diam mm:345,For PR code:1ZK					
2.0 TDI	103 06/05 → 06/08				FCP1636	LUCAS/TRW			PR 1KF,1KJ,1KZ (255mm disc)
2.0 TDI	103 06/05 → 06/08				FCP541	LUCAS/TRW			260mm disc
2.0 TDI	103 06/05 → 06/08				FCP1491	LUCAS/TRW			
2.0 TDI	104 01/10 → 03/13	FCP4223	ATE						
2.0 TDI	104 01/10 → 03/13	FCP1641	ATE						
2.0 TDI	104 01/10 → 03/13				FCP1636	LUCAS/TRW			
2.0 TDI	120 06/06 → 06/08	FCP4223	ATE	Disc Diam mm:345,For PR code:1ZK					
2.0 TDI	120 06/06 → 06/08	FCP1641	ATE	Disc Diam mm:312/288,For PR code:1ZE,1ZP,1LJ,1ZD					
2.0 TDI	120 06/06 → 06/08				FCP1491	LUCAS/TRW			
2.0 TDI 16V	103 09/04 → 03/13	FCP4223	ATE	Disc Diam mm:345,For PR code:1ZK					
2.0 TDI 16V	103 09/04 → 03/13	FCP1641	ATE	Disc Diam mm:312/288,For PR code:1ZE,1ZP,1LJ					
2.0 TDI 16V	103 09/04 → 03/13				FCP1491	LUCAS/TRW			
2.0 TDI 16V quattro	103 11/05 → 03/13	FCP4223	ATE	Disc Diam mm:345,For PR code:1ZK					
2.0 TDI 16V quattro	103 11/05 → 03/13	FCP1641	ATE	Disc Diam mm:312/288,For PR code:1ZE,1ZP,1LJ					
2.0 TDI 16V quattro	103 11/05 → 03/13				FCP1636	LUCAS/TRW			For PR code:1KF,1KJ,1X1
2.0 TDI 16V quattro	103 11/05 → 03/13				FCP4316	BOSCH			Disc Diam mm:272,For PR code:1KS
2.0 TDI quattro	103 01/06 → 06/08	FCP1641	ATE	Disc Diam mm:312/288,For PR 1ZE,1ZP,1LJ,1ZA,1ZD					
2.0 TDI quattro	103 01/06 → 06/08	FCP4223	ATE	Disc Diam mm:345,For PR code:1ZK					
2.0 TDI quattro	103 01/06 → 06/08				FCP1636	LUCAS/TRW			For PR code:1KF,1KJ,1X1
2.0 TDI quattro	125 03/06 → 03/13	FCP1641	ATE	Disc Diam mm:312/288,For PR code:1ZE,1ZP,1LJ					
2.0 TDI quattro	125 03/06 → 03/13	FCP4223	ATE	Disc Diam mm:345,For PR code:1ZK					
2.0 TDI quattro	125 03/06 → 03/13				FCP1636	LUCAS/TRW			For PR code:1KF,1KJ,1X1
2.0 TDI quattro	125 03/06 → 03/13				FCP4316	BOSCH			Disc Diam mm:272,For PR code:1KS
2.0 TFSI	147 09/04 → 03/13	FCP1641	ATE	Disc Diam mm:312/288,For PR code:1ZE,1ZP,1LJ					
2.0 TFSI	147 09/04 → 03/13	FCP4223	ATE	Disc Diam mm:345,For PR code:1ZK					
2.0 TFSI	147 09/04 → 03/13				FCP1636	LUCAS/TRW			For PR code:1X0/1KZ
2.0 TFSI	147 09/04 → 03/13				FCP4316	BOSCH			Disc Diam mm:272,For PR code:1KS
2.0 TFSI quattro	147 09/04 → 03/13	FCP1641	ATE	Disc Diam mm:312/288,For PR code:1ZE,1ZP,1LJ					
2.0 TFSI quattro	147 09/04 → 03/13	FCP4223	ATE	Disc Diam mm:345,For PR code:1ZK					
2.0 TFSI quattro	147 09/04 → 03/13				FCP1636	LUCAS/TRW			For PR code:1KF,1KJ,1X1

For material availability see page 16-18 / Per la disponibilità materiali vedere a pagina 16-18

AUDI



KW

**...AUDI****NOTE****NOTE****...A3 Sportback (8PA)**

2.0 TFSI quattro	147	09/04 → 03/13	FCP1765	ATE	Disc Diam mm:345,For PR code:1LK	FCP4316	BOSCH	Disc Diam mm:272,For PR code:1KS
3.2 V6 quattro	184	09/04 → 05/09	FCP4223	ATE	Disc Diam mm:345,For PR code:1ZK			
3.2 V6 quattro	184	09/04 → 05/09				FCP1636	LUCAS/TRW	For PR code:1KF,1KJ,1X1
RS3 quattro	250	01/11 → 12/12	FCP1334	BREMBO		FCP1636	LUCAS/TRW	
RS3 quattro	250	01/11 → 12/12						
S3 quattro	188	07/08 → 03/13	FCP4223	ATE	Disc Diam mm:345,For PR code:1ZK	FCP1636	LUCAS/TRW	For PR code:1KJ,For PR code-02:1X1
S3 quattro	188	07/08 → 03/13						
S3 quattro	195	06/08 → 03/13	FCP4223	ATE	Disc Diam mm:345,For PR code:1ZK	FCP1636	LUCAS/TRW	For PR code:1KJ,For PR code-02:1X1
S3 quattro	195	06/08 → 03/13						

A3 Sportback (8VA)

S3 quattro	206	05/13 →	FCP4425	LUCAS/TRW				
S3 quattro	206	05/13 →				FCP4697	ATE	Disc Diam mm:310,For PR code:1KJ
S3 quattro	210	05/14 →	FCP4433	LUCAS/TRW				
S3 quattro	210	05/14 →				FCP4697	ATE	For PR code:1KY/1KJ
S3 quattro	221	11/12 →	FCP4425	LUCAS/TRW				
S3 quattro	221	11/12 →				FCP4697	ATE	Disc Diam mm:310,For PR code:1KJ

A3 Sportback (8VA, 8VF)

1.0 TFSI	85	07/16 →	FCP4433	TRW	Disc Diam mm:288,For PR code:1ZE			
1.0 TFSI	85	07/16 →				FCP4434	ATE	Disc Diam mm:272,For PR code:1KE
1.2 TFSI	77	05/13 →	FCP4433	LUCAS/TRW				
1.2 TFSI	77	05/13 →				FCP4697	ATE	Disc Diam mm:310,For PR code:1KY
1.2 TFSI	77	05/13 →				FCP4434	ATE	Disc Diam mm:272,For PR code:1KE
1.2 TFSI	81	05/14 →	FCP4433	LUCAS/TRW				
1.2 TFSI	81	05/14 →				FCP4697	ATE	Disc Diam mm:310,For PR code:1KY
1.2 TFSI	81	05/14 →				FCP4434	ATE	Disc Diam mm:272,For PR code:1KE
1.4 TFSI	103	03/13 →	FCP4433	LUCAS/TRW				
1.4 TFSI	103	03/13 →				FCP4697	ATE	Disc Diam mm:310,For PR code:1KY
1.4 TFSI	103	03/13 →				FCP4434	ATE	Disc Diam mm:272,For PR code:1KE
1.4 TFSI	110	05/14 →	FCP4433	LUCAS/TRW				
1.4 TFSI	110	05/14 →				FCP4697	ATE	Disc Diam mm:310,For PR code:1KY
1.4 TFSI	110	05/14 →				FCP4434	ATE	Disc Diam mm:272,For PR code:1KE
1.4 TFSI	90	09/12 →	FCP4433	LUCAS/TRW				
1.4 TFSI	90	09/12 →				FCP4697	ATE	Disc Diam mm:310,For PR code:1KY
1.4 TFSI	90	09/12 →				FCP4434	ATE	Disc Diam mm:272,For PR code:1KE
1.4 TFSI	92	05/14 →	FCP4433	LUCAS/TRW				
1.4 TFSI	92	05/14 →				FCP4697	ATE	Disc Diam mm:310,For PR code:1KY
1.4 TFSI	92	05/14 →				FCP4434	ATE	Disc Diam mm:272,For PR code:1KE
1.4 TFSI e-tron	110	05/14 →	FCP4433	LUCAS/TRW				
1.4 TFSI e-tron	110	05/14 →				FCP4697	ATE	Disc Diam mm:310,For PR code:1KY
1.4 TFSI e-tron	110	05/14 →				FCP4434	ATE	Disc Diam mm:272,For PR code:1KE
1.4 TFSI e-tron	150	05/14 →	FCP4433	TRW				
1.4 TFSI e-tron	150	05/14 →				FCP4434	ATE	
1.4 TFSI g-tron	81	11/13 →	FCP4433	LUCAS/TRW				
1.4 TFSI g-tron	81	11/13 →				FCP4697	ATE	Disc Diam mm:310,For PR code:1KY
1.4 TFSI g-tron	81	11/13 →				FCP4434	ATE	Disc Diam mm:272,For PR code:1KE
1.6 TDI	77	10/12 →	FCP4433	LUCAS/TRW				
1.6 TDI	77	10/12 →				FCP4697	ATE	Disc Diam mm:310,For PR code:1KY
1.6 TDI	77	10/12 →				FCP4434	ATE	Disc Diam mm:272,For PR code:1KE
1.6 TDI	81	09/13 →	FCP4433	LUCAS/TRW				
1.6 TDI	81	09/13 →				FCP4697	ATE	Disc Diam mm:310,For PR code:1KY
1.6 TDI	81	09/13 →				FCP4434	ATE	Disc Diam mm:272,For PR code:1KE
1.6 TDI	85	02/17 →	FCP4433	TRW	Disc Diam mm:288,For PR code:1ZE			
1.6 TDI	85	02/17 →				FCP4434	ATE	Disc Diam mm:272,For PR code:1KE
1.6 TDI quattro	81	05/15 →	FCP4433	LUCAS/TRW	Pr Number 1ZE			
1.6 TDI quattro	81	05/15 →				FCP4697	ATE	For PR code:1KY/1KJ/2ED
1.6 TDI quattro	81	05/15 →				FCP4434	ATE	For PR code:1KE
1.8 TFSI	132	09/12 →	FCP4433	LUCAS/TRW				
1.8 TFSI	132	09/12 →				FCP4697	ATE	Disc Diam mm:310,For PR code:1KY
1.8 TFSI	132	09/12 →				FCP4434	ATE	Disc Diam mm:272,For PR code:1KE
1.8 TFSI quattro	132	05/13 →	FCP4433	LUCAS/TRW				
1.8 TFSI quattro	132	05/13 →				FCP4697	ATE	Disc Diam mm:310,For PR code:1KY
1.8 TFSI quattro	132	05/13 →				FCP4434	ATE	Disc Diam mm:272,For PR code:1KE
2.0 TDI	100	05/13 →	FCP4433	LUCAS/TRW				
2.0 TDI	100	05/13 →				FCP4697	ATE	Disc Diam mm:310,For PR code:1KY
2.0 TDI	100	05/13 →				FCP4434	ATE	Disc Diam mm:272,For PR code:1KE
2.0 TDI	105	03/13 →	FCP4433	LUCAS/TRW				
2.0 TDI	105	03/13 →				FCP4697	ATE	Disc Diam mm:310,For PR code:1KY
2.0 TDI	105	03/13 →				FCP4434	ATE	Disc Diam mm:272,For PR code:1KE
2.0 TDI	110	09/12 →	FCP4433	LUCAS/TRW				
2.0 TDI	110	09/12 →				FCP4697	ATE	Disc Diam mm:310,For PR code:1KY
2.0 TDI	110	09/12 →				FCP4434	ATE	Disc Diam mm:272,For PR code:1KE
2.0 TDI	135	05/13 →	FCP4433	LUCAS/TRW				
2.0 TDI	135	05/13 →				FCP4697	ATE	Disc Diam mm:310,For PR code:1KY
2.0 TDI	135	05/13 →				FCP4434	ATE	Disc Diam mm:272,For PR code:1KE

For material availability see page 16-18 / Per la disponibilità materiali vedere a pagina 16-18



KW



...AUDI

...A3 Sportback (8VA, 8VF)

					NOTE			NOTE
2.0 TDI	81	05/13 →	FCP4433	LUCAS/TRW				
2.0 TDI	81	05/13 →				FCP4697	ATE	Disc Diam mm:310,For PR code:1KY
2.0 TDI	81	05/13 →				FCP4434	ATE	Disc Diam mm:272,For PR code:1KE
2.0 TDI quattro	110	11/12 →	FCP4433	LUCAS/TRW				
2.0 TDI quattro	110	02/13 →				FCP4697	ATE	Disc Diam mm:310,For PR code:1KY
2.0 TDI quattro	110	02/13 →				FCP4434	ATE	Disc Diam mm:272,For PR code:1KE
2.0 TDI quattro	135	05/13 →	FCP4433	LUCAS/TRW				
2.0 TDI quattro	135	05/13 →				FCP4697	ATE	Disc Diam mm:310,For PR code:1KY
2.0 TDI quattro	135	05/13 →				FCP4434	ATE	Disc Diam mm:272,For PR code:1KE
2.0 TFSI	140	05/16 →	FCP4433	TRW	Disc Diam mm:288,For PR code:1ZE			
2.0 TFSI	140	05/16 →				FCP4434	ATE	Disc Diam mm:272,For PR code:1KE
2.0 TFSI	162	02/15 →	FCP4433	TRW				
2.0 TFSI	162	02/15 →				FCP4434	ATE	
2.0 TFSI quattro	140	05/16 →	FCP4433	TRW	Disc Diam mm:288,For PR code:1ZE			
2.0 TFSI quattro	140	05/16 →				FCP4434	ATE	Disc Diam mm:272,For PR code:1KE
RS3 quattro	270	03/15 →	FCP1094	ATE	For PR number 1ZF			
RS3 quattro	270	03/15 →	FCP1664	BREMBO	For PR number 1LU,1LH			
RS3 quattro	270	03/15 →				FCP4697	ATE	For PR number 2EE,1KX
RS3 quattro	294	04/17 →	FCP1664	BREMBO	For PR number 1LU,1LH			

A4 (8D2, B5)

1.8 quattro	92	08/97 → 02/99	FCP775	LUCAS/TRW				
1.8 quattro	92	08/97 → 02/99	FCP1289	LUCAS/TRW				
1.8 T	132	12/97 → 11/00	FCP1323	ATE				
1.8 T quattro	110	01/95 → 11/00	FCP1323	ATE				
1.8 T quattro	132	03/99 → 11/00	FCP1323	ATE				
1.9 Tdi quattro	81	03/99 → 11/00	FCP1323	ATE				
1.9 Tdi quattro	85	03/00 → 11/00	FCP775	LUCAS/TRW				
1.9 Tdi quattro	85	03/00 → 11/00	FCP1323	ATE				
2.4	120	03/99 → 11/00	FCP1323	ATE				
2.4 quattro	121	03/97 → 02/99	FCP590	ATE				
2.4 quattro	121	03/97 → 02/99				FCP541	LUCAS/TRW	
2.4 quattro	120	03/99 → 11/00	FCP1323	ATE				
2.5 TDI quattro	110	01/97 → 02/99	FCP590	ATE				
2.5 TDI quattro	110	01/97 → 02/99				FCP541	LUCAS/TRW	
2.6 quattro	110	01/95 → 02/99	FCP590	ATE				
2.6 quattro	110	01/95 → 02/99				FCP596	LUCAS/TRW	
2.8 quattro	128	01/95 → 07/97	FCP590	ATE				
2.8 quattro	128	01/95 → 07/97				FCP596	LUCAS/TRW	
2.8 quattro	142	10/96 → 02/99	FCP590	ATE				
2.8 quattro	142	10/96 → 02/99				FCP596	LUCAS/TRW	
S4 quattro	195	09/97 → 09/01	FCP1629	ATE				
S4 quattro	195	09/97 → 09/01				FCP1491	LUCAS/TRW	

A4 (8E2, B6)

1.6	75	11/00 → 12/04	FCP1717	ATE	PR 1LB,1LE(288mm disc)1LT,1LF(312mm disc)			
1.6	75	11/00 → 12/04				FCP1491	LUCAS/TRW	
1.8 T	120	07/02 → 12/04	FCP1717	ATE	PR 1LB,1LE(288mm disc)1LT,1LF(312mm disc)			
1.8 T	120	07/02 → 12/04				FCP1491	LUCAS/TRW	
1.8 T	125	07/01 → 12/04	FCP1717	ATE	PR 1LB,1LE(288mm disc)1LT,1LF(312mm disc)			
1.8 T	125	07/01 → 12/04				FCP1491	LUCAS/TRW	
1.8 T	140	11/02 → 12/04	FCP1717	ATE	PR 1LB,1LE(288mm disc)1LT,1LF(312mm disc)			
1.8 T	140	11/02 → 12/04				FCP1491	LUCAS/TRW	
1.8 T quattro	110	11/00 → 07/02	FCP1717	ATE	PR 1LB,1LE(288mm disc)1LT,1LF(312mm disc)			
1.8 T quattro	110	11/00 → 07/02				FCP1491	LUCAS/TRW	
1.8 T quattro	120	07/02 → 12/04	FCP1717	ATE	PR 1LB,1LE(288mm disc)1LT,1LF(312mm disc)			
1.8 T quattro	125	07/01 → 12/04	FCP1717	ATE	PR 1LB,1LE(288mm disc)1LT,1LF(312mm disc)			
1.8 T quattro	125	07/01 → 12/04				FCP1491	LUCAS/TRW	
1.8 T quattro	140	11/02 → 12/04	FCP1717	ATE	PR 1LB,1LE(288mm disc)1LT,1LF(312mm disc)			
1.8 T quattro	140	11/02 → 12/04				FCP1491	LUCAS/TRW	
1.9 TDI	74	05/01 → 12/04	FCP1717	ATE	PR 1LB,1LE(288mm disc)1LT,1LF(312mm disc)			
1.9 TDI	74	05/01 → 12/04				FCP1491	LUCAS/TRW	
1.9 TDI quattro	96	11/01 → 12/04	FCP1717	ATE	PR 1LB,1LE(288mm disc)1LT,1LF(312mm disc)			
1.9 TDI quattro	96	11/01 → 12/04				FCP1491	LUCAS/TRW	
2.0 i	96	11/00 → 10/04	FCP1323	ATE				
2.0 i	96	11/00 → 12/04	FCP1717	ATE	PR 1LB,1LE(288mm disc)1LT,1LF(312mm disc)			
2.0 i	96	11/00 → 12/04				FCP1491	LUCAS/TRW	
2.4	120	09/01 → 12/04	FCP1717	ATE	PR 1LB,1LE(288mm disc)1LT,1LF(312mm disc)			
2.4	120	09/01 → 12/04				FCP1491	LUCAS/TRW	
2.4	125	09/01 → 12/04	FCP1717	ATE	PR 1LB,1LE(288mm disc)1LT,1LF(312mm disc)			
2.4	125	09/01 → 12/04				FCP1491	LUCAS/TRW	
2.5 TDI	114	08/01 → 07/02	FCP1717	ATE	PR 1LB,1LE(288mm disc)1LT,1LF(312mm disc)			
2.5 TDI	114	08/01 → 07/02				FCP1491	LUCAS/TRW	
2.5 TDI	120	07/02 → 12/04	FCP1717	ATE	PR 1LB,1LE(288mm disc)1LT,1LF(312mm disc)			
2.5 TDI	120	07/02 → 12/04				FCP1491	LUCAS/TRW	
2.5 TDI quattro	132	11/00 → 12/04	FCP1717	ATE	PR 1LB,1LE(288mm disc)1LT,1LF(312mm disc)			

For material availability see page 16-18 / Per la disponibilità materiali vedere a pagina 16-18



KW



...AUDI

...A4 (8E2, B6)

2.5 TDI quattro	132	11/00 → 12/04
3.0	160	04/01 → 12/04
3.0	160	04/01 → 12/04
3.0 i V6	162	11/00 → 10/04
3.0 i V6	162	11/00 → 12/04
3.0 i V6	162	11/00 → 12/04
3.0 quattro	160	04/01 → 12/04
3.0 quattro	160	04/01 → 12/04
3.0 quattro	162	11/00 → 12/04
3.0 quattro	162	11/00 → 12/04
3.0 quattro	162	11/00 → 12/04

			NOTE
FCP1717	ATE	PR 1LB,1LE(288mm disc)1LT,1LF(312mm disc)	
FCP1323	ATE		
FCP1717	ATE	PR 1LB,1LE(288mm disc)1LT,1LF(312mm disc)	
FCP1717	ATE	PR 1LB,1LE(288mm disc)1LT,1LF(312mm disc)	
FCP1717	ATE	PR 1LB,1LE(288mm disc)1LT,1LF(312mm disc)	
FCP1323	ATE		
FCP1717	ATE	PR 1LB,1LE(288mm disc)1LT,1LF(312mm disc)	

		NOTE
FCP1491	LUCAS/TRW	
FCP1491	LUCAS/TRW	
FCP1491	LUCAS/TRW	
FCP1491	LUCAS/TRW	
FCP1491	LUCAS/TRW	
FCP1491	LUCAS/TRW	
FCP1491	LUCAS/TRW	
FCP1491	LUCAS/TRW	

A4 (8E2, B6) Cabriolet

1.9 TDi	96	11/00 →
1.9 TDi	96	11/00 → 10/04
1.9 TDi	96	11/00 → 12/04
1.9 TDi	96	11/00 → 12/04
2.0 FSi	110	07/02 →
2.0 FSi	110	07/02 → 10/04
2.0 FSi	110	07/02 → 12/04
2.0 FSi	110	07/02 → 12/04
2.0 i	96	11/00 →
2.0 i	96	09/04 → 12/05
2.0 i	96	09/04 → 12/05
2.4 i	125	09/01 →
2.4 i	125	04/02 → 12/05
2.4 i	125	04/02 → 12/05
3.0 i V6	162	11/00 →
3.0 i V6	162	04/02 → 12/05
3.0 i V6	162	04/02 → 12/05
3.0 i V6	162	04/02 → 12/05

FCP1323	ATE		
FCP1323	ATE		
FCP1717	ATE	PR 1LB,1LE(288mm disc)1LT,1LF(312mm disc)	
FCP1491	LUCAS/TRW		
FCP1323	ATE		
FCP1323	ATE		
FCP1717	ATE	PR 1LB,1LE(288mm disc)1LT,1LF(312mm disc)	
FCP1491	LUCAS/TRW		
FCP1717	ATE	PR 1LB,1LE(288mm disc)1LT,1LF(312mm disc)	
FCP1491	LUCAS/TRW		
FCP1323	ATE		
FCP1717	ATE	PR 1LB,1LE(288mm disc)1LT,1LF(312mm disc)	
FCP1491	LUCAS/TRW		
FCP1717	ATE	PR 1LB,1LE(288mm disc)1LT,1LF(312mm disc)	
FCP1491	LUCAS/TRW		
FCP1655	LUCAS/TRW		

A4 (8EC, B7)

1.6	75	11/04 → 06/08
1.6	75	11/04 → 06/08
1.6	75	11/04 → 06/08
1.6	75	11/04 → 06/08
1.8 T	120	11/04 → 06/08
1.8 T	120	11/04 → 06/08
1.8 T	120	11/04 → 06/08
1.8 T	120	11/04 → 06/08
1.8 T quattro	120	11/04 → 06/08
1.8 T quattro	120	11/04 → 06/08
1.8 T quattro	120	11/04 → 06/08
1.8 T quattro	120	11/04 → 06/08
1.9 TDI	85	11/04 → 06/08
1.9 TDI	85	11/04 → 06/08
1.9 TDI	85	11/04 → 06/08
1.9 TDI	85	11/04 → 06/08
2.0	96	11/04 → 06/08
2.0	96	11/04 → 06/08
2.0	96	11/04 → 06/08
2.0	96	11/04 → 06/08
2.0 FSi	110	01/05 → 07/05
2.0 FSi	110	01/05 → 07/05
2.0 FSi	110	01/05 → 07/05
2.0 TDI	100	11/04 → 06/08
2.0 TDI	100	11/04 → 06/08
2.0 TDI	100	11/04 → 06/08
2.0 TDI	100	11/04 → 06/08
2.0 TDI	103	11/04 → 06/08
2.0 TDI	103	11/04 → 06/08
2.0 TDI	103	11/04 → 06/08
2.0 TDI	103	11/04 → 06/08
2.0 TDI	120	06/06 → 06/08
2.0 TDI	120	06/06 → 06/08
2.0 TDI	120	06/06 → 06/08
2.0 TDI	125	06/06 → 06/08
2.0 TDI	125	06/06 → 06/08
2.0 TDI	125	06/06 → 06/08
2.0 TDI	89	09/05 → 09/06
2.0 TDI	89	09/05 → 09/06
2.0 TDI	89	09/05 → 09/06
2.0 TDI 16V	103	11/04 → 06/08
2.0 TDI 16V	103	11/04 → 06/08
2.0 TDI 16V	103	11/04 → 06/08
2.0 TDI quattro	103	01/06 → 06/08

FCP1629	ATE	PR 1LA, 1LC	
FCP1717	ATE	PR 1LB,1LE(288mm disc)1LT,1LF(312mm disc)	
FCP1629	ATE	PR 1LA, 1LC	
FCP1717	ATE	PR 1LB,1LE(288mm disc)1LT,1LF(312mm disc)	
FCP1629	ATE	PR 1LA, 1LC	
FCP1717	ATE	PR 1LB,1LE(288mm disc)1LT,1LF(312mm disc)	
FCP1629	ATE	PR 1LA, 1LC	
FCP1717	ATE	PR 1LB,1LE(288mm disc)1LT,1LF(312mm disc)	
FCP1717	ATE	PR 1LB,1LE(288mm disc)1LT,1LF(312mm disc)	
FCP1629	ATE	PR 1LA, 1LC	
FCP1717	ATE	PR 1LB,1LE(288mm disc)1LT,1LF(312mm disc)	
FCP1629	ATE	PR 1LA, 1LC	
FCP1717	ATE	PR 1LB,1LE(288mm disc)1LT,1LF(312mm disc)	
FCP1629	ATE	PR 1LA, 1LC	
FCP1717	ATE	PR 1LB,1LE(288mm disc)1LT,1LF(312mm disc)	
FCP1629	ATE	PR 1LA, 1LC	
FCP1717	ATE	PR 1LB,1LE(288mm disc)1LT,1LF(312mm disc)	
FCP1717	ATE	PR 1LB,1LE(288mm disc)1LT,1LF(312mm disc)	
FCP1629	ATE	PR 1LA, 1LC	
FCP1717	ATE	PR 1LB,1LE(288mm disc)1LT,1LF(312mm disc)	
FCP1717	ATE	PR 1LB,1LE(288mm disc)1LT,1LF(312mm disc)	
FCP1717	ATE	PR 1LB,1LE(288mm disc)1LT,1LF(312mm disc)	
FCP1717	ATE	PR 1LB,1LE(288mm disc)1LT,1LF(312mm disc)	
FCP1717	ATE	PR 1LB,1LE(288mm disc)1LT,1LF(312mm disc)	
FCP1717	ATE	PR 1LB,1LE(288mm disc)1LT,1LF(312mm disc)	
FCP1717	ATE	PR 1LB,1LE(288mm disc)1LT,1LF(312mm disc)	
FCP1717	ATE	PR 1LB,1LE(288mm disc)1LT,1LF(312mm disc)	
FCP1717	ATE	PR 1LB,1LE(288mm disc)1LT,1LF(312mm disc)	
FCP1717	ATE	PR 1LB,1LE(288mm disc)1LT,1LF(312mm disc)	
FCP1717	ATE	PR 1LB,1LE(288mm disc)1LT,1LF(312mm disc)	
FCP1717	ATE	PR 1LB,1LE(288mm disc)1LT,1LF(312mm disc)	
FCP1717	ATE	PR 1LB,1LE(288mm disc)1LT,1LF(312mm disc)	
FCP1717	ATE	PR 1LB,1LE(288mm disc)1LT,1LF(312mm disc)	

FCP1636	LUCAS/TRW		
FCP1491	LUCAS/TRW		
FCP1636	LUCAS/TRW		
FCP1491	LUCAS/TRW		
FCP1636	LUCAS/TRW		
FCP1491	LUCAS/TRW		
FCP1636	LUCAS/TRW		
FCP1491	LUCAS/TRW		
FCP1636	LUCAS/TRW		
FCP1491	LUCAS/TRW		
FCP1636	LUCAS/TRW		
FCP1491	LUCAS/TRW		
FCP1636	LUCAS/TRW		
FCP1491	LUCAS/TRW		
FCP1636	LUCAS/TRW		
FCP1491	LUCAS/TRW		
FCP1636	LUCAS/TRW		
FCP1491	LUCAS/TRW		
FCP1636	LUCAS/TRW		
FCP1491	LUCAS/TRW		
FCP1636	LUCAS/TRW		
FCP1491	LUCAS/TRW		
FCP1636	LUCAS/TRW		
FCP1491	LUCAS/TRW		
FCP1636	LUCAS/TRW		
FCP1491	LUCAS/TRW		
FCP1636	LUCAS/TRW		
FCP1491	LUCAS/TRW		
FCP1636	LUCAS/TRW		
FCP1491	LUCAS/TRW		
FCP1636	LUCAS/TRW		

For material availability see page 16-18 / Per la disponibilità materiali vedere a pagina 16-18



KW



...AUDI

...A4 (8EC, B7)

			NOTE			NOTE		
2.0 TDI quattro	103	01/06 → 06/08				FCP1491	LUCAS/TRW	
2.0 TDI quattro	103	01/06 → 06/08				FCP1636	LUCAS/TRW	
2.0 TDI quattro	120	06/06 → 06/08	FCP1717	ATE	PR1LB,1LE(288mm disc)1LT,1LF(312mm disc)			
2.0 TDI quattro	120	06/06 → 06/08				FCP1491	LUCAS/TRW	
2.0 TDI quattro	125	06/06 → 06/08	FCP1717	ATE	PR1LB,1LE(288mm disc)1LT,1LF(312mm disc)			
2.0 TDI quattro	125	06/06 → 06/08				FCP1491	LUCAS/TRW	
2.0 TDI quattro	125	06/06 → 06/08				FCP1636	LUCAS/TRW	
2.0 TFSI	125	10/06 → 06/08	FCP1717	ATE	PR1LB,1LE(288mm disc)1LT,1LF(312mm disc)			
2.0 TFSI	125	10/06 → 06/08				FCP1491	LUCAS/TRW	
2.0 TFSI	125	10/06 → 06/08				FCP1636	LUCAS/TRW	
2.0 TFSI	147	11/04 → 06/08	FCP1629	ATE	PR 1LA, 1LC			
2.0 TFSI	147	11/04 → 06/08	FCP1717	ATE	PR1LB,1LE(288mm disc)1LT,1LF(312mm disc)			
2.0 TFSI	147	11/04 → 06/08				FCP1636	LUCAS/TRW	
2.0 TFSI	147	11/04 → 06/08				FCP1491	LUCAS/TRW	
2.0 TFSI	162	06/05 → 06/08	FCP1629	ATE	PR 1LJ/ 1LA/1LC			
2.0 TFSI	162	06/05 → 06/08	FCP1717	ATE	PR1LB,1LE(288mm disc)1LT,1LF(312mm disc)			
2.0 TFSI	162	06/05 → 06/08				FCP1655	LUCAS/TRW	PR 1KE
2.0 TFSI	162	06/05 → 06/08				FCP1491	LUCAS/TRW	
2.0 TFSI	162	06/05 → 06/08				FCP1636	LUCAS/TRW	
2.0 TFSI quattro	147	11/04 → 06/08	FCP1717	ATE	PR1LB,1LE(288mm disc)1LT,1LF(312mm disc)			
2.0 TFSI quattro	147	11/04 → 06/08				FCP1491	LUCAS/TRW	
2.0 TFSI quattro	147	11/04 → 06/08				FCP1636	LUCAS/TRW	
2.0 TFSI quattro	162	06/05 → 06/08	FCP1629	ATE	PR 1LA, 1LC			
2.0 TFSI quattro	162	06/05 → 06/08	FCP1717	ATE	PR1LB,1LE(288mm disc)1LT,1LF(312mm disc)			
2.0 TFSI quattro	162	06/05 → 06/08				FCP1636	LUCAS/TRW	
2.0 TFSI quattro	162	06/05 → 06/08				FCP1491	LUCAS/TRW	
2.0 TFSI quattro	162	06/05 → 06/08				FCP1655	LUCAS/TRW	
2.5 TDI	120	11/04 → 05/06	FCP1629	ATE	PR 1LA, 1LC			
2.5 TDI	120	11/04 → 05/06	FCP1717	ATE	PR1LB,1LE(288mm disc)1LT,1LF(312mm disc)			
2.5 TDI	120	11/04 → 05/06				FCP1636	LUCAS/TRW	
2.5 TDI	120	11/04 → 05/06				FCP1491	LUCAS/TRW	
2.7 TDI	120	11/05 → 06/08	FCP1717	ATE	PR1LB,1LE(288mm disc)1LT,1LF(312mm disc)			
2.7 TDI	120	11/05 → 06/08				FCP1491	LUCAS/TRW	
2.7 TDI	120	11/05 → 06/08				FCP1636	LUCAS/TRW	
2.7 TDI	132	01/06 → 06/08	FCP1717	ATE	PR1LB,1LE(288mm disc)1LT,1LF(312mm disc)			
2.7 TDI	132	01/06 → 06/08				FCP1491	LUCAS/TRW	
2.7 TDI	132	01/06 → 06/08				FCP1636	LUCAS/TRW	
3.0	160	11/04 → 05/06	FCP1717	ATE	PR1LB,1LE(288mm disc)1LT,1LF(312mm disc)			
3.0	160	11/04 → 05/06				FCP1491	LUCAS/TRW	
3.0	160	11/04 → 05/06				FCP1636	LUCAS/TRW	
3.0 quattro	160	11/04 → 07/06	FCP1717	ATE	PR1LB,1LE(288mm disc)1LT,1LF(312mm disc)			
3.0 quattro	160	11/04 → 07/06				FCP1491	LUCAS/TRW	
3.0 quattro	160	11/04 → 07/06				FCP1636	LUCAS/TRW	
3.0 TDI quattro	150	11/04 → 06/08	FCP1629	ATE	PR 1LA, 1LC			
3.0 TDI quattro	150	11/04 → 06/08	FCP1717	ATE	PR1LB,1LE(288mm disc)1LT,1LF(312mm disc)			
3.0 TDI quattro	150	11/04 → 06/08				FCP1636	LUCAS/TRW	
3.0 TDI quattro	150	11/04 → 06/08				FCP1491	LUCAS/TRW	
3.0 TDI quattro	171	01/06 → 06/08	FCP1717	ATE	PR1LB,1LE(288mm disc)1LT,1LF(312mm disc)			
3.0 TDI quattro	171	01/06 → 06/08				FCP1491	LUCAS/TRW	
3.0 TDI quattro	171	01/06 → 06/08				FCP1636	LUCAS/TRW	
3.2 FSI	188	01/05 → 06/08	FCP1629	ATE	PR 1LA, 1LC			
3.2 FSI	188	01/05 → 06/08	FCP1717	ATE	PR1LB,1LE(288mm disc)1LT,1LF(312mm disc)			
3.2 FSI	188	01/05 → 06/08				FCP1636	LUCAS/TRW	
3.2 FSI	188	01/05 → 06/08				FCP1491	LUCAS/TRW	
3.2 FSI quattro	188	01/05 → 06/08	FCP1717	ATE	PR1LB,1LE(288mm disc)1LT,1LF(312mm disc)			
3.2 FSI quattro	188	01/05 → 06/08	FCP1629	ATE	PR 1LA, 1LC			
3.2 FSI quattro	188	01/05 → 06/08				FCP1491	LUCAS/TRW	
3.2 FSI quattro	188	01/05 → 06/08				FCP1636	LUCAS/TRW	
RS4 quattro	309	09/05 → 06/08	FCP1664	BREMBO	PR 1LP			
RS4 quattro	309	09/05 → 06/08	FCP4467	BREMBO	NOT FOR CERAMIC DISCS			
RS4 quattro	309	09/05 → 06/08				FCP1655	LUCAS/TRW	
S4 quattro	253	03/03 → 06/08	FCP1629	ATE	PR 1LJ			
S4 quattro	253	03/03 → 06/08				FCP1655	LUCAS/TRW	

A4 (8K2, B8)

1.8 TFSI	118	11/07 →	FCP4045	ATE				
1.8 TFSI	118	11/07 →				FCP4050	LUCAS/TRW	
1.8 TFSI	88	01/08 →	FCP4045	ATE				
1.8 TFSI	88	01/08 →				FCP4050	LUCAS/TRW	
2.0 TDi	100	11/07 →	FCP4045	ATE				
2.0 TDi	100	11/07 →				FCP4050	LUCAS/TRW	
2.0 TDi	105	11/07 →	FCP4045	ATE				
2.0 TDi	105	11/07 →				FCP4050	LUCAS/TRW	
2.0 TDi	88	06/08 →	FCP4045	ATE				
2.0 TDi	88	06/08 →				FCP4050	LUCAS/TRW	
2.0 Tdi Quattro	125	01/08 →	FCP4044	LUCAS/TRW				
2.0 Tdi Quattro	125	01/08 →				FCP4050	LUCAS/TRW	

For material availability see page 16-18 / Per la disponibilità materiali vedere a pagina 16-18



KW



...AUDI

...A4 (8K2, B8)

					NOTE			NOTE
2.0 TFSI	132	06/08 →	FCP4044	LUCAS/TRW				
2.0 TFSI	132	06/08 →				FCP4050	LUCAS/TRW	
2.0 TFSI	155	06/08 →	FCP4044	LUCAS/TRW				
2.0 TFSI	155	06/08 →				FCP4050	LUCAS/TRW	
2.0 TFSI Quattro	155	06/08 →	FCP4044	LUCAS/TRW				
2.0 TFSI Quattro	155	06/08 →				FCP4050	LUCAS/TRW	
2.7 TDi	140	11/07 →	FCP4044	LUCAS/TRW				
2.7 TDi	140	11/07 →				FCP4050	LUCAS/TRW	
3.0 TDi Quattro	176	11/07 →	FCP4044	LUCAS/TRW				
3.0 TDi Quattro	176	11/07 →				FCP4050	LUCAS/TRW	
3.2 FSI Quattro	195	11/07 →	FCP4044	LUCAS/TRW				
3.2 FSI Quattro	195	11/07 →				FCP4050	LUCAS/TRW	
S4 Quattro	245	11/08 →	FCP4044	LUCAS/TRW				
S4 Quattro	245	11/08 →				FCP4050	LUCAS/TRW	

A4 Allroad (8KH)

2.0 TDi Quattro	125	04/09 →	FCP4044	LUCAS/TRW				
2.0 TDi Quattro	125	04/09 →				FCP4050	LUCAS/TRW	
2.0 TFSI Quattro	155	04/09 →	FCP4044	LUCAS/TRW				
2.0 TFSI Quattro	155	04/09 →				FCP4050	LUCAS/TRW	
3.0 TDi Quattro	176	04/09 →	FCP4044	LUCAS/TRW				
3.0 TDi Quattro	176	04/09 →				FCP4050	LUCAS/TRW	
3.0 TDi Quattro	180	01/12 →	FCP4044	LUCAS/TRW				
3.0 TDi Quattro	180	01/12 →				FCP4050	LUCAS/TRW	

A4 Avant (8D5, B5)

1.6	74	11/94 → 09/97	FCP775	LUCAS/TRW				
1.6	74	11/94 → 09/97	FCP590	ATE				
1.6	74	11/94 → 09/97				FCP596	LUCAS/TRW	
1.6	74	10/97 → 11/00	FCP1289	LUCAS/TRW				
1.6	74	10/97 →	FCP590	ATE				
1.6	74	10/97 →	FCP1289	LUCAS/TRW				
1.6	74	10/97 → 11/00				FCP541	LUCAS/TRW	
1.6 i	75	11/00 →	FCP1289	LUCAS/TRW				
1.6 i	75	11/00 →				FCP541	LUCAS/TRW	
1.8 20V	110	11/94 → 09/97	FCP775	LUCAS/TRW				
1.8 20V	110	11/94 → 09/97	FCP590	ATE				
1.8 20V	110	11/94 → 09/97				FCP596	LUCAS/TRW	
1.8 20V	85, 132	10/97 →	FCP1289	LUCAS/TRW				
1.8 20V	85, 132	10/97 →	FCP590	ATE				
1.8 20V	85, 132	10/97 →				FCP541	LUCAS/TRW	
1.8 i Turbo 20V	110	11/00 → 10/04	FCP1323	ATE				
1.8 i Turbo 20V	110	11/00 → 07/02	FCP1717	ATE	PR 1LB,1LE(288mm disc)1LT,1LF(312mm disc)			
1.8 i Turbo 20V	110	11/00 → 10/04				FCP541	LUCAS/TRW	
1.8 i Turbo 20V	110	11/00 → 07/02				FCP1491	LUCAS/TRW	
1.8 i Turbo A 20V	110, 132	11/94 → 07/97	FCP1323	ATE				
1.8 quattro	92	01/96 → 02/99	FCP775	LUCAS/TRW				
1.8 quattro	92	01/96 → 02/99	FCP1289	LUCAS/TRW				
1.8 T	132	12/97 → 09/01	FCP1323	ATE				
1.8 T quattro	110	01/96 → 09/01	FCP1323	ATE				
1.8 T quattro	132	03/99 → 09/01	FCP1323	ATE				
1.8 Turbo 20V	110, 132	11/94 → 07/97	FCP590	ATE				
1.8 Turbo 20V	110, 132	11/94 → 07/97				FCP596	LUCAS/TRW	
1.9 TDi	66, 81	11/94 → 09/97	FCP775	LUCAS/TRW				
1.9 TDi	66, 81	11/94 → 09/97	FCP590	ATE				
1.9 TDi	66, 81	11/94 → 09/97				FCP596	LUCAS/TRW	
1.9 TDi	66, 81	10/97 → 11/00	FCP1289	LUCAS/TRW				
1.9 TDi	66, 81	10/97 → 11/00	FCP1323	ATE				
1.9 TDi	66, 81	10/97 → 11/00				FCP541	LUCAS/TRW	
1.9 Tdi quattro	85	03/00 → 09/01	FCP775	LUCAS/TRW				
1.9 Tdi quattro	96	03/99 → 09/01	FCP1323	ATE				
2.4	120	03/99 → 09/01	FCP1323	ATE				
2.4 30V	121	01/97 → 11/00	FCP590	ATE				
2.4 30V	121	01/97 → 11/00				FCP541	LUCAS/TRW	
2.4 quattro	121	03/97 → 02/99	FCP590	ATE				
2.4 quattro	121	03/97 → 02/99				FCP541	LUCAS/TRW	
2.4 quattro	120	08/97 → 09/01	FCP1323	ATE				
2.5 TDi 24V	110	01/97 → 11/00	FCP590	ATE				
2.5 TDi 24V	110	01/97 → 11/00				FCP541	LUCAS/TRW	
2.5 TDi quattro	110	01/97 → 02/99	FCP590	ATE				
2.5 TDi quattro	110	01/97 → 02/99				FCP541	LUCAS/TRW	
2.6	110	11/94 → 11/00	FCP590	ATE				
2.6	110	11/94 → 11/00				FCP596	LUCAS/TRW	
2.6 quattro	110	01/96 → 09/01	FCP590	ATE				
2.6 quattro	110	01/96 → 09/01				FCP596	LUCAS/TRW	
2.8	140	03/99 → 09/00	FCP1323	ATE				
2.8 30V	142	11/94 → 11/00	FCP590	ATE				

For material availability see page 16-18 / Per la disponibilità materiali vedere a pagina 16-18



KW



...AUDI			NOTE			NOTE		
...A4 Avant (8D5, B5)								
2.8 30V	142	11/94 → 11/00	FCP1323	ATE		FCP596	LUCAS/TRW	
2.8 quattro	140	03/99 → 09/00	FCP590	ATE				
2.8 quattro	128	01/96 → 09/96				FCP596	LUCAS/TRW	
2.8 quattro	128	01/96 → 09/96						
2.8 quattro	142	10/96 → 02/99	FCP590	ATE				
2.8 quattro	142	10/96 → 02/99				FCP596	LUCAS/TRW	
RS4 quattro	280	05/00 → 09/01	FCP1001	ATE				
RS4 quattro	280	05/00 → 09/01				FCP1491	LUCAS/TRW	
S4 quattro	195	09/97 → 09/01	FCP1629	ATE				
S4 quattro	195	09/97 → 09/01				FCP1491	LUCAS/TRW	
A4 Avant (8E5, B6)								
1.6	75	09/01 → 12/04	FCP1717	ATE	PR 1LB,1LE(288mm disc)1LT,1LF(312mm disc)			
1.6	75	09/01 → 12/04				FCP1491	LUCAS/TRW	
1.8 T	110	09/01 → 07/02	FCP1717	ATE	PR 1LB,1LE(288mm disc)1LT,1LF(312mm disc)			
1.8 T	110	09/01 → 07/02				FCP1491	LUCAS/TRW	
1.8 T	120	07/02 → 12/04	FCP1717	ATE	PR 1LB,1LE(288mm disc)1LT,1LF(312mm disc)			
1.8 T	120	07/02 → 12/04				FCP1491	LUCAS/TRW	
1.8 T	140	11/02 → 12/04	FCP1717	ATE	PR 1LB,1LE(288mm disc)1LT,1LF(312mm disc)			
1.8 T	140	11/02 → 12/04				FCP1491	LUCAS/TRW	
1.8 T quattro	110	09/01 → 07/02	FCP1717	ATE	PR 1LB,1LE(288mm disc)1LT,1LF(312mm disc)			
1.8 T quattro	110	09/01 → 07/02				FCP1491	LUCAS/TRW	
1.8 T quattro	120	07/02 → 12/04	FCP1717	ATE	PR 1LB,1LE(288mm disc)1LT,1LF(312mm disc)			
1.8 T quattro	120	07/02 → 12/04				FCP1491	LUCAS/TRW	
1.8 T quattro	125	09/01 → 12/04	FCP1717	ATE	PR 1LB,1LE(288mm disc)1LT,1LF(312mm disc)			
1.8 T quattro	125	09/01 → 12/04				FCP1491	LUCAS/TRW	
1.8 T quattro	140	11/02 → 12/04	FCP1717	ATE	PR 1LB,1LE(288mm disc)1LT,1LF(312mm disc)			
1.8 T quattro	140	11/02 → 12/04				FCP1491	LUCAS/TRW	
1.9 TDI	74	11/01 → 12/04	FCP1717	ATE	PR 1LB,1LE(288mm disc)1LT,1LF(312mm disc)			
1.9 TDI	74	11/01 → 12/04				FCP1491	LUCAS/TRW	
1.9 TDI	96	11/00 → 10/04	FCP1323	ATE				
1.9 TDI	96	09/01 → 12/04	FCP1717	ATE	PR 1LB,1LE(288mm disc)1LT,1LF(312mm disc)			
1.9 TDI	96	09/01 → 12/04				FCP1491	LUCAS/TRW	
1.9 TDI quattro	96	11/01 → 12/04	FCP1717	ATE	PR 1LB,1LE(288mm disc)1LT,1LF(312mm disc)			
1.9 TDI quattro	96	11/01 → 12/04				FCP1491	LUCAS/TRW	
2.0	96	11/00 → 10/04	FCP1323	ATE				
2.0	96	09/01 → 12/04	FCP1717	ATE	PR 1LB,1LE(288mm disc)1LT,1LF(312mm disc)			
2.0	96	09/01 → 12/04				FCP1491	LUCAS/TRW	
2.0 FSI	110	07/02 → 12/04	FCP1717	ATE	PR 1LB,1LE(288mm disc)1LT,1LF(312mm disc)			
2.0 FSI	110	07/02 → 12/04				FCP1491	LUCAS/TRW	
2.4	120	09/01 → 12/04	FCP1717	ATE	PR 1LB,1LE(288mm disc)1LT,1LF(312mm disc)			
2.4	120	09/01 → 12/04				FCP1491	LUCAS/TRW	
2.4	125	09/01 → 12/04	FCP1717	ATE	PR 1LB,1LE(288mm disc)1LT,1LF(312mm disc)			
2.4	125	09/01 → 12/04				FCP1491	LUCAS/TRW	
2.4	125	09/01 → 12/04	FCP1717	ATE	PR 1LB,1LE(288mm disc)1LT,1LF(312mm disc)			
2.4	125	09/01 → 12/04				FCP1491	LUCAS/TRW	
2.5 TDI	114	09/01 → 07/02	FCP1717	ATE	PR 1LB,1LE(288mm disc)1LT,1LF(312mm disc)			
2.5 TDI	114	09/01 → 07/02				FCP1491	LUCAS/TRW	
2.5 TDI	120	07/02 → 12/04	FCP1717	ATE	PR 1LB,1LE(288mm disc)1LT,1LF(312mm disc)			
2.5 TDI	120	07/02 → 12/04				FCP1491	LUCAS/TRW	
2.5 TDI quattro	132	09/01 → 12/04	FCP1717	ATE	PR 1LB,1LE(288mm disc)1LT,1LF(312mm disc)			
2.5 TDI quattro	132	09/01 → 12/04				FCP1491	LUCAS/TRW	
3.0	160	04/01 → 12/04	FCP1717	ATE	PR 1LB,1LE(288mm disc)1LT,1LF(312mm disc)			
3.0	160	04/01 → 12/04				FCP1491	LUCAS/TRW	
3.0	162	11/00 → 10/04	FCP1323	ATE				
3.0	162	09/01 → 12/04	FCP1717	ATE	PR 1LB,1LE(288mm disc)1LT,1LF(312mm disc)			
3.0	162	09/01 → 12/04				FCP1491	LUCAS/TRW	
3.0 quattro	160	04/01 → 12/04	FCP1717	ATE	PR 1LB,1LE(288mm disc)1LT,1LF(312mm disc)			
3.0 quattro	160	04/01 → 12/04				FCP1491	LUCAS/TRW	
3.0 quattro	162	09/01 → 12/04	FCP1717	ATE	PR 1LB,1LE(288mm disc)1LT,1LF(312mm disc)			
3.0 quattro	162	09/01 → 12/04				FCP1491	LUCAS/TRW	
S4 quattro	253	03/03 → 12/04	FCP1629	ATE				
S4 quattro	253	03/03 → 06/08	FCP1629	ATE	PR 1LJ			
S4 quattro	253	03/03 → 06/08				FCP1655	LUCAS/TRW	
A4 Avant (8ED, B7)								
1.6	75	11/04 → 06/08	FCP1629	ATE	PR 1LA, 1LC			
1.6	75	11/04 → 06/08	FCP1717	ATE	PR1LB,1LE(288mm disc)1LT,1LF(312mm disc)			
1.6	75	11/04 → 06/08				FCP1636	LUCAS/TRW	
1.6	75	11/04 → 06/08				FCP1491	LUCAS/TRW	
1.8 T	120	11/04 → 06/08	FCP1629	ATE	PR 1LA, 1LC			
1.8 T	120	11/04 → 06/08	FCP1717	ATE	PR1LB,1LE(288mm disc)1LT,1LF(312mm disc)			
1.8 T	120	11/04 → 06/08				FCP1636	LUCAS/TRW	
1.8 T	120	11/04 → 06/08				FCP1491	LUCAS/TRW	
1.8 T quattro	120	11/04 → 06/08	FCP1717	ATE	PR1LB,1LE(288mm disc)1LT,1LF(312mm disc)			
1.8 T quattro	120	11/04 → 06/08	FCP1629	ATE	PR 1LA, 1LC			
1.8 T quattro	120	11/04 → 06/08				FCP1491	LUCAS/TRW	
1.8 T quattro	120	11/04 → 06/08				FCP1636	LUCAS/TRW	
1.9 TDI	85	11/04 → 06/08	FCP1629	ATE	PR 1LA, 1LC			

AUDI

For material availability see page 16-18 / Per la disponibilità materiali vedere a pagina 16-18



KW



...AUDI

...A4 Avant (8ED, B7)

			NOTE			NOTE		
1.9 TDI	85	11/04 → 06/08	FCP1717	ATE	PR1LB,1LE(288mm disc)1LT,1LF(312mm disc)	FCP1636	LUCAS/TRW	
1.9 TDI	85	11/04 → 06/08				FCP1491	LUCAS/TRW	
1.9 TDI	85	11/04 → 06/08						
2.0	96	11/04 → 06/08	FCP1717	ATE	PR1LB,1LE(288mm disc)1LT,1LF(312mm disc)	FCP1491	LUCAS/TRW	
2.0	96	11/04 → 06/08				FCP1636	LUCAS/TRW	
2.0	96	11/04 → 06/08						
2.0 TDI	100	11/04 → 06/08	FCP1717	ATE	PR1LB,1LE(288mm disc)1LT,1LF(312mm disc)	FCP1491	LUCAS/TRW	
2.0 TDI	100	11/04 → 06/08				FCP1636	LUCAS/TRW	
2.0 TDI	100	11/04 → 06/08						
2.0 TDI	103	11/04 → 06/08	FCP1629	ATE	PR 1LA, 1LC			
2.0 TDI	103	11/04 → 06/08	FCP1717	ATE	PR1LB,1LE(288mm disc)1LT,1LF(312mm disc)			
2.0 TDI	103	11/04 → 06/08				FCP1636	LUCAS/TRW	
2.0 TDI	103	11/04 → 06/08				FCP1491	LUCAS/TRW	
2.0 TDI	120	06/06 → 06/08	FCP1717	ATE	PR1LB,1LE(288mm disc)1LT,1LF(312mm disc)			
2.0 TDI	120	06/06 → 06/08				FCP1491	LUCAS/TRW	
2.0 TDI	120	06/06 → 06/08				FCP1636	LUCAS/TRW	
2.0 TDI	125	06/06 → 06/08	FCP1717	ATE	PR1LB,1LE(288mm disc)1LT,1LF(312mm disc)			
2.0 TDI	125	06/06 → 06/08				FCP1491	LUCAS/TRW	
2.0 TDI	125	06/06 → 06/08				FCP1636	LUCAS/TRW	
2.0 TDI	89	09/05 → 09/06	FCP1717	ATE	PR1LB,1LE(288mm disc)1LT,1LF(312mm disc)			
2.0 TDI	89	09/05 → 09/06				FCP1491	LUCAS/TRW	
2.0 TDI	89	09/05 → 09/06				FCP1636	LUCAS/TRW	
2.0 TDI 16V	103	11/04 → 06/08	FCP1717	ATE	PR1LB,1LE(288mm disc)1LT,1LF(312mm disc)			
2.0 TDI 16V	103	11/04 → 06/08				FCP1491	LUCAS/TRW	
2.0 TDI 16V	103	11/04 → 06/08				FCP1636	LUCAS/TRW	
2.0 TDI quattro	103	01/06 → 06/08	FCP1717	ATE	PR1LB,1LE(288mm disc)1LT,1LF(312mm disc)			
2.0 TDI quattro	103	01/06 → 06/08				FCP1491	LUCAS/TRW	
2.0 TDI quattro	103	01/06 → 06/08				FCP1636	LUCAS/TRW	
2.0 TDI quattro	120	06/06 → 06/08	FCP1717	ATE	PR1LB,1LE(288mm disc)1LT,1LF(312mm disc)			
2.0 TDI quattro	120	06/06 → 06/08				FCP1491	LUCAS/TRW	
2.0 TDI quattro	120	06/06 → 06/08				FCP1636	LUCAS/TRW	
2.0 TDI quattro	125	06/06 → 06/08	FCP1717	ATE	PR1LB,1LE(288mm disc)1LT,1LF(312mm disc)			
2.0 TDI quattro	125	06/06 → 06/08				FCP1491	LUCAS/TRW	
2.0 TDI quattro	125	06/06 → 06/08				FCP1636	LUCAS/TRW	
2.0 TFSI	125	10/06 → 06/08	FCP1717	ATE	PR1LB,1LE(288mm disc)1LT,1LF(312mm disc)			
2.0 TFSI	125	10/06 → 06/08				FCP1491	LUCAS/TRW	
2.0 TFSI	125	10/06 → 06/08				FCP1636	LUCAS/TRW	
2.0 TFSI	147	11/04 → 06/08	FCP1629	ATE	PR 1LA, 1LC			
2.0 TFSI	147	11/04 → 06/08	FCP1717	ATE	PR1LB,1LE(288mm disc)1LT,1LF(312mm disc)			
2.0 TFSI	147	11/04 → 06/08				FCP1636	LUCAS/TRW	
2.0 TFSI	147	11/04 → 06/08				FCP1491	LUCAS/TRW	
2.0 TFSI	162	06/05 → 10/07	FCP1629	ATE	PR 1LJ/ 1LA/1LC			
2.0 TFSI	162	06/05 → 06/08	FCP1717	ATE	PR1LB,1LE(288mm disc)1LT,1LF(312mm disc)			
2.0 TFSI	162	06/05 → 10/07				FCP1655	LUCAS/TRW	PR 1KE
2.0 TFSI	162	06/05 → 06/08				FCP1491	LUCAS/TRW	
2.0 TFSI	162	06/05 → 06/08				FCP1636	LUCAS/TRW	
2.0 TFSI quattro	147	11/04 → 06/08	FCP1629	ATE	PR 1LA, 1LC			
2.0 TFSI quattro	147	11/04 → 06/08	FCP1717	ATE	PR1LB,1LE(288mm disc)1LT,1LF(312mm disc)			
2.0 TFSI quattro	147	11/04 → 06/08				FCP1636	LUCAS/TRW	
2.0 TFSI quattro	147	11/04 → 06/08				FCP1491	LUCAS/TRW	
2.0 TFSI quattro	162	06/05 → 06/08	FCP1717	ATE	PR1LB,1LE(288mm disc)1LT,1LF(312mm disc)			
2.0 TFSI quattro	162	06/05 → 06/08				FCP1491	LUCAS/TRW	
2.0 TFSI quattro	162	06/05 → 06/08				FCP1636	LUCAS/TRW	
2.5 TDI	120	11/04 → 05/06	FCP1629	ATE	PR 1LA, 1LC			
2.5 TDI	120	11/04 → 05/06	FCP1717	ATE	PR1LB,1LE(288mm disc)1LT,1LF(312mm disc)			
2.5 TDI	120	11/04 → 05/06				FCP1636	LUCAS/TRW	
2.5 TDI	120	11/04 → 05/06				FCP1491	LUCAS/TRW	
2.7 TDI	120	11/05 → 03/08	FCP1717	ATE	PR1LB,1LE(288mm disc)1LT,1LF(312mm disc)			
2.7 TDI	120	11/05 → 03/08				FCP1491	LUCAS/TRW	
2.7 TDI	120	11/05 → 03/08				FCP1636	LUCAS/TRW	
2.7 TDI	132	01/06 → 06/08	FCP1717	ATE	PR1LB,1LE(288mm disc)1LT,1LF(312mm disc)			
2.7 TDI	132	01/06 → 06/08				FCP1491	LUCAS/TRW	
2.7 TDI	132	01/06 → 06/08				FCP1636	LUCAS/TRW	
3.0	160	11/04 → 05/06	FCP1717	ATE	PR1LB,1LE(288mm disc)1LT,1LF(312mm disc)			
3.0	160	11/04 → 05/06				FCP1491	LUCAS/TRW	
3.0	160	11/04 → 05/06				FCP1636	LUCAS/TRW	
3.0 quattro	160	11/04 → 07/06	FCP1717	ATE	PR1LB,1LE(288mm disc)1LT,1LF(312mm disc)			
3.0 quattro	160	11/04 → 07/06				FCP1491	LUCAS/TRW	
3.0 quattro	160	11/04 → 07/06				FCP1636	LUCAS/TRW	
3.0 TDI quattro	150	11/04 → 06/08	FCP1629	ATE	PR 1LA, 1LC			
3.0 TDI quattro	150	11/04 → 06/08	FCP1717	ATE	PR1LB,1LE(288mm disc)1LT,1LF(312mm disc)			
3.0 TDI quattro	150	11/04 → 06/08				FCP1636	LUCAS/TRW	
3.0 TDI quattro	150	11/04 → 06/08				FCP1491	LUCAS/TRW	
3.0 TDI quattro	171	01/06 → 06/08	FCP1717	ATE	PR1LB,1LE(288mm disc)1LT,1LF(312mm disc)			
3.0 TDI quattro	171	01/06 → 06/08				FCP1491	LUCAS/TRW	
3.0 TDI quattro	171	01/06 → 06/08				FCP1636	LUCAS/TRW	
3.2 FSI	188	01/05 → 06/08	FCP1629	ATE	PR 1LA, 1LC			
3.2 FSI	188	01/05 → 06/08	FCP1717	ATE	PR1LB,1LE(288mm disc)1LT,1LF(312mm disc)			

For material availability see page 16-18 / Per la disponibilità materiali vedere a pagina 16-18



KW



...AUDI

NOTE

NOTE

...A4 Convertible (8H7, B6, 8HE, B7)

3.2 FSI	188	01/06 → 03/09					FCP1655	LUCAS/TRW	
3.2 FSI	188	01/06 → 03/09					FCP1491	LUCAS/TRW	
3.2 FSI	188	01/06 → 03/09					FCP1655	LUCAS/TRW	
3.2 FSI quattro	188	01/06 → 03/09	FCP1717	ATE	PR1LB,1LE(288mm disc)1LT,1LF(312mm disc)				
3.2 FSI quattro	188	01/06 → 03/09					FCP1491	LUCAS/TRW	
3.2 FSI quattro	188	01/06 → 03/09					FCP1655	LUCAS/TRW	
RS4 quattro	309	06/06 → 03/09	FCP1664	BREMBO	PR 1LP				
RS4 quattro	309	06/06 → 03/09	FCP4467	BREMBO	NOT FOR CERAMIC DISCS				
RS4 quattro	309	06/06 → 03/09					FCP1655	LUCAS/TRW	
S4 quattro	253	03/04 → 03/09	FCP1629	ATE	PR 1LJ				
S4 quattro	253	03/04 → 03/09					FCP1655	LUCAS/TRW	PR 1KE

A5 (8T3)

1.8 TFSI	125	10/07 →	FCP4045	ATE					
1.8 TFSI	125	10/07 →					FCP4050	LUCAS/TRW	
2.0 TFSI	132	11/08 →	FCP4044	LUCAS/TRW					
2.0 TFSI	132	11/08 →					FCP4050	LUCAS/TRW	
2.0 TSFI Quattro	155	06/08 →	FCP4044	LUCAS/TRW					
2.0 TSFI Quattro	155	06/08 →					FCP4050	LUCAS/TRW	
2.7 TDi	140	06/07 →	FCP4044	LUCAS/TRW					
2.7 TDi	140	06/07 →					FCP4050	LUCAS/TRW	
3.0 TDi Quattro	176	06/07 →	FCP4044	LUCAS/TRW					
3.0 TDi Quattro	176	06/07 →					FCP4050	LUCAS/TRW	
3.2 FSI	195	06/07 →	FCP4044	LUCAS/TRW					
3.2 FSI	195	06/07 →					FCP4050	LUCAS/TRW	
3.2 FSI Quattro	195	06/07 →	FCP4044	LUCAS/TRW					
3.2 FSI Quattro	195	06/07 →					FCP4050	LUCAS/TRW	
RS5 quattro	331	03/10 →	FCP1664	BREMBO	PR 1LM				
RS5 quattro	331	03/10 →	FCP4467	BREMBO	NOT FOR CERAMIC DISCS				
RS5 quattro	331	03/10 →					FCP1655	LUCAS/TRW	
S5 quattro	260	06/07 →	FCP4044	LUCAS/TRW	320mm				
S5 quattro	260	06/07 →					FCP4050	LUCAS/TRW	

A5 Convertible (8F7)

RS5 quattro	331	02/13 →	FCP1664	Brembo					
RS5 quattro	331	02/13 →	FCP4467	BREMBO	NOT FOR CERAMIC DISCS				

A6 (4A, C4)

1.8 20V	92	12/95 → 02/97	FCP590	ATE					
1.8 20V	92	12/95 → 02/97					FCP596	LUCAS/TRW	
1.8 20V quattro	92	12/95 → 02/97	FCP590	ATE					
1.8 20V quattro	92	12/95 → 02/97					FCP596	LUCAS/TRW	
1.9 TDi	66	06/94 → 02/97	FCP590	ATE					
1.9 TDi	66	06/94 → 02/97					FCP596	LUCAS/TRW	
2.0 16V	103	06/94 → 02/97	FCP590	ATE					
2.0 16V	103	06/94 → 02/97					FCP596	LUCAS/TRW	
2.0 16V quattro	103	06/94 → 02/97	FCP590	ATE					
2.0 16V quattro	103	06/94 → 02/97					FCP596	LUCAS/TRW	
2.3 quattro	98	06/94 → 12/97	FCP590	ATE					
2.3 quattro	98	06/94 → 12/97					FCP596	LUCAS/TRW	
2.4 30V quattro	121	03/97 → 04/04	FCP1323	ATE					
2.4 30V quattro	121	03/97 → 04/04					FCP541	LUCAS/TRW	
2.5 TDi quattro	103	06/94 → 12/97	FCP590	ATE					
2.5 TDi quattro	103	06/94 → 12/97					FCP596	LUCAS/TRW	
2.6 quattro	110	06/94 → 02/97	FCP590	ATE					
2.6 quattro	110	06/94 → 02/97					FCP596	LUCAS/TRW	
2.8 30V quattro	142	06/94 → 02/97	FCP590	ATE					
2.8 30V quattro	142	06/94 → 02/97					FCP596	LUCAS/TRW	
S6 4.2 quattro	213	06/94 → 10/97					FCP596	LUCAS/TRW	
S6 Plus quattro	240	04/94 → 10/97					FCP596	LUCAS/TRW	

A6 (4B2, C5)

1.8	92	07/97 → 01/05	FCP1717	ATE	PR 1LB,1LE-1LF,1LT(288-312disc)da ch.4B-X-070001				
1.8	92	07/97 → 01/05					FCP1491	LUCAS/TRW	
1.8 i Turbo 20V	110	01/97 → 03/04	FCP1323	ATE					
1.8 i Turbo 20V	132	01/97 → 03/04	FCP1323	ATE					
1.8 T	110	01/97 → 01/05	FCP1717	ATE	PR 1LB,1LE-1LF,1LT(288-312disc)da ch.4B-X-070001				
1.8 T	110	01/97 → 01/05					FCP1491	LUCAS/TRW	
1.8 T	132	12/97 → 01/05	FCP1717	ATE	PR 1LB,1LE-1LF,1LT(288-312disc)da ch.4B-X-070001				
1.8 T	132	12/97 → 01/05					FCP1491	LUCAS/TRW	
1.8 T quattro	110	02/97 → 01/05	FCP1717	ATE	PR 1LB,1LE-1LF,1LT(288-312disc)da ch.4B-X-070001				
1.8 T quattro	110	02/97 → 01/05					FCP1491	LUCAS/TRW	
1.8 T quattro	132	12/97 → 01/05	FCP1717	ATE	PR 1LB,1LE-1LF,1LT(288-312disc)da ch.4B-X-070001				
1.8 T quattro	132	12/97 → 01/05					FCP1491	LUCAS/TRW	
1.9 TDi	81	04/97 → 10/00	FCP1717	ATE	PR 1LB,1LE-1LF,1LT(288-312disc)da ch.4B-X-070001				
1.9 TDi	81	04/97 → 10/00					FCP1491	LUCAS/TRW	
1.9 TDi	85	07/00 → 01/05	FCP1717	ATE	PR 1LB,1LE-1LF,1LT(288-312disc)da ch.4B-X-070001				

For material availability see page 16-18 / Per la disponibilità materiali vedere a pagina 16-18

1030

FERODO

RACING

Updated on 17th Aug 2018



KW



...AUDI

...A6 (4B2, C5)

				NOTE			NOTE
1.9 TDI	85	07/00	→ 01/05	FCP1717	ATE	PR 1LB,1LE-1LF,1LT(288-312disc)da ch.4B-X-070001	FCP1491 LUCAS/TRW
1.9 TDI	96	08/01	→ 01/05	FCP1717	ATE		FCP1491 LUCAS/TRW
1.9 TDI	96	08/01	→ 01/05	FCP1717	ATE		FCP1491 LUCAS/TRW
1.9 TDi	81	03/97	→ 03/04	FCP1323	ATE		
1.9 TDi	81	12/97	→ 04/04	FCP1323	ATE		
2.0	96	08/01	→ 01/05	FCP1717	ATE	PR 1LB,1LE-1LF,1LT(288-312disc)da ch.4B-X-070001	FCP1491 LUCAS/TRW
2.0	96	08/01	→ 01/05	FCP1717	ATE		FCP1491 LUCAS/TRW
2.0 i	103	03/97	→ 03/04	FCP1323	ATE		
2.0 i	96	03/97	→ 03/04	FCP1323	ATE		
2.0 i	96	08/01	→ 04/04	FCP1323	ATE		
2.4	100	07/98	→ 01/05	FCP1717	ATE	PR 1LB,1LE-1LF,1LT(288-312disc)da ch.4B-X-070001	FCP1491 LUCAS/TRW
2.4	100	07/98	→ 01/05	FCP1717	ATE		FCP1491 LUCAS/TRW
2.4	115	02/97	→ 01/05	FCP1717	ATE	PR 1LB,1LE-1LF,1LT(288-312disc)da ch.4B-X-070001	FCP1491 LUCAS/TRW
2.4	115	02/97	→ 01/05	FCP1717	ATE		FCP1491 LUCAS/TRW
2.4	120	02/97	→ 01/05	FCP1717	ATE	PR 1LB,1LE-1LF,1LT(288-312disc)da ch.4B-X-070001	FCP1491 LUCAS/TRW
2.4	120	02/97	→ 01/05	FCP1717	ATE		FCP1491 LUCAS/TRW
2.4	121	02/97	→ 01/05	FCP1717	ATE	PR 1LB,1LE-1LF,1LT(288-312disc)da ch.4B-X-070001	FCP1491 LUCAS/TRW
2.4	121	02/97	→ 01/05	FCP1717	ATE		FCP1491 LUCAS/TRW
2.4	125	08/01	→ 01/05	FCP1717	ATE	PR 1LB,1LE-1LF,1LT(288-312disc)da ch.4B-X-070001	FCP1491 LUCAS/TRW
2.4	125	08/01	→ 01/05	FCP1717	ATE		FCP1491 LUCAS/TRW
2.4 30V	100	05/97	→ 03/04	FCP1323	ATE		
2.4 30V	100	05/97	→ 03/04	FCP1323	ATE		FCP541 LUCAS/TRW
2.4 30V	120	05/97	→ 03/04	FCP1323	ATE		
2.4 30V	120	05/97	→ 03/04	FCP1323	ATE		FCP541 LUCAS/TRW
2.4 30V	121	05/97	→ 03/04	FCP1323	ATE		
2.4 30V	121	05/97	→ 03/04	FCP1323	ATE		FCP541 LUCAS/TRW
2.4 quattro	115	08/98	→ 07/99	FCP1717	ATE	PR 1LB,1LE-1LF,1LT(288-312disc)da ch.4B-X-070001	FCP1491 LUCAS/TRW
2.4 quattro	115	08/98	→ 07/99	FCP1717	ATE		FCP1491 LUCAS/TRW
2.4 quattro	120	02/97	→ 01/05	FCP1717	ATE	PR 1LB,1LE-1LF,1LT(288-312disc)da ch.4B-X-070001	FCP1491 LUCAS/TRW
2.4 quattro	120	02/97	→ 01/05	FCP1717	ATE		FCP1491 LUCAS/TRW
2.4 quattro	121	02/97	→ 01/05	FCP1717	ATE	PR 1LB,1LE-1LF,1LT(288-312disc)da ch.4B-X-070001	FCP1491 LUCAS/TRW
2.4 quattro	121	02/97	→ 01/05	FCP1717	ATE		FCP1491 LUCAS/TRW
2.4 quattro	125	08/01	→ 01/05	FCP1717	ATE	PR 1LB,1LE-1LF,1LT(288-312disc)da ch.4B-X-070001	FCP1491 LUCAS/TRW
2.4 quattro	125	08/01	→ 01/05	FCP1717	ATE		FCP1491 LUCAS/TRW
2.5 TDi	85	04/97	→ 03/04	FCP1323	ATE		
2.5 TDi	110	07/97	→ 01/05	FCP1717	ATE	PR 1LB,1LE-1LF,1LT(288-312disc)da ch.4B-X-070001	FCP1491 LUCAS/TRW
2.5 TDi	110	07/97	→ 01/05	FCP1717	ATE		FCP1491 LUCAS/TRW
2.5 TDi	114	08/01	→ 01/05	FCP1717	ATE	PR 1LB,1LE-1LF,1LT(288-312disc)da ch.4B-X-070001	FCP1491 LUCAS/TRW
2.5 TDi	114	08/01	→ 01/05	FCP1717	ATE		FCP1491 LUCAS/TRW
2.5 TDi	120	07/02	→ 01/05	FCP1717	ATE	PR 1LB,1LE-1LF,1LT(288-312disc)da ch.4B-X-070001	FCP1491 LUCAS/TRW
2.5 TDi	120	07/02	→ 01/05	FCP1717	ATE		FCP1491 LUCAS/TRW
2.5 TDi	132	02/00	→ 01/05	FCP1717	ATE	PR 1LB,1LE-1LF,1LT(288-312disc)da ch.4B-X-070001	FCP1491 LUCAS/TRW
2.5 TDi	132	02/00	→ 01/05	FCP1717	ATE		FCP1491 LUCAS/TRW
2.5 TDi	85	12/97	→ 04/04	FCP1323	ATE		
2.5 TDi quattro	110	07/97	→ 01/05	FCP1717	ATE	PR 1LB,1LE-1LF,1LT(288-312disc)da ch.4B-X-070001	FCP1491 LUCAS/TRW
2.5 TDi quattro	110	07/97	→ 01/05	FCP1717	ATE		FCP1491 LUCAS/TRW
2.5 TDi quattro	132	02/00	→ 01/05	FCP1717	ATE	PR 1LB,1LE-1LF,1LT(288-312disc)da ch.4B-X-070001	FCP1491 LUCAS/TRW
2.5 TDi quattro	132	02/00	→ 01/05	FCP1717	ATE		FCP1491 LUCAS/TRW
2.8	132	10/97	→ 05/00	FCP1717	ATE	PR 1LB,1LE-1LF,1LT(288-312disc)da ch.4B-X-070001	FCP1491 LUCAS/TRW
2.8	132	10/97	→ 05/00	FCP1717	ATE		FCP1491 LUCAS/TRW
2.8	140	07/99	→ 01/05	FCP1717	ATE	PR 1LB,1LE-1LF,1LT(288-312disc)da ch.4B-X-070001	FCP1491 LUCAS/TRW
2.8	140	07/99	→ 01/05	FCP1717	ATE		FCP1491 LUCAS/TRW
2.8	142	02/97	→ 01/05	FCP1717	ATE	PR 1LB,1LE-1LF,1LT(288-312disc)da ch.4B-X-070001	FCP1491 LUCAS/TRW
2.8	142	02/97	→ 01/05	FCP1717	ATE		FCP1491 LUCAS/TRW
2.8 i	142	03/97	→ 03/04	FCP1323	ATE		
2.8 quattro	142	02/97	→ 01/05	FCP1717	ATE	PR 1LB,1LE-1LF,1LT(288-312disc)da ch.4B-X-070001	FCP1491 LUCAS/TRW
2.8 quattro	142	02/97	→ 01/05	FCP1717	ATE		FCP1491 LUCAS/TRW
3.0	162	08/01	→ 01/05	FCP1629	ATE		
3.0 Quattro	220	08/01	→ 01/05	FCP1629	ATE		
RS6 quattro	331	07/02	→ 01/05	FCP1664	BREMBO		
RS6 quattro	331	07/02	→ 01/05	FCP1664	BREMBO		FCP1655 LUCAS/TRW

A6 (4F2, C6)

2.0 TDi	100	07/04	→ 03/11	FCP1717	ATE	PR1LT(314mm disc)	
2.0 TDi	100	07/04	→ 03/11	FCP1717	ATE		FCP1636 LUCAS/TRW
2.0 TDi	100	07/04	→ 03/11	FCP1717	ATE		FCP1655 LUCAS/TRW
2.0 TDi	103	07/04	→ 10/08	FCP1717	ATE	PR1LT(314mm disc)	
2.0 TDi	103	07/04	→ 10/08	FCP1717	ATE		FCP1636 LUCAS/TRW
2.0 TDi	103	07/04	→ 10/08	FCP1717	ATE		FCP1655 LUCAS/TRW
2.0 TDi	120	04/09	→ 03/11	FCP1717	ATE	PR1LT(314mm disc)	
2.0 TDi	120	04/09	→ 03/11	FCP1717	ATE		FCP1636 LUCAS/TRW
2.0 TDi	120	04/09	→ 03/11	FCP1717	ATE		FCP1655 LUCAS/TRW
2.0 TDi	125	11/08	→ 03/11	FCP1717	ATE	PR1LT(314mm disc)	
2.0 TDi	125	11/08	→ 03/11	FCP1717	ATE		FCP1636 LUCAS/TRW
2.0 TDi	125	11/08	→ 03/11	FCP1717	ATE		FCP1655 LUCAS/TRW
2.0 TDi	89	09/05	→ 06/06	FCP1717	ATE	PR1LT(314mm disc)	
2.0 TDi	89	09/05	→ 06/06	FCP1717	ATE		FCP1636 LUCAS/TRW

For material availability see page 16-18 / Per la disponibilità materiali vedere a pagina 16-18

AUDI



KW



...AUDI

...A6 (4F2, C6)

			NOTE			NOTE		
2.0 TDI	89	09/05 → 06/06				FCP1655	LUCAS/TRW	
2.0 TFSI	125	06/05 → 03/11	FCP1717	ATE	PR1LT(314mm disc)			
2.0 TFSI	125	06/05 → 03/11				FCP1636	LUCAS/TRW	
2.0 TFSI	125	06/05 → 03/11				FCP1655	LUCAS/TRW	
2.4	130	05/04 → 10/08	FCP1717	ATE	PR1LT(314mm disc)			
2.4	130	05/04 → 10/08				FCP1636	LUCAS/TRW	
2.4	130	05/04 → 10/08				FCP1655	LUCAS/TRW	
2.4 quattro	130	01/05 → 10/08	FCP1717	ATE	PR1LT(314mm disc)			
2.4 quattro	130	01/05 → 10/08				FCP1636	LUCAS/TRW	
2.4 quattro	130	01/05 → 10/08				FCP1655	LUCAS/TRW	
2.7 TDI	120	11/04 → 03/11	FCP1717	ATE	PR1LT(314mm disc)			
2.7 TDI	120	11/04 → 03/11				FCP1636	LUCAS/TRW	
2.7 TDI	120	11/04 → 03/11				FCP1655	LUCAS/TRW	
2.7 TDI	132	11/04 → 10/08	FCP1717	ATE	PR1LT(314mm disc)			
2.7 TDI	132	11/04 → 10/08				FCP1636	LUCAS/TRW	
2.7 TDI	132	11/04 → 10/08				FCP1655	LUCAS/TRW	
2.7 TDI	140	10/08 → 03/11	FCP1717	ATE	PR1LT(314mm disc)			
2.7 TDI	140	10/08 → 03/11				FCP1636	LUCAS/TRW	
2.7 TDI	140	10/08 → 03/11				FCP1655	LUCAS/TRW	
2.7 TDI quattro	120	06/05 → 03/11	FCP1717	ATE	PR1LT(314mm disc)			
2.7 TDI quattro	120	06/05 → 03/11				FCP1636	LUCAS/TRW	
2.7 TDI quattro	120	06/05 → 03/11				FCP1655	LUCAS/TRW	
2.7 TDI quattro	132	11/04 → 10/08	FCP1717	ATE	PR1LT(314mm disc)			
2.7 TDI quattro	132	11/04 → 10/08				FCP1636	LUCAS/TRW	
2.7 TDI quattro	132	11/04 → 10/08				FCP1655	LUCAS/TRW	
2.7 TDI quattro	140	10/08 → 03/11	FCP1717	ATE	PR1LT(314mm disc)			
2.7 TDI quattro	140	10/08 → 03/11				FCP1636	LUCAS/TRW	
2.7 TDI quattro	140	10/08 → 03/11				FCP1655	LUCAS/TRW	
2.8 FSI	140	10/08 → 03/11	FCP1717	ATE	PR1LT(314mm disc)			
2.8 FSI	140	10/08 → 03/11				FCP1636	LUCAS/TRW	
2.8 FSI	140	10/08 → 03/11				FCP1655	LUCAS/TRW	
2.8 FSI	154	11/06 → 10/08	FCP1717	ATE	PR1LT(314mm disc)			
2.8 FSI	154	11/06 → 10/08				FCP1636	LUCAS/TRW	
2.8 FSI	154	11/06 → 10/08				FCP1655	LUCAS/TRW	
2.8 FSI	162	10/08 → 03/11	FCP1717	ATE	PR1LT(314mm disc)			
2.8 FSI	162	10/08 → 03/11				FCP1636	LUCAS/TRW	
2.8 FSI	162	10/08 → 03/11				FCP1655	LUCAS/TRW	
2.8 FSI quattro	140	10/08 → 03/11	FCP1717	ATE	PR1LT(314mm disc)			
2.8 FSI quattro	140	10/08 → 03/11				FCP1636	LUCAS/TRW	
2.8 FSI quattro	140	10/08 → 03/11				FCP1655	LUCAS/TRW	
2.8 FSI quattro	154	06/07 → 10/08	FCP1717	ATE	PR1LT(314mm disc)			
2.8 FSI quattro	154	06/07 → 10/08				FCP1636	LUCAS/TRW	
2.8 FSI quattro	154	06/07 → 10/08				FCP1655	LUCAS/TRW	
2.8 FSI quattro	162	10/08 → 03/11	FCP1717	ATE	PR1LT(314mm disc)			
2.8 FSI quattro	162	10/08 → 03/11				FCP1636	LUCAS/TRW	
2.8 FSI quattro	162	10/08 → 03/11				FCP1655	LUCAS/TRW	
3.0	160	08/04 → 05/06	FCP1717	ATE	PR1LT(314mm disc)			
3.0	160	08/04 → 05/06				FCP1636	LUCAS/TRW	
3.0	160	08/04 → 05/06				FCP1655	LUCAS/TRW	
3.0 quattro	160	05/04 → 05/06	FCP1717	ATE	PR1LT(314mm disc)			
3.0 quattro	160	05/04 → 05/06				FCP1636	LUCAS/TRW	
3.0 quattro	160	05/04 → 05/06				FCP1655	LUCAS/TRW	
3.0 TDI	171	06/06 → 03/11	FCP1717	ATE	PR1LT(314mm disc)			
3.0 TDI	171	06/06 → 03/11				FCP1636	LUCAS/TRW	
3.0 TDI	171	06/06 → 03/11				FCP1655	LUCAS/TRW	
3.0 TDI quattro	155	05/04 → 03/11	FCP1717	ATE	PR1LT(314mm disc)			
3.0 TDI quattro	155	05/04 → 03/11				FCP1636	LUCAS/TRW	
3.0 TDI quattro	155	05/04 → 03/11				FCP1655	LUCAS/TRW	
3.0 TDI quattro	165	05/04 → 05/06	FCP1629	ATE	PR 1LD/1LG 1LH/1ZL			
3.0 TDI quattro	165	05/04 → 05/06	FCP1717	ATE	PR1LT(314mm disc)			
3.0 TDI quattro	165	05/04 → 05/06				FCP1655	LUCAS/TRW	PR 1KW/2EE
3.0 TDI quattro	165	05/04 → 05/06				FCP1636	LUCAS/TRW	
3.0 TDI quattro	171	06/06 → 10/08	FCP1717	ATE	PR1LT(314mm disc)			
3.0 TDI quattro	171	06/06 → 10/08				FCP1636	LUCAS/TRW	
3.0 TDI quattro	171	06/06 → 10/08				FCP1655	LUCAS/TRW	
3.0 TDI quattro	176	10/08 → 03/11	FCP1717	ATE	PR1LT(314mm disc)			
3.0 TDI quattro	176	10/08 → 03/11				FCP1636	LUCAS/TRW	
3.0 TDI quattro	176	10/08 → 03/11				FCP1655	LUCAS/TRW	
3.0 TFSI quattro	213	10/08 → 03/11	FCP1717	ATE	PR1LT(314mm disc)			
3.0 TFSI quattro	213	10/08 → 03/11				FCP1636	LUCAS/TRW	
3.0 TFSI quattro	213	10/08 → 03/11				FCP1655	LUCAS/TRW	
3.2 FSI	188	05/04 → 05/09	FCP1717	ATE	PR1LT(314mm disc)			
3.2 FSI	188	05/04 → 05/09				FCP1636	LUCAS/TRW	
3.2 FSI	188	05/04 → 05/09				FCP1655	LUCAS/TRW	
3.2 FSI quattro	183	09/06 → 10/08	FCP1717	ATE	PR1LT(314mm disc)			
3.2 FSI quattro	183	09/06 → 10/08				FCP1636	LUCAS/TRW	
3.2 FSI quattro	183	09/06 → 10/08				FCP1655	LUCAS/TRW	
3.2 FSI quattro	188	05/04 → 10/08	FCP1717	ATE	PR1LT(314mm disc)			

For material availability see page 16-18 / Per la disponibilità materiali vedere a pagina 16-18



...AUDI

...A6 (4F2, C6)

3.2 FSI quattro	188	05/04 → 10/08
3.2 FSI quattro	188	05/04 → 10/08
4.2 FSI Quattro	257	06/06 → 03/11
4.2 FSI Quattro	257	06/06 → 03/11
4.2 FSI Quattro	257	06/06 → 03/11
4.2 FSI Quattro	257	06/06 → 03/11
4.2 Quattro	246	05/04 → 05/06
4.2 Quattro	246	05/04 → 05/06
4.2 Quattro	246	05/04 → 05/06
4.2 Quattro	246	05/04 → 05/06
RS6 quattro	426	09/08 → 03/11
RS6 quattro	426	09/08 → 03/11
S6 quattro	320	03/06 → 03/11

FCP1629	ATE	PR 1LD,1LG,1LH,1ZL
FCP1717	ATE	PR1LT(314mm disc)
FCP1629	ATE	PR 1LD,1LG,1LH,1ZL
FCP1717	ATE	PR1LT(314mm disc)
FRP3133	BREMBO	NOT FOR CERAMIC DISCS

FCP1636	LUCAS/TRW	
FCP1655	LUCAS/TRW	
FCP1636	LUCAS/TRW	
FCP1655	LUCAS/TRW	PR 1KW/2EE
FCP1636	LUCAS/TRW	
FCP1655	LUCAS/TRW	PR 1KW/2EE
FCP1655	LUCAS/TRW	PR 1KJ
FCP1655	LUCAS/TRW	PR 1KW/2EE/2EL

A6 (4G2, C7, 4GC)

2.0 TDI	100	01/12 →
2.0 TDI	100	01/12 →
2.0 TDI	120	03/11 →
2.0 TDI	120	03/11 →
2.0 TDI	130	03/11 →
2.0 TDI	130	03/11 →
2.0 TDI	140	11/13 →
2.0 TDI	140	11/13 →
2.0 TDI	140	11/13 →
2.0 TDI quattro	140	04/15 →
2.0 TFSI	132	05/11 →
2.0 TFSI	132	05/11 →
2.0 TFSI	155	03/11 → 05/13
2.0 TFSI	155	03/11 → 05/13
2.0 TFSI	185	09/14 →
2.0 TFSI hybrid	155	11/11 →
2.0 TFSI hybrid	155	11/11 →
2.0 TFSI quattro	183	05/15 →
2.0 TFSI quattro	185	05/14 →
2.8 FSI	150	03/11 →
2.8 FSI	150	03/11 →
2.8 FSI quattro	150	03/11 →
2.8 FSI quattro	150	03/11 →
3.0 TDI	150	11/10 →
3.0 TDI	150	11/10 →
3.0 TDI	160	09/14 →
3.0 TDI quattro	150	03/11 →
3.0 TDI quattro	150	03/11 →
3.0 TDI quattro	155	09/14 →
3.0 TDI quattro	180	03/11 →
3.0 TDI quattro	180	03/11 →
3.0 TDI quattro	200	09/14 →
3.0 TDI quattro	230	11/11 →
3.0 TDI quattro	230	11/11 →
3.0 TDI quattro	235	09/14 →
3.0 TDI quattro	240	09/14 →
3.0 TFSI quattro	220	11/10 → 05/12
3.0 TFSI quattro	220	11/10 → 05/12
3.0 TFSI quattro	228	03/11 →
3.0 TFSI quattro	228	03/11 →
S6 quattro	309	02/12 →
S6 quattro	309	02/12 →
S6 quattro	331	10/14 →

FCP4468	BREMBO	NOT FOR CERAMIC DISCS,Disc Diam 400,PR 1LU
FCP4466	BREMBO	NOT FOR CERAMIC DISCS,Disc Diam 400,PR 1LW
FCP4468	BREMBO	NOT FOR CERAMIC DISCS,Disc Diam 400,PR 1LU
FCP4466	BREMBO	NOT FOR CERAMIC DISCS,Disc Diam 400,PR 1LW
FCP4468	BREMBO	NOT FOR CERAMIC DISCS,Disc Diam 400,PR 1LU
FCP4466	BREMBO	NOT FOR CERAMIC DISCS,Disc Diam 400,PR 1LW
FCP4468	BREMBO	NOT FOR CERAMIC DISCS,Disc Diam 400,PR 1LU
FCP4466	BREMBO	NOT FOR CERAMIC DISCS,Disc Diam 400,PR 1LW
FCP4468	BREMBO	NOT FOR CERAMIC DISCS,Disc Diam 400,PR 1LU
FCP4466	BREMBO	NOT FOR CERAMIC DISCS,Disc Diam 400,PR 1LW
FCP4468	BREMBO	NOT FOR CERAMIC DISCS,Disc Diam 400,PR 1LU
FCP4466	BREMBO	NOT FOR CERAMIC DISCS,Disc Diam 400,PR 1LW
FCP4468	BREMBO	NOT FOR CERAMIC DISCS,Disc Diam 400,PR 1LU
FCP4466	BREMBO	NOT FOR CERAMIC DISCS,Disc Diam 400,PR 1LW
FCP4468	BREMBO	NOT FOR CERAMIC DISCS,Disc Diam 400,PR 1LU
FCP4466	BREMBO	NOT FOR CERAMIC DISCS,Disc Diam 400,PR 1LW
FCP4468	BREMBO	NOT FOR CERAMIC DISCS,Disc Diam 400,PR 1LU
FCP4466	BREMBO	NOT FOR CERAMIC DISCS,Disc Diam 400,PR 1LW
FCP4468	BREMBO	NOT FOR CERAMIC DISCS,Disc Diam 400,PR 1LU
FCP4466	BREMBO	NOT FOR CERAMIC DISCS,Disc Diam 400,PR 1LW
FCP4468	BREMBO	NOT FOR CERAMIC DISCS,Disc Diam 400,PR 1LU
FCP4466	BREMBO	NOT FOR CERAMIC DISCS,Disc Diam 400,PR 1LW
FCP4468	BREMBO	NOT FOR CERAMIC DISCS,Disc Diam 400,PR 1LU
FCP4466	BREMBO	NOT FOR CERAMIC DISCS,Disc Diam 400,PR 1LW
FCP4468	BREMBO	NOT FOR CERAMIC DISCS,Disc Diam 400,PR 1LU
FCP4466	BREMBO	NOT FOR CERAMIC DISCS,Disc Diam 400,PR 1LW
FCP4468	BREMBO	NOT FOR CERAMIC DISCS,Disc Diam 400,PR 1LU
FCP4466	BREMBO	NOT FOR CERAMIC DISCS,Disc Diam 400,PR 1LW
FCP4468	BREMBO	NOT FOR CERAMIC DISCS,Disc Diam 400,PR 1LU
FCP4466	BREMBO	NOT FOR CERAMIC DISCS,Disc Diam 400,PR 1LW
FCP4468	BREMBO	NOT FOR CERAMIC DISCS,Disc Diam 400,PR 1LU
FCP4466	BREMBO	NOT FOR CERAMIC DISCS,Disc Diam 400,PR 1LW
FCP4468	BREMBO	NOT FOR CERAMIC DISCS,Disc Diam 400,PR 1LU

FCP1636	LUCAS/TRW	
FCP1655	LUCAS/TRW	
FCP1636	LUCAS/TRW	
FCP1655	LUCAS/TRW	PR 1KW
FCP1636	LUCAS/TRW	
FCP1655	LUCAS/TRW	PR 1KW
FCP1636	LUCAS/TRW	
FCP1655	LUCAS/TRW	PR 1KW
FCP1636	LUCAS/TRW	
FCP1655	LUCAS/TRW	PR 1KW
FCP1636	LUCAS/TRW	
FCP1655	LUCAS/TRW	PR 1KW
FCP1636	LUCAS/TRW	
FCP1655	LUCAS/TRW	PR 1KW
FCP1636	LUCAS/TRW	
FCP1655	LUCAS/TRW	PR 1KW
FCP1636	LUCAS/TRW	
FCP1655	LUCAS/TRW	PR 1KW
FCP1636	LUCAS/TRW	
FCP1655	LUCAS/TRW	PR 1KW
FCP1636	LUCAS/TRW	
FCP1655	LUCAS/TRW	PR 1KW
FCP1636	LUCAS/TRW	
FCP1655	LUCAS/TRW	PR 1KW
FCP1636	LUCAS/TRW	
FCP1655	LUCAS/TRW	PR 1KW

A6 Allroad (4FH, C6)

2.7 TDI quattro	132	05/06 → 10/08
2.7 TDI quattro	132	05/06 → 08/11
2.7 TDI quattro	132	05/06 → 10/08
2.7 TDI quattro	132	05/06 → 08/11
2.7 TDI quattro - with electric Handbrake	120	05/06 → 08/11
2.7 TDI quattro - with electric Handbrake	120	05/06 → 08/11
2.7 TDI quattro - with electric Handbrake	140	05/06 → 08/11
2.7 TDI quattro - with electric Handbrake	140	05/06 → 08/11
3.0 TDI quattro	171	05/06 → 10/08
3.0 TDI quattro	171	05/06 → 08/11
3.0 TDI quattro	171	05/06 → 10/08
3.0 TDI quattro	171	05/06 → 08/11
3.0 TDI quattro - with electric Handbrake	155	05/06 → 08/11
3.0 TDI quattro - with electric Handbrake	155	05/06 → 08/11
3.0 TDI quattro - with electric Handbrake	176	05/06 → 08/11
3.0 TDI quattro - with electric Handbrake	176	05/06 → 08/11
3.0 TFSI quattro - with electric Handbrake	213	10/08 → 08/11

FCP1629	ATE	PR 1LD,1LG,1LH,1ZL
FCP1629	ATE	PR 1LG/1ZL
FCP1629	ATE	PR 1LG/1ZL
FCP1629	ATE	PR 1LG/1ZL
FCP1629	ATE	PR 1LG/1ZL
FCP1629	ATE	PR 1LG/1ZL
FCP1629	ATE	PR 1LD,1LG,1LH,1ZL
FCP1629	ATE	PR 1LG/1ZL
FCP1629	ATE	PR 1LG/1ZL
FCP1629	ATE	PR 1LG/1ZL
FCP1629	ATE	PR 1LG/1ZL
FCP1629	ATE	PR 1LG/1ZL
FCP1629	ATE	PR 1LG/1ZL
FCP1629	ATE	PR 1LG/1ZL
FCP1629	ATE	PR 1LG/1ZL
FCP1629	ATE	PR 1LG/1ZL
FCP1629	ATE	PR 1LG/1ZL
FCP1629	ATE	PR 1LG/1ZL
FCP1629	ATE	PR 1LG/1ZL

FCP1636	LUCAS/TRW	
FCP1655	LUCAS/TRW	PR 1KW
FCP1636	LUCAS/TRW	
FCP1655	LUCAS/TRW	PR 1KW
FCP1636	LUCAS/TRW	
FCP1655	LUCAS/TRW	PR 1KW
FCP1636	LUCAS/TRW	
FCP1655	LUCAS/TRW	PR 1KW
FCP1636	LUCAS/TRW	
FCP1655	LUCAS/TRW	PR 1KW
FCP1636	LUCAS/TRW	
FCP1655	LUCAS/TRW	PR 1KW
FCP1636	LUCAS/TRW	
FCP1655	LUCAS/TRW	PR 1KW
FCP1636	LUCAS/TRW	
FCP1655	LUCAS/TRW	PR 1KW
FCP1636	LUCAS/TRW	
FCP1655	LUCAS/TRW	PR 1KW
FCP1636	LUCAS/TRW	
FCP1655	LUCAS/TRW	PR 1KW
FCP1636	LUCAS/TRW	
FCP1655	LUCAS/TRW	PR 1KW

For material availability see page 16-18 / Per la disponibilità materiali vedere a pagina 16-18



KW



...AUDI

...A6 Avant (4B5, C5)

			NOTE			NOTE		
1.9 TDI	85	07/00 → 01/05	FCP1717	ATE	PR 1LB,1LE-1LF,1LT(288-312disc)da ch.4B-X-070001	FCP1491	LUCAS/TRW	
1.9 TDI	96	08/01 → 01/05				FCP1491	LUCAS/TRW	
1.9 TDI	96	08/01 → 01/05						
1.9 TDi	81	03/97 → 03/04	FCP1323	ATE				
1.9 TDi	81	12/97 → 04/04	FCP1323	ATE				
2.0	96	08/01 → 01/05	FCP1717	ATE	PR 1LB,1LE-1LF,1LT(288-312disc)da ch.4B-X-070001			
2.0	96	08/01 → 01/05				FCP1491	LUCAS/TRW	
2.0 i	103	03/97 → 03/04	FCP1323	ATE				
2.0 i	96	03/97 → 03/04	FCP1323	ATE				
2.0 i	96	08/01 → 04/04	FCP1323	ATE				
2.4	100	07/98 → 01/05	FCP1717	ATE	PR 1LB,1LE-1LF,1LT(288-312disc)da ch.4B-X-070001			
2.4	100	07/98 → 01/05				FCP1491	LUCAS/TRW	
2.4	115	12/97 → 01/05	FCP1717	ATE	PR 1LB,1LE-1LF,1LT(288-312disc)da ch.4B-X-070001			
2.4	115	12/97 → 01/05				FCP1491	LUCAS/TRW	
2.4	120	12/97 → 01/05	FCP1717	ATE	PR 1LB,1LE-1LF,1LT(288-312disc)da ch.4B-X-070001			
2.4	120	12/97 → 01/05				FCP1491	LUCAS/TRW	
2.4	121	12/97 → 01/05	FCP1717	ATE	PR 1LB,1LE-1LF,1LT(288-312disc)da ch.4B-X-070001			
2.4	121	12/97 → 01/05				FCP1491	LUCAS/TRW	
2.4	125	08/01 → 01/05	FCP1717	ATE	PR 1LB,1LE-1LF,1LT(288-312disc)da ch.4B-X-070001			
2.4	125	08/01 → 01/05				FCP1491	LUCAS/TRW	
2.4 30V	100	05/97 → 03/04	FCP1323	ATE				
2.4 30V	100	05/97 → 03/04				FCP541	LUCAS/TRW	
2.4 30V	120	05/97 → 03/04	FCP1323	ATE				
2.4 30V	120	05/97 → 03/04				FCP541	LUCAS/TRW	
2.4 30V	121	05/97 → 03/04	FCP1323	ATE				
2.4 30V	121	05/97 → 03/04				FCP541	LUCAS/TRW	
2.4 quattro	115	08/98 → 05/01	FCP1717	ATE	PR 1LB,1LE-1LF,1LT(288-312disc)da ch.4B-X-070001			
2.4 quattro	115	08/98 → 05/01				FCP1491	LUCAS/TRW	
2.4 quattro	120	12/97 → 01/05	FCP1717	ATE	PR 1LB,1LE-1LF,1LT(288-312disc)da ch.4B-X-070001			
2.4 quattro	120	12/97 → 01/05				FCP1491	LUCAS/TRW	
2.4 quattro	121	12/97 → 01/05	FCP1717	ATE	PR 1LB,1LE-1LF,1LT(288-312disc)da ch.4B-X-070001			
2.4 quattro	121	12/97 → 01/05				FCP1491	LUCAS/TRW	
2.4 quattro	125	08/01 → 01/05	FCP1717	ATE	PR 1LB,1LE-1LF,1LT(288-312disc)da ch.4B-X-070001			
2.4 quattro	125	08/01 → 01/05				FCP1491	LUCAS/TRW	
2.5 TDi	85	04/97 → 03/04	FCP1323	ATE				
2.5 TDi	110	12/97 → 01/05	FCP1717	ATE	PR 1LB,1LE-1LF,1LT(288-312disc)da ch.4B-X-070001			
2.5 TDi	110	12/97 → 01/05				FCP1491	LUCAS/TRW	
2.5 TDi	114	08/01 → 01/05	FCP1717	ATE	PR 1LB,1LE-1LF,1LT(288-312disc)da ch.4B-X-070001			
2.5 TDi	114	08/01 → 01/05				FCP1491	LUCAS/TRW	
2.5 TDi	120	07/02 → 01/05	FCP1717	ATE	PR 1LB,1LE-1LF,1LT(288-312disc)da ch.4B-X-070001			
2.5 TDi	120	07/02 → 01/05				FCP1491	LUCAS/TRW	
2.5 TDi	132	02/00 → 01/05	FCP1717	ATE	PR 1LB,1LE-1LF,1LT(288-312disc)da ch.4B-X-070001			
2.5 TDi	132	02/00 → 01/05				FCP1491	LUCAS/TRW	
2.5 TDi	85	12/97 → 04/04	FCP1323	ATE				
2.5 TDi quattro	110	12/97 → 01/05	FCP1717	ATE	PR 1LB,1LE-1LF,1LT(288-312disc)da ch.4B-X-070001			
2.5 TDi quattro	110	12/97 → 01/05				FCP1491	LUCAS/TRW	
2.5 TDi quattro	132	02/00 → 01/05	FCP1717	ATE	PR 1LB,1LE-1LF,1LT(288-312disc)da ch.4B-X-070001			
2.5 TDi quattro	132	02/00 → 01/05				FCP1491	LUCAS/TRW	
2.8	132	12/97 → 05/00	FCP1717	ATE	PR 1LB,1LE-1LF,1LT(288-312disc)da ch.4B-X-070001			
2.8	132	12/97 → 05/00				FCP1491	LUCAS/TRW	
2.8	140	07/99 → 01/05	FCP1717	ATE	PR 1LB,1LE-1LF,1LT(288-312disc)da ch.4B-X-070001			
2.8	140	07/99 → 01/05				FCP1491	LUCAS/TRW	
2.8	142	12/97 → 01/05	FCP1717	ATE	PR 1LB,1LE-1LF,1LT(288-312disc)da ch.4B-X-070001			
2.8	142	12/97 → 01/05				FCP1491	LUCAS/TRW	
2.8 i	142	03/97 → 03/04	FCP1323	ATE				
2.8 quattro	142	12/97 → 01/05	FCP1717	ATE	PR 1LB,1LE-1LF,1LT(288-312disc)da ch.4B-X-070001			
2.8 quattro	142	12/97 → 01/05				FCP1491	LUCAS/TRW	
3.0	162	08/01 → 01/05	FCP1717	ATE	PR 1LB,1LE-1LF,1LT(288-312disc)da ch.4B-X-070001			
3.0	162	08/01 → 01/05				FCP1491	LUCAS/TRW	
3.0 quattro	162	08/01 → 01/05	FCP1717	ATE	PR 1LB,1LE-1LF,1LT(288-312disc)da ch.4B-X-070001			
3.0 quattro	162	08/01 → 01/05				FCP1491	LUCAS/TRW	
RS6 plus quattro	353	04/04 → 01/05	FCP1664	BREMBO				
RS6 plus quattro	353	04/04 → 01/05				FCP1655	LUCAS/TRW	
RS6 quattro	331	07/02 → 01/05	FCP1664	BREMBO				
RS6 quattro	331	07/02 → 01/05				FCP1655	LUCAS/TRW	
A6 Avant (4F5, C6)								
2.0 TDi	100	06/05 → 08/11	FCP1717	ATE	PR1LT(314mm disc)			
2.0 TDi	100	06/05 → 08/11				FCP1636	LUCAS/TRW	
2.0 TDi	100	06/05 → 08/11				FCP1655	LUCAS/TRW	
2.0 TDi	103	06/05 → 10/08	FCP1717	ATE	PR1LT(314mm disc)			
2.0 TDi	103	06/05 → 10/08				FCP1636	LUCAS/TRW	
2.0 TDi	103	06/05 → 10/08				FCP1655	LUCAS/TRW	
2.0 TDi	120	04/09 → 08/11	FCP1717	ATE	PR1LT(314mm disc)			
2.0 TDi	120	04/09 → 08/11				FCP1636	LUCAS/TRW	
2.0 TDi	120	04/09 → 08/11				FCP1655	LUCAS/TRW	
2.0 TDi	125	10/08 → 08/11	FCP1717	ATE	PR1LT(314mm disc)			

For material availability see page 16-18 / Per la disponibilità materiali vedere a pagina 16-18



KW



...AUDI

...A6 Avant (4F5, C6)

			NOTE			NOTE		
2.0 TDI	125	10/08 → 08/11				FCP1636	LUCAS/TRW	
2.0 TDI	125	10/08 → 08/11				FCP1655	LUCAS/TRW	
2.0 TDI	89	09/05 → 06/06	FCP1717	ATE	PR1LT(314mm disc)			
2.0 TDI	89	09/05 → 06/06				FCP1636	LUCAS/TRW	
2.0 TDI	89	09/05 → 06/06				FCP1655	LUCAS/TRW	
2.0 TFSI	125	06/05 → 08/11	FCP1717	ATE	PR1LT(314mm disc)			
2.0 TFSI	125	06/05 → 08/11				FCP1636	LUCAS/TRW	
2.0 TFSI	125	06/05 → 08/11				FCP1655	LUCAS/TRW	
2.4	130	03/05 → 10/08	FCP1717	ATE	PR1LT(314mm disc)			
2.4	130	03/05 → 10/08				FCP1636	LUCAS/TRW	
2.4	130	03/05 → 10/08				FCP1655	LUCAS/TRW	
2.4 quattro	130	03/05 → 10/08	FCP1717	ATE	PR1LT(314mm disc)			
2.4 quattro	130	03/05 → 10/08				FCP1636	LUCAS/TRW	
2.4 quattro	130	03/05 → 10/08				FCP1655	LUCAS/TRW	
2.7 TDI	120	03/05 → 08/11	FCP1717	ATE	PR1LT(314mm disc)			
2.7 TDI	120	03/05 → 08/11				FCP1636	LUCAS/TRW	
2.7 TDI	120	03/05 → 08/11				FCP1655	LUCAS/TRW	
2.7 TDI	132	03/05 → 10/08	FCP1717	ATE	PR1LT(314mm disc)			
2.7 TDI	132	03/05 → 10/08				FCP1636	LUCAS/TRW	
2.7 TDI	132	03/05 → 10/08				FCP1655	LUCAS/TRW	
2.7 TDI	140	10/08 → 08/11	FCP1717	ATE	PR1LT(314mm disc)			
2.7 TDI	140	10/08 → 08/11				FCP1636	LUCAS/TRW	
2.7 TDI	140	10/08 → 08/11				FCP1655	LUCAS/TRW	
2.7 TDI quattro	120	06/05 → 08/11	FCP1717	ATE	PR1LT(314mm disc)			
2.7 TDI quattro	120	06/05 → 08/11				FCP1636	LUCAS/TRW	
2.7 TDI quattro	120	06/05 → 08/11				FCP1655	LUCAS/TRW	
2.7 TDI quattro	132	03/05 → 10/08	FCP1717	ATE	PR1LT(314mm disc)			
2.7 TDI quattro	132	03/05 → 10/08				FCP1636	LUCAS/TRW	
2.7 TDI quattro	132	03/05 → 10/08				FCP1655	LUCAS/TRW	
2.7 TDI quattro	140	10/08 → 08/11	FCP1717	ATE	PR1LT(314mm disc)			
2.7 TDI quattro	140	10/08 → 08/11				FCP1636	LUCAS/TRW	
2.7 TDI quattro	140	10/08 → 08/11				FCP1655	LUCAS/TRW	
2.8 FSI	140	10/08 → 08/11	FCP1717	ATE	PR1LT(314mm disc)			
2.8 FSI	140	10/08 → 08/11				FCP1636	LUCAS/TRW	
2.8 FSI	140	10/08 → 08/11				FCP1655	LUCAS/TRW	
2.8 FSI	154	11/06 → 10/08	FCP1717	ATE	PR1LT(314mm disc)			
2.8 FSI	154	11/06 → 10/08				FCP1636	LUCAS/TRW	
2.8 FSI	154	11/06 → 10/08				FCP1655	LUCAS/TRW	
2.8 FSI	162	10/08 → 08/11	FCP1717	ATE	PR1LT(314mm disc)			
2.8 FSI	162	10/08 → 08/11				FCP1636	LUCAS/TRW	
2.8 FSI	162	10/08 → 08/11				FCP1655	LUCAS/TRW	
2.8 FSI quattro	140	10/08 → 08/11	FCP1717	ATE	PR1LT(314mm disc)			
2.8 FSI quattro	140	10/08 → 08/11				FCP1636	LUCAS/TRW	
2.8 FSI quattro	140	10/08 → 08/11				FCP1655	LUCAS/TRW	
2.8 FSI quattro	154	06/07 → 10/08	FCP1717	ATE	PR1LT(314mm disc)			
2.8 FSI quattro	154	06/07 → 10/08				FCP1636	LUCAS/TRW	
2.8 FSI quattro	154	06/07 → 10/08				FCP1655	LUCAS/TRW	
2.8 FSI quattro	162	10/08 → 08/11	FCP1717	ATE	PR1LT(314mm disc)			
2.8 FSI quattro	162	10/08 → 08/11				FCP1636	LUCAS/TRW	
2.8 FSI quattro	162	10/08 → 08/11				FCP1655	LUCAS/TRW	
3.0	160	03/05 → 05/06	FCP1717	ATE	PR1LT(314mm disc)			
3.0	160	03/05 → 05/06				FCP1636	LUCAS/TRW	
3.0	160	03/05 → 05/06				FCP1655	LUCAS/TRW	
3.0 quattro	160	03/05 → 05/06	FCP1717	ATE	PR1LT(314mm disc)			
3.0 quattro	160	03/05 → 05/06				FCP1636	LUCAS/TRW	
3.0 quattro	160	03/05 → 05/06				FCP1655	LUCAS/TRW	
3.0 TDi	171	06/06 → 08/11	FCP1717	ATE	PR1LT(314mm disc)			
3.0 TDi	171	06/06 → 08/11				FCP1636	LUCAS/TRW	
3.0 TDi	171	06/06 → 08/11				FCP1655	LUCAS/TRW	
3.0 TDi quattro	155	03/05 → 08/11	FCP1717	ATE	PR1LT(314mm disc)			
3.0 TDi quattro	155	03/05 → 08/11				FCP1636	LUCAS/TRW	
3.0 TDi quattro	155	03/05 → 08/11				FCP1655	LUCAS/TRW	
3.0 TDi quattro	165	03/05 → 05/06	FCP1717	ATE	PR1LB,1LE(288mm disc)1LT,1LF(312mm disc)			
3.0 TDi quattro	165	03/05 → 05/06	FCP1629	ATE	PR 1LD/1LG 1LH/1ZL			
3.0 TDi quattro	165	03/05 → 05/06				FCP1636	LUCAS/TRW	
3.0 TDi quattro	165	03/05 → 05/06				FCP1655	LUCAS/TRW	PR 1KW/2EE
3.0 TDi quattro	171	06/06 → 10/08	FCP1717	ATE	PR1LT(314mm disc)			
3.0 TDi quattro	171	06/06 → 10/08				FCP1636	LUCAS/TRW	
3.0 TDi quattro	171	06/06 → 10/08				FCP1655	LUCAS/TRW	
3.0 TDi quattro	176	10/08 → 08/11	FCP1717	ATE	PR1LT(314mm disc)			
3.0 TDi quattro	176	10/08 → 08/11				FCP1636	LUCAS/TRW	
3.0 TDi quattro	176	10/08 → 08/11				FCP1655	LUCAS/TRW	
3.0 TFSI quattro	213	10/08 → 08/11	FCP1717	ATE	PR1LT(314mm disc)			
3.0 TFSI quattro	213	10/08 → 08/11				FCP1636	LUCAS/TRW	
3.0 TFSI quattro	213	10/08 → 08/11				FCP1655	LUCAS/TRW	
3.2 FSI	188	03/05 → 10/08	FCP1717	ATE	PR1LT(314mm disc)			
3.2 FSI	188	03/05 → 10/08				FCP1636	LUCAS/TRW	
3.2 FSI	188	03/05 → 10/08				FCP1655	LUCAS/TRW	

For material availability see page 16-18 / Per la disponibilità materiali vedere a pagina 16-18



KW

**...AUDI****...A6 Avant (4F5, C6)**

			NOTE			NOTE		
3.2 FSI quattro	188	03/05 → 10/08	FCP1717	ATE	PR1LT(314mm disc)			
3.2 FSI quattro	188	03/05 → 10/08				FCP1636	LUCAS/TRW	
3.2 FSI quattro	188	03/05 → 10/08				FCP1655	LUCAS/TRW	
4.2 FSI quattro	257	06/06 → 08/11	FCP1717	ATE	PR1LT(314mm disc)			
4.2 FSI quattro	257	06/06 → 08/11	FCP1629	ATE	PR 1LD,1LG,1LH,1ZL			
4.2 FSI quattro	257	06/06 → 08/11				FCP1636	LUCAS/TRW	
4.2 FSI quattro	257	06/06 → 08/11				FCP1655	LUCAS/TRW	PR 1KW/2EE
4.2 quattro	246	03/05 → 05/06	FCP1717	ATE	PR1LT(314mm disc)			
4.2 quattro	246	03/05 → 05/06	FCP1629	ATE	PR 1LD,1LG,1LH,1ZL			
4.2 quattro	246	03/05 → 05/06				FCP1636	LUCAS/TRW	
4.2 quattro	246	03/05 → 05/06				FCP1655	LUCAS/TRW	PR 1KW/2EE
RS6 quattro	426	04/08 → 08/10	FRP3133	BREMBO	NOT FOR CERAMIC DISCS			
RS6 quattro	426	04/08 → 08/10				FCP1655	LUCAS/TRW	PR 1KJ
S6 quattro	320	06/06 → 08/11				FCP1655	LUCAS/TRW	PR 1KW/2EE/2EL

A6 Avant (4G5, C7, 4GD)

2.0 TDI	100	01/12 →	FCP4468	BREMBO	NOT FOR CERAMIC DISCS,Disc Diam 400,PR 1LU			
2.0 TDI	100	01/12 →	FCP4466	BREMBO	NOT FOR CERAMIC DISCS,Disc Diam 400,PR 1LW			
2.0 TDI	110	09/14 →	FCP4468	BREMBO	NOT FOR CERAMIC DISCS,Disc Diam 400,PR 1LU			
2.0 TDI	120	05/11 →	FCP4468	BREMBO	NOT FOR CERAMIC DISCS,Disc Diam 400,PR 1LU			
2.0 TDI	120	05/11 →	FCP4466	BREMBO	NOT FOR CERAMIC DISCS,Disc Diam 400,PR 1LW			
2.0 TDI	130	05/11 →	FCP4468	BREMBO	NOT FOR CERAMIC DISCS,Disc Diam 400,PR 1LU			
2.0 TDI	130	05/11 →	FCP4466	BREMBO	NOT FOR CERAMIC DISCS,Disc Diam 400,PR 1LW			
2.0 TDI	140	11/13 →	FCP4468	BREMBO	NOT FOR CERAMIC DISCS,Disc Diam 400,PR 1LU			
2.0 TDI	140	11/13 →	FCP4466	BREMBO	NOT FOR CERAMIC DISCS,Disc Diam 400,PR 1LW			
2.0 TDI quattro	140	04/15 →	FCP4468	BREMBO	NOT FOR CERAMIC DISCS,Disc Diam 400,PR 1LU			
2.0 TFSI	132	06/11 →	FCP4468	BREMBO	NOT FOR USE WITH CERAMIC DISCS ,For PR code:1LU			
2.0 TFSI	132	06/11 →	FCP4466	BREMBO	NOT FOR CERAMIC DISCS,Disc Diam 400,PR 1LW			
2.0 TFSI quattro	183	05/15 →	FCP4468	BREMBO	NOT FOR CERAMIC DISCS,Disc Diam 400,PR 1LU			
2.0 TFSI quattro	185	05/15 →	FCP4468	BREMBO	NOT FOR CERAMIC DISCS,Disc Diam 400,PR 1LU			
2.8 FSI	150	05/11 →	FCP4468	BREMBO	NOT FOR CERAMIC DISCS,Disc Diam 400,PR 1LU			
2.8 FSI	150	05/11 →	FCP4466	BREMBO	NOT FOR CERAMIC DISCS,Disc Diam 400,PR 1LW			
2.8 FSI quattro	150	05/11 →	FCP4468	BREMBO	NOT FOR CERAMIC DISCS,Disc Diam 400,PR 1LU			
2.8 FSI quattro	150	05/11 →	FCP4466	BREMBO	NOT FOR CERAMIC DISCS,Disc Diam 400,PR 1LW			
3.0 TDI	150	05/11 →	FCP4468	BREMBO	NOT FOR CERAMIC DISCS,Disc Diam 400,PR 1LU			
3.0 TDI	150	05/11 →	FCP4466	BREMBO	NOT FOR CERAMIC DISCS,Disc Diam 400,PR 1LW			
3.0 TDI	155	09/14 →	FCP4468	BREMBO	NOT FOR CERAMIC DISCS,Disc Diam 400,PR 1LU			
3.0 TDI quattro	150	05/11 →	FCP4468	BREMBO	NOT FOR CERAMIC DISCS,Disc Diam 400,PR 1LU			
3.0 TDI quattro	150	05/11 →	FCP4466	BREMBO	NOT FOR CERAMIC DISCS,Disc Diam 400,PR 1LW			
3.0 TDI quattro	155	09/14 →	FCP4468	BREMBO	NOT FOR CERAMIC DISCS,Disc Diam 400,PR 1LU			
3.0 TDI quattro	160	09/14 →	FCP4468	BREMBO	NOT FOR CERAMIC DISCS,Disc Diam 400,PR 1LU			
3.0 TDI quattro	180	05/11 →	FCP4468	BREMBO	NOT FOR CERAMIC DISCS,Disc Diam 400,PR 1LU			
3.0 TDI quattro	180	05/11 →	FCP4466	BREMBO	NOT FOR CERAMIC DISCS,Disc Diam 400,PR 1LW			
3.0 TDI quattro	230	11/11 →	FCP4468	BREMBO	NOT FOR CERAMIC DISCS,Disc Diam 400,PR 1LU			
3.0 TDI quattro	230	11/11 →	FCP4466	BREMBO	NOT FOR CERAMIC DISCS,Disc Diam 400,PR 1LW			
3.0 TDI quattro	240	09/14 →	FCP4468	BREMBO	NOT FOR CERAMIC DISCS,Disc Diam 400,PR 1LU			
3.0 TFSI quattro	220	05/11 → 05/12	FCP4468	BREMBO	NOT FOR CERAMIC DISCS,Disc Diam 400,PR 1LU			
3.0 TFSI quattro	220	05/11 → 05/12	FCP4466	BREMBO	NOT FOR CERAMIC DISCS,Disc Diam 400,PR 1LW			
3.0 TFSI quattro	228	11/11 →	FCP4468	BREMBO	NOT FOR CERAMIC DISCS,Disc Diam 400,PR 1LU			
3.0 TFSI quattro	228	11/11 →	FCP4466	BREMBO	NOT FOR CERAMIC DISCS,Disc Diam 400,PR 1LW			
3.0 TFSI quattro	245	09/14 →	FCP4468	BREMBO	NOT FOR CERAMIC DISCS,Disc Diam 400,PR 1LU			
RS6 performance quattro	445	11/15 →	FCP4468	BREMBO	NOT FOR CERAMIC DISCS,PR 1LM,1LX			
RS6 performance quattro	445	11/15 →	FCP4466	BREMBO	NOT FOR CERAMIC DISCS,PR 1LN			
RS6 performance quattro	445	11/15 →				FCP4050	LUCAS/TRW	
RS6 quattro	412	01/13 →	FCP4466	BREMBO	NOT FOR CERAMIC DISCS,PR 1LN			
RS6 quattro	412	01/13 →	FCP4468	BREMBO	NOT FOR USE WITH CERAMIC DISCS, 1LM,1LX			
RS6 quattro	412	01/13 →				FCP4050	LUCAS/TRW	
S6 quattro	309	02/12 →	FCP4468	BREMBO	NOT FOR CERAMIC DISCS,Disc Diam 400,PR 1LU			
S6 quattro	309	02/12 →	FCP4466	BREMBO	NOT FOR CERAMIC DISCS,Disc Diam 400,PR 1LW			
S6 quattro	331	10/14 →	FCP4468	BREMBO	NOT FOR CERAMIC DISCS,Disc Diam 400,PR 1LU			

A7 Sportback (4GA, 4GF)

1.8 TFSI	140	04/15 →	FCP4468	BREMBO	NOT FOR CERAMIC DISCS ,From:2015-11,PR 1LU			
2.0 TFSI	185	09/14 →	FCP4468	BREMBO	NOT FOR USE WITH CERAMIC DISCS ,For PR code:1LU			
2.0 TFSI quattro	183	05/15 →	FCP4468	BREMBO	NOT FOR CERAMIC DISCS ,From:2015-11,PR 1LU			
2.0 TFSI quattro	185	05/15 →	FCP4468	BREMBO	NOT FOR CERAMIC DISCS ,From:2015-11,PR 1LU			
2.8 FSI	150	02/11 →	FCP4468	BREMBO	NOT FOR USE WITH CERAMIC DISCS ,For PR code:1LU			
2.8 FSI	150	02/11 →	FCP4466	BREMBO	NOT FOR CERAMIC DISCS,Disc Diam 400,PR 1LW			
2.8 FSI quattro	150	10/10 →	FCP4468	BREMBO	NOT FOR USE WITH CERAMIC DISCS ,For PR code:1LU			
2.8 FSI quattro	150	10/10 →	FCP4466	BREMBO	NOT FOR CERAMIC DISCS,Disc Diam 400,PR 1LW			
3.0 TDI	150	11/10 →	FCP4468	BREMBO	NOT FOR USE WITH CERAMIC DISCS ,For PR code:1LU			
3.0 TDI	150	11/10 →	FCP4466	BREMBO	NOT FOR CERAMIC DISCS,Disc Diam 400,PR 1LW			
3.0 TDI	160	07/14 →	FCP4468	BREMBO	NOT FOR USE WITH CERAMIC DISCS ,For PR code:1LU			
3.0 TDI	160	07/14 →	FCP4466	BREMBO	NOT FOR CERAMIC DISCS,Disc Diam 400,PR 1LW			
3.0 TDI quattro	150	12/10 →	FCP4468	BREMBO	NOT FOR USE WITH CERAMIC DISCS ,For PR code:1LU			
3.0 TDI quattro	150	12/10 →	FCP4466	BREMBO	NOT FOR CERAMIC DISCS,Disc Diam 400,PR 1LW			
3.0 TDI quattro	155	07/14 →	FCP4468	BREMBO	NOT FOR USE WITH CERAMIC DISCS ,For PR code:1LU			

For material availability see page 16-18 / Per la disponibilità materiali vedere a pagina 16-18



KW



...AUDI					NOTE			NOTE
...A7 Sportback (4GA, 4GF)								
3.0 TDI quattro	155	07/14 →	FCP4466	BREMBO	NOT FOR USE WITH CERAMIC DISCS ,For PR code:1LW			
3.0 TDI quattro	160	07/14 →	FCP4468	BREMBO	NOT FOR USE WITH CERAMIC DISCS ,For PR code:1LU			
3.0 TDI quattro	160	07/14 →	FCP4466	BREMBO	NOT FOR USE WITH CERAMIC DISCS ,For PR code:1LW			
3.0 TDI quattro	176	05/13 →	FCP4468	BREMBO	NOT FOR USE WITH CERAMIC DISCS ,For PR code:1LU			
3.0 TDI quattro	176	05/13 →	FCP4466	BREMBO	NOT FOR USE WITH CERAMIC DISCS ,For PR code:1LW			
3.0 TDI quattro	180	10/10 →	FCP4468	BREMBO	NOT FOR USE WITH CERAMIC DISCS ,For PR code:1LU			
3.0 TDI quattro	180	10/10 →	FCP4466	BREMBO	NOT FOR CERAMIC DISCS,Disc Diam 400,PR 1LW			
3.0 TDI quattro	200	05/14 →	FCP4468	BREMBO	NOT FOR USE WITH CERAMIC DISCS ,For PR code:1LU			
3.0 TDI quattro	200	05/14 →	FCP4466	BREMBO	NOT FOR USE WITH CERAMIC DISCS ,For PR code:1LW			
3.0 TDI quattro	230	11/11 →	FCP4468	BREMBO	NOT FOR USE WITH CERAMIC DISCS ,For PR code:1LU			
3.0 TDI quattro	230	11/11 →	FCP4466	BREMBO	NOT FOR CERAMIC DISCS,Disc Diam 400,PR 1LW			
3.0 TDI quattro	235	05/14 →	FCP4468	BREMBO	NOT FOR USE WITH CERAMIC DISCS ,For PR code:1LU			
3.0 TDI quattro	235	05/14 →	FCP4466	BREMBO	NOT FOR USE WITH CERAMIC DISCS ,For PR code:1LW			
3.0 TDI quattro	240	09/14 →	FCP4468	BREMBO	NOT FOR USE WITH CERAMIC DISCS ,For PR code:1LU			
3.0 TDI quattro	240	09/14 →	FCP4466	BREMBO	NOT FOR USE WITH CERAMIC DISCS ,For PR code:1LW			
3.0 TFSI quattro	220	10/10 →	FCP4468	BREMBO	NOT FOR USE WITH CERAMIC DISCS ,For PR code:1LU			
3.0 TFSI quattro	220	10/10 →	FCP4466	BREMBO	NOT FOR CERAMIC DISCS,Disc Diam 400,PR 1LW			
3.0 TFSI quattro	228	01/11 →	FCP4468	BREMBO	NOT FOR USE WITH CERAMIC DISCS ,For PR code:1LU			
3.0 TFSI quattro	228	01/11 →	FCP4466	BREMBO	NOT FOR CERAMIC DISCS,Disc Diam 400,PR 1LW			
3.0 TFSI quattro	245	05/14 →	FCP4468	BREMBO	NOT FOR USE WITH CERAMIC DISCS ,For PR code:1LU			
3.0 TFSI quattro	245	05/14 →	FCP4466	BREMBO	NOT FOR USE WITH CERAMIC DISCS ,For PR code:1LW			
RS7 performance quattro	445	11/15 →	FCP4468	BREMBO	For vehicles without ceramics discs,PR 1LM,1LX			
RS7 performance quattro	445	11/15 →				FCP4050	LUCAS/TRW	
RS7 quattro	412	10/13 →	FCP4466	BREMBO	NOT FOR CERAMIC DISCS,PR 1LN			
RS7 quattro	412	10/13 →	FCP4468	BREMBO	For vehicles without ceramic discs, PR 1LM,1LX			
RS7 quattro	412	10/13 →				FCP4050	LUCAS/TRW	
S7 quattro	309	02/12 →	FCP4468	BREMBO	NOT FOR USE WITH CERAMIC DISCS ,For PR code:1LU			
S7 quattro	309	02/12 →	FCP4466	BREMBO	NOT FOR CERAMIC DISCS,Disc Diam 400,PR 1LW			
S7 quattro	331	07/14 →	FCP4468	BREMBO	NOT FOR USE WITH CERAMIC DISCS ,For PR code:1LU			
S7 quattro	331	07/14 →	FCP4466	BREMBO	NOT FOR USE WITH CERAMIC DISCS ,For PR code:1LW			
A8								
2.5 TDi	110	06/94 → 03/96	FCP590	ATE				
2.5 TDi	110	06/94 → 03/96				FCP596	LUCAS/TRW	
2.5 TDi	110	06/94 → 03/96				FCP541	LUCAS/TRW	
2.5 TDi	132	06/00 → 10/02	FCP891	ATE				
2.5 TDi 24V	110	04/96 → 05/00	FCP590	ATE				
2.5 TDi 24V	110	04/96 → 05/00				FCP596	LUCAS/TRW	
2.5 TDi 24V	110	04/96 → 05/00				FCP541	LUCAS/TRW	
2.8	128	06/94 → 03/96	FCP590	ATE				
2.8	128	06/94 → 03/96				FCP596	LUCAS/TRW	
2.8	128	06/94 → 03/96				FCP541	LUCAS/TRW	
3.3 TDi 32V	165	06/00 → 10/02	FCP891	ATE				
3.3 TDi 32V	165	08/00 → 10/02	FCP891	ATE				
3.7 32V	169	09/94 → 07/96	FCP590	ATE				
3.7 32V	169	09/94 → 07/96				FCP596	LUCAS/TRW	
3.7 32V	169	09/94 → 07/96				FCP541	LUCAS/TRW	
3.7 32V	169	08/96 → 10/98	FCP590	ATE				
3.7 32V	169	08/96 → 10/98				FCP596	LUCAS/TRW	
3.7 32V	169	08/96 → 10/98				FCP541	LUCAS/TRW	
3.7 40V	191	11/98 → 10/02	FCP891	ATE				
3.7 40V	191	11/98 → 10/02				FCP541	LUCAS/TRW	
A8 (4D2, 4D8)								
2.5 TDi 24v quattro	132	11/99 → 09/02	FCP1001	ATE				
2.5 TDi 24v quattro	132	11/99 → 09/02				FCP1491	LUCAS/TRW	
2.5 TDi 32V quattro	132	06/00 →	FCP891	ATE				
2.5 TDi V6 quattro	103	01/97 → 05/00	FCP590	ATE				
2.5 TDi V6 quattro	103	01/97 → 05/00				FCP541	LUCAS/TRW	
2.8 30v quattro	142	11/98 → 09/02	FCP1001	ATE	PR 1LJ, From Ch. 4DX005501			
2.8 30v quattro	142	11/98 → 09/02				FCP1491	LUCAS/TRW	
2.8 30V quattro	142	04/96 → 10/02	FCP590	ATE				
2.8 30V quattro	142	04/96 → 10/02				FCP596	LUCAS/TRW	
2.8 30V quattro	142	04/96 → 10/02				FCP541	LUCAS/TRW	
2.8 quattro	128	03/94 → 03/96	FCP590	ATE				
2.8 quattro	128	03/94 → 03/96				FCP596	LUCAS/TRW	
2.8 quattro	128	03/94 → 03/96				FCP541	LUCAS/TRW	
3.3 TDi 32v quattro	165	12/99 → 09/02	FCP1001	ATE				
3.3 TDi 32v quattro	165	12/99 → 09/02				FCP1491	LUCAS/TRW	
3.7 32V quattro	169	07/95 → 10/98	FCP590	ATE				
3.7 32V quattro	169	07/95 → 10/98				FCP596	LUCAS/TRW	
3.7 32V quattro	169	07/95 → 10/98				FCP541	LUCAS/TRW	
3.7 40v	191	10/98 → 09/02	FCP1001	ATE	PR 1LJ			
3.7 40v	191	10/98 → 09/02				FCP1491	LUCAS/TRW	
3.7 40v quattro	191	01/99 → 09/02	FCP1001	ATE	PR 1LJ, From Ch. 4DX005501			
3.7 40v quattro	191	01/99 → 09/02				FCP1491	LUCAS/TRW	
3.7 40V quattro	191	11/98 → 10/02	FCP891	ATE				

For material availability see page 16-18 / Per la disponibilità materiali vedere a pagina 16-18



KW

**...AUDI****...A8 (4H_)**

4.0 TFSI quattro	309	03/12 →	FCP4468	BREMBO	NOT FOR CERAMIC DISCS & armoured vehicle,PR 1LN
4.0 TFSI quattro	309	03/12 →	FCP4466	BREMBO	NOT FOR CERAMIC&Armoured,Disc 400mm,PR 1LW
4.0 TFSI quattro	320	10/13 →	FCP4466	BREMBO	NOT FOR CERAMIC DISCS,Disc Diam 400,PR 1LW
4.2 FSI quattro	273	11/09 →	FCP4468	BREMBO	NOT FOR CERAMIC DISCS & armoured vehicle,PR 1LN
4.2 FSI quattro	273	11/09 →	FCP4466	BREMBO	NOT FOR CERAMIC&Armoured,Disc 400mm,PR 1LW
4.2 TDI quattro	258	11/09 →	FCP4468	BREMBO	NOT FOR CERAMIC DISCS & armoured vehicle,PR 1LN
4.2 TDI quattro	258	11/09 →	FCP4466	BREMBO	NOT FOR CERAMIC&Armoured,Disc 400mm,PR 1LW
4.2 TDI quattro	283	10/13 →	FCP4466	BREMBO	NOT FOR CERAMIC DISCS,Disc Diam 400,PR 1LW
6.3 W12 quattro	368	01/11 →	FCP4468	BREMBO	NOT FOR CERAMIC DISCS & armoured vehicle,PR 1LN
6.3 W12 quattro	368	01/11 →	FCP4466	BREMBO	NOT FOR CERAMIC&Armoured,Disc 400mm,PR 1LW
S8 quattro	382	04/12 →	FCP4468	BREMBO	NOT FOR CERAMIC DISCS & armoured vehicle,PR 1LN
S8 quattro	382	04/12 →	FCP4466	BREMBO	NOT FOR CERAMIC DISCS

NOTE**NOTE****Cabrio**

1.6		01/91 → 07/98	FCP775	LUCAS/TRW	
1.6		01/91 → 07/98			FCP596 LUCAS/TRW
1.8 20V	92	01/91 → 03/97	FCP775	LUCAS/TRW	
1.8 20V	92	01/91 → 03/97			FCP596 LUCAS/TRW
1.8 20V	92	04/97 → 07/98	FCP774	LUCAS/TRW	
1.8 20V	92	04/97 → 07/98			FCP596 LUCAS/TRW
1.9 TDi	66	01/95 → 07/98	FCP775	LUCAS/TRW	
1.9 TDi	66	01/95 → 07/98			FCP596 LUCAS/TRW
2.0 16V	85, 103	01/91 → 07/98	FCP775	LUCAS/TRW	
2.0 16V	85, 103	01/91 → 07/98			FCP596 LUCAS/TRW
2.3 E	98	01/91 → 07/98	FCP775	LUCAS/TRW	
2.3 E	98	01/91 → 07/98			FCP596 LUCAS/TRW
2.6	110	01/93 → 07/98	FCP775	LUCAS/TRW	
2.6	110	01/93 → 07/98			FCP596 LUCAS/TRW

Coupe

1.6	55	01/80 → 07/84	FCP370	LUCAS/TRW	
1.8	64, 82	01/87 → 07/89	FCP774	LUCAS/TRW	
1.8	64, 82	01/87 → 07/89			FCP596 LUCAS/TRW
1.8	64	01/80 → 08/85	FCP370	LUCAS/TRW	
1.8	64	09/85 → 12/86	FCP774	LUCAS/TRW	
1.8	64	09/85 → 12/86			FCP596 LUCAS/TRW
1.8	66	01/80 → 08/85	FCP370	LUCAS/TRW	
1.8	66	09/85 → 12/86	FCP774	LUCAS/TRW	
1.8	66	09/85 → 12/86			FCP596 LUCAS/TRW
1.8	68	01/80 → 08/85	FCP370	LUCAS/TRW	
1.8	68	09/85 → 12/86	FCP774	LUCAS/TRW	
1.8	68	09/85 → 12/86			FCP596 LUCAS/TRW
1.9	85	01/80 → 08/85	FCP370	LUCAS/TRW	
1.9 10V	85	09/85 → 12/88	FCP774	LUCAS/TRW	
1.9 10V	85	09/85 → 12/88			FCP596 LUCAS/TRW
2.0	85	01/80 → 08/85	FCP370	LUCAS/TRW	
2.0	85	09/85 → 08/89	FCP774	LUCAS/TRW	
2.0	85	09/85 → 08/89			FCP596 LUCAS/TRW
2.0	85	09/89 → 07/92	FCP775	LUCAS/TRW	
2.0	85	09/89 → 07/92			FCP596 LUCAS/TRW
2.0	85	08/92 → 12/96	FCP776	AKEBONO	
2.0	85	08/92 → 12/96			FCP596 LUCAS/TRW
2.2 10V	85, 100	01/86 → 08/89	FCP774	LUCAS/TRW	
2.2 10V	85, 100	01/86 → 08/89			FCP596 LUCAS/TRW
2.2 i	77, 85	02/81 → 12/85	FCP370	LUCAS/TRW	
2.2 i	77, 85	02/81 → 12/85			FCP596 LUCAS/TRW
2.2 i	96	02/81 → 12/85	FCP370	LUCAS/TRW	
2.2 i	96	02/81 → 12/85			FCP596 LUCAS/TRW
2.2 S2 (Turbo) 20V	162, 169	10/90 → 12/96	FCP590	ATE	
2.2 S2 (Turbo) 20V	162, 169	10/90 → 12/96			FCP596 LUCAS/TRW
2.3	100	02/87 → 12/89	FCP775	LUCAS/TRW	
2.3	100	02/87 → 12/89			FCP596 LUCAS/TRW
2.3 E	98	01/90 → 07/92	FCP775	LUCAS/TRW	
2.3 E	98	01/90 → 07/92			FCP596 LUCAS/TRW
2.3 E	98	08/92 → 12/96	FCP775	LUCAS/TRW	
2.3 E	98	08/92 → 12/96			FCP596 LUCAS/TRW
2.8 E	128	01/91 → 12/96	FCP590	ATE	
2.8 E	128	01/91 → 12/96			FCP596 LUCAS/TRW

Coupe Quattro

1.8		11/84 → 08/87	FCP774	LUCAS/TRW	
1.8		11/84 → 08/87			FCP596 LUCAS/TRW
2.0 10V	118	09/80 → 10/84	FCP370	LUCAS/TRW	
2.0 10V	118	11/84 → 09/88	FCP774	LUCAS/TRW	
2.0 10V	118	11/84 → 09/88			FCP596 LUCAS/TRW
2.2	89, 100	01/85 → 09/88	FCP774	LUCAS/TRW	
2.2	89, 100	01/85 → 09/88			FCP596 LUCAS/TRW

For material availability see page 16-18 / Per la disponibilità materiali vedere a pagina 16-18

1040

FERODO

RACING

Updated on 17th Aug 2018



KW

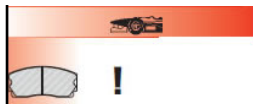

...AUDI			NOTE			NOTE		
...Coupe Quattro								
2.3	98	01/85 → 09/88	FCP774	LUCAS/TRW				
2.3	98	01/85 → 09/88				FCP596	LUCAS/TRW	
Q2 (GAB)								
1.0 TFSI	85	10/16 →	FCP4433	TRW	Disc Diam mm:312,For PR code:1ZA			
1.0 TFSI	85	10/16 →				FCP4434	ATE	Disc Diam mm:272,For PR code:1KE
1.4 TFSI	110	06/16 →	FCP4433	TRW	Disc Diam mm:312,For PR code:1ZA			
1.4 TFSI	110	06/16 →				FCP4434	ATE	Disc Diam mm:272,For PR code:1KE
1.6 TDI	85	06/16 →	FCP4433	TRW	Disc Diam mm:312,For PR code:1ZA			
1.6 TDI	85	06/16 →				FCP4434	ATE	Disc Diam mm:272,For PR code:1KE
2.0 TDI	110	09/16 →	FCP4433	TRW	Disc Diam mm:312,For PR code:1ZA			
2.0 TDI	110	09/16 →				FCP4434	ATE	Disc Diam mm:272,For PR code:1KE
2.0 TDI quattro	110	09/16 →	FCP4433	TRW	Disc Diam mm:312,For PR code:1ZA			
2.0 TDI quattro	110	09/16 →				FCP4434	ATE	Disc Diam mm:272,For PR code:1KE
2.0 TDI quattro	140	07/16 →	FCP4433	TRW	Disc Diam mm:312,For PR code:1ZA			
2.0 TDI quattro	140	07/16 →				FCP4434	ATE	Disc Diam mm:272,For PR code:1KE
Q3 (8U)								
2.5 RS quattro	250	02/15 →	FCP1664	BREMBO	PR 1LA,1ZT			
Q3 (8UB, 8UG)								
RS 2.5 quattro	228	02/15 →	FCP1664	BREMBO	PR 1LA,1ZT			
Q5								
2.0 Tdi Quattro	125	11/08 →	FCP4044	LUCAS/TRW				
2.0 Tdi Quattro	125	11/08 →				FCP4050	LUCAS/TRW	
2.0 TFSI	155	11/08 →	FCP4044	LUCAS/TRW				
2.0 TFSI	155	11/08 →				FCP4050	LUCAS/TRW	
3.0 TDI Quattro	176	11/08 →	FCP4044	LUCAS/TRW				
3.0 TDI Quattro	176	11/08 →				FCP4050	LUCAS/TRW	
3.2 FSI Quattro	199	11/08 →	FCP4044	LUCAS/TRW				
3.2 FSI Quattro	199	11/08 →				FCP4050	LUCAS/TRW	
Q7								
3.0 TDI	155	03/06 → 05/10	FCP4064	BREMBO	PR 1LT			
3.0 TDI	171	03/06 → 05/08	FCP4064	BREMBO	PR 1LT			
3.0 TDI Quattro	171	03/06 →	FCP1626	BREMBO				
3.6 FSI Quattro	206	08/06 →	FCP1626	BREMBO				
4.2 FSI Quattro	257	03/06 →	FCP1626	BREMBO				
Q7 (4L)								
3.6 FSI	206	08/06 → 05/10	FCP4064	BREMBO	PR 1LT			
3.6 FSI	206	08/06 → 05/10				FCP1308	BREMBO	For PR number 2EA
4.2 FSI	257	03/06 → 05/10	FCP4064	BREMBO	PR 1LT			
4.2 FSI	257	03/06 → 05/10				FCP1308	BREMBO	For PR number 2EA
4.2 TDI	240	03/07 → 06/09	FCP1626	BREMBO				
4.2 TDI	240	03/07 → 06/09	FCP4064	BREMBO	PR 1LT			
4.2 TDI	240	03/07 → 06/09				FCP1308	BREMBO	For PR number 2EA
6.0 TDI	368	09/08 → 05/14				FCP1308	BREMBO	For PR number 2EA
R8								
4.2 FSI quattro	309	04/07 → 09/10	FCP1664	BREMBO				
4.2 FSI quattro	309	04/07 → 09/10	FCP4467	BREMBO	NOT FOR CERAMIC DISCS			
4.2 FSI quattro	309	04/07 → 09/10				FCP1281	BREMBO	
4.2 FSI quattro	316	07/10 → 07/15	FCP1664	BREMBO	PR 1LA			
4.2 FSI quattro	316	07/10 → 07/15	FCP4467	BREMBO	NOT FOR CERAMIC DISCS			
4.2 FSI quattro	316	07/10 → 07/15				FCP1281	BREMBO	PR 2ED
5.2 FSI quattro	386	04/09 → 07/15	FCP1664	BREMBO	PR 1LA			
5.2 FSI quattro	386	04/09 → 07/15	FCP4467	BREMBO	NOT FOR CERAMIC DISCS			
5.2 FSI quattro	386	04/09 → 07/15				FCP1281	BREMBO	PR 2ED
5.2 FSI quattro	404	05/12 → 07/15	FCP1664	Brembo				
5.2 FSI quattro	404	05/12 → 07/15	FCP4467	BREMBO	NOT FOR CERAMIC DISCS			
5.2 FSI quattro	412	11/10 → 07/15	FCP1664	BREMBO	PR 1LA			
5.2 FSI quattro	412	11/10 → 07/15	FCP4467	BREMBO	NOT FOR CERAMIC DISCS			
5.2 FSI quattro	412	11/10 → 07/15				FCP1664	BREMBO	PR 2ED
5.2 FSI quattro	419	07/14 → 07/15	FCP4467	BREMBO	NOT FOR CERAMIC DISCS			
R8 Spyder								
4.2 FSI quattro	316	09/10 → 07/15	FCP1664	BREMBO	PR 1LA			
4.2 FSI quattro	316	09/10 → 07/15	FCP4467	BREMBO	NOT FOR CERAMIC DISCS			
4.2 FSI quattro	316	09/10 → 07/15				FCP1281	BREMBO	PR 2ED
5.2 FSI quattro	386	02/10 → 07/15	FCP1664	BREMBO	PR 1LA			
5.2 FSI quattro	386	02/10 → 07/15	FCP4467	BREMBO	NOT FOR CERAMIC DISCS			
5.2 FSI quattro	386	02/10 → 07/15				FCP1281	BREMBO	PR 2ED
5.2 FSI quattro	404	05/12 →	FCP4467	BREMBO	NOT FOR CERAMIC DISCS			
5.2 FSI quattro	412	11/11 → 07/15	FCP1664	BREMBO	PR 1LA			

For material availability see page 16-18 / Per la disponibilità materiali vedere a pagina 16-18



KW



...AUDI

...R8 Spyder

5.2 FSI quattro	412	11/11 → 07/15	FCP4467	BREMBO	NOT FOR CERAMIC DISCS			
5.2 FSI quattro	412	11/11 → 07/15				FCP1664	BREMBO	PR 2ED

S8 Quattro

4.2 32V	250	07/96 → 09/98	FCP590	ATE				
4.2 32V	250	07/96 → 09/98				FCP596	LUCAS/TRW	
4.2 40V	265	06/99 →	FCP891	ATE				

Sport Quattro

2.1	225	01/80 → 07/86	FCP775	LUCAS/TRW				
2.1	225	01/80 → 07/86				FCP596	LUCAS/TRW	
2.2		01/80 → 07/86	FCP775	LUCAS/TRW				
2.2		01/80 → 07/86				FCP596	LUCAS/TRW	

TT

1.8 20V	132	04/99 →	FCP590	ATE				
1.8 20V, Coupe Roadster	132	04/99 →	FCP590	ATE				
1.8 20V, Coupe Roadster	132	04/99 →				FCP541	LUCAS/TRW	

TT (8J3)

1.8 TFSI	118	06/08 → 06/14	FCP4223	ATE	For PR code:1LK/1LM			
1.8 TFSI	118	06/08 → 06/14	FCP1641	ATE	For PR code:1LJ/1LL			
1.8 TFSI	118	06/08 → 06/14				FCP1636	LUCAS/TRW	Disc Diam mm:286,For PR code:1KZ/2ED
2.0 TDI quattro	125	06/08 → 06/14	FCP4223	ATE	For PR code:1LK/1LM,From Chassis:8J8028001			
2.0 TDI quattro	125	06/08 → 06/14	FCP1641	ATE	For PR code:1LJ/1LL,From Chassis:8J8011001			
2.0 TDI quattro	125	06/08 → 06/14				FCP1636	LUCAS/TRW	Disc Diam mm:286,For PR code:1KJ/2EE
2.0 TFSI	147	08/06 → 06/10	FCP1641	ATE	Disc Diam mm:312,For PR code:1LJ,1LL			
2.0 TFSI	147	08/06 → 06/10	FCP4223	ATE	For PR code:1LK/1LM			
2.0 TFSI	147	08/06 → 06/10				FCP1636	LUCAS/TRW	Disc Diam mm:286,For PR code:1KZ/2ED
2.0 TFSI quattro	147	06/08 → 06/10	FCP4223	ATE	For PR code:1LK/1LM,From Chassis:8J8028001			
2.0 TFSI quattro	147	06/08 → 06/10	FCP1641	ATE	For PR code:1LJ/1LL,From Chassis:8J8011001			
2.0 TFSI quattro	147	06/08 → 06/10				FCP1636	LUCAS/TRW	Disc Diam mm:286,For PR code:1KJ/2EE
2.0 TTS quattro	195	05/08 → 06/14	FCP4223	ATE				
2.0 TTS quattro	195	05/08 → 06/14				FCP1636	LUCAS/TRW	
2.0 TTS quattro	200	05/08 → 06/14	FCP1765	ATE				
2.0 TTS quattro	200	05/08 → 06/14	FCP4223	ATE				
2.0 TTS quattro	200	05/08 → 06/14				FCP1636	LUCAS/TRW	
2.5 RS quattro	265	05/11 → 06/14	FCP1334	BREMBO	For PR number 1LA			
2.5 RS quattro	265	05/11 → 06/14				FCP1636	LUCAS/TRW	For PR number 2EG
2.5 TFSI Quattro	250	07/09 → 06/14	FCP1334	BREMBO				
2.5 TFSI Quattro	250	07/09 → 06/14				FCP1636	LUCAS/TRW	
3.2 V6 quattro	184	08/06 → 06/10	FCP1765	ATE				
3.2 V6 quattro	184	08/06 → 06/10	FCP1641	ATE				
3.2 V6 quattro	184	08/06 → 06/10	FCP4223	ATE	For PR code:1LK/1LM			
3.2 V6 quattro	184	08/06 → 06/10				FCP1636	LUCAS/TRW	Disc Diam mm:286,For PR code:1KJ/2EE

TT (FV3)

1.8 TFSI	132	08/15 →	FCP4433	LUCAS/TRW				
1.8 TFSI	132	08/15 →				FCP4697	ATE	For PR code:2ED/2EG/2EK
1.8 TFSI	132	08/15 →				FCP4434	ATE	For PR code:1KZ
2.0 TDI	135	07/14 →	FCP4433	LUCAS/TRW				
2.0 TDI	135	07/14 →				FCP4697	ATE	For PR code:2ED/2EG/2EK
2.0 TDI	135	07/14 →				FCP4434	ATE	For PR code:1KZ
2.0 TDI quattro	135	01/17 →	FCP4433	TRW	Disc Diam mm:312,For PR code:1LJ/1ZD			
2.0 TDI quattro	135	01/17 →				FCP4434	ATE	Disc Diam mm:272,For PR code:1KZ
2.0 TFSI	169	07/14 →	FCP4433	LUCAS/TRW				
2.0 TFSI	169	07/14 →				FCP4697	ATE	For PR code:2ED/2EG/2EK
2.0 TFSI quattro	169	07/14 →	FCP4433	LUCAS/TRW				
2.0 TFSI quattro	169	07/14 →				FCP4697	ATE	For PR code:2ED/2EG/2EK
2.0 TTS quattro	210	02/15 →	FCP4433	LUCAS/TRW				
2.0 TTS quattro	210	02/15 →				FCP4697	ATE	Disc Diam mm:300/310,For PR code:2ED/2EG/2EK
2.0 TTS quattro	228	11/14 →	FCP4433	LUCAS/TRW	Pr Number 1LJ,1ZD			
2.0 TTS quattro	228	11/14 →				FCP4697	ATE	For PR code:2ED
2.5 RS Quattro	294	10/16 →	FCP4433	LUCAS/TRW	For PR number 1LJ, 1ZD			
2.5 RS Quattro	294	10/16 →				FCP4697	ATE	For PR number 1KZ, 2EG, 2EK, 2ED

TT Quattro

1.8 20V		04/99 →	FCP590	ATE				
1.8 20V		04/99 →				FCP541	LUCAS/TRW	

TT Quattro (8N9-8N3)

3.2 24v	184	07/03 → 12/06	FCP1001	ATE	PR 1ZT			
3.2 24v	184	07/03 → 12/06				FCP1491	LUCAS/TRW	

For material availability see page 16-18 / Per la disponibilità materiali vedere a pagina 16-18



KW

**...AUDI****TT Roadster (8J9)**

					NOTE			NOTE
1.8 TFSI	118	06/08 → 06/14	FCP4223	ATE	For PR code:1LK/1LM			
1.8 TFSI	118	06/08 → 06/14	FCP1641	ATE	For PR code:1LJ/1LL			
1.8 TFSI	118	06/08 → 06/14				FCP1636	LUCAS/TRW	Disc Diam mm:286,For PR code:1KZ/2ED
2.0 TDI quattro	125	06/08 → 06/14	FCP4223	ATE	For PR code:1LK/1LM,From Chassis:8J8028001			
2.0 TDI quattro	125	06/08 → 06/14	FCP1641	ATE	For PR code:1LJ/1LL,From Chassis:8J8011001			
2.0 TDI quattro	125	06/08 → 06/14				FCP1636	LUCAS/TRW	Disc Diam mm:286,For PR code:1KJ/2EE
2.0 TFSI	147	03/07 → 06/10	FCP4223	ATE	For PR code:1LK/1LM			
2.0 TFSI	147	03/07 → 06/10	FCP1641	ATE	Disc Diam mm:312,For PR code:1LJ,1LL			
2.0 TFSI	147	03/07 → 06/10				FCP1636	LUCAS/TRW	Disc Diam mm:286,For PR code:1KZ/2ED
2.0 TFSI quattro	147	06/08 → 06/10	FCP4223	ATE	For PR code:1LK/1LM,From Chassis:8J8028001			
2.0 TFSI quattro	147	06/08 → 06/10	FCP1641	ATE	For PR code:1LJ/1LL,From Chassis:8J8011001			
2.0 TFSI quattro	147	06/08 → 06/10				FCP1636	LUCAS/TRW	Disc Diam mm:286,For PR code:1KJ/2EE
2.0 TTS quattro	195	05/08 → 06/14	FCP4223	ATE				
2.0 TTS quattro	195	05/08 → 06/14				FCP1636	LUCAS/TRW	For PR code:2EA/2EF/2EG
2.0 TTS quattro	200	05/08 → 06/14	FCP1765	ATE				
2.0 TTS quattro	200	05/08 → 06/14	FCP4223	ATE				
2.0 TTS quattro	200	05/08 → 06/14				FCP1636	LUCAS/TRW	
2.5 TFSI Quattro	250	07/09 → 06/14	FCP1334	BREMBO				
2.5 TFSI Quattro	250	07/09 → 06/14				FCP1636	LUCAS/TRW	
2.5 TFSI Quattro	265	03/12 → 06/14	FCP1334	BREMBO	PR 2EA,2EF,2EG			
2.5 TFSI Quattro	265	03/12 → 06/14				FCP1636	LUCAS/TRW	
3.2 V6 quattro	184	03/07 → 06/10	FCP1765	ATE				
3.2 V6 quattro	184	03/07 → 06/10	FCP4223	ATE	For PR code:1LK/1LM			
3.2 V6 quattro	184	03/07 → 06/10				FCP1636	LUCAS/TRW	Disc Diam mm:286,For PR code:1KJ/2EE

TT Roadster (FV9)

1.8 TFSI	132	08/15 →	FCP4433	LUCAS/TRW				
1.8 TFSI	132	08/15 →				FCP4697	ATE	For PR code:2ED/2EG/2EK
1.8 TFSI	132	08/15 →				FCP4434	ATE	For PR code:1KZ
2.0 TDI	135	11/14 →	FCP4433	LUCAS/TRW				
2.0 TDI	135	11/14 →				FCP4697	ATE	For PR code:2ED/2EG/2EK
2.0 TDI	135	11/14 →				FCP4434	ATE	For PR code:1KZ
2.0 TDI quattro	135	01/17 →	FCP4433	TRW	Disc Diam mm:312,For PR code:1LJ/1ZD			
2.0 TDI quattro	135	01/17 →				FCP4434	ATE	Disc Diam mm:272,For PR code:1KZ
2.0 TFSI	169	11/14 →	FCP4433	LUCAS/TRW				
2.0 TFSI	169	11/14 →				FCP4697	ATE	For PR code:2ED/2EG/2EK
2.0 TFSI quattro	169	11/14 →	FCP4433	LUCAS/TRW				
2.0 TFSI quattro	169	11/14 →				FCP4697	ATE	For PR code:2ED/2EG/2EK
2.0 TFSI quattro	215	07/15 →				FCP4697	ATE	
2.0 TTS quattro	210	02/15 →	FCP4433	LUCAS/TRW				
2.0 TTS quattro	210	02/15 →				FCP4697	ATE	Disc Diam mm:300/310,For PR code:2ED/2EG/2EK
2.0 TTS quattro	228	11/14 →	FCP4433	LUCAS/TRW				
2.0 TTS quattro	228	11/14 →				FCP4697	ATE	For PR code:2ED

AUTOBIANCHI**A111**

1.4 Berlina	54	04/69 → 10/73	FCP29	BENDIX				
-------------	----	---------------	-------	--------	--	--	--	--

A112

0.9	35, 37	06/71 → 10/82	FCP29	BENDIX				
0.9	35, 37	11/82 → 12/86	FCP29	BENDIX				
1.0	35, 37	06/71 → 10/82	FCP29	BENDIX				
1.0	35, 37	11/82 → 12/86	FCP29	BENDIX				

Y10

1.0		01/90 → 12/96	FCP351	BENDIX				
1.0 (Fire/Touring/4WD)	33	02/85 → 12/89	FCP351	BENDIX				
1.0 (Fire/Touring/4WD)	33	01/89 → 12/92	FCP351	BENDIX				
1.0 (Fire/Touring/4WD)	33	01/93 → 12/96	FCP351	BENDIX				
1.0 (Turbo)		02/85 → 12/89	FCP370	LUCAS/TRW				
1.0 (Turbo)	33	01/89 → 12/92	FCP351	BENDIX				
1.0 (Turbo)	33	01/93 → 12/96	FCP351	BENDIX				
1.1		01/85 → 12/89	FCP370	LUCAS/TRW				
1.1		01/90 → 12/96	FCP351	BENDIX				
1.1 (Fire/Touring/4WD)	37	06/86 → 12/92	FCP351	BENDIX				
1.1 (Fire/Touring/4WD)	37	01/93 → 12/96	FCP351	BENDIX				
1.3		01/90 → 12/96	FCP370	LUCAS/TRW				
1.3 ie GT	57	02/85 → 12/88	FCP370	LUCAS/TRW				
1.3 ie GT	57	01/89 → 12/94	FCP370	LUCAS/TRW				
1.3 ie GT	57	01/94 → 12/96	FCP370	LUCAS/TRW				
1.3 Not ie GT		02/85 → 12/92	FCP351	BENDIX				
1.3 Not ie GT		01/93 → 12/96	FCP351	BENDIX				

For material availability see page 16-18 / Per la disponibilità materiali vedere a pagina 16-18



KW



BMW					NOTE			NOTE
02 (E10)								
1502 1.6	55	01/75 → 12/77	FCP2	ATE				
1600Ti 1.6	63	01/64 → 12/66	FCP2	ATE				
1 (E81)								
116 d	66	01/11 → 12/11				FCP1806	LUCAS/TRW	
116 d	85	11/08 → 09/12	FCP1747	LUCAS/TRW				
116 d	85	11/08 → 09/12				FCP1806	LUCAS/TRW	
116 i	85	03/07 → 09/12	FCP1747	LUCAS/TRW				
116 i	85	03/07 → 09/12				FCP1806	LUCAS/TRW	
118 d	90	09/06 → 09/12	FCP1747	LUCAS/TRW				
118 d	90	09/06 → 09/12				FCP1806	LUCAS/TRW	
118i	95	09/06 → 09/12	FCP1747	LUCAS/TRW				
118i	95	09/06 → 09/12				FCP1806	LUCAS/TRW	
120 d	120	09/06 → 09/12	FCP1751	ATE				
120 d	120	09/06 → 09/12				FCP1806	LUCAS/TRW	
120 i	125	09/06 → 12/11	FCP1773	ATE	For vehicles without Sport package			
120 i	125	09/06 → 12/11				FCP1806	LUCAS/TRW	For vehicles without Sport package
120 i	125	09/06 → 12/11				FCP1807	ATE	For vehicles with Sport package
120 i	110	09/06 → 09/12	FCP1751	ATE				
120 i	110	09/06 → 09/12				FCP1807	ATE	
123 d	150	03/07 → 09/12	FCP1773	ATE				
123 d	150	03/07 → 09/12				FCP1807	ATE	
130 i	195	09/06 → 09/12	FCP1773	ATE				
130 i	195	09/06 → 09/12				FCP1807	ATE	
1 (E82)								
120d Coupe'	130	10/07 →	FCP1773	ATE				
120d Coupe'	130	10/07 →				FCP1807	ATE	
123d Coupe'	150	10/07 →	FCP1773	ATE				
123d Coupe'	150	10/07 →				FCP1807	ATE	
125i Coupe'	160	10/07 →	FCP1773	ATE				
125i Coupe'	160	10/07 →				FCP1807	ATE	
135i Coupe'	225	10/07 →	FCP4218	BREMBO				
135i Coupe'	225	10/07 →				FCP4217	BREMBO	
3.0 M Coupe' std caliper	250	04/11 →	FCP1628	ATE				
3.0 M Coupe' std caliper	250	04/11 →	FCP4218	BREMBO				
3.0 M Coupe' std caliper	250	04/11 →				FCP1672	ATE	
3.0 M Coupe' std caliper	250	04/11 →				FCP4217	BREMBO	
1 (E87)								
116 d	66	01/11 → 12/11				FCP1806	LUCAS/TRW	
116 d	85	12/08 → 09/12	FCP1747	LUCAS/TRW				
116 d	85	12/08 → 09/12				FCP1806	LUCAS/TRW	
116 i	85	11/03 → 09/12	FCP1747	LUCAS/TRW				
116 i	85	11/03 → 09/12				FCP1806	LUCAS/TRW	
118 d	90	11/03 → 09/12	FCP1747	LUCAS/TRW				
118 d	90	11/03 → 09/12				FCP1806	LUCAS/TRW	
118i	95	07/04 → 09/12	FCP1747	LUCAS/TRW				
118i	95	07/04 → 09/12				FCP1806	LUCAS/TRW	
120 d	120	11/03 → 09/12	FCP1751	ATE				
120 d	120	11/03 → 09/12				FCP1806	LUCAS/TRW	
120 i	110	11/03 → 09/12	FCP1751	ATE				
120 i	110	11/03 → 09/12				FCP1807	ATE	
123 d	150	03/07 → 09/12	FCP1773	ATE				
123 d	150	03/07 → 09/12				FCP1807	ATE	
130 i	195	03/05 → 09/12	FCP1773	ATE				
130 i	195	03/05 → 09/12				FCP1807	ATE	
1 (E88)								
135i Cabriolet	225	01/08 →	FCP4218	BREMBO				
135i Cabriolet	225	01/08 →				FCP4217	BREMBO	
1 (F20)								
114 d	70	10/12 →	FCP4611	Brembo	For vehicles with sports package			
114 d	70	10/12 →	FCP4489	ATE				
114 d	70	10/12 →				FCP4663	Brembo	For vehicles with sports package
114 i	75	11/11 →	FCP4611	Brembo	For vehicles with sports package			
114 i	75	11/11 →	FCP4489	ATE				
114 i	75	11/11 →				FCP4663	Brembo	For vehicles with sports package
116 d	85	11/12 →	FCP4611	Brembo	For vehicles with sports package			
116 d	85	11/12 →	FCP4489	ATE				
116 d	85	11/12 →				FCP4663	Brembo	For vehicles with sports package
116 d	85	12/10 →	FCP4611	Brembo	For vehicles with sports package			
116 d	85	12/10 →	FCP4489	ATE				
116 d	85	12/10 →				FCP4663	Brembo	For vehicles with sports package
116 i	100	12/10 →	FCP4611	Brembo	For vehicles with sports package			

For material availability see page 16-18 / Per la disponibilità materiali vedere a pagina 16-18



KW



...BMW

...1 (F20)

					NOTE			NOTE
116 i	100	12/10 →	FCP4489	ATE				
116 i	100	12/10 →				FCP4663	Brembo	For vehicles with sports package
118 d	100	12/10 →	FCP4611	Brembo	For vehicles with sports package			
118 d	100	12/10 →	FCP4489	ATE				
118 d	100	12/10 →				FCP4663	Brembo	For vehicles with sports package
118 d	105	12/10 →	FCP4611	Brembo	For vehicles with sports package			
118 d	105	12/10 →	FCP4489	ATE				
118 d	105	12/10 →				FCP4663	Brembo	For vehicles with sports package
118 d	110	03/15 →	FCP4394	BOSCH	only for South Korea & North Korea vehicles			
118 d	110	03/15 →	FCP4489	ATE				
118 d	110	03/15 →	FCP4611	BREMBO				
118 d	110	03/15 →				FCP4663	BREMBO	
118 d xDrive	105	07/13 →	FCP4611	Brembo	For vehicles with sports package			
118 d xDrive	105	07/13 →	FCP4489	ATE				
118 d xDrive	105	07/13 →				FCP4663	BREMBO	For vehicles with sports package
118 d xDrive	110	03/15 →	FCP4489	ATE				
118 i	125	11/10 →	FCP4611	Brembo	For vehicles with sports package			
118 i	125	11/10 →	FCP4489	ATE				
118 i	125	11/10 →				FCP4663	Brembo	For vehicles with sports package
120 d	120	12/10 →	FCP4611	Brembo	For vehicles with sports package			
120 d	120	12/10 →	FCP4489	ATE				
120 d	120	12/10 →				FCP4663	Brembo	For vehicles with sports package
120 d	135	12/10 →	FCP4611	Brembo	For vehicles with sports package			
120 d	135	12/10 →	FCP4489	ATE				
120 d	135	12/10 →				FCP4663	Brembo	For vehicles with sports package
120 d	140	03/15 →	FCP4489	ATE				
120 d	147	01/11 →	FCP4489	ATE				
120 d xDrive	135	02/12 →	FCP4611	Brembo	For vehicles with sports package			
120 d xDrive	135	02/12 →	FCP4489	ATE				
120 d xDrive	135	02/12 →				FCP4663	Brembo	For vehicles with sports package
120 d xDrive	140	03/15 →	FCP4489	ATE				
120 d xDrive	147	01/11 →	FCP4489	ATE				
120 i	130	03/15 →	FCP4489	ATE				
125 d	155	08/11 →	FCP4611	Brembo	For vehicles with sports package			
125 d	155	08/11 →	FCP4394	BOSCH				
125 d	155	08/11 →	FCP4489	ATE				
125 d	155	08/11 →				FCP4663	Brembo	For vehicles with sports package
125 d	160	08/11 →	FCP4611	Brembo	For vehicles with sports package			
125 d	160	08/11 →	FCP4394	BOSCH				
125 d	160	08/11 →	FCP4489	ATE				
125 d	160	08/11 →				FCP4663	Brembo	For vehicles with sports package
125 i	160	08/11 →	FCP4611	Brembo	For vehicles with sports package			
125 i	160	08/11 →	FCP4394	BOSCH				
125 i	160	08/11 →	FCP4489	ATE				
125 i	160	08/11 →				FCP4663	Brembo	For vehicles with sports package
M 135 i	235	11/11 →	FCP4611	Brembo	For vehicles with sports package			
M 135 i	235	11/11 →	FCP4489	ATE				
M 135 i	235	11/11 →				FCP4663	Brembo	For vehicles with sports package
M 135 i xDrive	235	02/12 →	FCP4611	Brembo	For vehicles with sports package			
M 135 i xDrive	235	02/12 →	FCP4489	ATE				
M 135 i xDrive	235	02/12 →				FCP4663	Brembo	For vehicles with sports package

1 (F21)

114 d	70	07/12 →	FCP4611	Brembo	For vehicles with sports package			
114 d	70	07/12 →	FCP4489	ATE				
114 d	70	07/12 →				FCP4663	Brembo	For vehicles with sports package
114 i	75	12/11 →	FCP4611	Brembo	For vehicles with sports package			
114 i	75	12/11 →	FCP4489	ATE				
114 i	75	12/11 →				FCP4663	Brembo	For vehicles with sports package
116 d	85	12/11 →	FCP4611	Brembo	For vehicles with sports package			
116 d	85	12/11 →	FCP4489	ATE				
116 d	85	12/11 →				FCP4663	Brembo	For vehicles with sports package
116 d	85	01/12 →	FCP4611	Brembo	For vehicles with sports package			
116 d	85	01/12 →	FCP4489	ATE				
116 d	85	01/12 →				FCP4663	Brembo	For vehicles with sports package
116 i	100	12/11 →	FCP4611	Brembo	For vehicles with sports package			
116 i	100	12/11 →	FCP4489	ATE				
116 i	100	12/11 →				FCP4663	Brembo	For vehicles with sports package
118 d	100	12/11 →	FCP4611	Brembo	For vehicles with sports package			
118 d	100	12/11 →	FCP4489	ATE				
118 d	100	12/11 →				FCP4663	Brembo	For vehicles with sports package
118 d	105	12/11 →	FCP4611	Brembo	For vehicles with sports package			
118 d	105	12/11 →	FCP4489	ATE				
118 d	105	12/11 →				FCP4663	Brembo	For vehicles with sports package
118 d xDrive	105	05/13 →	FCP4611	Brembo	For vehicles with sports package			
118 d xDrive	105	05/13 →	FCP4489	ATE				
118 d xDrive	105	05/13 →				FCP4663	Brembo	For vehicles with sports package

For material availability see page 16-18 / Per la disponibilità materiali vedere a pagina 16-18



KW



BMW

...BMW					NOTE			NOTE
...1 (F21)								
118 d xDrive	110	03/15 →	FCP4489	ATE				
118 i	125	07/12 →	FCP4611	Brembo	For vehicles with sports package			
118 i	125	07/12 →	FCP4489	ATE				
118 i	125	07/12 →				FCP4663	Brembo	For vehicles with sports package
120 d	120	07/12 →	FCP4611	Brembo	For vehicles with sports package			
120 d	120	07/12 →	FCP4489	ATE				
120 d	120	07/12 →				FCP4663	Brembo	For vehicles with sports package
120 d	135	07/12 →	FCP4611	Brembo	For vehicles with sports package			
120 d	135	07/12 →	FCP4489	ATE				
120 d	135	07/12 →				FCP4663	Brembo	For vehicles with sports package
120 d	140	03/15 →	FCP4489	ATE				
120 d	147	01/12 →	FCP4489	ATE				
120 d xDrive	135	02/12 →	FCP4611	Brembo	For vehicles with sports package			
120 d xDrive	135	02/12 →	FCP4489	ATE				
120 d xDrive	135	02/12 →				FCP4663	Brembo	For vehicles with sports package
120 d xDrive	140	03/15 →	FCP4489	ATE				
120 d xDrive	147	01/12 →	FCP4489	ATE				
120 i	130	03/15 →	FCP4489	ATE				
125 d	155	12/11 →	FCP4611	Brembo	For vehicles with sports package			
125 d	155	12/11 →	FCP4394	BOSCH				
125 d	155	12/11 →	FCP4489	ATE				
125 d	155	12/11 →				FCP4663	Brembo	For vehicles with sports package
125 d	160	12/11 →	FCP4611	Brembo	For vehicles with sports package			
125 d	160	12/11 →	FCP4394	BOSCH				
125 d	160	12/11 →	FCP4489	ATE				
125 d	160	12/11 →				FCP4663	Brembo	For vehicles with sports package
125 i	160	12/11 →	FCP4611	Brembo	For vehicles with sports package			
125 i	160	12/11 →	FCP4394	BOSCH				
125 i	160	12/11 →	FCP4489	ATE				
125 i	160	12/11 →				FCP4663	Brembo	For vehicles with sports package
M 135 i	235	12/11 →	FCP4611	Brembo	For vehicles with sports package			
M 135 i	235	12/11 →	FCP4489	ATE				
M 135 i	235	12/11 →				FCP4663	Brembo	For vehicles with sports package
M 135 i xDrive	235	02/12 →	FCP4611	Brembo	For vehicles with sports package			
M 135 i xDrive	235	02/12 →	FCP4489	ATE				
M 135 i xDrive	235	02/12 →				FCP4663	Brembo	For vehicles with sports package
1500-2000								
1800 1.8 Ti / TiSA	66	01/63 → 09/71	FCP2	ATE				
2 Convertible (F23)								
220 d	120	11/14 →	FCP4394	BOSCH				
2 Coupe (F22, F87)								
218 d	105	01/14 →	FCP4611	Brembo	For vehicles with sports package			
218 d	105	01/14 →	FCP4489	ATE				
218 d	105	01/14 →				FCP4663	BREMBO	For vehicles with sports package
220 d	135	10/13 →	FCP4611	Brembo	For vehicles with sports package			
220 d	135	10/13 →	FCP4394	BOSCH				
220 d	135	10/13 →	FCP4489	ATE				
220 d	135	10/13 →				FCP4663	BREMBO	For vehicles with sports package
220 d	140	11/14 →	FCP4394	BOSCH				
220 d xDrive	120	03/15 →	FCP4394	BOSCH				
220 i	135	10/13 →	FCP4394	BOSCH				
225 d	160	01/14 →	FCP4611	Brembo	For vehicles with sports package			
225 d	160	01/14 →	FCP4489	ATE				
225 d	160	01/14 →				FCP4663	BREMBO	For vehicles with sports package
M 235 i	240	10/13 →	FCP4611	Brembo	For vehicles with sports package			
M 235 i	240	10/13 →	FCP4489	ATE				
M 235 i	240	10/13 →				FCP4663	Brembo	For vehicles with sports package
M 240 i	250	09/15 →	FCP4611	BREMBO				
M 240 i	250	09/15 →				FCP4663	BREMBO	
M2	272	11/15 →	FCP4611	BREMBO	For vehicles without ceramic discs			
M2	272	11/15 →	FCP4489	ATE				
M2	272	11/15 →				FCP4663	BREMBO	For vehicles without ceramic discs
2500-3.3 (E3)								
2500 CS, Automatic	110	01/68 → 12/76	FCP399	ATE				
2800	125	01/68 → 12/76	FCP399	ATE				
3.0	132, 143	01/71 → 12/77	FCP399	ATE				
3.2	140, 146	01/71 → 12/77	FCP399	ATE				

For material availability see page 16-18 / Per la disponibilità materiali vedere a pagina 16-18

1046



KW



...BMW

3

1.8 16V M3	100	01/86 → 12/93	FCP256	ATE			
1.8 16V M3	100	01/86 → 12/93			FCP578	ATE	

3 (E21)

315	55	03/81 → 03/84	FCP116	ATE			
320	80	08/75 → 08/77	FCP116	ATE			
320i	92	07/75 → 08/82	FCP116	ATE			
323i	105	01/78 → 10/82	FCP116	ATE			

3 (E30)

316 / 316i / 316i 1.8	66	11/82 → 12/91			FCP296	ATE	
316 / 316i / 316i 1.8	74	11/82 → 12/91			FCP296	ATE	
316 / 316i / 316i 1.8	75	11/82 → 12/91			FCP296	ATE	
318i	66	02/82 → 06/91	FCP660	LUCAS/TRW			
318i	66	02/82 → 06/91			FCP296	ATE	
318i	77	02/82 → 06/91	FCP660	LUCAS/TRW			
318i	77	02/82 → 06/91			FCP296	ATE	
318i	85	02/82 → 06/91	FCP660	LUCAS/TRW			
318i	85	02/82 → 06/91			FCP296	ATE	
318i (E30)	66	11/82 → 08/91	FCP660	LUCAS/TRW			
318i (E30)	66	11/82 → 08/91			FCP296	ATE	
318i (E30)	77	11/82 → 08/91	FCP660	LUCAS/TRW			
318i (E30)	77	11/82 → 08/91			FCP296	ATE	
318is	75	11/82 → 08/91	FCP660	LUCAS/TRW			
318is	75	11/82 → 08/91			FCP296	ATE	
320 i	110	12/85 → 06/90	FCP660	LUCAS/TRW			
320 i	110	12/85 → 06/90			FCP296	ATE	
320 i	92	09/82 → 12/91	FCP660	LUCAS/TRW			
320 i	92	09/82 → 12/91			FCP296	ATE	
320 i	95	12/85 → 06/91	FCP660	LUCAS/TRW			
320 i	95	12/85 → 06/91			FCP296	ATE	
320 is	141	05/88 → 12/90	FCP660	LUCAS/TRW			
320 is	141	05/88 → 12/90			FCP296	ATE	
323i	102, 110	10/82 → 12/91	FCP660	LUCAS/TRW			
323i	102, 110	10/82 → 12/91			FCP296	ATE	
324d	63	01/85 → 08/91	FCP660	LUCAS/TRW			
324d	63	01/85 → 08/91			FCP296	ATE	
324td	85	01/87 → 08/91	FCP660	LUCAS/TRW			
324td	85	01/87 → 08/91			FCP296	ATE	
325e 2.7	90, 95	09/83 → 12/88	FCP660	LUCAS/TRW			
325e 2.7	90, 95	09/83 → 12/88			FCP296	ATE	
325i /325 iX	125, 126	09/83 → 08/91	FCP660	LUCAS/TRW			
325i /325 iX	125, 126	09/83 → 08/91			FCP296	ATE	
M3 2.3	143	07/86 → 06/91	FCP256	ATE			
M3 2.3	143	07/86 → 06/91			FCP578	ATE	
M3 2.3	147	02/87 → 05/89	FCP256	ATE			
M3 2.3	147	02/87 → 05/89			FCP578	ATE	
M3 2.3	158	07/85 → 06/91	FCP256	ATE			
M3 2.3	158	07/85 → 06/91			FCP578	ATE	

3 (E36)

3.0 3/C 24V M3	210, 286	09/90 → 03/95	FCP779	ATE			
3.0 3/C 24V M3	210, 286	09/90 → 03/95			FCP578	ATE	
3.2 3/C 24V M3	236	09/90 → 03/95	FCP779	ATE			
3.2 3/C 24V M3	236	09/90 → 03/95			FCP578	ATE	
3.2 i 3/C 24V M3	236	04/95 → 04/99	FCP779	ATE			
3.2 i 3/C 24V M3	236	04/95 → 04/99			FCP578	ATE	
316i	73, 75	09/90 → 12/98	FCP725	ATE			
316i	73, 75	09/90 → 12/98			FCP850	ATE	
316i	74	09/90 → 09/93	FCP725	ATE			
316i	74	09/90 → 09/93			FCP850	ATE	ABS
316i Compact	75	07/93 → 02/98	FCP725	ATE			
316i Compact	75	07/93 → 02/98			FCP850	ATE	
318 i	83	12/90 → 10/93	FCP725	ATE			
318 i	83	12/90 → 10/93			FCP850	ATE	
318 i	85	10/93 → 02/98	FCP725	ATE			
318 i	85	10/93 → 02/98			FCP850	ATE	
318 is	103	03/93 → 02/98	FCP725	ATE			
318 is	103	03/93 → 02/98			FCP850	ATE	
318 is	103	09/95 → 02/98	FCP725	ATE			
318 is	103	09/95 → 02/98			FCP850	ATE	
318i (E36)	66	08/94 → 01/98	FCP725	ATE			
318i (E36)	66	08/94 → 01/98			FCP850	ATE	ABS
320i	110	09/90 → 01/98	FCP725	ATE			
320i	110	09/90 → 01/98			FCP850	ATE	
323i 2.5	125	03/95 → 02/98	FCP1300	ATE			
323i 2.5	125	03/95 → 02/98			FCP850	ATE	

For material availability see page 16-18 / Per la disponibilità materiali vedere a pagina 16-18



KW



...BMW					NOTE			NOTE
...3 (E36)								
325i	141	08/90 → 03/95	FCP725	ATE				
325i	141	08/90 → 03/95				FCP850	ATE	
325tds	85, 105	09/91 → 02/98	FCP725	ATE				
325tds	85, 105	09/91 → 02/98				FCP850	ATE	
328i	143	01/95 → 02/98	FCP725	ATE				
328i	143	01/95 → 02/98				FCP850	ATE	
3 (E40)								
3.2 i M3	236	04/95 → 04/99	FCP779	ATE				
3.2 i M3	236	04/95 → 04/99				FCP857	ATE	
3 (E46)								
3.2 Coupe M3	252	01/00 → 12/06	FCP779	ATE				
3.2 Coupe M3	252	06/00 → 12/06				FCP1483	ATE	
318 d	85	09/01 → 03/03	FCP1300	ATE				
318 d	85	09/01 → 03/03				FCP1301	ATE	
318 d	85	03/03 → 02/05	FCP1300	ATE				
318 d	85	03/03 → 02/05				FCP1301	ATE	
318i	105	02/98 → 02/05	FCP1300	ATE				
318i	105	02/98 → 02/05				FCP1301	ATE	
318i	77	02/98 → 02/05	FCP1300	ATE				
318i	77	02/98 → 02/05				FCP1301	ATE	
318i	87	02/98 → 02/05	FCP1300	ATE				
318i	87	02/98 → 02/05				FCP1301	ATE	
320 d	100	04/98 → 09/01	FCP1300	ATE				
320 d	100	04/98 → 09/01				FCP1301	ATE	
320 d	110	09/01 → 02/05	FCP1300	ATE				
320 d	110	09/01 → 02/05				FCP1301	ATE	
320i	110, 125	03/98 → 02/05	FCP1300	ATE				
320i	110, 125	03/98 → 02/05				FCP1301	ATE	
320Tdi 24V	100	02/98 →	FCP1300	ATE				
320Tdi 24V	100	02/98 →				FCP1301	ATE	
323i	125	03/98 → 09/00	FCP1300	ATE				
323i	125	03/98 → 09/00				FCP1301	ATE	
328i	142	02/98 → 06/00	FCP1300	ATE				
328i	142	02/98 → 06/00				FCP1301	ATE	
330d / 330Xd	135, 150	10/99 → 02/05	FCP1073	ATE				
330d / 330Xd	135, 150	10/99 → 02/05				FCP1483	ATE	
330i	170	06/00 → 02/05	FCP1073	ATE				
330i	170	06/00 → 02/05				FCP1483	ATE	
CSL Coupe M3	265	03/03 → 07/06	FCP779	ATE				
CSL Coupe M3	265	03/03 → 07/06				FCP1483	ATE	
3 (E90)								
325d 3.0	150	03/10 →	FCP1773	ATE				
325d 3.0	150	03/10 →				FCP1808	ATE	
325i 2.5	160	03/05 → 12/11	FCP4191	ATE				
325i 2.5	160	03/05 → 12/11				FCP1807	ATE	
325i 2.5 Xi	160	01/05 → 12/11	FCP1773	ATE				
325i 2.5 Xi	160	01/05 → 12/11				FCP1807	ATE	
325i 2.5 Xi	160	10/05 → 08/08	FCP4191	ATE				
325i 2.5 Xi	160	10/05 → 08/08				FCP1807	ATE	
325i 3.0	155	06/06 → 12/11	FCP4191	ATE				
325i 3.0	155	06/06 → 12/11				FCP1807	ATE	
325i xDrive 2.5	160	09/08 → 12/11	FCP4191	ATE				
325i xDrive 2.5	160	09/08 → 12/11				FCP1807	ATE	
328i 3.0	172	03/07 → 12/11	FCP4191	ATE				
328i 3.0	172	03/07 → 12/11				FCP1807	ATE	
330d 3.0	170	03/05 → 09/07	FCP1773	ATE				
330d 3.0	170	03/05 → 09/07				FCP1808	ATE	
330d 3.0	180	09/08 →	FCP1773	ATE				
330d 3.0	180	09/08 →				FCP1808	ATE	
330d xDrive 3.0	180	09/09 →	FCP1773	ATE				
330d xDrive 3.0	180	09/09 →				FCP1808	ATE	
330i 3.0	190	01/05 → 12/11	FCP1773	ATE				
330i 3.0	190	01/05 → 12/11				FCP1808	ATE	
330i 3.0 Xi	190	01/05 → 12/11	FCP1773	ATE				
330i 3.0 Xi	190	10/05 → 06/07	FCP1773	ATE				
330i 3.0 Xi	190	10/05 → 06/07				FCP1808	ATE	
330i xDrive 3.0	200	09/08 →	FCP1773	ATE				
330i xDrive 3.0	200	09/08 →				FCP1808	ATE	
335i	225	09/06 → 12/11	FCP1628	ATE				
335i	225	09/06 → 12/11				FCP1808	ATE	

For material availability see page 16-18 / Per la disponibilità materiali vedere a pagina 16-18



KW



...BMW

3 (E91)

					NOTE			NOTE
318d Touring 2.0	100	09/07 →	FCP4191	ATE				
318d Touring 2.0	100	09/07 →				FCP1807	ATE	
318d Touring 2.0	105	06/07 →	FCP4191	ATE				
318d Touring 2.0	105	06/07 →				FCP1807	ATE	
320d xDrive Touring 2.0	130	09/08 →	FCP4191	ATE				
320d xDrive Touring 2.0	130	09/08 →				FCP1807	ATE	
320i Touring 2.0	115	06/07 →	FCP4191	ATE				
320i Touring 2.0	115	06/07 →				FCP1807	ATE	
320i Touring 2.0	120	06/07 → 12/11	FCP4191	ATE				
320i Touring 2.0	120	06/07 →	FCP4191	ATE				
320i Touring 2.0	120	06/07 → 12/11				FCP1807	ATE	
320i Touring 2.0	120	06/07 →				FCP1807	ATE	
323i Touring 2.5	130	04/06 → 06/07	FCP4191	ATE				
323i Touring 2.5	130	04/06 → 06/07				FCP1807	ATE	
325d Touring 3.0	150	04/10 →	FCP1773	ATE				
325d Touring 3.0	150	04/10 →				FCP1808	ATE	
325i Touring 2.5	160	12/04 → 07/07	FCP1773	ATE				
325i Touring 2.5	160	12/04 → 12/10				FCP1808	ATE	For increased payload
325i Touring 2.5	160	12/04 → 12/10				FCP1807	ATE	
325i Touring 2.5	160	08/07 → 12/10	FCP4191	ATE				
325i Touring 2.5 Xi	160	09/05 → 08/11	FCP4191	ATE	For vehicles without increased axle load			
325i Touring 2.5 Xi	160	09/05 → 08/11	FCP1773	ATE				
325i Touring 2.5 Xi	160	09/05 → 08/11				FCP1807	ATE	
325i Touring 2.5 Xi	160	09/05 → 08/11				FCP1808	ATE	For increased payload
325i Touring 3.0	155	06/07 →	FCP4191	ATE				
325i Touring 3.0	155	06/07 →				FCP1807	ATE	
325i Touring 3.0	160	06/07 → 06/12	FCP4191	ATE				
325i Touring 3.0	160	06/07 → 06/12				FCP1807	ATE	
325i xDrive Touring 3.0	160	09/08 →	FCP1773	ATE				
325i xDrive Touring 3.0	160	09/08 →	FCP4191	ATE				
325i xDrive Touring 3.0	160	09/08 →				FCP1808	ATE	
325i xDrive Touring 3.0	160	09/08 →				FCP1807	ATE	
330d Touring 3.0	180	09/09 →	FCP1773	ATE				
330d Touring 3.0	180	09/09 →				FCP1808	ATE	
330d xDrive Touring 3.0	180	09/08 →	FCP1773	ATE				
330d xDrive Touring 3.0	180	09/08 →				FCP1808	ATE	
330i Touring 3.0	190	09/05 →	FCP1628	ATE				
330i Touring 3.0	190	11/05 →	FCP1773	ATE				
330i Touring 3.0	190	11/05 →				FCP1808	ATE	
330i Touring 3.0 Xi	190	09/05 →	FCP1628	ATE				
330i Touring 3.0 Xi	190	10/05 → 08/07	FCP1773	ATE				
330i Touring 3.0 Xi	190	10/05 → 08/07				FCP1808	ATE	
330i xDrive Touring 3.0	200	09/08 →	FCP1773	ATE				
330i xDrive Touring 3.0	200	09/08 →				FCP1808	ATE	

3 (E92)

320d Coupe 2.0	130	02/07 → 12/11	FCP4191	ATE				
320d Coupe 2.0	130	02/07 → 12/11				FCP1807	ATE	
320d Coupe 2.0	135	03/10 →	FCP4191	ATE				
320d Coupe 2.0	135	03/10 →				FCP1807	ATE	
320d Coupe 2.0 Xd	130	03/07 → 08/08	FCP4191	ATE				
320d Coupe 2.0 Xd	130	03/07 → 08/08				FCP1807	ATE	
320d xDrive Coupe 2.0	120	09/08 →	FCP4191	ATE				
320d xDrive Coupe 2.0	120	09/08 →				FCP1807	ATE	
320d xDrive Coupe 2.0	130	09/08 → 07/11	FCP4191	ATE				
320d xDrive Coupe 2.0	130	09/08 → 07/11				FCP1807	ATE	
320d xDrive Coupe 2.0	135	03/10 →	FCP4191	ATE				
320d xDrive Coupe 2.0	135	03/10 →				FCP1807	ATE	
323i Coupe 2.5	130	10/07 → 08/08	FCP4191	ATE				
323i Coupe 2.5	130	10/07 → 08/08				FCP1807	ATE	
325d Coupe 3.0	145	09/06 → 03/10	FCP1773	ATE				
325d Coupe 3.0	145	09/06 → 03/10				FCP1808	ATE	
325d Coupe 3.0	150	04/10 →	FCP4218	BREMBO	Sports package			
325d Coupe 3.0	150	04/10 →	FCP1773	ATE				
325d Coupe 3.0	150	04/10 →				FCP1808	ATE	
325i Coupe 2.5 Xi	160	09/06 →	FCP1773	ATE				
325i Coupe 2.5 Xi	160	09/06 →				FCP1807	ATE	
325i Coupe 2.5 Xi	160	10/07 → 09/08	FCP4191	ATE				
325i Coupe 2.5 Xi	160	10/07 → 09/08				FCP1807	ATE	
325i xDrive Coupe 2.5	160	03/10 →	FCP4191	ATE				
325i xDrive Coupe 2.5	160	03/10 →				FCP1807	ATE	
330d Coupe 3.0	180	09/08 →	FCP1773	ATE				
330d Coupe 3.0	180	09/08 →				FCP1808	ATE	
330d xDrive Coupe 3.0	180	09/08 →	FCP1773	ATE				
330d xDrive Coupe 3.0	180	09/08 →				FCP1808	ATE	
330i Coupe 3.0	190	08/06 →	FCP1773	ATE				
330i Coupe 3.0	190	08/06 →				FCP1808	ATE	

For material availability see page 16-18 / Per la disponibilità materiali vedere a pagina 16-18



KW



...BMW

...3 (E92)

Model	Power	Start	End	Part	Material	Notes	Part	Material	Notes
330i Coupe 3.0	190	09/06	→	FCP1773	ATE				
330i Coupe 3.0 Xi	190	08/06	→ 09/08	FCP1773	ATE				
330i Coupe 3.0 Xi	190	08/06	→ 09/08				FCP1808	ATE	
330i Coupe 3.0 Xi	190	09/06	→	FCP1773	ATE				
330i xDrive Coupe 3.0	200	09/08	→	FCP1773	ATE				
330i xDrive Coupe 3.0	200	09/08	→				FCP1808	ATE	
335d Coupe 3.0	210	09/06	→				FCP1808	ATE	
All 3 Coupe M3	309	03/07	→	FCP1628	ATE				
All 3 Coupe M3	309	03/07	→				FCP1672	ATE	

3 (E93)

320d Cabrio 2.0	120	01/08	→ 02/10	FCP4191	ATE				
320d Cabrio 2.0	120	01/08	→ 02/10				FCP1807	ATE	
320d Cabrio 2.0	130	08/06	→ 12/11	FCP4191	ATE				
320d Cabrio 2.0	130	08/06	→ 12/11				FCP1807	ATE	
320d Cabrio 2.0	135	03/10	→	FCP4191	ATE				
320d Cabrio 2.0	135	03/10	→				FCP1807	ATE	
320i Cabrio 2.0	110	08/06	→ 08/07	FCP4191	ATE				
320i Cabrio 2.0	110	08/06	→ 08/07				FCP1807	ATE	
320i Cabrio 2.0	115	07/07	→	FCP4191	ATE				
320i Cabrio 2.0	115	07/07	→				FCP1807	ATE	
320i Cabrio 2.0	120	07/07	→ 03/10	FCP4191	ATE				
320i Cabrio 2.0	120	07/07	→ 03/10				FCP1807	ATE	
320i Cabrio 2.0	125	03/07	→	FCP4191	ATE				
320i Cabrio 2.0	125	03/07	→				FCP1807	ATE	
325d Cabrio 3.0	145	07/07	→ 02/10	FCP4218	BREMBO	Sports package			
325d Cabrio 3.0	145	07/07	→ 02/10	FCP1773	ATE				
325d Cabrio 3.0	145	07/07	→ 02/10				FCP1808	ATE	
325i Cabrio 2.5	160	08/06	→	FCP4191	ATE				
325i Cabrio 2.5	160	08/06	→				FCP1807	ATE	
330d Cabrio 3.0	180	01/09	→	FCP1773	ATE				
330d Cabrio 3.0	180	01/09	→				FCP1808	ATE	
330i Cabrio 3.0	200	10/09	→	FCP1773	ATE				
330i Cabrio 3.0	200	10/09	→				FCP1808	ATE	

3 (F30, F35, F80)

325Li	225	07/12	→	FCP4611	Brembo	For vehicles with sports package			
335 i	240	10/11	→ 07/13	FCP4611	BREMBO	For Vehicles with Sport package			
335 i	250	07/13	→	FCP4611	BREMBO	For Vehicles with Sport package			
335 i xDrive	240	10/11	→ 07/13	FCP4611	BREMBO	For Vehicles with Sport package			
335 i xDrive	250	07/13	→	FCP4611	BREMBO	For Vehicles with Sport package			
340 i	265	10/15	→	FCP4611	BREMBO				
340 i xDrive	265	10/15	→	FCP4611	BREMBO				
M3	317	01/14	→	FCP4611	BREMBO	For vehicles without ceramic discs			
M3	317	01/14	→				FCP4663	BREMBO	For vehicles without ceramic discs

3 (F30, F80)

316 d	85	02/12	→	FCP4611	Brembo	For vehicles with sports package			
316 d	85	02/12	→	FCP4489	ATE				
316 d	85	02/12	→				FCP4663	Brembo	For vehicles with sports package
316 i	100	10/12	→	FCP4611	Brembo	For vehicles with sports package			
316 i	100	10/12	→	FCP4489	ATE				
316 i	100	10/12	→				FCP4663	Brembo	For vehicles with sports package
318 d	100	02/12	→	FCP4611	Brembo	For vehicles with sports package			
318 d	100	02/12	→	FCP4489	ATE				
318 d	100	02/12	→				FCP4663	BREMBO	For vehicles with sports package
318 d	105	02/12	→	FCP4611	Brembo	For vehicles with sports package			
318 d	105	02/12	→	FCP4489	ATE				
318 d	105	02/12	→				FCP4663	Brembo	For vehicles with sports package
318 d	110	07/15	→	FCP4489	ATE				
318 d xDrive	105	11/12	→	FCP4611	Brembo	For vehicles with sports package			
318 d xDrive	105	11/12	→	FCP4489	ATE				
318 d xDrive	105	11/12	→				FCP4663	Brembo	For vehicles with sports package
318 i	100	07/15	→	FCP4489	ATE				
320 d	135	10/11	→	FCP4611	Brembo	For vehicles with sports package			
320 d	135	10/11	→ 07/15	FCP4394	BOSCH				
320 d	135	10/11	→ 07/15	FCP4489	ATE				
320 d	135	10/11	→				FCP4663	Brembo	For vehicles with sports package
320 d	140	07/15	→	FCP4489	ATE				
320 d Efficient Dynamics	120	10/11	→	FCP4611	Brembo	For vehicles with sports package			
320 d Efficient Dynamics	120	10/11	→	FCP4394	BOSCH				
320 d Efficient Dynamics	120	10/11	→	FCP4489	ATE				
320 d Efficient Dynamics	120	10/11	→				FCP4663	Brembo	For vehicles with sports package
320 d xDrive	120	05/12	→	FCP4611	Brembo	For vehicles with sports package			
320 d xDrive	120	05/12	→	FCP4394	BOSCH				
320 d xDrive	120	05/12	→				FCP4663	BREMBO	For vehicles with sports package

For material availability see page 16-18 / Per la disponibilità materiali vedere a pagina 16-18

1050

FERODO

RACING

Updated on 17th Aug 2018



KW



...BMW

...3 (F30, F80)

					NOTE			NOTE
320 d xDrive	135	10/11 → 07/15	FCP4611	Brembo	For vehicles with sports package			
320 d xDrive	135	10/11 → 07/15	FCP4394	BOSCH				
320 d xDrive	135	10/11 → 07/15	FCP4489	ATE				
320 d xDrive	135	10/11 → 07/15				FCP4663	Brembo	For vehicles with sports package
320 d xDrive	140	07/15 →	FCP4489	ATE				
320 i	135	02/12 →	FCP4611	Brembo	For vehicles with sports package			
320 i	135	02/12 →	FCP4394	BOSCH				
320 i	135	02/12 →	FCP4489	ATE				
320 i	135	02/12 →				FCP4663	Brembo	For vehicles with sports package
320 i	135	07/15 →	FCP4489	ATE				
320 i Efficient Dynamics	125	02/12 →	FCP4611	Brembo	For vehicles with sports package			
320 i Efficient Dynamics	125	02/12 →	FCP4489	ATE				
320 i Efficient Dynamics	125	02/12 →				FCP4663	Brembo	For vehicles with sports package
320 i xDrive	135	11/11 →	FCP4611	Brembo	For vehicles with sports package			
320 i xDrive	135	11/11 →	FCP4394	BOSCH				
320 i xDrive	135	11/11 →	FCP4489	ATE				
320 i xDrive	135	11/11 →				FCP4663	Brembo	For vehicles with sports package
320 i xDrive	135	07/15 →	FCP4489	ATE				
325 d	155	10/11 →	FCP4394	BOSCH				
325 d	155	10/11 →	FCP4611	BREMBO	For Vehicles with Sport package			
325 d	160	10/11 →	FCP4611	Brembo	For vehicles with sports package			
325 d	160	10/11 →	FCP4394	BOSCH				
325 d	160	10/11 →	FCP4489	ATE				
325 d	160	10/11 →				FCP4663	Brembo	For vehicles with sports package
328 i	180	10/11 →	FCP4611	Brembo	For vehicles with sports package			
328 i	180	10/11 →	FCP4394	BOSCH				
328 i	180	10/11 →	FCP4489	ATE				
328 i	180	10/11 →				FCP4663	Brembo	For vehicles with sports package
328 i xDrive	180	10/11 →	FCP4611	Brembo	For vehicles with sports package			
328 i xDrive	180	10/11 →	FCP4394	BOSCH				
328 i xDrive	180	10/11 →	FCP4489	ATE				
328 i xDrive	180	10/11 →				FCP4663	Brembo	For vehicles with sports package
330 d	190	01/12 →	FCP4611	Brembo	For vehicles with sports package			
330 d	190	01/12 →	FCP4394	BOSCH				
330 d	190	01/12 →	FCP4489	ATE				
330 d	190	01/12 →				FCP4663	Brembo	For vehicles with sports package
330 d	210	09/15 →	FCP4394	BOSCH				
330 d	210	09/15 →	FCP4611	BREMBO	For Vehicles with Sport package			
330 d xDrive	190	03/13 →	FCP4611	Brembo	For vehicles with sports package			
330 d xDrive	190	03/13 →	FCP4394	BOSCH				
330 d xDrive	190	03/13 →	FCP4489	ATE				
330 d xDrive	190	03/13 →				FCP4663	Brembo	For vehicles with sports package
330 d xDrive	210	09/15 →	FCP4394	BOSCH				
330 e	185	01/16 →	FCP4394	BOSCH				
335 d xDrive	230	07/13 →	FCP4611	Brembo	For vehicles with sports package			
335 d xDrive	230	07/13 →	FCP4489	ATE				
335 d xDrive	230	07/13 →				FCP4663	Brembo	For vehicles with sports package
335 i	225	10/11 →	FCP4611	Brembo	For vehicles with sports package			
335 i	225	10/11 →	FCP4489	ATE				
335 i	225	10/11 →				FCP4663	Brembo	For vehicles with sports package
335 i xDrive	225	10/11 →	FCP4611	Brembo	For vehicles with sports package			
335 i xDrive	225	10/11 →	FCP4489	ATE				
335 i xDrive	225	10/11 →				FCP4663	Brembo	For vehicles with sports package
ActiveHybrid	225	07/12 →	FCP4611	Brembo	For vehicles with sports package			
ActiveHybrid	225	07/12 →	FCP4489	ATE				
ActiveHybrid	225	07/12 →				FCP4663	Brembo	For vehicles with sports package
ActiveHybrid	250	01/12 →	FCP4611	Brembo	For vehicles with sports package			
ActiveHybrid	250	01/12 →	FCP4489	ATE				
ActiveHybrid	250	01/12 →				FCP4663	Brembo	For vehicles with sports package

3 (F30,F80)

M3	331	03/16 →	FCP4611	BREMBO	For vehicles without ceramic discs			
M3	331	03/16 →				FCP4663	TEVES	For vehicles without ceramic discs

3 Compact (E36)

318Ti	103	11/94 → 08/00	FCP725	ATE				
318Ti	103	11/94 → 08/00				FCP850	ATE	
323Ti	125	05/97 → 08/00	FCP725	ATE				
323Ti	125	05/97 → 08/00				FCP850	ATE	

3 Compact (E46)

318Ti	105	03/93 → 02/05	FCP725	ATE				
318Ti	105	03/93 → 02/05				FCP1301	ATE	

For material availability see page 16-18 / Per la disponibilità materiali vedere a pagina 16-18



KW



...BMW

3 Convertible (E30)

					NOTE			NOTE
320 i	95	04/86 → 10/93	FCP660	LUCAS/TRW				
320 i	95	04/86 → 10/93				FCP296	ATE	
M3 2.3	143	06/88 → 06/91	FCP256	ATE				
M3 2.3	143	06/88 → 06/91				FCP578	ATE	

3 Convertible (E46)

M3 3.2	252	04/01 → 12/07	FCP779	ATE				
M3 3.2	252	04/01 → 12/07				FCP1483	ATE	

3 Convertible (E93)

325 i	155	10/06 →	FCP1063	LUCAS/TRW				
330 i	190	03/07 →	FCP1063	LUCAS/TRW				
335 i	225	03/07 →	FCP1628	ATE				
335 i	225	03/07 →				FCP1808	ATE	

3 Coupe (E46)

318Ci	87, 105	11/99 →	FCP1300	ATE				
318Ci	87, 105	11/99 →				FCP1301	ATE	
320Ci /323Ci	110, 125	04/99 →	FCP1300	ATE				
320Ci /323Ci	110, 125	04/99 →				FCP1301	ATE	
325Ti	141	06/01 → 02/05	FCP1300	ATE				
325Ti	141	06/01 → 02/05				FCP1301	ATE	
328i Coupe'	142	04/98 → 06/00	FCP1300	ATE				
328i Coupe'	142	04/98 → 06/00				FCP1301	ATE	
330Cd	150	03/03 →	FCP1073	ATE				
330Cd	150	03/03 →				FCP1483	ATE	
330Ci	170	06/00 →				FCP1483	ATE	

3 Coupe (E92)

325i	160	09/06 →	FCP1773	ATE				
325i	160	09/06 →				FCP1807	ATE	
330i	200	09/06 →	FCP1773	ATE				
330i	200	03/07 →	FCP4218	BREMBO				
330i	200	03/07 →				FCP1808	ATE	
330i	200	10/09 →	FCP1773	ATE				
330i	200	10/09 →				FCP1808	ATE	
330xi	200	09/06 →	FCP1773	ATE				
330xi	200	03/07 → 08/09	FCP1773	ATE				
330xi	200	03/07 → 08/09				FCP1808	ATE	
335 i	225	11/05 → 12/12	FCP1628	ATE				
335 i	225	11/05 → 12/12				FCP1808	ATE	

3 Gran Turismo (F34)

318 d	100	03/13 →	FCP4489	ATE				
318 d	105	03/13 →	FCP4611	Brembo	For vehicles with sports package			
318 d	105	03/13 →	FCP4489	ATE				
318 d	105	03/13 →				FCP4663	Brembo	For vehicles with sports package
318 d	110	07/15 →	FCP4489	ATE				
320 d	120	03/13 →	FCP4394	BOSCH				
320 d	135	03/13 →	FCP4611	Brembo	For vehicles with sports package			
320 d	135	03/13 → 07/15	FCP4394	BOSCH				
320 d	135	03/13 → 07/15	FCP4489	ATE				
320 d	135	03/13 →				FCP4663	Brembo	For vehicles with sports package
320 d xDrive	120	03/13 →	FCP4394	BOSCH				
320 d xDrive	135	03/13 →	FCP4611	Brembo	For vehicles with sports package			
320 d xDrive	135	03/13 → 07/15	FCP4394	BOSCH				
320 d xDrive	135	03/13 → 07/15	FCP4489	ATE				
320 d xDrive	135	03/13 →				FCP4663	Brembo	For vehicles with sports package
320 d xDrive	140	07/15 →	FCP4394	BOSCH				
320 d xDrive	147	05/13 →	FCP4611	Brembo	For vehicles with sports package			
320 d xDrive	147	05/13 →				FCP4663	Brembo	For vehicles with sports package
320 i	120	03/13 →	FCP4489	ATE				
320 i	135	03/13 →	FCP4611	Brembo	For vehicles with sports package			
320 i	135	03/13 →	FCP4489	ATE				
320 i	135	03/13 →				FCP4663	Brembo	For vehicles with sports package
320 i xDrive	120	03/13 →	FCP4489	ATE				
320 i xDrive	135	03/13 →	FCP4611	Brembo	For vehicles with sports package			
320 i xDrive	135	03/13 →	FCP4489	ATE				
320 i xDrive	135	03/13 →				FCP4663	Brembo	For vehicles with sports package
325 d	155	07/13 →	FCP4394	BOSCH				
325 d	155	07/13 →	FCP4611	BREMBO	For Vehicles with Sport package			
325 d	160	03/13 →	FCP4611	Brembo	For vehicles with sports package			
325 d	160	03/13 →	FCP4394	BOSCH				
325 d	160	03/13 →				FCP4663	Brembo	For vehicles with sports package
328 i	180	03/13 →	FCP4611	Brembo	For vehicles with sports package			
328 i	180	03/13 →	FCP4394	BOSCH				

For material availability see page 16-18 / Per la disponibilità materiali vedere a pagina 16-18



KW



...BMW

...3 Gran Turismo (F34)

					NOTE			NOTE
328 i	180	03/13 →	FCP4611	Brembo		FCP4663	Brembo	For vehicles with sports package
328 i xDrive	180	03/13 →	FCP4611	Brembo	For vehicles with sports package			
328 i xDrive	180	03/13 →	FCP4394	BOSCH				
328 i xDrive	180	03/13 →				FCP4663	Brembo	For vehicles with sports package
330 d	190	01/14 →	FCP4394	BOSCH				
330 d	190	01/14 →	FCP4611	BREMBO	For Vehicles with Sport package			
330 d	210	09/15 →	FCP4394	BOSCH				
330 d	210	09/15 →	FCP4611	BREMBO	For Vehicles with Sport package			
330 d xDrive	190	01/14 →	FCP4394	BOSCH				
330 d xDrive	190	01/14 →	FCP4611	BREMBO	For Vehicles with Sport package			
330 d xDrive	210	09/15 →	FCP4394	BOSCH				
335 d xDrive	230	01/14 →	FCP4611	Brembo	For vehicles with sports package			
335 d xDrive	230	01/14 →				FCP4663	BREMBO	For vehicles with sports package
335 i	225	03/13 →	FCP4611	Brembo	For vehicles with sports package			
335 i	225	03/13 →	FCP4489	ATE				
335 i	225	03/13 →				FCP4663	Brembo	For vehicles with sports package
335 i	240	03/13 → 03/14	FCP4611	BREMBO	For Vehicles with Sport package			
335 i	250	07/13 →	FCP4611	BREMBO				
335 i xDrive	225	03/13 →	FCP4611	Brembo	For vehicles with sports package			
335 i xDrive	225	03/13 →	FCP4489	ATE				
335 i xDrive	225	03/13 →				FCP4663	Brembo	For vehicles with sports package
335 i xDrive	240	03/13 → 03/14	FCP4611	BREMBO				
335 i xDrive	250	03/14 →	FCP4611	BREMBO				

3 Saloon (E90)

318d	100	07/07 → 12/11	FCP1773	ATE				
318d	100	07/07 → 12/11				FCP1807	ATE	Susp. Sport
318d	105	09/05 → 12/11	FCP1751	ATE				
318d	105	09/05 → 12/11				FCP1807	ATE	
318i	95	09/05 → 03/07	FCP1751	ATE				
318i	95	09/05 → 03/07				FCP1806	ATE	
318i	95	09/07 → 12/11	FCP1773	ATE				
318i	95	09/07 → 12/11				FCP1807	ATE	Susp. Sport
320d	120	01/05 →	FCP1773	ATE				
320d	120	01/05 →				FCP1807	ATE	
320d	120	03/07 →	FCP4191	ATE				
320d	120	03/07 →				FCP1807	ATE	
320i	110	01/05 → 03/07	FCP1751	ATE				
320i	110	01/05 → 03/07				FCP1806	ATE	
320i	115	03/07 → 12/11	FCP1773	ATE				
320i	115	03/07 → 12/11				FCP1807	ATE	Susp. Sport
320i	125	03/07 → 12/11	FCP1773	ATE				
320i	125	03/07 → 12/11				FCP1807	ATE	Susp. Sport
320si	127	05/06 →	FCP1773	ATE				
320si	127	05/06 →				FCP1807	ATE	
325d	145	09/06 →	FCP1773	ATE				
325d	145	09/06 →	FCP4218	BREMBO				
325d	145	09/06 →	FCP1773	ATE				
325d	145	09/06 →				FCP1807	ATE	
325d	145	09/06 →				FCP1808	ATE	
325i	160	01/05 → 12/11	FCP1773	ATE				
325i	160	01/05 → 12/11				FCP1807	ATE	
325i	160	06/07 → 12/11	FCP4191	ATE				
325i	160	06/07 → 12/11				FCP1807	ATE	
330i	200	03/07 → 08/08	FCP1773	ATE				
330i	200	03/07 → 08/08				FCP1808	ATE	
330i	200	09/07 → 12/11	FCP1773	ATE				
330xd	170	03/05 → 09/07	FCP1773	ATE				
330xd	170	03/05 → 09/07				FCP1808	ATE	
330xd	170	09/05 → 12/11	FCP1773	ATE				
330xi	200	09/07 → 12/11	FCP1773	ATE				

3 Touring (E30)

320 i	95	01/88 → 12/91	FCP660	LUCAS/TRW				
320 i	95	01/88 → 12/91				FCP296	ATE	

3 Touring (E46)

318i Touring	87, 105	04/99 →	FCP1300	ATE				
318i Touring	87, 105	04/99 →				FCP1301	ATE	
320i Touring	110	10/99 →	FCP1300	ATE				
320i Touring	110	10/99 →				FCP1301	ATE	
320Tdi Touring	110	10/99 →	FCP1300	ATE				
320Tdi Touring	110	10/99 →				FCP1301	ATE	
328i Touring	142	10/99 → 06/00	FCP1300	ATE				
328i Touring	142	10/99 → 06/00				FCP1301	ATE	
330 d	150	03/03 → 02/05	FCP1073	ATE				
330 d	150	03/03 → 02/05				FCP1483	ATE	

For material availability see page 16-18 / Per la disponibilità materiali vedere a pagina 16-18



KW



...BMW

...3 Touring (E46)

					NOTE			NOTE
330 d, 330 xd	135	10/99 →	FCP1073	ATE				
330 d, 330 xd	135	10/99 →				FCP1483	ATE	
330 i	170	06/00 → 02/05	FCP1073	ATE				
330 i	170	06/00 → 02/05				FCP1483	ATE	
330 xi	170	06/00 → 02/05	FCP1073	ATE				
330 xi	170	06/00 → 02/05				FCP1483	ATE	

3 Touring (E91)

318d	90	09/05 →	FCP1773	ATE				
318d	90	09/05 →				FCP1807	ATE	
318i	95	01/06 →	FCP1773	ATE				
318i	95	01/06 →				FCP1807	ATE	
320d	120	01/05 →	FCP1773	ATE				
320d	120	01/05 →				FCP1807	ATE	
320i	110	01/05 →	FCP1773	ATE				
320i	110	01/05 →				FCP1807	ATE	
320i	110	07/07 →	FCP4191	ATE				
320i	110	07/07 →				FCP1807	ATE	
325d	145	09/06 →	FCP1773	ATE				
325d	145	09/06 →	FCP1773	ATE				
325d	145	09/06 →				FCP1807	ATE	
325d	145	09/06 →				FCP1808	ATE	
330d	170	09/05 →	FCP1628	ATE				
330i	200	09/07 →	FCP1628	ATE				
330i	200	09/07 →	FCP1773	ATE				
330i	200	09/07 →				FCP1808	ATE	
330xd	170	06/05 → 09/07	FCP1773	ATE				
330xd	170	06/05 → 09/07				FCP1808	ATE	
330xd	170	09/05 →	FCP1628	ATE				
330xi	200	09/07 →	FCP1628	ATE				
335d	210	09/06 →	FCP1628	ATE				
335i	225	09/06 →	FCP1628	ATE				
335i	225	09/06 →				FCP1808	ATE	

3 Touring (F31)

316 d	85	06/12 →	FCP4611	Brembo	For vehicles with sports package			
316 d	85	06/12 →	FCP4489	ATE				
316 d	85	06/12 →				FCP4663	Brembo	For vehicles with sports package
316 i	100	03/13 →	FCP4611	Brembo	For vehicles with sports package			
316 i	100	03/13 →	FCP4489	ATE				
316 i	100	03/13 →				FCP4663	Brembo	For vehicles with sports package
318 d	100	06/12 →	FCP4489	ATE				
318 d	105	06/12 →	FCP4611	Brembo	For vehicles with sports package			
318 d	105	06/12 →	FCP4489	ATE				
318 d	105	06/12 →				FCP4663	Brembo	For vehicles with sports package
318 d	110	07/15 →	FCP4489	ATE				
318 d xDrive	105	01/13 →	FCP4611	Brembo	For vehicles with sports package			
318 d xDrive	105	01/13 →	FCP4489	ATE				
318 d xDrive	105	01/13 →				FCP4663	Brembo	For vehicles with sports package
318 d xDrive	110	07/15 →	FCP4489	ATE				
318 i	100	07/15 →	FCP4489	ATE				
320 d	120	06/12 →	FCP4611	Brembo	For vehicles with sports package			
320 d	120	06/12 →	FCP4394	BOSCH				
320 d	120	06/12 →	FCP4489	ATE				
320 d	120	06/12 →				FCP4663	Brembo	For vehicles with sports package
320 d	135	06/12 →	FCP4611	Brembo	For vehicles with sports package			
320 d	135	06/12 → 07/15	FCP4394	BOSCH				
320 d	135	06/12 →				FCP4663	Brembo	For vehicles with sports package
320 d xDrive	120	06/12 →	FCP4394	BOSCH				
320 d xDrive	135	06/12 →	FCP4611	Brembo	For vehicles with sports package			
320 d xDrive	135	06/12 → 07/15	FCP4394	BOSCH				
320 d xDrive	135	06/12 → 07/15	FCP4489	ATE				
320 d xDrive	135	06/12 →				FCP4663	Brembo	For vehicles with sports package
320 d xDrive	140	07/15 →	FCP4489	ATE				
320 i	135	06/12 →	FCP4611	Brembo	For vehicles with sports package			
320 i	135	06/12 →	FCP4394	BOSCH				
320 i	135	06/12 →	FCP4489	ATE				
320 i	135	06/12 →				FCP4663	Brembo	For vehicles with sports package
320 i	135	07/15 →	FCP4489	ATE				
320 i xDrive	135	06/12 →	FCP4611	Brembo	For vehicles with sports package			
320 i xDrive	135	06/12 →	FCP4394	BOSCH				
320 i xDrive	135	06/12 →	FCP4489	ATE				
320 i xDrive	135	06/12 →				FCP4663	Brembo	For vehicles with sports package
320 i xDrive	135	07/15 →	FCP4489	ATE				
325 d	155	03/13 →	FCP4394	BOSCH				
325 d	155	03/13 →	FCP4611	BREMBO	For Vehicles with Sport package			
325 d	160	03/13 →	FCP4611	Brembo	For vehicles with sports package			

For material availability see page 16-18 / Per la disponibilità materiali vedere a pagina 16-18



KW



...BMW

...3 Touring (F31)

					NOTE			NOTE
325 d	160	03/13 →	FCP4394	BOSCH				
325 d	160	03/13 →	FCP4489	ATE				
325 d	160	03/13 →				FCP4663	Brembo	For vehicles with sports package
328 i	180	06/12 →	FCP4611	Brembo	For vehicles with sports package			
328 i	180	06/12 →	FCP4394	BOSCH				
328 i	180	06/12 →	FCP4489	ATE				
328 i	180	06/12 →				FCP4663	Brembo	For vehicles with sports package
328 i xDrive	180	06/12 →	FCP4611	Brembo	For vehicles with sports package			
328 i xDrive	180	06/12 →	FCP4394	BOSCH				
328 i xDrive	180	06/12 →	FCP4489	ATE				
328 i xDrive	180	06/12 →				FCP4663	Brembo	For vehicles with sports package
330 d	190	06/12 →	FCP4611	Brembo	For vehicles with sports package			
330 d	190	06/12 →	FCP4394	BOSCH				
330 d	190	06/12 →	FCP4489	ATE				
330 d	190	06/12 →				FCP4663	Brembo	For vehicles with sports package
330 d	210	09/15 →	FCP4394	BOSCH				
330 d	210	09/15 →	FCP4611	BREMBO	For Vehicles with Sport package			
330 d xDrive	190	06/12 →	FCP4611	Brembo	For vehicles with sports package			
330 d xDrive	190	06/12 →	FCP4394	BOSCH				
330 d xDrive	190	06/12 →	FCP4489	ATE				
330 d xDrive	190	06/12 →				FCP4663	Brembo	For vehicles with sports package
330 d xDrive	210	09/15 →	FCP4394	BOSCH				
335 d xDrive	230	09/13 →	FCP4611	Brembo	For vehicles with sports package			
335 d xDrive	230	09/13 →	FCP4489	ATE				
335 d xDrive	230	09/13 →				FCP4663	BREMBO	For vehicles with sports package
335 i	225	03/13 →	FCP4611	Brembo	For vehicles with sports package			
335 i	225	03/13 →	FCP4489	ATE				
335 i	225	03/13 →				FCP4663	Brembo	For vehicles with sports package
335 i	240	01/12 → 07/13	FCP4611	BREMBO	For Vehicles with Sport package			
335 i	250	07/13 →	FCP4611	BREMBO	For Vehicles with Sport package			
335 i xDrive	225	03/13 →	FCP4611	Brembo	For vehicles with sports package			
335 i xDrive	225	03/13 →	FCP4489	ATE				
335 i xDrive	225	03/13 →				FCP4663	Brembo	For vehicles with sports package
335 i xDrive	240	01/12 → 07/13	FCP4611	BREMBO	For Vehicles with Sport package			
335 i xDrive	250	07/13 →	FCP4611	BREMBO	For Vehicles with Sport package			
340 i	265	07/15 →	FCP4611	BREMBO				
340 i xDrive	265	07/15 →	FCP4611	BREMBO				

4 Convertible (F33, F83)

420 d	120	10/13 →	FCP4394	BOSCH				
420 d	135	10/13 →	FCP4611	Brembo	For vehicles with sports package			
420 d	135	10/13 → 07/15	FCP4394	BOSCH				
420 d	135	10/13 → 07/15	FCP4489	ATE				
420 d	135	10/13 →				FCP4663	BREMBO	For vehicles with sports package
420 i	120	07/14 →	FCP4489	ATE				
420 i	135	07/14 →	FCP4489	ATE				
425 d	155	07/14 →	FCP4394	BOSCH				
425 d	155	07/14 →	FCP4611	BREMBO	For Vehicles with Sport package			
425 d	160	07/14 →	FCP4394	BOSCH				
425 d	160	07/14 →	FCP4611	BREMBO	For Vehicles with Sport package			
428 i	180	10/13 →	FCP4394	BOSCH				
428 i	180	10/13 →	FCP4611	BREMBO	For Vehicles with Sport package			
428 i xDrive	180	01/14 →	FCP4394	BOSCH				
428 i xDrive	180	01/14 →	FCP4611	BREMBO	For Vehicles with Sport package			
430 d	190	07/14 →	FCP4394	BOSCH				
430 d	190	07/14 →	FCP4611	BREMBO	For Vehicles with Sport package			
435 d xDrive	230	07/14 →	FCP4611	BREMBO	For Vehicles with Sport package			
435 i	225	10/13 →	FCP4611	Brembo	For vehicles with sports package			
435 i	225	10/13 →	FCP4489	ATE				
435 i	225	10/13 →				FCP4663	BREMBO	For vehicles with sports package
435 i	250	10/13 →	FCP4611	BREMBO				
435 i xDrive	225	07/14 →	FCP4611	BREMBO	For Vehicles with Sport package			
M4	317	07/14 →	FCP4611	Brembo				
M4	317	07/14 →				FCP4663	BREMBO	

4 Coupe

M4 GT4	317	01/18 →	FRP3150	AP RACING				
M4 GT4	317	01/18 →				FRP1078	AP RACING	

4 Coupe (F32, F82)

418 d	100	03/15 →	FCP4489	ATE				
418 d	110	03/15 →	FCP4489	ATE				
420 d	120	07/13 →	FCP4394	BOSCH				
420 d	135	07/13 →	FCP4611	Brembo	For vehicles with sports package			
420 d	135	07/13 → 03/15	FCP4394	BOSCH				
420 d	135	07/13 → 03/15	FCP4489	ATE				
420 d	135	07/13 →				FCP4663	Brembo	For vehicles with sports package

For material availability see page 16-18 / Per la disponibilità materiali vedere a pagina 16-18



KW



...BMW

...4 Coupe (F32, F82)

					NOTE			NOTE
420 d xDrive	120	11/13 →	FCP4394	BOSCH				
420 d xDrive	135	11/13 →	FCP4611	Brembo	For vehicles with sports package			
420 d xDrive	135	11/13 → 03/15	FCP4394	BOSCH				
420 d xDrive	135	11/13 → 03/15	FCP4489	ATE				
420 d xDrive	135	11/13 →				FCP4663	BREMBO	For vehicles with sports package
420 i	120	11/13 →	FCP4489	ATE				
420 i	135	11/13 →	FCP4611	Brembo	For vehicles with sports package			
420 i	135	11/13 →	FCP4489	ATE				
420 i	135	11/13 →				FCP4663	BREMBO	For vehicles with sports package
420 i xDrive	120	11/13 →	FCP4394	BOSCH				
420 i xDrive	120	11/13 →	FCP4489	ATE				
420 i xDrive	135	11/13 →	FCP4611	Brembo	For vehicles with sports package			
420 i xDrive	135	11/13 →	FCP4489	ATE				
420 i xDrive	135	11/13 →				FCP4663	BREMBO	For vehicles with sports package
425 d	155	01/14 →	FCP4394	BOSCH				
425 d	155	01/14 →	FCP4611	BREMBO	For Vehicles with Sport package			
425 d	160	01/14 →	FCP4394	BOSCH				
425 d	160	01/14 →	FCP4611	BREMBO	For Vehicles with Sport package			
428 i	180	07/13 →	FCP4611	Brembo	For vehicles with sports package			
428 i	180	07/13 →	FCP4394	BOSCH				
428 i	180	07/13 →				FCP4663	Brembo	For vehicles with sports package
428 i xDrive	180	07/13 →	FCP4611	Brembo	For vehicles with sports package			
428 i xDrive	180	07/13 →	FCP4394	BOSCH				
428 i xDrive	180	07/13 →				FCP4663	Brembo	For vehicles with sports package
430 d	190	11/13 →	FCP4394	BOSCH				
430 d	190	11/13 →	FCP4611	BREMBO	For Vehicles with Sport package			
430 d	210	11/13 →	FCP4611	BREMBO				
430 d xDrive	190	01/14 →	FCP4394	BOSCH				
430 d xDrive	190	01/14 →	FCP4611	BREMBO	For Vehicles with Sport package			
430 d xDrive	210	11/13 →	FCP4611	BREMBO				
435 d xDrive	230	11/13 →	FCP4611	Brembo	For vehicles with sports package			
435 d xDrive	230	11/13 →	FCP4489	ATE				
435 d xDrive	230	11/13 →				FCP4663	BREMBO	For vehicles with sports package
435 i	225	07/13 →	FCP4611	Brembo	For vehicles with sports package			
435 i	225	07/13 →	FCP4489	ATE				
435 i	225	07/13 →				FCP4663	Brembo	For vehicles with sports package
435 i	250	07/13 →	FCP4611	BREMBO	For Vehicles with Sport package			
435 i xDrive	225	07/13 →	FCP4611	Brembo	For vehicles with sports package			
435 i xDrive	225	07/13 →	FCP4489	ATE				
435 i xDrive	225	07/13 →				FCP4663	Brembo	For vehicles with sports package
435 i xDrive	250	07/13 →	FCP4611	BREMBO	For Vehicles with Sport package			
M4	317	01/14 →	FCP4611	Brembo				
M4	317	01/14 →				FCP4663	Brembo	

4 Gran Coupe (F36)

418 d	100	03/14 →	FCP4489	ATE				
418 d	105	03/14 →	FCP4489	ATE				
418 d	110	07/15 →	FCP4489	ATE				
418 i	100	07/15 →	FCP4489	ATE				
420 d	120	03/14 →	FCP4394	BOSCH				
420 d	135	03/14 → 03/15	FCP4489	ATE				
420 d xDrive	120	03/14 →	FCP4394	BOSCH				
420 d xDrive	135	03/14 → 03/15	FCP4394	BOSCH				
420 i	120	03/14 →	FCP4489	ATE				
420 i	135	03/14 →	FCP4489	ATE				
420 i xDrive	120	03/14 →	FCP4489	ATE				
420 i xDrive	135	07/14 →	FCP4489	ATE				
428 i	180	03/14 →	FCP4611	Brembo	For vehicles with sports package			
428 i	180	03/14 →	FCP4394	BOSCH				
428 i	180	03/14 →				FCP4663	Brembo	For vehicles with sports package
428 i xDrive	180	03/14 →	FCP4611	Brembo	For vehicles with sports package			
428 i xDrive	180	03/14 →	FCP4394	BOSCH				
428 i xDrive	180	03/14 →				FCP4663	Brembo	For vehicles with sports package
430 d	190	07/14 →	FCP4394	BOSCH				
430 d	190	07/14 →	FCP4611	BREMBO	For Vehicles with Sport package			
430 d xDrive	190	07/14 →	FCP4394	BOSCH				
430 d xDrive	190	07/14 →	FCP4611	BREMBO	For Vehicles with Sport package			
435 d xDrive	230	07/14 →	FCP4611	BREMBO	For Vehicles with Sport package			
435 i	225	03/14 →	FCP4611	Brembo	For vehicles with sports package			
435 i	225	03/14 →				FCP4663	Brembo	For vehicles with sports package
435 i	250	03/14 →	FCP4611	BREMBO				
435 i xDrive	225	07/14 →	FCP4611	Brembo	For vehicles with sports package			
435 i xDrive	225	07/14 →				FCP4663	Brembo	For vehicles with sports package

For material availability see page 16-18 / Per la disponibilità materiali vedere a pagina 16-18



KW



...BMW

5 (E12)

Model	Year	From	To	Part 1	Part 2	NOTE	Part 1	Part 2	NOTE
518i	66	07/76	→ 07/81	FCP399	ATE				
520	85, 92	09/72	→ 12/73	FCP399	ATE				
520	85, 92	07/76	→ 07/81	FCP399	ATE				
525	110	08/76	→ 05/81	FCP399	ATE				
525	110	08/76	→ 05/81				FCP3	ATE	
528i	125	08/76	→ 05/81	FCP399	ATE				
528i	125	08/76	→ 05/81				FCP3	ATE	
530		08/76	→ 05/81	FCP399	ATE				
530		08/76	→ 05/81				FCP3	ATE	
530		06/81	→ 05/88	FCP399	ATE				
530		06/81	→ 05/88				FCP2	ATE	

5 (E28)

3.5 24V M5	210	01/86	→ 05/88	FCP399	ATE				
3.5 24V M5	210	01/86	→ 05/88				FCP296	ATE	
3.5 24V M5	211	01/85	→ 12/87	FCP399	ATE				
3.5 24V M5	211	01/85	→ 12/87				FCP296	ATE	
518	66	07/81	→ 05/88	FCP256	ATE				
518	66	07/81	→ 05/88				FCP296	ATE	
520 i	110	12/86	→ 12/87	FCP256	ATE				
520 i	92	06/81	→ 12/87	FCP256	ATE				
520 i	95	08/85	→ 12/87	FCP256	ATE				
524	85	01/83	→ 05/88	FCP256	ATE				
524	85	01/83	→ 05/88				FCP296	ATE	
525 e 2.7	90	09/81	→ 12/87	FCP256	ATE				
525 e 2.7	90	09/81	→ 12/87				FCP296	ATE	
525 e 2.7	92	09/81	→ 12/87	FCP256	ATE				
525 e 2.7	92	09/81	→ 12/87				FCP296	ATE	
525 e 2.7	95	09/81	→ 12/87	FCP256	ATE				
525 e 2.7	95	09/81	→ 12/87				FCP296	ATE	
525i	110	06/81	→ 12/87	FCP256	ATE				
525i	110	06/81	→ 12/87				FCP296	ATE	
527	95	06/81	→ 05/88	FCP256	ATE				
527	95	06/81	→ 05/88				FCP296	ATE	
528i	135	06/81	→ 12/87	FCP256	ATE				
528i	135	06/81	→ 12/87				FCP296	ATE	
535 i, M 535 i	136	01/85	→ 12/87	FCP256	ATE				
535 i, M 535 i	136	01/85	→ 12/87				FCP296	ATE	
535 i, M 535 i	141	01/85	→ 12/87	FCP256	ATE				
535 i, M 535 i	141	01/85	→ 12/87				FCP296	ATE	
535 i, M 535 i	160	01/85	→ 12/87	FCP256	ATE				
535 i, M 535 i	160	01/85	→ 12/87				FCP296	ATE	

5 (E34)

3.5 24V M5	232	06/88	→ 12/91	FCP779	ATE				
3.5 24V M5	232	06/88	→ 12/91				FCP578	ATE	
3.8 i 24V M5	250	03/92	→ 06/94	FCP779	ATE				
3.8 i 24V M5	250	03/92	→ 06/94				FCP578	ATE	
3.8 i 24V M5	250	06/94	→ 09/95	FCP1298	BREMBO				
3.8 i 24V M5	250	06/94	→ 09/95				FCP1483	ATE	
518i	83	08/89	→ 09/95	FCP779	ATE				
518i	83	08/89	→ 09/95				FCP578	ATE	
518i	85	08/89	→ 09/95	FCP779	ATE				
518i	85	08/89	→ 09/95				FCP578	ATE	
520i / 520i 24V	95, 110	06/88	→ 09/95	FCP779	ATE				
520i / 520i 24V	95, 110	06/88	→ 09/95				FCP578	ATE	
524td	85	03/88	→ 09/95	FCP779	ATE				
524td	85	03/88	→ 09/95				FCP578	ATE	
525	85, 105	06/88	→ 12/89	FCP779	ATE				
525	85, 105	06/88	→ 12/89				FCP578	ATE	
525	85, 105	01/90	→ 09/95	FCP779	ATE				
525	85, 105	01/90	→ 09/95				FCP578	ATE	
525 i	125	01/88	→ 08/91	FCP779	ATE				
525 i	125	01/88	→ 08/91				FCP578	ATE	
525 i 24V	141	09/89	→ 09/95	FCP779	ATE				
525 i 24V	141	09/89	→ 09/95				FCP578	ATE	
525 iX 24V	141	10/91	→ 09/95	FCP779	ATE				
525 iX 24V	141	10/91	→ 09/95				FCP578	ATE	
525 Touring	85, 105	07/91	→ 01/97	FCP779	ATE				
525 Touring	85, 105	07/91	→ 01/97				FCP578	ATE	
525d	85, 105	06/88	→ 12/89	FCP779	ATE				
525d	85, 105	06/88	→ 12/89				FCP578	ATE	
525d	85, 105	01/90	→ 09/95	FCP779	ATE				
525d	85, 105	01/90	→ 09/95				FCP578	ATE	
525iX 4wd 24V		01/90	→ 06/96	FCP779	ATE				
525iX 4wd 24V		01/90	→ 06/96				FCP578	ATE	
525td	85	06/88	→ 12/89	FCP779	ATE				

For material availability see page 16-18 / Per la disponibilità materiali vedere a pagina 16-18



KW



...BMW

...5 (E34)

Model	Year	Period	FCP	ATE	NOTE	FCP	ATE	NOTE
525td	85	06/88 → 12/89				FCP578	ATE	
525td	85	01/90 → 09/95	FCP779	ATE				
525td	85	01/90 → 09/95				FCP578	ATE	
530i / 530i V8 32V	138, 160	06/88 → 09/95	FCP779	ATE				
530i / 530i V8 32V	138, 160	06/88 → 09/95				FCP578	ATE	
535i	155	06/88 → 09/95	FCP779	ATE				
535i	155	06/88 → 09/95				FCP578	ATE	
540i V8 32V	210	01/92 → 09/95	FCP779	ATE				
540i V8 32V	210	01/92 → 09/95				FCP578	ATE	

5 (E39)

Model	Year	Period	FCP	ATE	NOTE	FCP	ATE	NOTE
4.9 32V M5	294	10/98 → 06/03	FCP997	ATE				
4.9 32V M5	294	10/98 → 06/03				FCP1483	ATE	
520 i	100	04/99 → 06/03	FCP1073	ATE				
520 i	100	04/99 → 06/03				FCP850	ATE	
520 i	110	01/96 → 09/00	FCP1073	ATE				
520 i	110	01/96 → 09/00				FCP850	ATE	
520i	125	09/00 → 06/03	FCP1773	ATE	Automatic			
520i	125	09/00 → 06/03	FCP1073	ATE				
520i	125	09/00 → 06/03				FCP850	ATE	
523i / 525i	125, 141	09/95 → 06/03	FCP1073	ATE				
523i / 525i	125, 141	09/95 → 06/03				FCP850	ATE	
525d	105	09/95 →	FCP1073	ATE				
525d	105	09/95 →				FCP850	ATE	
525d Touring	105	09/95 →	FCP1073	ATE				
525d Touring	105	09/95 →				FCP850	ATE	
525td	105	09/95 → 06/03	FCP1073	ATE				
525td	105	09/95 → 06/03				FCP850	ATE	
525td Touring	105	02/97 →	FCP1073	ATE				
525td Touring	105	02/97 →				FCP850	ATE	
528i	142	09/95 → 09/00	FCP1073	ATE				
528i	142	09/95 → 09/00				FCP850	ATE	
530d	135	08/98 → 09/00	FCP1073	ATE				
530d	135	08/98 → 09/00				FCP850	ATE	
530d	142	09/00 → 06/03	FCP997	ATE				
530d	142	09/00 → 06/03				FCP1301	ATE	
530d	142	09/00 → 06/03				FCP850	ATE	
530i	170	09/00 → 06/03	FCP997	ATE				
530i	170	09/00 → 06/03				FCP1301	ATE	
535i	173	04/96 → 03/99	FCP1073	ATE				
535i	173	04/96 → 03/99				FCP850	ATE	
535i	180	04/99 → 06/03	FCP997	ATE				
535i	180	04/99 → 06/03				FCP1301	ATE	
540i	210	04/96 → 06/03	FCP997	ATE				
540i	210	04/96 → 06/03				FCP1301	ATE	

5 (E60)

5.0 40V M5	373	09/04 → 03/10				FCP1672	ATE	
------------	-----	---------------	--	--	--	---------	-----	--

5 (E61)

5.0 40V Touring M5	373	02/07 →				FCP1672	ATE	
--------------------	-----	---------	--	--	--	---------	-----	--

5 (F10)

530 d	180	01/09 → 08/11	FCP4191	ATE	For vehicles without Sport package			
530 d	180	01/09 → 08/11				FCP4381	LUCAS/TRW	
530 d	190	01/11 → 10/16	FCP4191	ATE	For vehicles without Sport package			
530 d	190	01/11 → 10/16				FCP4381	LUCAS/TRW	
530 d xDrive	190	09/10 → 10/16	FCP4191	ATE	For vehicles without Sport package			
530 d xDrive	190	09/10 → 10/16				FCP4381	LUCAS/TRW	
530 d xDrive	210	09/10 → 10/16	FCP4191	ATE	For vehicles without Sport package			
530 d xDrive	210	09/10 → 10/16				FCP4381	LUCAS/TRW	
530 i	200	05/11 → 06/13	FCP4191	ATE	For vehicles without Sport package			
530 i	200	05/11 → 06/13				FCP4381	LUCAS/TRW	
535 i	240	07/13 → 10/16	FCP4191	ATE	For vehicles without Sport package			
535 i	240	07/13 → 10/16				FCP4381	LUCAS/TRW	
535 i xDrive	240	07/13 → 10/16	FCP4191	ATE	For vehicles without Sport package			
535 i xDrive	240	07/13 → 10/16				FCP4381	LUCAS/TRW	
ActiveHybrid	225	09/10 → 08/16	FCP4191	ATE	For vehicles without Sport package			
ActiveHybrid	225	09/10 → 08/16				FCP4381	LUCAS/TRW	
ActiveHybrid	250	09/10 → 08/16	FCP4191	ATE	For vehicles without Sport package			
ActiveHybrid	250	09/10 → 08/16				FCP4381	LUCAS/TRW	

For material availability see page 16-18 / Per la disponibilità materiali vedere a pagina 16-18

1058

FERODO

RACING

Updated on 17th Aug 2018



KW



...BMW

5 (F10, F18)

					NOTE			NOTE
530 d	210	10/15	→			FCP4381	LUCAS/TRW	
535 d	220	08/10	→			FCP4381	LUCAS/TRW	
535 d	230	09/11	→			FCP4381	LUCAS/TRW	
535 d xDrive	230	09/11	→			FCP4381	LUCAS/TRW	
535 i	225	12/09	→			FCP4381	LUCAS/TRW	
535 i xDrive	225	03/11	→			FCP4381	LUCAS/TRW	
550 i	300	02/10	→			FCP4381	LUCAS/TRW	
550 i	330	05/13	→			FCP4381	LUCAS/TRW	
550 i xDrive	300	08/10	→			FCP4381	LUCAS/TRW	
550 i xDrive	330	05/13	→			FCP4381	LUCAS/TRW	
M 550 d xDrive	280	01/12	→			FCP4381	LUCAS/TRW	
M5	412	06/11	→	FCP4712	Brembo	for vehicles without ceramic discs		
M5	412	06/11	→			FCP4381	LUCAS/TRW	for vehicles without ceramic discs
M5	423	01/14	→	FCP4712	Brembo	for vehicles without ceramic discs		
M5	423	01/14	→			FCP4381	LUCAS/TRW	
M5	441	07/14	→	FCP4712	Brembo	for vehicles without ceramic discs		
M5	441	07/14	→			FCP4381	LUCAS/TRW	for vehicles without ceramic discs

5 Saloon (E60)

520d	110	09/05	→ 03/10	FCP1773	ATE	Automatic		
520d	120	07/05	→	FCP1773	ATE	Automatic		
520d	120	07/05	→ 03/10	FCP1773	ATE	Automatic		
520i	120	12/06	→ 03/10	FCP1773	ATE	Automatic		
520i	125	07/03	→ 03/10	FCP1628	ATE	Automatic		
520i	125	09/07	→ 03/10	FCP1773	ATE	Automatic		
523i	130	07/05	→	FCP1628	ATE	Automatic		
523i	140	01/07	→	FCP1773	ATE	Automatic		
525d	120	12/04	→ 03/10	FCP1628	ATE	Automatic		
525d	120	12/04	→ 03/10	FCP1773	ATE	Automatic		
525d	130	06/04	→ 03/10	FCP1628	ATE	Automatic		
525d	130	06/04	→ 03/10	FCP1773	ATE	Automatic		
525i	141	09/03	→	FCP1628	ATE	Automatic		
525i	141	09/03	→	FCP1773	ATE	Automatic		
525i	160	07/05	→	FCP1628	ATE	Automatic		
525i	160	07/05	→	FCP1773	ATE	Automatic		
525xi	160	07/05	→	FCP1628	ATE			
530d	160	07/03	→ 03/10	FCP1628	ATE	-> 06/05		
530d	170	07/03	→ 03/10	FCP1628	ATE	-> 06/05		
530i	170	07/03	→	FCP1628	ATE	-> 06/05		
530i	190	07/05	→	FCP1628	ATE			
530xd	170	07/05	→	FCP1628	ATE			
530xi	190	07/05	→	FCP1628	ATE			
535d	200	09/04	→ 03/10				FCP1672	ATE
535d	210	01/07	→ 03/10				FCP1672	ATE
540i	225	07/05	→	FCP1628	ATE			
All 545i	245	09/03	→	FCP1628	ATE	-> 06/05		

5 Touring (E34)

525 i	141	11/91	→ 01/97	FCP779	ATE			
525 i	141	11/91	→ 01/97				FCP578	ATE
525 ix	141	02/92	→ 01/97	FCP779	ATE			
525 ix	141	02/92	→ 01/97				FCP578	ATE

5 Touring (E39)

520 i	100	04/99	→ 05/04	FCP1073	ATE			
520 i	100	04/99	→ 05/04				FCP850	ATE
520 i	110	01/97	→ 09/00	FCP1073	ATE			
520 i	110	01/97	→ 09/00				FCP850	ATE
520 i	125	09/00	→ 05/04	FCP1628	ATE	Automatic		
520 i	125	09/00	→ 05/04	FCP1073	ATE			
520 i	125	09/00	→ 05/04				FCP850	ATE
523i / 525i	125, 141	09/95	→ 05/04	FCP1073	ATE			
523i / 525i	125, 141	09/95	→ 05/04				FCP850	ATE
528i	142	09/95	→ 09/00	FCP1073	ATE			
528i	142	09/95	→ 09/00				FCP850	ATE
530d	135	08/98	→ 09/00	FCP1073	ATE			
530d	135	08/98	→ 09/00				FCP1301	ATE
530d	142	09/00	→ 05/04	FCP997	ATE			
530d	142	09/00	→ 05/04				FCP1301	ATE
530i	170	09/00	→ 05/04	FCP997	ATE			
530i	170	09/00	→ 05/04				FCP1301	ATE
535i	173	04/96	→ 03/99	FCP1073	ATE			
535i	173	04/96	→ 03/99				FCP850	ATE
540i	210	01/97	→ 05/04	FCP997	ATE			
540i	210	01/97	→ 05/04				FCP1301	ATE

For material availability see page 16-18 / Per la disponibilità materiali vedere a pagina 16-18

BMW



KW



...BMW

5 Touring (E61)

					NOTE			NOTE
520d	110	09/05 →	FCP1773	ATE	government vehicles			
520d	120	07/05 →	FCP1773	ATE	government vehicles			
520d	120	07/05 →	FCP1628	ATE				
520d	120	07/05 →	FCP1773	ATE	government vehicles			
520i	125	09/07 →	FCP1773	ATE	Automatic			
520i	163	07/05 →	FCP1628	ATE				
520i	163	07/05 →	FCP1773	ATE	government vehicles			
523i	130	07/05 →	FCP1628	ATE	Automatic			
523i	140	01/07 →	FCP1773	ATE	Automatic			
525d	120	06/04 →	FCP1773	ATE	government vehicles			
525d	120	12/04 →	FCP1628	ATE				
525d	130	06/04 →	FCP1628	ATE				
525d	130	06/04 →	FCP1773	ATE	government vehicles			
525i	141	06/04 →	FCP1628	ATE	Automatic			
525i	141	06/04 →	FCP1773	ATE	Automatic			
525i	160	07/05 →	FCP1628	ATE	Automatic			
525i	160	07/05 →	FCP1773	ATE	Automatic			
525xi	160	07/05 →	FCP1628	ATE	-> 06/05			
530d	160	06/04 →	FCP1628	ATE	-> 06/05			
530xd	170	07/05 →	FCP1628	ATE	-> 06/05			
530xi	190	07/05 →	FCP1628	ATE	-> 06/05			
545i	245	06/04 →	FCP1628	ATE	-> 06/05			
All 530i	231	06/04 →	FCP1628	ATE	-> 06/05			
All 530i	258	07/05 →	FCP1628	ATE	-> 06/05			

5 Touring (F11)

518 d	100	01/13 →				FCP4381	LUCAS/TRW	
518 d	105	01/13 →				FCP4381	LUCAS/TRW	
518 d	110	05/14 →				FCP4381	LUCAS/TRW	
520 d	120	04/10 →				FCP4381	LUCAS/TRW	
520 d	135	09/10 →				FCP4381	LUCAS/TRW	
520 d	140	05/14 →				FCP4381	LUCAS/TRW	
520 d xDrive	120	02/13 →				FCP4381	LUCAS/TRW	
520 d xDrive	135	02/13 →				FCP4381	LUCAS/TRW	
520 d xDrive	140	05/14 →				FCP4381	LUCAS/TRW	
525 d xDrive	155	09/11 →				FCP4381	LUCAS/TRW	
525 d xDrive	160	09/11 →				FCP4381	LUCAS/TRW	
530 d	190	09/11 →				FCP4381	LUCAS/TRW	
530 d	210	10/15 →				FCP4381	LUCAS/TRW	
530 d xDrive	190	09/11 →				FCP4381	LUCAS/TRW	
530 d xDrive	210	10/15 →				FCP4381	LUCAS/TRW	
535 d	220	09/10 →				FCP4381	LUCAS/TRW	
535 d	230	09/11 →				FCP4381	LUCAS/TRW	
535 d xDrive	230	09/11 →				FCP4381	LUCAS/TRW	
535 i	225	09/10 →				FCP4381	LUCAS/TRW	
535 i	240	10/15 →				FCP4381	LUCAS/TRW	
535 i xDrive	225	09/11 →				FCP4381	LUCAS/TRW	
535 i xDrive	240	10/15 →				FCP4381	LUCAS/TRW	
550 i	300	09/10 →				FCP4381	LUCAS/TRW	
550 i	330	05/13 →				FCP4381	LUCAS/TRW	
M 550 d xDrive	280	01/12 →				FCP4381	LUCAS/TRW	

6 (E24)

525		01/76 → 06/82	FCP399	ATE				
525		01/76 → 06/82				FCP3	ATE	
530	135	01/76 → 12/80	FCP399	ATE				
530	135	01/76 → 12/80				FCP3	ATE	
530	135	01/81 → 08/82	FCP399	ATE				
530	135	01/81 → 08/82				FCP3	ATE	
628Csi	135	09/79 → 08/87	FCP399	ATE	-> 06/82			
628Csi	135	09/79 → 08/87	FCP256	ATE	07/82 ->			
628Csi	135	09/79 → 08/87				FCP3	ATE	-> 06/82
628Csi	135	09/79 → 08/87				FCP296	ATE	07/82 ->
630	135	01/81 → 08/82	FCP256	ATE				
630	135	01/81 → 08/82				FCP296	ATE	
633Csi	145	04/76 → 08/84	FCP399	ATE				
633Csi	145	04/76 → 08/84				FCP3	ATE	
635Csi	160	06/78 → 06/82	FCP399	ATE	-> 06/82			
635Csi	160	06/78 → 06/82				FCP3	ATE	->06/82
635i	160	07/82 → 12/89	FCP256	ATE	06/82 ->			
635i	160	07/82 → 12/89				FCP296	ATE	06/82 ->
M 635Csi	211	03/84 → 05/89	FCP256	ATE				
M 635Csi	211	03/84 → 05/89				FCP296	ATE	

For material availability see page 16-18 / Per la disponibilità materiali vedere a pagina 16-18

1060

FERODO

RACING

Updated on 17th Aug 2018



KW



...BMW

6 (E63)

					NOTE			NOTE
630i	190	09/04 →	FCP1628	ATE				
630i	190	09/04 →				FCP1672	ATE	
645Ci	245	01/04 →	FCP1628	ATE				
645Ci	245	01/04 →				FCP1672	ATE	
650i	270	07/05 →				FCP1672	ATE	

6 Convertible (E64)

630i	190	09/04 →	FCP1628	ATE				
630i	190	09/04 →				FCP1672	ATE	
645Ci	245	04/04 →	FCP1628	ATE				
645Ci	245	04/04 →				FCP1672	ATE	
650i	270	07/05 →				FCP1672	ATE	

6 Convertible (F12)

640 d	230	09/11 →				FCP4381	LUCAS/TRW	
640 d xDrive	230	09/11 →				FCP4381	LUCAS/TRW	
640 i	235	03/11 →				FCP4381	LUCAS/TRW	
640 i xDrive	235	01/13 →				FCP4381	LUCAS/TRW	
650 i	300	03/11 →				FCP4381	LUCAS/TRW	
650 i	330	10/11 →				FCP4381	LUCAS/TRW	
650 i xDrive	300	06/11 →				FCP4381	LUCAS/TRW	
650 i xDrive	330	11/11 →				FCP4381	LUCAS/TRW	
M6	412	01/12 →	FCP4712	Brembo				
M6	412	01/12 →				FCP4381	LUCAS/TRW	
M6	423	02/14 →	FCP4712	Brembo	for vehicles without ceramic discs			
M6	423	02/14 →				FCP4381	LUCAS/TRW	
M6	441	07/15 →	FCP4712	Brembo	NOT FOR CERAMIC DISCS,Not for SA code:S4007			
M6	441	07/15 →				FCP4381	LUCAS/TRW	

6 Coupe

M6 GT3	430	01/16 →	FRP3150	AP RACING				
--------	-----	---------	---------	-----------	--	--	--	--

6 Coupe (F13)

640 d	230	11/10 →				FCP4381	LUCAS/TRW	
640 d xDrive	230	09/11 →				FCP4381	LUCAS/TRW	
640 i	235	11/10 →				FCP4381	LUCAS/TRW	
640 i xDrive	235	01/13 →				FCP4381	LUCAS/TRW	
650 i	300	11/10 →				FCP4381	LUCAS/TRW	
650 i	330	10/11 →				FCP4381	LUCAS/TRW	
650 i xDrive	300	06/11 →				FCP4381	LUCAS/TRW	
650 i xDrive	330	11/11 →				FCP4381	LUCAS/TRW	
M6	412	01/12 →	FCP4712	Brembo				
M6	412	01/12 →				FCP4381	LUCAS/TRW	
M6	423	02/14 →	FCP4712	Brembo	for vehicles without ceramic discs			
M6	423	02/14 →				FCP4381	LUCAS/TRW	
M6	441	07/15 →	FCP4712	Brembo	NOT FOR CERAMIC DISCS,Not for SA code:S4007			
M6	441	07/15 →				FCP4381	LUCAS/TRW	

6 Gran Coupe (F06)

640 d	230	09/11 →				FCP4381	LUCAS/TRW	
640 d xDrive	230	01/13 →				FCP4381	LUCAS/TRW	
640 i	235	09/11 →				FCP4381	LUCAS/TRW	
640 i xDrive	235	01/13 →				FCP4381	LUCAS/TRW	
650 i	330	11/11 →				FCP4381	LUCAS/TRW	
650 i xDrive	330	11/11 →				FCP4381	LUCAS/TRW	
M6	410	11/13 →	FCP4712	Brembo	for vehicles without ceramic discs			
M6	412	12/12 →	FCP4712	Brembo	for vehicles without ceramic discs			
M6	412	12/12 →				FCP4381	LUCAS/TRW	for vehicles without ceramic discs
M6	423	02/14 →	FCP4712	Brembo	for vehicles without ceramic discs			
M6	423	02/14 →				FCP4381	LUCAS/TRW	
M6	441	07/15 →				FCP4381	LUCAS/TRW	

7 (E23)

725		01/77 → 12/79	FCP399	ATE				
725		01/77 → 12/79				FCP2	ATE	
725	110	08/81 → 08/86	FCP399	ATE				
725	110	08/81 → 08/86				FCP296	ATE	
728	125	01/77 → 07/81	FCP399	ATE				
728	125	01/77 → 08/79	FCP399	ATE				
728	125	01/77 → 07/81				FCP2	ATE	
728	125	01/77 → 08/79				FCP2	ATE	
728i	135	07/78 → 08/86	FCP399	ATE				
728i	135	07/78 → 08/86				FCP296	ATE	08/81 ->
730	135	01/77 → 12/79	FCP399	ATE				
730	135	01/77 → 12/79				FCP2	ATE	
730	135	05/77 → 08/79	FCP399	ATE				

For material availability see page 16-18 / Per la disponibilità materiali vedere a pagina 16-18



KW

**...BMW****...7 (E23)**

				NOTE			NOTE
730	135	05/77 → 08/79			FCP2	ATE	
730	135	01/80 → 08/81	FCP399	ATE			
730	135	01/80 → 08/81			FCP2	ATE	
732i / 733i	145	05/77 → 08/86	FCP399	ATE			
732i / 733i	145	05/77 → 08/86			FCP2	ATE	->08/81
732i / 733i	145	05/77 → 08/86			FCP296	ATE	08/81->
735 i	136	01/85 → 08/86	FCP399	ATE			
735 i	136	01/85 → 08/86			FCP296	ATE	
735 i	141	04/85 → 08/86	FCP399	ATE			
735 i	141	04/85 → 08/86			FCP296	ATE	
745 i	185	04/80 → 04/83	FCP399	ATE			
745 i	185	04/80 → 04/83			FCP296	ATE	
745 i	185	05/83 → 08/86	FCP399	ATE			
745 i	185	05/83 → 08/86			FCP296	ATE	
745 i	220	08/81 → 04/83	FCP399	ATE			
745 i	220	08/81 → 04/83			FCP2	ATE	-> 08/81

7 (E32)

730i / iL	138, 145	01/85 → 09/94	FCP779	ATE			
730i / iL	138, 145	01/85 → 09/94			FCP578	ATE	
730i / iL V8	160	01/92 → 06/94	FCP779	ATE			
730i / iL V8	160	01/92 → 06/94			FCP578	ATE	
735i, iL	155, 160	09/86 → 09/92	FCP779	ATE			
735i, iL	155, 160	09/86 → 09/92			FCP578	ATE	
740i / iL V12	220	09/87 → 09/94	FCP779	ATE			
740i / iL V12	220	09/87 → 09/94			FCP578	ATE	
740i / iL V8	210	04/92 → 09/94	FCP779	ATE			
740i / iL V8	210	04/92 → 09/94			FCP578	ATE	

7 (E38)

725 tds	143	04/96 → 11/01	FCP1298	BREMBO			
725 tds	105	04/96 → 11/01	FCP1298	BREMBO			
725 tds	105	04/96 → 11/01			FCP1483	ATE	
728 i,iL	193	08/95 → 11/01	FCP1298	BREMBO			
728 i,iL	142	08/95 → 11/01	FCP1298	BREMBO			
728 i,iL	142	08/95 → 11/01			FCP1483	ATE	
728i X	142	11/95 → 09/01	FCP1298	BREMBO			
728i X	142	11/95 → 09/01			FCP1483	ATE	
730 d	184, 193	08/98 → 11/01	FCP1298	BREMBO			
730 d	135	08/98 → 04/00	FCP1298	BREMBO			
730 d	135	08/98 → 04/00			FCP1483	ATE	
730 d	142	04/00 → 11/01	FCP1298	BREMBO			
730 d	142	04/00 → 11/01			FCP1483	ATE	
730 i, iL	155	10/94 → 11/01	FCP1298	BREMBO			
730 i, iL	155	10/94 → 11/01			FCP1483	ATE	
730 i, iL	160	10/94 → 11/01	FCP1298	BREMBO			
730 i, iL	160	10/94 → 11/01			FCP1483	ATE	
730 i,iL	211, 218	10/94 → 11/01	FCP1298	BREMBO			
735 i,iL	235	01/96 → 11/01	FCP1298	BREMBO			
735 i,iL	173	01/96 → 11/01	FCP1298	BREMBO			
735 i,iL	173	01/96 → 11/01			FCP1483	ATE	
740 d	180	05/99 → 11/01			FCP1483	ATE	
740 i, iL	210	10/94 → 11/01	FCP997	ATE			
740 i, iL	210	10/94 → 11/01			FCP1483	ATE	
750 i, iL	240	12/94 → 11/01			FCP1483	ATE	

7 (E65, E66, E67)

730 d	160	10/02 →	FCP1628	ATE			
730 d	160	10/02 →			FCP1672	ATE	
730 i,Li	170	03/03 →	FCP1628	ATE			
730 i,Li	170	03/03 →			FCP1672	ATE	
730 i,Li	190	03/05 →	FCP1628	ATE			
730 i,Li	190	03/05 →			FCP1672	ATE	
730 Ld	170	07/05 →	FCP1628	ATE			
730 Ld	170	07/05 →			FCP1672	ATE	
735 i,Li	200	11/01 →	FCP1628	ATE			
735 i,Li	200	11/01 →	FCP1298	BREMBO			
735 i,Li	200	11/01 →			FCP1672	ATE	
740 d	190	10/02 →	FCP1628	ATE			
740 d	190	10/02 →			FCP1672	ATE	
745 d	242	07/05 →	FCP1628	ATE			
745 d	242	07/05 →			FCP1672	ATE	
745 i,Li	245	11/01 →	FCP1628	ATE			
745 i,Li	245	11/01 →			FCP1672	ATE	
All 740 i,Li	225	07/05 →	FCP1628	ATE			
All 740 i,Li	225	07/05 →			FCP1672	ATE	

For material availability see page 16-18 / Per la disponibilità materiali vedere a pagina 16-18

1062

FERODO

RACING

Updated on 17th Aug 2018



KW



...BMW

8 (E31)

830 Ci	160	08/92 → 12/99
840 Ci	286	01/96 → 12/99
840 Ci	286	01/96 → 12/99
840 i	286	02/93 → 02/96
840Ci	210	01/96 → 12/99
840Ci	210	01/96 → 12/99
840i	210	02/93 → 02/96
840i	210	02/93 → 02/96
840i	210	02/93 → 02/96
850 Ci	326	09/94 → 12/99
850 Ci	326	09/94 → 12/99
850 i,Ci	300	04/90 → 10/94
850Ci	240	09/94 → 12/99
850Ci	240	09/94 → 12/99
850Csi	280	04/93 → 12/96
850Csi	280	04/93 → 12/96
850i / 850Ci	220	04/93 → 02/96
850i / 850Ci	220	04/93 → 02/96
850i /850Ci	220	04/90 → 10/94
850i /850Ci	220	04/90 → 10/94

i8

i8	170	03/14 →
----	-----	---------

X1 (E84)

sDrive 16d 2.0	85	07/12 →
sDrive 16d 2.0	85	07/12 →
sDrive 18d 2.0	100	12/09 →
sDrive 18d 2.0	100	12/09 →
sDrive 18d 2.0	105	12/09 →
sDrive 18d 2.0	105	12/09 →
sDrive 18i 2.0	100	01/10 → 10/12
sDrive 18i 2.0	100	01/10 → 10/12
sDrive 18i 2.0	110	01/10 →
sDrive 18i 2.0	110	01/10 →
sDrive 20d 2.0	130	10/09 →
sDrive 20d 2.0	130	10/09 →
sDrive 20d 2.0	135	08/12 →
sDrive 20d 2.0	135	08/12 →
sDrive 20d 2.0 - Efficient Dynamics	120	03/10 →
sDrive 20d 2.0 - Efficient Dynamics	120	03/10 →
sDrive 20i 2.0	135	09/11 →
sDrive 20i 2.0	135	09/11 →
xDrive 18d 2.0	100	12/09 →
xDrive 18d 2.0	100	12/09 →
xDrive 18d 2.0	105	12/09 →
xDrive 18d 2.0	105	12/09 →
xDrive 20d 2.0	120	03/10 →
xDrive 20d 2.0	120	03/10 →
xDrive 20d 2.0	130	10/09 →
xDrive 20d 2.0	130	10/09 →
xDrive 20d 2.0	135	08/12 →
xDrive 20d 2.0	135	08/12 →
xDrive 20i 2.0	135	09/11 →
xDrive 20i 2.0	135	09/11 →
xDrive 25d 2.0 - Twin Turbo	160	07/12 →
xDrive 25d 2.0 - Twin Turbo	160	07/12 →

X3 (E83)

2.0 d	110	10/04 →
2.0 d	110	10/04 →
2.0 i	110	07/05 →
2.0 i	110	07/05 →
2.5 i	141	01/04 →
2.5 i	141	01/04 →
3.0 d	150	01/04 →
3.0 d	150	01/04 →
3.0 d	160	01/04 →
3.0 d	160	01/04 →
3.0 i	170	01/04 →
3.0 i	170	01/04 →
3.0 sd	210	09/06 →
3.0 sd	210	09/06 →

			NOTE			NOTE
FCP1298	BREMBO					
FCP1298	BREMBO					
FCP857	ATE					
FCP1298	ATE		->03/94			
FCP1298	BREMBO					
FCP857	ATE					
FCP856	ATE		-> 03/94			
FCP1298	BREMBO		03/94 ->			
FCP857	ATE					
FCP857	ATE					
FCP1298	BREMBO		03/94->			
FCP857	ATE					
FCP1298	ATE		->03/94			
FCP1298	BREMBO		03/94 ->			
FCP857	ATE					
FCP857	ATE					
FCP856	ATE		-> 03/94			
FCP857	ATE					
FCP1298	BREMBO		03/94 ->			
FCP857	ATE					
FCP856	ATE		-> 03/94			
FCP857	ATE					
FCP4611	Brembo		For vehicles with sports package			
FCP4191	ATE					
FCP1807	ATE					
FCP4191	ATE					
FCP1807	ATE					
FCP4191	ATE					
FCP1807	ATE					
FCP4191	ATE					
FCP1807	ATE					
FCP4191	ATE					
FCP1807	ATE					
FCP4191	ATE					
FCP1807	ATE					
FCP4191	ATE					
FCP1807	ATE					
FCP4191	ATE					
FCP1807	ATE					
FCP4191	ATE					
FCP1807	ATE					
FCP4191	ATE					
FCP1807	ATE					
FCP1073	ATE					
FCP1483	ATE					
FCP1073	ATE					
FCP1483	ATE					
FCP1073	ATE					
FCP1483	ATE					
FCP1073	ATE					
FCP1483	ATE					
FCP1073	ATE					
FCP1483	ATE					
FCP1073	ATE					
FCP1483	ATE					
FCP1073	ATE					
FCP1483	ATE					

BMW

For material availability see page 16-18 / Per la disponibilità materiali vedere a pagina 16-18



KW



...BMW

						NOTE			NOTE
X3 (F25)									
sDrive 18 d	100	08/11	→	FCP4394	BOSCH				
sDrive 18 d	105	08/11	→	FCP4394	BOSCH				
sDrive 18 d	110	02/14	→	FCP4394	BOSCH				
sDrive 18 i	125	04/14	→	FCP4394	BOSCH				
sDrive 20 i	135	02/14	→	FCP4394	BOSCH				
xDrive 20 d	120	09/10	→	FCP4394	BOSCH				
xDrive 20 d	135	09/10	→	FCP4394	BOSCH				
xDrive 20 d	140	02/14	→	FCP4394	BOSCH				
xDrive 20 i	135	09/11	→	FCP4394	BOSCH				
xDrive 28 d	134	09/14	→	FCP4394	BOSCH				
xDrive 28 i	180	08/11	→	FCP4394	BOSCH				
xDrive 28 i	190	04/11	→	FCP4394	BOSCH				
xDrive 30 d	155	05/11	→	FCP4394	BOSCH				
xDrive 30 d	190	05/11	→	FCP4394	BOSCH				
xDrive 35 d	230	09/11	→	FCP4394	BOSCH				
xDrive 35 i	225	09/10	→	FCP4394	BOSCH				
X4 (F26)									
xDrive 20 d	120	06/14	→	FCP4394	BOSCH				
xDrive 20 d	140	04/14	→	FCP4394	BOSCH				
xDrive 20 i	135	04/14	→	FCP4394	BOSCH				
xDrive 28 i	180	04/14	→	FCP4394	BOSCH				
xDrive 30 d	155	04/14	→	FCP4394	BOSCH				
xDrive 30 d	190	04/14	→	FCP4394	BOSCH				
xDrive 35 d	230	04/14	→	FCP4394	BOSCH				
xDrive 35 i	225	04/14	→	FCP4394	BOSCH				
X5 (E53)									
3.0 d	135	05/01	→	FCP997	ATE				
3.0 d	135	05/01	→			FCP1483	ATE		
3.0 d	160	12/03	→	FCP997	ATE				
3.0 d	160	12/03	→			FCP1483	ATE		
3.0 i	163	05/00	→	FCP997	ATE				
3.0 i	163	05/00	→			FCP1483	ATE		
3.0 i	170	05/00	→	FCP997	ATE				
3.0 i	170	05/00	→			FCP1483	ATE		
4.4 i	210	05/00	→	FCP997	ATE				
4.4 i	210	05/00	→			FCP1483	ATE		
4.4 i	235	05/00	→	FCP997	ATE				
4.4 i	235	05/00	→			FCP1483	ATE		
4.6 is	255	02/02	→			FCP1483	ATE		
4.8 is	265	04/04	→			FCP1483	ATE		
X5 (E70)									
M 50 d	280	08/11	→ 06/13			FCP1672	ATE		
X5 (F15,F85)									
M 50 d	280	07/13	→			FCP1672	ATE		
Z1									
2.5	125	01/88	→ 12/91	FCP660	LUCAS/TRW				
2.5	125	01/88	→ 12/91			FCP850	ATE		
Z3									
1.8	85	10/95	→ 10/98	FCP725	ATE				
1.8	85	10/95	→ 10/98			FCP850	ATE		
2.0	110	04/99	→	FCP1300	ATE				
2.0	110	04/99	→			FCP850	ATE		
2.8	141	04/97	→ 06/00	FCP1300	ATE				
2.8	141	04/97	→ 06/00			FCP850	ATE		
M 3.2	236	03/97	→	FCP779	ATE				
M 3.2	236	03/97	→			FCP578	ATE		
Z3 (E36)									
2.2	125	08/00	→	FCP1300	ATE				
2.2	125	08/00	→			FCP850	ATE		
3.0	170	06/00	→	FCP1300	ATE				
3.0	170	06/00	→			FCP850	ATE		
Z3 Coupe (E36)									
2.8	141	07/97	→ 06/00	FCP1300	ATE				
2.8	141	07/97	→ 06/00			FCP850	ATE		
3.0	170	06/00	→	FCP1300	ATE				
3.0	170	06/00	→			FCP850	ATE		
M 3.2	236, 239	07/97	→	FCP779	ATE				
M 3.2	236, 239	07/97	→			FCP578	ATE		

For material availability see page 16-18 / Per la disponibilità materiali vedere a pagina 16-18



KW



...BMW					NOTE			NOTE
Z3 Roadster (E36)								
1.9 i	103	10/95 → 03/99	FCP725	ATE				
1.9 i	103	10/95 → 03/99				FCP850	ATE	
1.9 i	85	01/99 → 01/03	FCP725	ATE				
1.9 i	85	01/99 → 01/03				FCP850	ATE	
1.9 i	87	07/98 → 01/03	FCP725	ATE				
1.9 i	87	07/98 → 01/03				FCP850	ATE	
Z4 (E85)								
2.0 i	110	05/04 →	FCP1300	ATE				
2.0 i	110	05/04 →				FCP1301	ATE	
2.2 i	125	10/03 →	FCP1300	ATE				
2.2 i	125	10/03 →				FCP1301	ATE	
2.5 i	130	01/06 →	FCP1300	ATE				
2.5 i	130	01/06 →				FCP1301	ATE	
2.5 i	141	02/03 →	FCP1300	ATE				
2.5 i	141	02/03 →				FCP1301	ATE	
2.5 si	160	01/06 →	FCP1300	ATE				
2.5 si	160	01/06 →				FCP1301	ATE	
3.0 i	170	02/03 →	FCP1300	ATE				
3.0 i	170	02/03 →				FCP1301	ATE	
3.0 si	195	01/06 →	FCP1300	ATE				
3.0 si	195	01/06 →				FCP1301	ATE	
Z4 Coupe' (E86)								
3.0 si	195	01/06 →	FCP1300	ATE				
3.0 si	195	01/06 →				FCP1301	ATE	
Z8								
4.9 Z8	294	01/00 → 12/03	FCP1001	ATE				
4.9 Z8	294	01/00 → 12/03				FCP1483	ATE	
4.9 Z8	294	06/00 → 06/03	FCP997	ATE				
4.9 Z8	294	06/00 → 06/03				FCP1483	ATE	
BRISTOL								
Beaufighter								
5.9 (Turbo) 16V	162	01/74 → 12/82	FCP9	LUCAS/TRW				
5.9 (Turbo) 16V	162	01/74 → 12/82				FCP815	LUCAS/TRW	
Brigand								
5.9 16V	162	01/74 → 12/82	FCP9	LUCAS/TRW				
5.9 16V	162	01/74 → 12/82				FCP815	LUCAS/TRW	
Britannia								
5.9 16V		01/74 → 12/82	FCP9	LUCAS/TRW				
5.9 16V		01/74 → 12/82				FCP815	LUCAS/TRW	
BUICK								
Century								
5.7 16V	114	01/73 → 12/76	FRP3057	KELGATE				
Electra								
2.8	86	01/72 → 12/84	FRP3057	KELGATE				
5.0 16V	100, 123	01/72 → 12/84	FRP3057	KELGATE				
5.7 16V	114	01/72 → 12/84	FRP3057	KELGATE				
5.7 16V	125	01/72 → 12/84	FRP3057	KELGATE				
5.7 16V	127	01/72 → 12/84	FRP3057	KELGATE				
Estate Wagon								
5.7 16V	112, 125	01/72 → 12/90	FRP3057	KELGATE				
Le Sabre								
5.0 16V	123	01/72 → 12/85	FRP3057	KELGATE				
5.7 16V	114	01/72 → 12/85	FRP3057	KELGATE				
5.7 16V	125	01/72 → 12/85	FRP3057	KELGATE				
5.7 16V	93	01/72 → 12/85	FRP3057	KELGATE				
6.6 16V	138	01/72 → 12/85	FRP3057	KELGATE				

BUICK

For material availability see page 16-18 / Per la disponibilità materiali vedere a pagina 16-18



KW



...BUICK

Riviera

5.7 16V	118	01/72 → 12/78	FRP3057	KELGATE
5.7 16V	118	01/72 → 12/78	FRP3057	KELGATE
6.6 16V	105	01/72 → 12/78	FRP3057	KELGATE
6.6 16V	105	01/72 → 12/78	FRP3057	KELGATE
7.5 16V	140	01/72 → 12/78	FRP3057	KELGATE
7.5 16V	140	01/72 → 12/78	FRP3057	KELGATE

Roadmaster

5.0 16V	154	01/91 → 12/96	FRP3057	KELGATE
5.7 16V	191	01/91 → 12/96	FRP3057	KELGATE

Royal

5.7 16V		01/73 → 12/76	FRP3057	KELGATE
---------	--	---------------	---------	---------

Skylark

2.8	86	01/76 → 12/79	FRP3057	KELGATE
-----	----	---------------	---------	---------

CADILLAC

ATS

3.6 V	346	09/15 →	FRP3133	BREMBO
-------	-----	---------	---------	--------

ATS Coupe

3.6 V	346	09/15 →	FRP3133	BREMBO
-------	-----	---------	---------	--------

BLS

1.9 D	110	04/06 →			FCP1931	ATE
1.9 D	132	12/07 →			FCP1931	ATE
2.0 T	129	04/06 →			FCP1931	ATE
2.0 T	154	04/06 →			FCP1931	ATE
2.0 T AWD	154	04/06 →			FCP1931	ATE
2.0 T Flexpower	147	12/07 →			FCP1931	ATE
2.8 T	188	04/06 →			FCP1931	ATE
2.8 T AWD	206	10/08 →			FCP1931	ATE

BLS Wagon

1.9 D	110	12/07 →			FCP1931	ATE
1.9 D	132	12/07 →			FCP1931	ATE
2.0 T	129	12/07 →			FCP1931	ATE
2.0 T	154	12/07 →			FCP1931	ATE
2.0 T AWD	154	12/07 →			FCP1931	ATE
2.0 T Flexpower	147	12/07 →			FCP1931	ATE
2.8 T	188	12/07 →			FCP1931	ATE
2.8 T	206	08/10 →			FCP1931	ATE
2.8 T AWD	206	10/08 →			FCP1931	ATE

Brougham

4.1		01/72 → 12/95	FRP3057	KELGATE
5.0		01/72 → 12/95	FRP3057	KELGATE
7.0 16V		01/72 → 12/95	FRP3057	KELGATE
8.2		01/72 → 12/95	FRP3057	KELGATE

Commercial

		01/75 → 12/84	FRP3057	KELGATE
--	--	---------------	---------	---------

CTS

2.0 Turbo	203	09/13 →	FCP1334	BREMBO	Brake Type J55
2.0 Turbo AWD	203	01/14 →	FCP1334	BREMBO	Brake Type J55
6.2	415	01/09 →	FRP3133	BREMBO	

CTS Coupe

6.2 V	415	01/08 →	FRP3133	BREMBO
-------	-----	---------	---------	--------

CTS Sport Wagon

6.2	415	09/11 →	FRP3133	BREMBO
-----	-----	---------	---------	--------

Deville

4.1 16V	92	01/72 → 12/84	FRP3057	KELGATE
6.0 16V	108	01/72 → 12/84	FRP3057	KELGATE
7.0 16V	133	01/72 → 12/84	FRP3057	KELGATE
Heavy duty drum brake		01/90 → 12/98	FCP1213	KELGATE

NOTE

NOTE

For material availability see page 16-18 / Per la disponibilità materiali vedere a pagina 16-18

1066

FERODO

RACING

Updated on 17th Aug 2018

BUICK



KW



...CADILLAC

					NOTE			NOTE
Eldorado								
5.7 16V	130, 136	01/69 → 12/78	FRP3057	KELGATE				
6.0 16V	115	01/69 → 12/78	FRP3057	KELGATE				
7.0 16V	133	01/69 → 12/78	FRP3057	KELGATE				
8.2 16V	140	01/69 → 12/78	FRP3057	KELGATE				
Escalade								
		01/99 → 12/00	FCP1213	KELGATE				
Fleetwood								
5.7 16V	194	01/96 → 12/96	FRP3057	KELGATE				
Fleetwood Brougham								
4.5 16V		01/85 → 12/90	FRP3057	KELGATE				
5.7 16V	175, 194	01/85 → 12/90	FRP3057	KELGATE				
6.0 16V		01/85 → 12/90	FRP3057	KELGATE				
All models		01/90 → 12/93	FCP1213	KELGATE				
Seville								
5.7 16V	66, 136	01/76 → 12/79	FRP3057	KELGATE				
6.0 16V	108	01/76 → 12/79	FRP3057	KELGATE				

CATERHAM

21 models								
Convertible 1.6 i	86	10/94 →	FCP167	LUCAS/TRW				
Convertible 1.6 i	86	10/94 →			FCP408	LUCAS/TRW		
Convertible 1.6 i Supersport	103	10/94 →	FCP167	LUCAS/TRW				
Convertible 1.6 i Supersport	103	10/94 →			FCP408	LUCAS/TRW		
Convertible 1.8 i	140	10/94 →	FCP167	LUCAS/TRW				
Convertible 1.8 i	140	10/94 →			FCP408	LUCAS/TRW		
stock AP up-grade								
		01/97 →	FRP201					
		01/97 →			FCP825	LOCKHEED		
Super Seven								
Convertible 1.4 i	97	01/90 → 12/96	FCP167	LUCAS/TRW				
Convertible 1.4 i	97	01/90 → 12/96			FCP408	LUCAS/TRW		
Convertible 1.4 i	97	01/97 →	FCP809	LUCAS/TRW				
Convertible 1.4 i	97	01/97 →			FCP408	LUCAS/TRW		
Convertible 1.6	74	01/90 → 12/96	FCP167	LUCAS/TRW				
Convertible 1.6	74	01/90 → 12/96			FCP408	LUCAS/TRW		
Convertible 1.6	74	01/97 →	FCP809	LUCAS/TRW				
Convertible 1.6	74	01/97 →			FCP408	LUCAS/TRW		
Convertible 1.6 i	103	01/90 → 12/96	FCP167	LUCAS/TRW				
Convertible 1.6 i	103	01/90 → 12/96			FCP408	LUCAS/TRW		
Convertible 1.6 i	103	01/97 →	FCP809	LUCAS/TRW				
Convertible 1.6 i	103	01/97 →			FCP408	LUCAS/TRW		
Convertible 1.6 Turbo	110	01/90 → 12/96	FCP167	LUCAS/TRW				
Convertible 1.6 Turbo	110	01/90 → 12/96			FCP408	LUCAS/TRW		
Convertible 1.6 Turbo	110	01/97 →	FCP809	LUCAS/TRW				
Convertible 1.6 Turbo	110	01/97 →			FCP408	LUCAS/TRW		
Convertible 1.7	99	01/90 → 12/96	FCP167	LUCAS/TRW				
Convertible 1.7	99	01/90 → 12/96			FCP408	LUCAS/TRW		
Convertible 1.7	99	01/97 →	FCP809	LUCAS/TRW				
Convertible 1.7	99	01/97 →			FCP408	LUCAS/TRW		
Convertible 1.8 i	112	01/98 → 12/01	FCP167	LUCAS/TRW				
Convertible 1.8 i	112	01/98 → 12/01			FCP408	LUCAS/TRW		
Convertible 1.8 i 16v	171	01/99 →	FCP167	LUCAS/TRW				
Convertible 1.8 i 16v	171	01/99 →			FCP408	LUCAS/TRW		
Convertible 2.0i	121	01/90 → 12/96	FCP167	LUCAS/TRW				
Convertible 2.0i	121	01/90 → 12/96			FCP408	LUCAS/TRW		
Convertible 2.0i	121	01/97 →	FCP809	LUCAS/TRW				
Convertible 2.0i	121	01/97 →			FCP408	LUCAS/TRW		

CHEVROLET

For material availability see page 16-18 / Per la disponibilità materiali vedere a pagina 16-18



KW



CHEVROLET

CHEVROLET					NOTE			NOTE
Astra Hatchback								
2.0 DTi	74	08/02 →	FCP1295	ATE				
2.0 DTi	74	08/02 →				FCP1521	LUCAS/TRW	
Astra Saloon								
2.0 DTi GLS	74	08/02 → 12/11	FCP1295	ATE				
2.0 DTi GLS	74	08/02 → 12/11				FCP1521	LUCAS/TRW	
Astra Van								
4.3		01/91 → 12/94	FRP3057	KELGATE				
4.3 not 4WD		01/85 → 12/90	FRP3057	KELGATE				
AVEO Hatchback (T300)								
1.2	51	03/11 →	FCP4262	MANDO				
1.2	63	03/11 →	FCP4262	MANDO				
1.2 LPG	63	11/12 →	FCP4262	MANDO				
1.3 D	55	07/11 →	FCP4262	MANDO				
1.3 D	70	07/11 →	FCP4262	MANDO				
1.4	74	03/11 →	FCP4262	MANDO				
1.4 Turbo	103	08/13 →	FCP4262	MANDO				
1.6	85	03/11 →	FCP4262	MANDO				
AVEO Saloon (T300)								
1.2	51	03/11 →	FCP4262	MANDO				
1.2	63	03/11 →	FCP4262	MANDO				
1.2 LPG	63	11/12 →	FCP4262	MANDO				
1.3 D	55	07/11 →	FCP4262	MANDO				
1.3 D	70	07/11 →	FCP4262	MANDO				
1.4	74	07/11 →	FCP4262	MANDO				
1.6	85	03/11 →	FCP4262	MANDO				
Belair								
		01/69 → 12/72	FRP3057	KELGATE				
Camaro								
6.2	298	01/12 → 12/15	FRP3133	BREMBO				
6.2	318	01/12 → 12/15	FRP3133	BREMBO				
6.2	339	09/15 →	FCP1334	BREMBO	Brake Type J55			
6.2	339	09/15 →	FCP1348	BREMBO				
6.2 (LT1)	333	06/16 →	FCP1334	BREMBO				
6.2L ZL1	485	01/16 → 12/18	FCP5030	BREMBO	Not for vehicles with ceramic discs			
6.2L ZL1	485	01/16 → 12/18				FCP1348	BREMBO	
6.2L ZL1 1LE	485	01/18 →	FCP5030	BREMBO	For vehicles without ceramic discs			
6.2L ZL1 1LE	485	01/18 →				FCP1348	BREMBO	
7.0 Z 28	377	09/14 → 12/15	FCP5030	BREMBO	For vehicles without ceramic discs			
Coupe (1SS & 2SS)		01/10 →	FCP1334	BREMBO				
Coupe (1SS & 2SS)		01/10 →				FCP721	BREMBO	
Camaro Convertible								
6.2	298	01/12 →	FRP3133	BREMBO				
6.2	318	01/12 →	FRP3133	BREMBO				
Camaro,berlinetta,Iroc,Z28								
		01/69 → 12/81	FRP3057	KELGATE				
		01/82 → 12/88	FRP3058	KELGATE				
		01/82 → 12/88				FRP3058	KELGATE	
		01/88 → 12/89	FRP3058	KELGATE				
		01/89 → 12/92	FCP1224	KELGATE				
		01/89 → 12/92	FRP3058	KELGATE				
Caprice								
	112	01/77 → 12/96	FRP3057	KELGATE				
Chevy 2, nova								
		01/79 → 12/84	FRP3057	KELGATE				
		01/85 → 12/88	FCP308	KELGATE				
Corsa Estate								
1.6 GLS	68	08/97 → 07/02	FCP1293	ATE	256mm disc			
1.6 GLS	68	08/97 → 07/02	FCP1295	ATE	280mm disc			
1.6 GLS	68	08/97 → 07/02				FCP1521	LUCAS/TRW	
1.7 D	44	08/00 → 07/02	FCP1293	ATE				
1.7 D	44	08/00 → 07/02				FCP1521	LUCAS/TRW	

For material availability see page 16-18 / Per la disponibilità materiali vedere a pagina 16-18



KW



...CHEVROLET

Corsa Saloon

					NOTE			NOTE
1.6 GLS	68	08/94 → 07/02	FCP1293	ATE	256mm disc			
1.6 GLS	68	08/94 → 07/02	FCP1295	ATE	280mm disc			
1.6 GLS	68	08/94 → 07/02				FCP1521	LUCAS/TRW	
1.6 GS	75	08/97 → 07/02	FCP1293	ATE	256mm disc			
1.6 GS	75	08/97 → 07/02	FCP1295	ATE	280mm disc			
1.6 GS	75	08/97 → 07/02				FCP1521	LUCAS/TRW	
1.7 D	44	08/00 → 07/02	FCP1293	ATE				
1.7 D	44	08/00 → 07/02				FCP1521	LUCAS/TRW	

Corvette

C4		01/88 → 12/96	FCP1224	KELGATE				
C5		01/97 → 12/01	FCP1553	KELGATE				
C5		01/97 → 12/01				FCP1563	KELGATE	
C6 6.0	298	01/04 →	FRP3094	PBR				
C6 6.0	298	01/04 →				FRP3094	PBR	
C7 Stingray (17" & 18" versions)		01/13 →	FCP1334	BREMBO				
C7 Stingray (17" & 18" versions)		01/13 →				FRP3137	BREMBO	
J57		01/16 →	FCP5030	BREMBO	For vehicles without ceramic discs			
ZR1 Package	312	02/08 →	FCP5030	BREMBO	For vehicles without ceramic discs			
ZR1 Package	312	02/08 →				FCP1563	KELGATE	Not for European country vehicles
ZR1 Package	476	09/12 → 12/13	FCP5030	BREMBO	For vehicles without ceramic discs			
ZR1 Package	476	09/12 → 12/13				FCP1563	KELGATE	Not for European country vehicles

Corvette (C6)

C6.R FIA GT3		01/05 →				FRP212	BREMBO	
--------------	--	---------	--	--	--	--------	--------	--

Corvette (C7)

6.2	343	04/14 →	FRP3133	BREMBO	For Z06 equipment			
6.2	343	04/14 →	FCP1334	BREMBO	From 2015, without reinforced brakes			
6.2 Z06	485	09/14 →	FRP3133	BREMBO				

Corvette Convertible (C7)

6.2	335	09/13 →	FRP3133	BREMBO	For Z06 equipment			
6.2	335	09/13 →	FCP1334	BREMBO	From 2015, without reinforced brakes			
6.2	343	04/14 →	FRP3133	BREMBO	For Z06 equipment			
6.2	343	04/14 →	FCP1334	BREMBO	From 2015, without reinforced brakes			

CRUZE (J300)

1.4	103	09/10 →	FCP4262	MANDO				
1.4	74	07/13 →	FCP4262	MANDO				
1.6	80	05/09 →	FCP4262	MANDO				
1.6	83	05/09 →	FCP4262	MANDO				
1.6	86	12/12 →	FCP4262	MANDO				
1.6	89	12/12 →	FCP4262	MANDO				
1.6	91	05/09 →	FCP4262	MANDO				
1.7 D	96	01/12 →	FCP4262	MANDO				
1.7 TD	81	11/13 →	FCP4262	MANDO				
1.8	103	11/09 → 12/13	FCP4262	MANDO				
1.8	104	05/09 →	FCP4262	MANDO				
1.8 LPG	104	06/11 →	FCP4262	MANDO				
2.0 CDI	110	05/09 →	FCP4262	MANDO				
2.0 CDI	90	05/09 →	FCP4262	MANDO				
2.0 CDI	92	05/09 →	FCP4262	MANDO				
2.0 CDI	120	08/10 →	FCP4262	MANDO				

CRUZE Hatchback (J305)

1.6	80	01/12 →	FCP4262	MANDO				
1.6	91	06/11 →	FCP4262	MANDO				
1.7 D	96	01/12 →	FCP4262	MANDO				
1.8	104	06/11 →	FCP4262	MANDO				
1.8 LPG	104	06/11 →	FCP4262	MANDO				
2.0 CDI	110	01/12 →	FCP4262	MANDO				
2.0 CDI	120	06/11 →	FCP4262	MANDO				

CRUZE Station Wagon (J308)

1.4	103	08/12 →	FCP4262	MANDO				
1.6	91	08/12 →	FCP4262	MANDO				
1.7 TD	96	08/12 →	FCP4262	MANDO				
1.8	104	08/12 →	FCP4262	MANDO				
2.0 TD	120	08/12 →	FCP4262	MANDO				

For material availability see page 16-18 / Per la disponibilità materiali vedere a pagina 16-18



KW



CHEVROLET

...CHEVROLET

				NOTE			NOTE
Discayne							
		01/69 → 12/92	FRP3057	KELGATE			
Impala							
		01/69 → 12/92	FRP3057	KELGATE			
Iroc							
		01/69 → 12/81	FRP3057	KELGATE			
Monte Carlo, Malibu							
		01/69 → 12/77	FRP3057	KELGATE			
		01/78 → 12/88	FRP3058	KELGATE			
Vectra (F19)							
3.2	155	09/01 → 03/02	FCP1520	ATE			
3.2	155	09/01 → 03/02			FCP1540	ATE	
Z28							
		01/70 → 12/81	FRP3057	KELGATE			
Z28 single piston							
		01/89 → 12/92	FRP3058	KELGATE			

CHRYSLER

300C							
Car 3.0 CRD	160	06/05 →	FCP1954	BOSCH			
Car 3.5	183	09/04 →	FCP1954	BOSCH			
300C (LX)							
2.7	142	09/04 → 11/12	FCP1954	BOSCH			
5.7 SRT8	250	09/04 → 11/12	FCP1954	BOSCH			
300C Touring							
2.7	142	09/04 → 12/10	FCP1954	BOSCH			
5.7	250	09/04 →	FCP1954	BOSCH			
5.7 AWD	250	04/05 →	FCP1954	BOSCH			
Car 3.0 CRD	160	09/05 →	FCP1954	BOSCH			
Car 3.5	183	09/04 →	FCP1954	BOSCH			
Car 3.5 AWD	183	09/04 →	FCP1954	BOSCH			
Concord							
2.7 LX	149	10/97 → 09/03			FCP1521	LUCAS/TRW	
Crossfire							
3.2 i	160	07/03 →	FCP1050	ATE			
3.2 i SRT-6	246	09/04 →	FCP1050	ATE			
Crossfire (ZH)							
3.2 18v	243	01/05 → 08/06	FCP1001	ATE			

CITROEN

AX							
1.0 10	30, 33	10/86 → 12/98	FCP535	ATE			
1.1 11	40, 44	10/86 → 12/98	FCP535	ATE			
1.1 GT	40, 44	01/89 → 04/91	FCP535	ATE			
1.1 Sport	40, 44	01/88 → 12/91	FCP535	ATE			
1.3 Sport	69	01/88 → 12/91	FCP535	ATE			
1.4 14	48	10/86 → 03/91	FCP535	ATE			
1.4 14	55	04/91 → 07/92	FCP393	BENDIX			
1.4 D	39	01/88 → 04/91	FCP535	ATE			
1.4 D	53	04/91 → 12/97	FCP393	BENDIX			
1.4 GT		09/86 → 10/88	FCP535	ATE			
1.4 GT		11/88 → 04/91	FCP535	ATE			
1.4 i GTi	66, 69	04/91 → 04/97	FCP434	LUCAS/TRW			
1.5 D	42	01/93 → 12/97	FCP393	BENDIX			

For material availability see page 16-18 / Per la disponibilità materiali vedere a pagina 16-18

1070



KW



...CITROEN					NOTE			NOTE
Berlingo								
1.1	44	07/96 → 07/02	FCP1112	LUCAS/TRW				
1.1 i	44	10/01 →	FCP1399	BOSCH				
1.4	55	07/96 → 07/02	FCP1112	LUCAS/TRW				
1.4 i	55	10/01 →	FCP1399	BOSCH				
1.6 i 16V	80	10/00 → 09/01	FCP1112	LUCAS/TRW				
1.7 D		09/96 → 07/02	FCP1112	LUCAS/TRW				
1.8	44	05/97 → 09/01	FCP1112	LUCAS/TRW				
1.8 i	66	05/97 → 09/01	FCP1112	LUCAS/TRW				
1.9 D	51	07/96 → 09/01	FCP1112	LUCAS/TRW				
1.9 D	51	10/01 →	FCP1399	BOSCH				
1.9 D, TD	51	07/96 → 09/01	FCP1112	LUCAS/TRW				
2.0 HDi	66	01/00 → 09/01	FCP1112	LUCAS/TRW				
2.0 HDi	66	10/01 →	FCP1399	BOSCH				
Berlingo Box								
1.6 i 16V	80	10/01 →	FCP1399	BOSCH				
Berlingo Multispace								
1.4	55	07/96 → 07/02	FCP1112	LUCAS/TRW				
1.8	66	09/96 → 07/02	FCP1112	LUCAS/TRW				
1.9 D, TD	51	07/96 → 07/02	FCP1112	LUCAS/TRW				
BX								
1.1	35, 40	09/82 → 12/93	FCP393	BENDIX				
1.5		07/85 → 12/93	FCP393	BENDIX				
1.7 D, RD		07/85 → 12/93	FCP393	BENDIX				
1.8	44, 66	09/82 → 12/93	FCP393	BENDIX				
1.9	70, 75	09/82 → 12/93	FCP393	BENDIX				
1.9 D	47	09/82 → 12/93	FCP393	BENDIX				
1.9 GTi 16V		01/87 → 12/94	FCP393	BENDIX				
1.9 TD	52	09/82 → 12/93	FCP393	BENDIX				
BX (XB-)								
14	47	01/89 → 12/89	FCP393	BENDIX				
14	55	01/89 → 02/93	FCP393	BENDIX				
14 E	52	04/83 → 07/89	FCP393	BENDIX				
14 E	53	04/83 → 02/93	FCP393	BENDIX				
16	53	01/87 → 02/93	FCP393	BENDIX				
16	64	07/85 → 02/93	FCP393	BENDIX				
16	66	10/82 → 06/88	FCP393	BENDIX				
16	76	03/86 → 02/93	FCP393	BENDIX				
BX Break (XB-)								
1.4	52	01/87 → 01/92	FCP393	BENDIX				
14	47	01/89 → 12/89	FCP393	BENDIX				
14	53	01/86 → 02/93	FCP393	BENDIX				
14	55	01/89 → 02/93	FCP393	BENDIX				
16	53	09/88 → 12/94	FCP393	BENDIX				
16	64	07/85 → 12/94	FCP393	BENDIX				
16	66	06/85 → 06/88	FCP393	BENDIX				
16	76	03/86 → 12/94	FCP393	BENDIX				
C-ELYSEE								
1.2 VTi 72	53	11/12 →	FCP1399	Bosch				
1.6 HDi 92	68	11/12 →	FCP1399	Bosch				
1.6 VTi 115	85	11/12 →	FCP1399	Bosch				
C1								
1.0	50	06/05 →	FCP1790	BOSCH				
1.4 HDi	40	06/05 →	FCP1790	BOSCH				
C15								
1.0	30	10/84 → 05/88	FCP393	BENDIX				
1.0	32, 37	05/88 → 07/96	FCP434	LUCAS/TRW				
1.1	35	10/84 → 05/88	FCP393	BENDIX				
1.1	35, 44	05/88 → 10/92	FCP434	LUCAS/TRW				
1.3	47	10/84 → 05/88	FCP393	BENDIX				
1.3 E		05/88 →	FCP434	LUCAS/TRW				
1.4	40	10/84 → 05/88	FCP393	BENDIX				
1.4	44, 49	05/88 → 10/92	FCP434	LUCAS/TRW				
1.8	44	10/84 → 05/88	FCP393	BENDIX				
1.8	44	05/88 → 10/92	FCP434	LUCAS/TRW				

CITROEN

For material availability see page 16-18 / Per la disponibilità materiali vedere a pagina 16-18



KW



...CITROEN

C2

				NOTE			NOTE
1.6 i 16V (Challenge)	09/03 →	FCP1334	BREMBO				
1.6 i 16V (Challenge)	09/03 →				FCP541	LUCAS/TRW	
1.6 i 16V VTS	90 09/03 →	FCP1543	LUCAS/TRW				
1.6 i 16V VTS	90 09/03 →				FCP541	LUCAS/TRW	
1.6 i 16V VTS	90 01/04 →	FCP1399	BOSCH				
1.6 i 16V VTS	90 01/04 →				FCP541	LUCAS/TRW	

C2 (JM_)

1.4	54 09/03 →	FCP1543	LUCAS/TRW				
1.4	55 10/06 →	FCP1543	LUCAS/TRW				
1.4 16V	65 06/06 →	FCP1543	LUCAS/TRW				
1.4 HDi	50 09/03 →	FCP1543	LUCAS/TRW	Not for rim size 16inch			
1.6	80 09/03 →	FCP1543	LUCAS/TRW	Not for rim size 16inch			

C2 ENTERPRISE

1.4 HDi	50 04/09 →	FCP1543	LUCAS/TRW				
---------	------------	---------	-----------	--	--	--	--

C2 R2

1.6 16V (Gravel)	01/09 →	FCP1348	BREMBO				
1.6 16V (Gravel)	01/09 →				FCP809	LUCAS/TRW	
1.6 16V (Tarmac)	01/09 →	FCP1334	BREMBO				
1.6 16V (Tarmac)	01/09 →				FCP809	LUCAS/TRW	

C3 (FC_)

1.4 Bioflex	60 01/09 →	FCP1399	Bosch				
-------------	------------	---------	-------	--	--	--	--

C3 I (FC_)

1.4 16V	65 12/03 →	FCP1543	LUCAS/TRW				
1.4 16V HDi	66 02/02 →	FCP1543	LUCAS/TRW				
1.4 16V HDi	66 02/02 →				FCP541	LUCAS/TRW	
1.6 16V	80 02/02 →	FCP1543	LUCAS/TRW				
1.6 16V	81 05/03 → 05/05	FCP1543	LUCAS/TRW				
1.6 16V HDi	66 10/05 →	FCP1543	LUCAS/TRW				
1.6 16V HDi	66 10/05 →				FCP541	LUCAS/TRW	

C3 II

1.0 VTi 68	50 08/12 →	FCP1399	Bosch				
1.0 VTi 68	50 08/12 →				FCP1491	LUCAS/TRW	
1.1 BiFuel	44 11/10 →	FCP1399	Bosch				
1.2 VTi 82	60 06/12 →	FCP1399	Bosch				
1.2 VTi 82	60 06/12 →				FCP1491	LUCAS/TRW	
1.4	54 11/09 →	FCP1399	Bosch				
1.4 HDi 70	50 11/09 →	FCP1399	Bosch				
1.4 VTi 95	70 11/09 →	FCP1399	Bosch				
1.6 HDi	68 11/09 →	FCP1399	Bosch				
1.6 HDi	68 11/09 →				FCP1491	LUCAS/TRW	
1.6 HDi 110	82 11/09 →	FCP1399	Bosch				
1.6 HDi 110	82 11/09 →				FCP1491	LUCAS/TRW	
1.6 HDi 115	84 09/12 →	FCP1399	Bosch	to Contr.No. 12270			
1.6 HDi 115	84 09/12 →				FCP1491	LUCAS/TRW	
1.6 HDi 90	66 11/09 →	FCP1399	Bosch				
1.6 HDi 90	66 11/09 →				FCP1491	LUCAS/TRW	

C3 Picasso

1.4 VTi 95	70 02/09 →	FCP1399	Bosch				
1.4 VTi 95	70 02/09 →				FCP1491	LUCAS/TRW	
1.4 VTi 95 LPG	70 01/12 →	FCP1399	Bosch				
1.4 VTi 95 LPG	70 01/12 →				FCP1491	LUCAS/TRW	
1.6 HDi	66 02/09 →	FCP1399	Bosch				
1.6 HDi	66 02/09 →				FCP1491	LUCAS/TRW	
1.6 HDi 110	82 05/10 →	FCP1399	Bosch				
1.6 HDi 110	82 05/10 →				FCP1491	LUCAS/TRW	
1.6 HDi 90	68 07/10 →	FCP1399	Bosch				
1.6 HDi 90	68 07/10 →				FCP1491	LUCAS/TRW	

C3 Pluriel (HB_)

1.4	54 05/03 →	FCP1543	LUCAS/TRW				
1.4 HDi	50 04/04 →	FCP1543	LUCAS/TRW				
1.4 HDi	50 04/04 →				FCP541	LUCAS/TRW	
1.4 Hybrid	54 05/05 →	FCP1543	LUCAS/TRW				
1.6	80 05/03 →	FCP1543	LUCAS/TRW				
1.6	80 05/03 →				FCP541	LUCAS/TRW	

For material availability see page 16-18 / Per la disponibilità materiali vedere a pagina 16-18

1072

FERODO

RACING

Updated on 17th Aug 2018

CITROEN



KW



...CITROEN

C4

1.4 i 16V	65	12/04 →	FCP1399	BOSCH		
1.6 HDi 16V	66	12/04 →	FCP1399	BOSCH		
1.6 i 16V	80	12/04 →	FCP1399	BOSCH		

C4 Picasso

2.0 Hdi	100	02/07 →	FCP1641	ATE		
---------	-----	---------	---------	-----	--	--

Dispatch

1.6	58	10/95 →	FCP565	LUCAS/TRW		
1.9 D		10/95 →	FCP565	LUCAS/TRW		
1.9 TD	68	08/96 →	FCP565	LUCAS/TRW		
2.0		01/94 → 07/96	FCP565	LUCAS/TRW		
2.0 TD		08/96 →	FCP565	LUCAS/TRW		

DS3

1.2 VTi 82	60	01/13 →	FCP1399	Bosch	266mm disc		
1.2 VTi 82	60	01/13 →				FCP1491	LUCAS/TRW
1.4 HDi 70	50	04/10 →	FCP1399	BOSCH	266mm disc		
1.4 HDi 70	50	04/10 →				FCP1491	LUCAS/TRW
1.4 VTi 95	70	04/10 →	FCP1399	BOSCH	266mm disc		
1.4 VTi 95	70	04/10 →				FCP1491	LUCAS/TRW
1.4 VTi 95 LPG	70	08/12 →	FCP1399	BOSCH	266mm disc		
1.4 VTi 95 LPG	70	08/12 →				FCP1491	LUCAS/TRW
1.6 HDi 110	82	09/11 →	FCP1399	BOSCH	266mm disc		
1.6 HDi 110	82	09/11 →				FCP1491	LUCAS/TRW
1.6 HDi 90	68	11/09 → 01/10	FCP1399	BOSCH	266mm disc		
1.6 HDi 90	68	11/09 → 01/10				FCP1491	LUCAS/TRW
1.6 Racing	149	02/11 →	FCP1399	BOSCH	266mm disc		
1.6 Racing	149	02/11 →	FCP1348	Brembo			
1.6 Racing	149	02/11 →				FCP1491	LUCAS/TRW
1.6 Racing	152	02/11 →	FCP1348	Brembo			
1.6 Racing	152	02/11 →	FCP1399	BOSCH	266mm disc		
1.6 Racing	152	02/11 →				FCP1491	LUCAS/TRW
1.6 THP 150	110	06/10 →	FCP1399	BOSCH	266mm disc		
1.6 THP 150	110	06/10 →				FCP1491	LUCAS/TRW
1.6 THP 155	115	06/10 →	FCP1348	BREMBO	323mm discs		
1.6 THP 155	115	06/10 →	FCP1399	BOSCH	266mm disc		
1.6 THP 155	115	06/10 →				FCP1491	LUCAS/TRW
1.6 VTi 120	88	06/10 →	FCP1399	BOSCH	266mm disc		
1.6 VTi 120	88	06/10 →				FCP1491	LUCAS/TRW
R1	92	10/12 →	FCP1399	BOSCH			
R1	92	10/12 →				FCP1491	LUCAS/TRW

DS3 Convertible

1.2 VTi 82	60	01/13 →	FCP1399	Bosch	266mm disc		
1.6 HDi 90	69	01/13 →	FCP1399	Bosch	266mm disc		
1.6 HDi 90	69	01/13 →				FCP1491	LUCAS/TRW
1.6 THP 155	115	01/13 →	FCP1399	Bosch	266mm disc		
1.6 THP 155	115	01/13 →	FRP1077	ALCON	4 pist.caliper: 330x30(asphalt) & 300x30(gravell)		
1.6 THP 155	115	01/13 →				FCP1491	LUCAS/TRW
1.6 THP 155	115	01/13 →				FCP809	LUCAS/TRW
1.6 THP 155	115	01/13 →					2 piston caliper:300x8mm discs
1.6 VTi 120	88	01/13 →	FCP1399	Bosch	266mm disc		
1.6 VTi 120	88	01/13 →				FCP1491	LUCAS/TRW

DS3 R5

1.6 EP6 CDT	206	01/14 →	FRP1077	ALCON	4 pist.caliper: 355(asphalt) & 300(gravell)		
1.6 EP6 CDT	206	01/14 →				FRP1077	ALCON
							4 pist.caliper: 355(asphalt) & 300(gravell)

Evasion

1.9 TD	66	10/95 →	FCP565	LUCAS/TRW			
2.0	89	10/95 →	FCP565	LUCAS/TRW			
2.0 (Turbo)	108	10/95 →	FCP565	LUCAS/TRW			
2.0 (Turbo)	108	10/95 →				FCP850	ATE
2.0 HDi	80	09/99 →	FCP565	LUCAS/TRW			
2.0 HDi	80	09/99 →				FCP850	ATE
2.1 TD	80	06/96 →	FCP565	LUCAS/TRW			
2.1 TD	80	06/96 →				FCP850	ATE

Jumpy

1.6 900Kg	58	10/95 →	FCP565	LUCAS/TRW		
1.9 D 900Kg		10/95 →	FCP565	LUCAS/TRW		
1.9 TD 900Kg		10/95 →	FCP565	LUCAS/TRW		
2.0 TD 900 Kg	100	01/00 →	FCP565	LUCAS/TRW		

CITROEN

For material availability see page 16-18 / Per la disponibilità materiali vedere a pagina 16-18



KW



...CITROEN					NOTE			NOTE
LN								
0.6 3 CV	23	08/77 → 10/81	FCP72	BENDIX				
0.7 4 CV	24	10/76 → 08/77	FCP72	BENDIX				
0.7 4 CV	24	08/77 → 10/81	FCP72	BENDIX				
LNA								
0.7		01/76 → 12/79	FCP72	BENDIX				
1.0		01/76 → 12/79	FCP72	BENDIX				
1.1		01/76 → 12/79	FCP72	BENDIX				
Saxo								
1.0	37	02/96 → 04/02	FCP535	ATE				
1.1	40	02/96 → 04/02	FCP535	ATE				
1.1	40	02/96 → 04/02	FCP393	BENDIX				
1.4	55	02/96 → 04/02	FCP393	BENDIX				
1.5 D	42	05/96 → 04/02	FCP393	BENDIX				
1.6	66	02/96 → 04/02	FCP393	BENDIX				
1.6	66	02/96 → 04/02	FCP876	ATE				
1.6 16V	87	02/96 → 04/02	FCP876	ATE				
1.6 16V	87	02/96 → 04/02			FCP558	BENDIX		
1.6 Challenge		02/96 →	FRP218					
1.6 Challenge		02/96 →			FCP558	BENDIX		
1.6 Cup		02/96 → 12/00	FCP1133	LUCAS/TRW				
1.6 Cup		02/96 → 12/00			FCP558	BENDIX		
1.6 Kit car, Super 1600	155	01/97 →	FRP302					
1.6 Kit car, Super 1600	155	01/97 →			FCP810	LUCAS/TRW		
1.6 T4 Trophy		01/00 →	FCP1378	BOSCH				
1.6 T4 Trophy		01/00 →			FCP1378	BOSCH		
Synergie								
1.9 TD	66	10/95 →	FCP565	LUCAS/TRW				
2.0 (Turbo)		10/95 →	FCP565	LUCAS/TRW				
2.0 (Turbo)		10/95 →			FCP850	ATE		
2.0 HDi	80	09/99 →	FCP565	LUCAS/TRW				
2.0 HDi	80	09/99 →			FCP850	ATE		
2.1 TD		01/96 →	FCP565	LUCAS/TRW				
2.1 TD		01/96 →			FCP850	ATE		
Visa								
0.6 / 1.0 / 11 E / 14	25	09/78 → 03/91	FCP253	CITROEN				
0.7	26	09/78 → 12/88	FCP72	BENDIX				
1.0	30	04/81 → 12/88	FCP72	BENDIX				
1.1	35	07/80 → 12/88	FCP72	BENDIX				
1.1	37	07/80 → 12/88	FCP72	BENDIX				
1.1	42	07/80 → 12/88	FCP72	BENDIX				
1.2		01/79 → 12/88	FCP72	BENDIX				
1.4		01/79 → 12/88	FCP72	BENDIX				
1.6		01/79 → 12/88	FCP72	BENDIX				
1.6 i GTi	76, 83	01/85 → 12/88	FCP434	LUCAS/TRW				
1.7 D	44	03/84 → 12/88	FCP434	LUCAS/TRW				
II Super X	47	07/80 → 06/82	FCP253	CITROEN				
Visa Cabriolet								
11 RE	37	03/83 → 10/88	FCP253	CITROEN				
Xsara								
1.4 i Saloon	55	09/00 →	FCP1399	BOSCH				
1.4 i Saloon	55	09/97 → 09/00	FCP1378	BOSCH				
1.4 i Saloon	55	09/97 → 09/00	FCP876	ATE	ABS			
1.4 i Saloon	55	09/97 → 09/00				FCP558	BENDIX	
1.4 i SW Estate	55	09/97 →	FCP1112	LUCAS/TRW	ABS			
1.5 D	42	05/98 → 09/00	FCP1378	BOSCH				
1.5 D Break	42	10/97 → 09/00	FCP1112	LUCAS/TRW				
1.5 D SW Estate	42	05/98 → 09/00	FCP1378	BOSCH				
1.5 D SW Estate	42	05/98 → 09/00	FCP1112	LUCAS/TRW				
1.6 Break	65	10/97 → 09/00	FCP1112	LUCAS/TRW				
1.6 i	66	05/98 → 08/00	FCP876	ATE				
1.6 i	66	05/98 → 08/00				FCP558	BENDIX	
1.6 i Saloon	80	09/00 →	FCP1399	BOSCH				
1.6 i SW Estate	66	05/98 →	FCP876	ATE				
1.8 i Saloon	44	05/98 →	FCP876	ATE				
1.8 i Saloon 16V	82	01/98 →	FCP876	ATE				
1.8 i SW Estate	44	05/98 →	FCP1112	LUCAS/TRW				
1.8 i SW Estate	44	05/98 →				FCP558	BENDIX	
1.9 D Saloon	51	09/00 →	FCP1399	BOSCH				
1.9 D Saloon	51	01/98 → 09/00	FCP876	ATE				
1.9 D Saloon	51	01/98 → 09/00				FCP558	BENDIX	

For material availability see page 16-18 / Per la disponibilità materiali vedere a pagina 16-18



KW



...CITROEN

...Xsara

1.9 TD Saloon	51	01/98 →	FCP876	ATE
1.9 TD Saloon	51	01/98 →		
1.9 TD SW Estate	51	02/98 →	FCP1112	LUCAS/TRW
1.9 TD SW Estate	51	02/98 →		
2.0 HDi Saloon	66	09/00 →	FCP1399	BOSCH
2.0 HDi Saloon, SW Estate	66	01/99 → 09/00	FCP1370	BOSCH
2.0 HDi Saloon, SW Estate	66	01/99 → 09/00	FCP1112	LUCAS/TRW
2.0 HDi Saloon, SW Estate	66	01/99 → 09/00		
2.0 i 16V		09/97 →	FCP1112	LUCAS/TRW
2.0 i 16V		09/97 →		

XSARA (N1)

2.0 16V	100	09/00 → 03/05	FCP1063	LUCAS/TRW
2.0 16V	120	04/97 → 09/00	FCP1063	LUCAS/TRW
2.0 HDi 109	80	05/01 → 03/05	FCP1063	LUCAS/TRW

XSARA Break (N2)

1.9 D SW Estate	51	09/00 →	FCP1112	LUCAS/TRW
2.0 16V	100	09/00 → 08/05	FCP1063	LUCAS/TRW
2.0 HDi 109	80	05/01 → 08/05	FCP1063	LUCAS/TRW

XSARA Coupe (N0)

1.9 D SW Estate	51	09/00 →	FCP1112	LUCAS/TRW
2.0	97	08/98 → 08/00	FCP1063	LUCAS/TRW
2.0 16V	100	09/00 → 03/05	FCP1063	LUCAS/TRW
2.0 HDi 109	80	05/01 → 03/05	FCP1063	LUCAS/TRW
2.0 i 16V	120	02/98 → 03/05	FCP1063	LUCAS/TRW

Xsara Picasso (N68)

1.6	70	10/01 →	FCP1399	BOSCH	for vehicles without ESP
1.6 HDi	66	10/01 →	FCP1399	BOSCH	
1.6 HDi	80	05/04 →	FCP1399	BOSCH	
1.6 i	66	06/00 →	FCP1063	LUCAS/TRW	
1.6 i	66	10/01 →	FCP1399	BOSCH	for vehicles without ESP
1.8 i 16V	85	02/00 →	FCP1063	LUCAS/TRW	
1.8 i 16V	85	10/01 →	FCP1399	BOSCH	
2.0 HDi	66	04/00 →	FCP1063	LUCAS/TRW	
2.0 HDi	66	10/01 →	FCP1399	BOSCH	
2.0 i 16V	100	01/03 →	FCP1467	BOSCH	

ZX

1.1	40, 44	03/91 → 06/92	FCP393	BENDIX	
1.1	40, 44	03/91 → 06/92	FCP845	LUCAS/TRW	
1.1	40, 44	07/92 → 10/97	FCP393	BENDIX	
1.1	40, 44	07/92 → 10/97	FCP845	LUCAS/TRW	
1.4	37, 55	03/91 → 06/92	FCP393	BENDIX	
1.4	37, 55	03/91 → 06/92	FCP845	LUCAS/TRW	
1.4	37, 55	07/92 → 10/97	FCP393	BENDIX	
1.4	37, 55	07/92 → 10/97	FCP845	LUCAS/TRW	
1.6	65, 66	03/91 → 06/92	FCP393	BENDIX	
1.6	65, 66	03/91 → 06/92	FCP845	LUCAS/TRW	
1.6	65, 66	07/92 → 10/97	FCP393	BENDIX	
1.6	65, 66	07/92 → 10/97	FCP845	LUCAS/TRW	
1.8	76, 82	10/92 → 10/97	FCP393	BENDIX	
1.8	76, 82	10/92 → 10/97	FCP845	LUCAS/TRW	
1.8 D	44	10/92 → 10/97	FCP393	BENDIX	
1.8 D	44	10/92 → 10/97	FCP845	LUCAS/TRW	
1.9 D	47	10/91 → 06/92	FCP393	BENDIX	
1.9 D	47	10/91 → 06/92	FCP434	LUCAS/TRW	
1.9 D	47	07/92 → 06/94	FCP434	LUCAS/TRW	
1.9 D	47	07/92 → 06/94	FCP393	BENDIX	
1.9 D SW Estate	47	01/94 → 10/97	FCP434	LUCAS/TRW	
1.9 D SW Estate	47	01/94 → 10/97	FCP393	BENDIX	
1.9 TD Volcane		03/91 → 06/92	FCP393	BENDIX	
1.9 TD Volcane		03/91 → 06/92	FCP845	LUCAS/TRW	
1.9 TD Volcane		03/91 → 06/92			
1.9 TD Volcane		07/92 → 06/94	FCP393	BENDIX	
1.9 TD Volcane		07/92 → 06/94	FCP845	LUCAS/TRW	
1.9 TD Volcane		07/92 → 06/94			
1.9 TD Volcane		07/92 → 06/94	FCP558	BENDIX	ABS
1.9 Volcane		03/91 → 06/92	FCP393	BENDIX	
1.9 Volcane		03/91 → 06/92	FCP845	LUCAS/TRW	
1.9 Volcane		03/91 → 06/92			
1.9 Volcane		07/92 → 06/94	FCP393	BENDIX	
1.9 Volcane		07/92 → 06/94	FCP845	LUCAS/TRW	
1.9 Volcane		07/92 → 06/94			
1.9 Volcane		07/92 → 06/94	FCP558	BENDIX	ABS
2.0 Volcane	89	01/92 → 10/97	FCP845	LUCAS/TRW	

CITROEN

For material availability see page 16-18 / Per la disponibilità materiali vedere a pagina 16-18



KW



...CITROEN

...ZX

2.0 Volcane 89 01/92 → 10/97

FCP558 BENDIX

ZX (N2)

2.0 122 09/96 → 10/97

FCP1063 LUCAS/TRW

2.0 i 16V 110 06/94 → 06/97

FCP1133 LUCAS/TRW

2.0 i 16V 110 06/94 → 06/97

FCP558 BENDIX

2.0 i 16V 112 07/92 → 10/94

FCP1133 LUCAS/TRW

2.0 i 16V 112 07/92 → 10/94

FCP558 BENDIX

2.0 i 16V 120 05/96 → 06/97

FCP1063 LUCAS/TRW

2.0 i 16V 120 05/96 → 06/97

FCP1133 LUCAS/TRW

2.0 i 16V 120 05/96 → 06/97

FCP558 BENDIX

DACIA

Denem

1.3 40 10/82 → 12/85

FCP72 BENDIX

Duster

1.4 48 04/84 → 08/88

FCP72 BENDIX

1.4 48 09/88 →

FCP72 BENDIX

1.6 12/88 →

FCP72 BENDIX

Logan

1.2 16v (LS1N) 55 02/06 →

FCP845 LUCAS/TRW

1.6 16v (LS0L/LS0M) 77 01/06 →

FCP845 LUCAS/TRW

Logan (LS_)

1.4 (LS0A, LS0C, LS0E, LS0G) 55 09/04 →

FCP845 LUCAS/TRW

1.5 dCi (LS0J, LS0Y) 48 09/05 →

FCP845 LUCAS/TRW

1.5 dCi (LS0K) 50 01/06 →

FCP845 LUCAS/TRW

1.5 dCi (LS0W) 63 09/07 →

FCP845 LUCAS/TRW

1.6 8v (LS0B/LS0D/LS0F/LS0H) 64 08/04 →

FCP845 LUCAS/TRW

Nova

1.6 01/96 →

FCP72 BENDIX

Sandero

1.2 16v (BS1N) 55 11/08 →

FCP845 LUCAS/TRW

1.4 55 06/08 →

FCP845 LUCAS/TRW

1.4 MPI LPG 53 01/09 →

FCP845 LUCAS/TRW

1.5 dCi 50 11/08 →

FCP845 LUCAS/TRW

1.6 8v (BS0B/BS0D/BS0F/BS0H) 64 12/07 →

FCP845 LUCAS/TRW

Super Nova

1.4 01/00 →

FCP72 BENDIX

DAEWOO

Espero

1.5 i GLXi 16V 04/95 →

FCP584 ATE

1.8 i CDI 04/95 →

FCP584 ATE

2.0 i CDXi 04/95 →

FCP584 ATE

Korando

2.3 103 01/99 →

FCP600 SUMITOMO

Lanos

1.5 SOHC 09/97 →

FCP732 ATE 13" Wheel

1.6 DOHC 16V 09/97 →

FCP584 ATE 14" Wheel

Nexia

1.5 i GLi 55 04/95 → 08/97

FCP732 ATE

1.5 i GLi 55 04/95 → 08/97

FCP173 GM Far East

1.5 i GLXi 16V 66 04/95 → 08/97

FCP732 ATE

1.5 i GLXi 16V 66 04/95 → 08/97

FCP584 ATE

1.5 i GLXi 16V 66 04/95 → 08/97

FCP173 GM Far East

1.8 i 10/95 → 08/97

FCP732 ATE

For material availability see page 16-18 / Per la disponibilità materiali vedere a pagina 16-18



KW



DAF

55

1.1 34 01/68 → 12/75

FCP3 ATE

NOTE

NOTE

66

1.1 34 01/72 → 12/75

FCP3 ATE

1.3 42 01/72 → 12/75

FCP3 ATE

DAIHATSU

Sirion

1.0, 4WD 40 04/98 →

FCP1501 AKEBONO

1.3 75 09/00 →

FCP1501 AKEBONO

YRV

1.3 i, 4WD 64 02/01 →

FCP1501 AKEBONO

DKW

F12

30 01/63 → 12/65

FCP3 ATE

DODGE

Avenger

All (US) 01/95 →

FCP765 AKEBONO

Light Van

1.1 (UK) 01/76 → 12/83

FCP3 ATE

Stealth

01/91 → 12/96

FCP765 AKEBONO

Viper

8.0 (US) 01/92 → 12/99

FCP721 BREMBO

8.0 (US) 01/92 → 12/99

FCP878 BREMBO

FERRARI

206

01/67 → 12/68

FCP9 LUCAS/TRW

01/67 → 12/68

FCP815 LUCAS/TRW

208

2.0 (Turbo) GTB, GTS 16V 162 01/82 → 12/88

FCP256 ATE

2.0 (Turbo) GTB, GTS 16V 162 01/82 → 12/88

FCP206 ATE

2.0 GTB, GTS 16V 114 04/75 → 07/85

FCP256 ATE

FCP206 ATE

2.0 GTB, GTS 16V 114 04/75 → 07/85

246

2.4 GT 01/71 → 12/75

FCP11 ATE

308

DINO GT4 188 02/74 → 06/80

FCP11 ATE

DINO GT4 188 02/74 → 06/80

FCP2 ATE

GTB 188 09/75 → 06/80

FCP11 ATE

GTB 188 09/75 → 06/80

FCP2 ATE

GTS 188 09/77 → 06/80

FCP11 ATE

GTS 188 09/77 → 06/80

FCP2 ATE

328

3.2 GTB, GTS 16V 198 01/86 → 12/89

FCP256 ATE

3.2 GTB, GTS 16V 198 01/86 → 12/89

FCP206 ATE

For material availability see page 16-18 / Per la disponibilità materiali vedere a pagina 16-18



KW



...FERRARI

348

3.4 TB,TS 32V	221	01/90 → 09/94	FCP451	ATE			
3.4 TB,TS 32V	221	01/90 → 09/94				FCP451	ATE

360 (F131)

3.6 Challenge	305	05/01 → 03/05	FCP1348	BREMBO			
3.6 Challenge	305	05/01 → 03/05				FCP1348	BREMBO
3.6 Challenge Race (pista)	294	03/99 →	FRP3024	BREMBO	Race package		
3.6 Challenge Race (pista)	294	03/99 →				FRP1077	BREMBO
3.6 Challenge Road (Stradale)	313	05/03 → 03/05	FCP1348	BREMBO			Race package
3.6 Challenge Road (Stradale)	313	05/03 → 03/05				FCP1348	BREMBO
3.6 Modena	294	03/99 → 03/05	FCP1348	BREMBO			
3.6 Modena	294	03/99 → 03/05				FCP1348	BREMBO

365

4.4 GTC, GTS	259	01/68 → 12/77	FCP11	ATE			
--------------	-----	---------------	-------	-----	--	--	--

456 GT/GTA

5.5 (F116)	325	01/93 → 06/04	FCP451	ATE			
5.5 (F116)	325	01/93 → 06/04				FCP451	ATE

512

4.9 Boxer B512 i 24V	250	05/86 → 12/87				FCP451	ATE
5.0 24V	250	04/78 → 08/84				FCP451	ATE
5.0 Boxer B512i 24V	250	04/78 → 04/86				FCP451	ATE

550 Barchetta

5.5	357	10/00 → 04/02	FCP541	ATE			
5.5	357	10/00 → 01/05	FCP1298	BREMBO			
5.5	357	10/00 → 01/05				FCP1298	BREMBO

550 Maranello

550	357	09/96 →	FCP1298	BREMBO			
550	357	09/96 →				FCP1298	BREMBO
550	357	10/00 → 04/02	FCP541	ATE			
550	325	09/98 → 12/02	FCP1298	BREMBO			
550	325	09/98 → 12/02				FCP1298	BREMBO

Dino

246 GTB/GTS		01/68 → 12/75	FCP11	ATE			
2.4 Spider, Coupe 18V	152	01/67 → 12/70	FCP9	LUCAS/TRW			

F355

3.5 Berlinetta, GTS, Spider 40V	280	09/94 → 12/96	FCP451	ATE			
3.5 Berlinetta, GTS, Spider 40V	280	09/94 → 12/96				FCP451	ATE
3.5 Berlinetta, GTS, Spider 40V	280	01/96 →	FCP451	ATE			
3.5 Berlinetta, GTS, Spider 40V	280	01/96 →				FCP451	ATE
3.5 Challenge	280	01/96 →	FRP1078	BREMBO			
3.5 Challenge	280	01/96 →				FRP1078	BREMBO

F430

4.3	357	03/08 → 12/09	FCP1348	BREMBO	Cast Iron discs		
4.3	357	03/08 → 12/09				FCP1348	BREMBO
4.3	360	03/05 → 12/09	FCP1348	BREMBO	Cast Iron discs		Cast Iron discs
4.3	360	03/05 → 12/09				FCP1348	BREMBO
4.3	372	09/07 → 12/09	FCP1348	BREMBO	Cast Iron discs		Cast Iron discs
4.3	372	09/07 → 12/09				FCP1348	BREMBO

F512M

4.9 i 48V	324	06/94 → 12/95				FCP451	ATE
-----------	-----	---------------	--	--	--	--------	-----

GTB

2.0 i (Turbo) 16V	187	08/85 → 12/89	FCP256	ATE			
2.0 i (Turbo) 16V	187	08/85 → 12/89				FCP206	ATE

GTS

2.0 i (Turbo) 16V	187	08/85 → 12/89	FCP256	ATE			
2.0 i (Turbo) 16V	187	08/85 → 12/89				FCP206	ATE

Maranello

575M	380	04/02 → 12/06	FCP1298	BREMBO			
575M	380	04/02 → 12/06				FCP1298	BREMBO

For material availability see page 16-18 / Per la disponibilità materiali vedere a pagina 16-18

1078

FERODO

RACING

Updated on 17th Aug 2018

FERRARI



KW



...FERRARI

Mondial

					NOTE			NOTE
2.9 i 16V	158	06/82 → 09/87	FCP256	ATE				
2.9 i 16V	158	06/82 → 09/87				FCP206	ATE	
3.2		01/80 → 09/85	FCP256	ATE				
3.2		01/80 → 09/85				FCP206	ATE	
3.2 i 16V		10/85 → 11/89	FCP256	ATE				
3.2 i 16V		10/85 → 11/89				FCP206	ATE	
3.4 i 32V		10/89 → 12/93	FCP256	ATE				
3.4 i 32V		10/89 → 12/93				FCP206	ATE	

FIAT

124

1.2	48	01/66 → 12/77	FCP29	BENDIX				
1.4	55	01/66 → 12/77	FCP29	BENDIX				
1.6	72	01/66 → 12/77	FCP29	BENDIX				
1.6	74	01/66 → 12/77	FCP29	BENDIX				
1.6	81	01/66 → 12/77	FCP29	BENDIX				
1.6 Spider	77, 99	01/82 → 12/86	FCP370	LUCAS/TRW				
1.8	87, 94	01/66 → 12/79	FCP29	BENDIX				
1.8 Spider	77, 99	01/82 → 12/86	FCP370	LUCAS/TRW				
2.0		01/66 → 12/82	FCP29	BENDIX				
2.0 Spider	77, 99	01/82 → 12/86	FCP370	LUCAS/TRW				

124 Spider

1.4 Multiair	103	09/16 →	FCP4821	BREMBO				
--------------	-----	---------	---------	--------	--	--	--	--

125

1.6	74, 76	01/67 → 12/75	FCP29	BENDIX				
-----	--------	---------------	-------	--------	--	--	--	--

127

0.9	33	01/71 → 12/83	FCP29	BENDIX				
1.0	37	01/71 → 12/83	FCP29	BENDIX				
1.3		01/71 → 12/83	FCP29	BENDIX				
1.3 D	33	01/83 → 12/86	FCP29	BENDIX				

128

1.1	40	01/68 → 12/81	FCP29	BENDIX				
1.3	54	01/68 → 12/81	FCP29	BENDIX				

131

1.3	40, 57	01/74 → 02/84	FCP29	BENDIX				
1.4	51	09/81 → 12/84	FCP29	BENDIX				
1.6	55	10/77 → 08/82	FCP29	BENDIX				
1.6	55	09/82 → 12/84	FCP351	BENDIX				
1.6	63	10/77 → 08/82	FCP29	BENDIX				
1.6	63	09/82 → 12/84	FCP351	BENDIX				
1.6	72	10/77 → 08/82	FCP29	BENDIX				
1.6	72	09/82 → 12/84	FCP351	BENDIX				
2.0	83, 85	10/77 → 08/85	FCP29	BENDIX				
2.4		06/79 → 10/84	FCP29	BENDIX				
2.5 D	53	03/79 → 09/82	FCP29	BENDIX				
2.5 D	53	09/82 → 03/87	FCP351	BENDIX				

131 Mirafiori

1.3 131 Mirafiori	49	06/74 → 12/81	FCP29	BENDIX				
1.4 131 Mirafiori	52	01/82 → 12/83	FCP29	BENDIX				
1.4 131 Mirafiori	54	01/83 → 09/85	FCP351	BENDIX				
1.6 131 Mirafiori	73	06/74 → 12/81	FCP29	BENDIX				
1.6 131 Mirafiori	73	01/83 → 09/85	FCP351	BENDIX				
2.0 131 Mirafiori	44, 84	06/74 → 12/82	FCP29	BENDIX				
2.0 131 Mirafiori	44, 84	01/83 → 09/85	FCP351	BENDIX				
2.4 131 Mirafiori	54	01/82 → 12/83	FCP29	BENDIX				
2.4 131 Mirafiori	54	01/83 → 09/85	FCP351	BENDIX				
2.4 131 Mirafiori	66	06/74 → 12/81	FCP29	BENDIX				
2.5 131 Mirafiori	53	06/78 → 09/82	FCP29	BENDIX				
2.5 131 Mirafiori	53	09/82 → 12/86	FCP351	BENDIX				

132

1.6	72	01/68 → 12/77	FCP29	BENDIX				
1.6	72	01/77 → 08/81	FCP29	BENDIX				
1.6	72	09/81 → 09/82	FCP370	LUCAS/TRW				
1.7	82	11/75 → 05/77	FCP29	BENDIX				
1.7	82	06/77 → 01/79	FCP29	BENDIX				
1.8	81	01/68 → 12/77	FCP29	BENDIX				

For material availability see page 16-18 / Per la disponibilità materiali vedere a pagina 16-18



KW



...FIAT

...132

1.8	81	01/77 → 12/81	FCP29	BENDIX
2.0	82	01/77 → 12/81	FCP29	BENDIX
2.0	88	01/68 → 12/77	FCP29	BENDIX
2.4	66	01/77 → 12/81	FCP29	BENDIX

1500

1.5	55	01/62 → 12/69	FCP9	LUCAS/TRW
-----	----	---------------	------	-----------

1600

1.6		01/62 → 12/65	FCP9	LUCAS/TRW
-----	--	---------------	------	-----------

1800

1.8		07/62 → 12/69	FCP9	LUCAS/TRW
-----	--	---------------	------	-----------

2300

2.3		01/62 → 12/68	FCP9	LUCAS/TRW
-----	--	---------------	------	-----------

500

1.4 16V	74	01/07 →	FCP1466	BOSCH
1.4 16V	74	01/07 →		

FCP1324 LUCAS/TRW

500L

0.9 8V	77	09/12 →	FCP1467	BOSCH
0.9 8V	77	09/12 →		
1.3 D Multijet	62	09/12 →	FCP1467	BOSCH
1.3 D Multijet	62	09/12 →		
1.4 16V	70	09/12 →	FCP1467	BOSCH
1.4 16V	70	09/12 →		

FCP1349 LUCAS/TRW

FCP1349 LUCAS/TRW

FCP1349 LUCAS/TRW

850

0.9 Coupe/Spider/SportSpecial/Super		01/68 → 12/72	FCP29	BENDIX
-------------------------------------	--	---------------	-------	--------

900

0.9 E	33	01/82 →	FCP351	BENDIX
0.9 T,E	33	01/79 → 12/81	FCP29	BENDIX

Argenta

1.6	72	01/81 → 04/83	FCP370	LUCAS/TRW
1.6	72	01/81 → 04/83		
1.6	72	05/83 → 12/86	FCP370	LUCAS/TRW
1.6	72	05/83 → 12/86		
2.0	83	06/78 → 04/83	FCP29	BENDIX
2.0	83	06/78 → 04/83	FCP370	LUCAS/TRW
2.0	83	06/78 → 04/83		
2.0	83	05/83 → 12/85	FCP29	BENDIX
2.0	83	05/83 → 12/85	FCP370	LUCAS/TRW
2.0	83	05/83 → 12/85		
2.0	83	05/83 → 12/85		
2.4	53	01/81 → 04/83	FCP370	LUCAS/TRW
2.4	53	01/81 → 04/83		
2.4	53	05/83 → 12/86	FCP370	LUCAS/TRW
2.4	53	05/83 → 12/86		
2.4 TD Volumex	66	01/83 → 12/86	FCP370	LUCAS/TRW
2.4 TD Volumex	66	01/83 → 12/86		

FCP360 BENDIX

FCP360 BENDIX

FCP360 BENDIX

FCP360 BENDIX

FCP360 BENDIX

FCP360 BENDIX

FCP360 BENDIX

FCP360 BENDIX

Barchetta (183)

1.8 16V	96	04/95 → 05/05	FCP351	BENDIX
1.8 16V	96	04/95 → 05/05		
1.8 16V	96	05/95 → 05/05	FCP370	LUCAS/TRW
1.8 16V	96	06/95 → 05/05	FCP1056	ATE

FCP409 LUCAS/TRW

Brava

1.6 100 16V	76	09/98 → 12/01	FCP1056	ATE	Automatic
1.8 115 16V	83	09/98 → 12/01	FCP1056	ATE	
1.8 16V	83	09/95 → 08/98	FCP1056	ATE	
1.9 JTD 100,105	74	09/98 → 12/01	FCP1056	ATE	
1.9 TD 100	74	09/95 → 08/96	FCP1056	ATE	
1.9 TD 100	74	09/96 → 08/98	FCP1056	ATE	

Bravo

1.6 100 16V	76	09/98 → 12/01	FCP1056	ATE	Automatic
1.8 115 16V	83	09/98 → 12/01	FCP1056	ATE	
1.8 16V	83	09/95 → 08/96	FCP1056	ATE	
1.8 16V	83	09/96 → 08/98	FCP1056	ATE	
1.9 JTD 100,105	74	09/98 → 12/01	FCP1056	ATE	
1.9 TD 100	74	09/95 → 08/98	FCP1056	ATE	

For material availability see page 16-18 / Per la disponibilità materiali vedere a pagina 16-18



KW



...FIAT

...Bravo

1.9 TD 100	74	09/98 → 12/00	FCP1056	ATE
2.0 HGT 155 20V	113	09/98 → 12/01	FCP1052	ATE
2.0 HGT 20V	108	09/95 → 04/97	FCP1052	ATE
2.0 HGT 20V	108	09/95 → 04/97		
2.0 HGT 20V	108	04/97 → 08/98	FCP1052	ATE
2.0 HGT 20V	108	04/97 → 08/98		
2.0 HGT 20V	108	04/97 → 08/98		

Bravo II (198)

1.4 T-Jet	110	09/07 →	FCP1468	BOSCH
1.4 T-Jet	110	09/07 →		

Cinquecento

0.7	22	03/92 → 09/94	FCP925	BENDIX
0.9	29	03/92 → 02/98	FCP925	BENDIX
1.1	40	03/92 → 02/98	FCP925	BENDIX

Cityvan

1.1	42	01/89 →	FCP519	ATE
1.7	44	01/89 →	FCP519	ATE

Coupe (FA/175)

1.8 16V	96	03/96 → 08/00	FCP565	LUCAS/TRW
1.8 16V	96	03/96 → 08/00	FCP1052	ATE
1.8 16V	96	03/96 → 08/00		
2.0 16V	102	11/93 → 08/99	FCP565	LUCAS/TRW
2.0 16V	102	11/93 → 08/99	FCP1052	ATE
2.0 16V	102	11/93 → 08/99		
2.0 16V Turbo	140	11/93 → 08/96	FCP565	LUCAS/TRW
2.0 16V Turbo	140	11/93 → 08/96	FCP1052	ATE
2.0 16V Turbo	140	11/93 → 08/96	FCP1298	BREMBO
2.0 16V Turbo	140	11/93 → 08/96		
2.0 20V	108	08/96 → 04/98	FCP1052	ATE
2.0 20V	108	08/96 → 04/98		
2.0 20V Turbo	162	08/96 → 12/00	FCP721	BREMBO
2.0 20V Turbo	162	08/96 → 12/00	FCP1052	ATE
2.0 20V Turbo	162	08/96 → 12/00	FCP1298	BREMBO
2.0 20V Turbo	162	08/96 → 12/00		

Croma

1.6	62	10/85 → 09/88		
1.9 D	66	10/85 → 09/88		
1.9 D	66	10/85 → 09/88		
1.9 TD		10/85 → 09/88		
1.9 TD		10/85 → 09/88		
2.0 (Turbo)	114	10/85 → 09/88		
2.0 (Turbo)	114	10/85 → 09/88		
2.0 16V	103	01/93 → 03/95	FCP565	LUCAS/TRW
2.0 16V	103	01/93 → 03/95		
2.0 CHT/i.e.	66, 88	10/85 → 09/88		
2.0 CHT/i.e.	66, 88	10/85 → 09/88		
2.5 D	85	10/85 → 09/88		
2.5 D, TD	85	10/85 → 09/88		
2.5 TD	117	10/85 → 09/88		
2.5 TD	117	10/85 → 09/88		
2.5 V6 (Turbo)	118	01/93 → 12/96	FCP565	LUCAS/TRW
2.5 V6 (Turbo)	118	01/93 → 12/96		

Croma (194)

1.8	103	11/05 →	FCP1520	ATE
1.9	100	10/05 → 10/07	FCP1520	ATE
1.9	85	06/05 →	FCP1520	ATE
1.9	88	06/05 →	FCP1520	ATE
1.9	88	04/06 →	FCP1520	ATE
2.2	108	06/05 →	FCP1520	ATE

Doblo

1.2	48	09/00 →	FCP1376	ATE
1.6 i	76	10/01 →	FCP1376	ATE
1.9 D	46	09/00 →	FCP1376	ATE
1.9 JTD	74	07/01 →	FCP1376	ATE

NOTE

NOTE

from Chassis:2060169

For material availability see page 16-18 / Per la disponibilità materiali vedere a pagina 16-18



RACING

Updated on 17th Aug 2018

1081

FIAT



KW



...FIAT

NOTE

NOTE

Doblo Cargo (223)

1.6 i 76 10/01 →

FCP1376 ATE

Duna

1.1 43 01/87 → 12/91

FCP519 ATE

1.3 52 01/87 → 12/91

FCP519 ATE

1.7 D 42 01/87 → 12/89

FCP519 ATE

1.9 01/87 →

FCP519 ATE

Fiorino

1.0 40 01/78 → 12/81

FCP29 BENDIX

1.0 41 12/87 → 08/88

FCP29 BENDIX

1.0 41 09/88 → 08/93

FCP519 ATE

1.1 42 01/88 → 12/92

FCP519 ATE

1.3 48 01/88 → 12/92

FCP519 ATE

1.3 D 38 01/78 → 12/81

FCP29 BENDIX

1.4 49 01/88 → 12/92

FCP519 ATE

1.5 50 01/88 → 12/92

FCP519 ATE

1.6 55 01/88 → 12/92

FCP519 ATE

1.7 D 42 01/88 → 12/92

FCP519 ATE

Grande Punto

1.2 48 09/05 →

FCP1466 BOSCH

1.3 Multijet 55 09/05 →

FCP1466 BOSCH

1.3 Multijet 66 09/05 →

FCP1467 BOSCH

1.9 Multijet 88 09/05 →

FCP1467 BOSCH

1.9 Multijet 88 09/05 →

FCP1858 BOSCH

1.9 Multijet 96 09/05 →

FCP1467 BOSCH

FCP1858 BOSCH

1.9 Multijet 96 09/05 →

FCP1858 BOSCH

Idea

1.9 i Multijet 16V 74 01/04 →

FCP1467 BOSCH

Marea

1.8 115 Berlina 16V 83 01/96 →

FCP1056 ATE

1.8 i 115 Berlina 16V 83 02/97 →

FCP1056 ATE

1.9 JTD 105-110 74 01/99 →

FCP1056 ATE

1.9 TD 100 74 02/97 → 12/99

FCP1056 ATE

1.9 TD 100 74 01/96 → 12/99

FCP1056 ATE

2.0 150 20V 108 01/96 →

FCP1052 ATE

2.0 150 20V 108 01/96 →

FCP409 LUCAS/TRW

2.0 150 20V 108 01/96 →

FCP1113 LUCAS/TRW

2.0 i 150 20V 108 09/96 → 04/99

FCP1052 ATE

2.0 i 150 20V 108 09/96 → 04/99

FCP1113 LUCAS/TRW

2.4 JTD 130 100 01/99 → 12/00

FCP1052 ATE

2.4 JTD 130 100 01/99 → 12/00

FCP1113 LUCAS/TRW

2.4 TD 125 91 01/96 → 04/97

FCP1052 ATE

2.4 TD 125 91 01/96 → 04/97

FCP409 LUCAS/TRW

2.4 TD 125 91 04/97 → 12/99

FCP1052 ATE

2.4 TD 125 91 04/97 → 12/99

FCP1113 LUCAS/TRW

2.4 TD 125 91 04/97 → 12/99

FCP409 LUCAS/TRW

Marea Weekend

1.6 100 16V 76 01/96 →

FCP1056 ATE

1.6 i 100 16V 76 09/96 →

FCP1056 ATE

1.8 115 16V 83 01/96 →

FCP1056 ATE

1.8 i 115 16V 83 09/96 →

FCP1056 ATE

1.9 JTD 105/110 74 04/99 →

FCP1056 ATE

1.9 TD 100 74 02/97 → 12/99

FCP1056 ATE

1.9 TD 100 74 01/96 → 12/99

FCP1056 ATE

2.0 150 20V 108, 113 01/96 →

FCP1052 ATE

2.0 150 20V 108, 113 01/96 →

FCP409 LUCAS/TRW

Marengo

1.9 D 01/97 →

FCP1056 ATE

Multipla

1.6 16V 70 04/02 → 06/10

FCP1052 ATE

1.6 16V 70 04/02 → 06/10

FCP1469 BOSCH

1.6 16V Bipower 76 10/01 → 06/10

FCP1052 ATE

1.6 16V Bipower 76 10/01 → 06/10

FCP1469 BOSCH

1.6 i Bipower 16V 76 04/99 →

FCP1052 ATE

1.6 i Bipower 16V 76 04/99 →

FCP1469 BOSCH

1.6 i 16V 71, 76 08/98 →

FCP1052 ATE

1.6 i 16V 71, 76 08/98 →

FCP1469 BOSCH

1.9 JTD 76 08/98 →

FCP1052 ATE

1.9 JTD 76 08/98 →

FCP1469 BOSCH

For material availability see page 16-18 / Per la disponibilità materiali vedere a pagina 16-18



KW



...FIAT

...Multipla

1.9 JTD	81	07/02 →	FCP1052	ATE				
1.9 JTD	81	07/02 →				FCP1469	BOSCH	

Palio

1.2	55	04/96 →	FCP519	ATE				
1.4	52	07/97 →	FCP519	ATE				
1.6	74	04/96 →	FCP519	ATE				
1.7 TD	51	04/96 →	FCP519	ATE				

Palio Weekend

1.2 i	55	07/97 →	FCP519	ATE				
1.6 i 16V	74	07/97 →	FCP519	ATE				
1.7 TD	51	07/97 →	FCP519	ATE				

Panda (141_)

1000	32	10/82 → 12/95	FCP351	BENDIX				
1000	37	01/85 → 12/92	FCP351	BENDIX				
1000 4x4	32	01/86 → 07/89	FCP351	BENDIX				
1000 4x4	33	05/86 → 12/94	FCP351	BENDIX				
1000 4x4	37	01/86 → 12/92	FCP351	BENDIX				
1000 i	33	01/91 → 02/93	FCP351	BENDIX				
1000 i	33	03/93 → 10/95	FCP351	BENDIX				
1000 i.e. Cat	33	10/87 → 08/98	FCP351	BENDIX				
1100	32	10/82 → 03/93	FCP351	BENDIX				
1100	33	10/82 → 03/93	FCP351	BENDIX				
1100	33	04/93 →	FCP351	BENDIX				
1100	35	10/82 → 03/93	FCP351	BENDIX				
1100	37	10/82 → 03/93	FCP351	BENDIX				
1100	37	01/91 → 08/99	FCP370	LUCAS/TRW				
1100 i	32	01/85 → 12/93	FCP351	BENDIX				
1100 i	33	04/93 → 08/03	FCP351	BENDIX				
1100 i	37	01/91 → 02/93	FCP370	LUCAS/TRW				
1100 i	37	03/93 → 08/99	FCP370	LUCAS/TRW				
1300		01/80 → 04/86	FCP351	BENDIX				
1300 D	27	05/86 → 04/91	FCP351	BENDIX				
1300 i		01/80 → 04/86	FCP351	BENDIX				
700	18	01/80 → 09/82	FCP29	BENDIX				
700	18	10/82 → 06/84	FCP351	BENDIX				
700	18	07/84 → 12/94	FCP351	BENDIX				
700 i	18	01/80 → 09/82	FCP29	BENDIX				
800	25	10/82 → 12/94	FCP351	BENDIX				
800	26	01/80 → 09/82	FCP29	BENDIX				
800 i	26	01/80 → 09/82	FCP29	BENDIX				
900	29	10/82 → 12/95	FCP351	BENDIX				
900	33	01/80 → 09/82	FCP29	BENDIX				
900 i	33	01/80 → 09/82	FCP29	BENDIX				
900 i	29	03/93 → 12/96	FCP351	BENDIX				

PANDA (169)

1.2 4x4	44	10/04 →				FCP1324	LUCAS/TRW	
1.2 4x4	51	11/09 →				FCP1324	LUCAS/TRW	

PANDA (169_)

1.4 100HP	74	10/06 →	FCP1466	BOSCH				
1.4 100HP	74	10/06 →				FCP1324	LUCAS/TRW	

Penny

1.1	42	01/89 →	FCP519	ATE				
1.7	44	01/89 → 12/90	FCP519	ATE				

Punto (176)

1.1	40	09/97 → 08/99	FCP1160	ATE				
1.1	40	09/97 → 08/99	FCP1056	ATE				
1.1 55		11/93 → 08/97	FCP925	BENDIX				
1.1 55		11/93 → 08/97				FCP409	LUCAS/TRW	ABS
1.1 i 55	40	11/93 → 08/99	FCP925	BENDIX				
1.1 i 55	40	11/93 → 08/99				FCP1113	LUCAS/TRW	
1.2 60, 75		11/93 → 08/97	FCP925	BENDIX				
1.2 60, 75		11/93 → 08/97	FCP370	LUCAS/TRW				
1.2 60, 75		11/93 → 08/97				FCP409	LUCAS/TRW	ABS
1.2 60, 75, 16V	43, 44	09/97 → 08/99	FCP1160	ATE				
1.2 60, 75, 16V	43, 44	09/97 → 08/99	FCP1056	ATE				
1.2 60, 75, 16V	43, 44	09/97 → 08/99				FCP409	LUCAS/TRW	ABS
1.2 i 60, 75	44	11/93 → 08/99	FCP370	LUCAS/TRW				
1.2 i 60, 75	44	11/93 → 08/99	FCP925	BENDIX				
1.2 i 60, 75	44	11/93 → 08/99				FCP1113	LUCAS/TRW	

For material availability see page 16-18 / Per la disponibilità materiali vedere a pagina 16-18



KW



...FIAT

...Punto (176)

					NOTE			NOTE
1.2 i 85 16V	54	09/97 → 08/99	FCP1160	ATE				
1.2 i 85 16V	54	09/97 → 08/99				FCP1113	LUCAS/TRW	
1.4 GT		11/93 → 08/97	FCP370	LUCAS/TRW				
1.4 GT		11/93 → 08/97				FCP409	LUCAS/TRW	
1.4 GT	97	09/97 → 08/99	FCP1160	ATE				
1.4 GT	97	09/97 → 08/99	FCP1056	ATE				
1.4 GT	97	09/97 → 08/99				FCP409	LUCAS/TRW	
1.4 i GT	96	09/97 → 08/99	FCP1056	ATE				
1.4 i GT	96	09/97 → 08/99				FCP1113	LUCAS/TRW	
1.4 i GT	98	11/93 → 08/97	FCP370	LUCAS/TRW				
1.4 i GT	98	11/93 → 08/97				FCP1113	LUCAS/TRW	
1.6 90		11/93 → 08/97	FCP370	LUCAS/TRW				
1.6 90		11/93 → 08/97				FCP409	LUCAS/TRW	ABS
1.6 90	66	09/97 → 08/99	FCP1160	ATE				
1.6 90	66	09/97 → 08/99	FCP1056	ATE				
1.6 90	66	09/97 → 08/99				FCP409	LUCAS/TRW	ABS
1.6 i 90		09/97 → 08/99	FCP1160	ATE				
1.6 i 90		09/97 → 08/99				FCP1113	LUCAS/TRW	
1.6 i 90	65	11/93 → 08/97	FCP370	LUCAS/TRW				
1.7 D	42	12/94 → 11/96	FCP925	BENDIX				
1.7 D	46	09/97 → 08/99	FCP1160	ATE				
1.7 D	46	09/97 → 08/99	FCP1056	ATE				
1.7 TD	51, 52	11/93 → 08/97	FCP370	LUCAS/TRW				
1.7 TD	51, 52	11/93 → 08/97				FCP409	LUCAS/TRW	ABS
1.7 TD	51, 52	11/93 → 08/97				FCP1113	LUCAS/TRW	
1.7 TD	51, 52	09/97 → 08/99	FCP1160	ATE				
1.7 TD	51, 52	09/97 → 08/99	FCP1056	ATE				
1.7 TD	51, 52	09/97 → 08/99				FCP409	LUCAS/TRW	ABS
1.7 TD	51, 52	09/97 → 08/99				FCP1113	LUCAS/TRW	

PUNTO (188)

1.2	44	08/99 →	FCP925	BENDIX				
1.2 16V	59	08/99 →	FCP1160	ATE				
1.2 i	44	08/99 → 05/03	FCP925	BENDIX				
1.2 i	44	06/03 →	FCP925	BENDIX				
1.2 i 16V	59	08/99 → 05/03	FCP1160	ATE				
1.2 i 16V	59	06/03 →	FCP1160	ATE				
1.8 i HGT 16V	96	06/03 →	FCP1052	ATE				
1.8 i HGT 130 16V	96	08/99 → 05/03	FCP1376	ATE				
1.8 i HGT 130 16V	96	08/99 → 05/03				FCP1324	LUCAS/TRW	
1.9 JTD	80	08/99 →	FCP1056	ATE				
1.9 JTD	74	06/03 →	FCP1052	ATE				

Regata

1.3 70, 75	49	11/83 → 09/90	FCP351	BENDIX				
1.5 85	60	11/83 → 04/90	FCP351	BENDIX				
1.5 85	60	11/83 → 04/90	FCP370	LUCAS/TRW				
1.6 85, 100	60, 74	11/83 → 09/90	FCP370	LUCAS/TRW				
1.7 D	43, 44	11/83 → 04/90	FCP370	LUCAS/TRW				
1.9 D	48	11/83 → 09/90	FCP370	LUCAS/TRW				
1.9 TD	59	11/83 → 09/90	FCP370	LUCAS/TRW				
2.0 TD	59	05/86 → 07/89	FCP370	LUCAS/TRW				

Ritmo

1.0 60	44	09/78 → 09/82	FCP29	BENDIX				
1.1 60	42, 44	09/82 → 12/88	FCP351	BENDIX				
1.1 60	44	09/78 → 08/82	FCP29	BENDIX				
1.3 65, 70	48, 50	09/78 → 08/82	FCP29	BENDIX				
1.3 65, 70	48, 50	09/82 → 12/88	FCP351	BENDIX				
1.5 75, 85		09/78 → 12/79	FCP29	BENDIX				
1.5 75, 85	55, 63	01/80 → 08/82	FCP29	BENDIX				
1.5 75, 85	55, 63	09/82 → 12/88	FCP351	BENDIX				
1.6 90, 105	77	09/78 → 02/83	FCP29	BENDIX				
1.6 90, 105	77	09/78 → 02/83	FCP351	BENDIX				
1.6 90, 105	77	03/83 → 06/88	FCP351	BENDIX				
1.6 90, 105	77	03/83 → 06/88	FCP370	LUCAS/TRW				
1.7 D	41	01/81 → 08/82	FCP29	BENDIX				
1.7 D	41	09/82 → 02/83	FCP351	BENDIX				
1.7 D	41	03/83 → 06/88	FCP351	BENDIX				
1.7 TD	44	01/81 → 08/82	FCP29	BENDIX				
1.7 TD	44	09/82 → 02/83	FCP351	BENDIX				
1.7 TD	44	03/83 → 06/88	FCP351	BENDIX				
1.9 D	41	01/84 → 06/88	FCP370	LUCAS/TRW				
1.9 TD	44	01/84 → 06/88	FCP370	LUCAS/TRW				
2.0 125, 130	81, 96	09/78 → 02/83	FCP72	BENDIX				
2.0 125, 130	81, 96	09/78 → 02/83	FCP370	LUCAS/TRW				
2.0 125, 130	81, 96	03/83 → 06/88	FCP72	BENDIX				

For material availability see page 16-18 / Per la disponibilità materiali vedere a pagina 16-18



KW

**...FIAT****...Ritmo**

2.0 125, 130

81, 96 03/83 → 06/88

FCP370 LUCAS/TRW

NOTE

NOTE

Scudo

1.9 JTD

81 01/00 →

FCP565 LUCAS/TRW

1.9 JTD

81 01/00 →

FCP850 ATE

Seicento

0.9

29 03/98 →

FCP925 BENDIX

1.1

40 03/98 →

FCP925 BENDIX

Siena

1.2

55 04/96 →

FCP519 ATE

1.4

52 07/97 →

FCP519 ATE

1.6 16V

74 04/96 →

FCP519 ATE

STILO (192)

1.2 i 16V

59 09/01 →

FCP1466 BOSCH

1.2 i 16V

59 09/01 →

FCP1469 BOSCH

1.6 i 16V

76 09/01 →

FCP1466 BOSCH

1.6 i 16V

76 09/01 →

FCP1469 BOSCH

1.8 16V

98 09/01 →

FCP1467 BOSCH

1.8 16V

98 09/01 →

FCP1469 BOSCH

1.9 JTD

103 01/04 → 11/06

FCP1467 BOSCH

1.9 JTD

103 01/04 → 11/06

FCP1469 BOSCH

1.9 JTD 115

85 09/01 →

FCP1467 BOSCH

1.9 JTD 115

85 09/01 →

FCP1469 BOSCH

1.9 JTD 80

59 09/01 →

FCP1467 BOSCH

1.9 JTD 80

59 09/01 →

FCP1469 BOSCH

2.4 20V

125 09/01 →

FCP1468 BOSCH

2.4 20V

125 09/01 →

FCP1469 BOSCH

STILO Multi Wagon (192)

1.6 i

76 11/02 →

FCP1467 BOSCH

1.6 i

76 11/02 →

FCP1469 BOSCH

1.8 i

96 11/02 →

FCP1467 BOSCH

1.8 i

96 11/02 →

FCP1469 BOSCH

1.9 JTD

59 01/03 → 08/08

FCP1467 BOSCH

1.9 JTD

59 01/03 → 08/08

FCP1469 BOSCH

1.9 JTD

85 01/03 → 08/08

FCP1467 BOSCH

1.9 JTD

85 01/03 → 08/08

FCP1469 BOSCH

Strada

1.1 60

40 05/83 → 12/87

FCP351 BENDIX

1.3 65, 70

48, 50 01/78 → 12/81

FCP29 BENDIX

1.3 65, 70

48, 50 01/83 → 01/88

FCP351 BENDIX

1.5 85, Super

63 01/80 → 12/82

FCP29 BENDIX

1.5 85, Super

63 05/83 → 01/88

FCP370 LUCAS/TRW

1.6 105

77 09/81 → 07/85

FCP370 LUCAS/TRW

Tempra

1.4

51 05/90 → 07/96

FCP524 LUCAS/TRW

1.4

51 05/90 → 07/96

FCP370 LUCAS/TRW ABS

1.4

51 05/90 → 07/96

FCP409 LUCAS/TRW ABS

1.6

55 04/90 → 07/96

FCP524 LUCAS/TRW

1.6

55 04/90 → 07/96

FCP370 LUCAS/TRW ABS

1.6

55 04/90 → 07/96

FCP409 LUCAS/TRW ABS

1.6

57 04/90 → 07/96

FCP524 LUCAS/TRW

1.6

57 04/90 → 07/96

FCP370 LUCAS/TRW ABS

1.6

57 04/90 → 07/96

FCP409 LUCAS/TRW ABS

1.6

66 04/90 → 07/96

FCP524 LUCAS/TRW

1.6

66 04/90 → 07/96

FCP370 LUCAS/TRW ABS

1.6

66 04/90 → 07/96

FCP409 LUCAS/TRW ABS

1.9 D

48 05/90 → 07/96

FCP524 LUCAS/TRW

1.9 D

48 05/90 → 07/96

FCP370 LUCAS/TRW ABS

1.9 D

48 05/90 → 07/96

FCP409 LUCAS/TRW ABS

1.9 TD

59 02/91 → 07/96

FCP370 LUCAS/TRW

1.9 TD

59 02/91 → 07/96

FCP409 LUCAS/TRW ABS

1.9 TD

66 02/91 → 07/96

FCP370 LUCAS/TRW

1.9 TD

66 02/91 → 07/96

FCP409 LUCAS/TRW ABS

2.0

85 04/90 → 06/93

FCP370 LUCAS/TRW

2.0

85 04/90 → 06/93

FCP409 LUCAS/TRW ABS

2.0 16V

83 01/93 → 07/96

FCP565 LUCAS/TRW

2.0 16V

83 01/93 → 07/96

FCP409 LUCAS/TRW

2.0 S. America only

85 01/92 → 07/96

FCP519 ATE

For material availability see page 16-18 / Per la disponibilità materiali vedere a pagina 16-18



KW



...FIAT

TEMPRA (159_)

1.8 i.e. (159.AN)	77	03/92 → 08/96
1.8 i.e. (159.AN)	77	03/92 → 08/96
1.8 i.e. (159.AV)	76	09/93 → 08/96
1.8 i.e. (159.AV)	76	09/93 → 08/96
1.8 i.e. (159.AZ)	66	09/93 → 08/96
1.8 i.e. (159.AZ)	66	09/93 → 08/96
1.8 i.e. (159.BY)	74	10/94 → 08/96
1.8 i.e. (159.BY)	74	10/94 → 08/96

TEMPRA S.W. (159_)

1.8 i.e. (159.AN)	77	03/92 → 12/93
1.8 i.e. (159.AN)	77	03/92 → 12/93
1.8 i.e. (159.AV)	76	09/93 → 08/96
1.8 i.e. (159.AV)	76	09/93 → 08/96
1.8 i.e. (159.AZ)	66	09/93 → 08/96
1.8 i.e. (159.AZ)	66	09/93 → 08/96
1.8 i.e. (159.BY)	74	10/94 → 08/96
1.8 i.e. (159.BY)	74	10/94 → 08/96

Tipo

1.1	41	02/88 → 12/91
1.1	41	02/88 → 12/91
1.1	41	02/88 → 12/91
1.1	41	01/92 → 12/96
1.1	41	01/92 → 12/96
1.1	41	01/92 → 12/96
1.4	51, 52	02/88 → 02/93
1.4	51, 52	02/88 → 02/93
1.4	51, 52	02/88 → 02/93
1.4	51, 52	03/93 → 12/96
1.4	51, 52	03/93 → 12/96
1.4	51, 52	03/93 → 12/96
1.7 D	42	02/88 → 02/93
1.7 D	42	02/88 → 02/93
1.7 D	42	02/88 → 02/93
1.7 D	42	03/93 → 12/95
1.7 D	42	03/93 → 12/95
1.7 D	42	03/93 → 12/95
1.8 i.e. 16V	100	11/89 → 12/92
1.8 i.e. 16V	100	11/89 → 12/92
1.9 D	48	01/88 → 04/93
1.9 D	48	01/88 → 04/93
1.9 D	48	05/93 → 12/95
1.9 D	48	05/93 → 12/95
1.9 TD	59, 66	02/88 → 02/93
1.9 TD	59, 66	02/88 → 02/93
1.9 TD	59, 66	02/88 → 02/93
1.9 TD	59, 66	03/93 → 12/95
1.9 TD	59, 66	03/93 → 12/95
1.9 TD	59, 66	03/93 → 12/95
2.0	85	06/90 → 12/91
2.0	85	06/90 → 12/91
2.0 16V	107	01/91 → 12/95
2.0 16V	107	01/91 → 12/95

TIPO (160_)

1.6 (160.AE)	61	01/88 → 10/91
1.6 (160.AE)	61	01/88 → 10/91
1.6 (160.AE)	61	01/88 → 10/91
1.6 i.e.	66	02/88 → 05/91
1.6 i.e.	66	02/88 → 05/91
1.6 i.e.	66	02/88 → 05/91
1.6 i.e. (160.A1, 160.EC, 160.EB)	55	10/92 → 04/95
1.6 i.e. (160.A1, 160.EC, 160.EB)	55	10/92 → 04/95
1.6 i.e. (160.A1, 160.EC, 160.EB)	55	10/92 → 04/95
1.6 i.e. (160.AF)	57	07/90 → 01/93
1.6 i.e. (160.AF)	57	07/90 → 01/93
1.6 i.e. (160.AF)	57	07/90 → 01/93
1.8 i.e.	66	09/93 → 04/95
1.8 i.e.	66	09/93 → 04/95
1.8 i.e. (160.AY)	77	10/90 → 06/93
1.8 i.e. (160.AY)	77	10/90 → 06/93
1.8 i.e. (160.ED)	76	04/93 → 04/95
1.8 i.e. (160.ED)	76	04/93 → 04/95
1.8 i.e. (160.EQ, 160.AM)	74	10/94 → 10/95
1.8 i.e. (160.EQ, 160.AM)	74	10/94 → 10/95
2.0 i.e. (160.AJ)	80	06/90 → 03/92

NOTE

NOTE

FCP370 LUCAS/TRW

FCP370 LUCAS/TRW

FCP370 LUCAS/TRW

FCP370 LUCAS/TRW

FCP370 LUCAS/TRW

FCP370 LUCAS/TRW

FCP370 LUCAS/TRW

FCP370 LUCAS/TRW

FCP370 LUCAS/TRW

FCP370 LUCAS/TRW

FCP524 LUCAS/TRW

FCP370 LUCAS/TRW

FCP524 LUCAS/TRW

FCP370 LUCAS/TRW

FCP370 LUCAS/TRW

FCP524 LUCAS/TRW

FCP370 LUCAS/TRW

FCP524 LUCAS/TRW

FCP370 LUCAS/TRW

FCP524 LUCAS/TRW

FCP370 LUCAS/TRW

FCP524 LUCAS/TRW

FCP370 LUCAS/TRW

FCP524 LUCAS/TRW

FCP370 LUCAS/TRW

FCP524 LUCAS/TRW

FCP370 LUCAS/TRW

FCP524 LUCAS/TRW

FCP370 LUCAS/TRW

FCP524 LUCAS/TRW

FCP370 LUCAS/TRW

FCP524 LUCAS/TRW

FCP370 LUCAS/TRW

FCP524 LUCAS/TRW

FCP370 LUCAS/TRW

FCP524 LUCAS/TRW

FCP370 LUCAS/TRW

FCP524 LUCAS/TRW

FCP370 LUCAS/TRW

FCP524 LUCAS/TRW

FCP370 LUCAS/TRW

FCP565 LUCAS/TRW

FCP370 LUCAS/TRW

FCP565 LUCAS/TRW

FCP524 LUCAS/TRW

FCP370 LUCAS/TRW

FCP524 LUCAS/TRW

FCP370 LUCAS/TRW

FCP524 LUCAS/TRW

FCP370 LUCAS/TRW

FCP524 LUCAS/TRW

FCP370 LUCAS/TRW

FCP524 LUCAS/TRW

FCP370 LUCAS/TRW

FCP524 LUCAS/TRW

FCP370 LUCAS/TRW

FCP524 LUCAS/TRW

FCP370 LUCAS/TRW

FCP524 LUCAS/TRW

FCP370 LUCAS/TRW

FCP524 LUCAS/TRW

FCP370 LUCAS/TRW

FCP524 LUCAS/TRW

FCP370 LUCAS/TRW

FCP565 LUCAS/TRW

FCP409 LUCAS/TRW

FCP409 LUCAS/TRW

FCP409 LUCAS/TRW

FCP409 LUCAS/TRW

FCP409 LUCAS/TRW

FCP409 LUCAS/TRW

FCP409 LUCAS/TRW

FCP409 LUCAS/TRW

FCP409 LUCAS/TRW

FCP409 LUCAS/TRW

FCP409 LUCAS/TRW

FCP409 LUCAS/TRW

FCP409 LUCAS/TRW

FCP409 LUCAS/TRW

FCP409 LUCAS/TRW

FCP409 LUCAS/TRW

FCP409 LUCAS/TRW

FCP409 LUCAS/TRW

FCP409 LUCAS/TRW

FCP409 LUCAS/TRW

FCP409 LUCAS/TRW

FCP409 LUCAS/TRW

FCP409 LUCAS/TRW

FCP409 LUCAS/TRW

FCP409 LUCAS/TRW

FCP409 LUCAS/TRW

FCP409 LUCAS/TRW

FCP409 LUCAS/TRW

FCP409 LUCAS/TRW

FCP409 LUCAS/TRW

FCP409 LUCAS/TRW

FCP409 LUCAS/TRW

FCP409 LUCAS/TRW

FCP409 LUCAS/TRW

FCP409 LUCAS/TRW

FCP409 LUCAS/TRW

FCP409 LUCAS/TRW

FCP409 LUCAS/TRW

FCP409 LUCAS/TRW

FCP409 LUCAS/TRW

For material availability see page 16-18 / Per la disponibilità materiali vedere a pagina 16-18



1086

FERODO

RACING

Updated on 17th Aug 2018

FIAT

KW 			 !		 !		
...FIAT				NOTE			NOTE
...TIPO (160_)							
2.0 i.e. (160.AJ)	80	06/90 → 03/92				FCP596	LUCAS/TRW
2.0 i.e. (160.AT, 160.AJ)	83	03/90 → 04/95	FCP565	LUCAS/TRW			
2.0 i.e. (160.AT, 160.AJ)	83	03/90 → 04/95				FCP596	LUCAS/TRW
2.0 i.e. 16V Sport (160.EF)	102	03/93 → 04/95	FCP565	LUCAS/TRW			
2.0 i.e. 16V Sport (160.EF)	102	03/93 → 04/95				FCP596	LUCAS/TRW
Ulysse							
1.8 i	73	04/96 →	FCP565	LUCAS/TRW			
1.8 i	73	04/96 →				FCP850	ATE
1.9 JTD	66	10/95 →	FCP565	LUCAS/TRW			
1.9 JTD	66	10/95 →				FCP850	ATE ABS
2.0	89	01/95 →	FCP565	LUCAS/TRW			
2.0	89	01/95 →				FCP850	ATE ABS
2.0 (Turbo)	108	01/95 →	FCP565	LUCAS/TRW			
2.0 (Turbo)	108	01/95 →				FCP850	ATE
2.0 JTD	80	06/99 →	FCP565	LUCAS/TRW			
2.0 JTD	80	06/99 →				FCP850	ATE
2.1 TD	80	01/94 →	FCP565	LUCAS/TRW			
2.1 TD	80	01/94 →				FCP850	ATE
Uno							
0.9 45	30	01/83 → 12/94	FCP351	BENDIX			
0.9 45	33	01/83 → 12/94	FCP351	BENDIX			
0.9 45	34	01/83 → 12/94	FCP351	BENDIX			
0.9 i 45	33	01/93 → 12/94	FCP351	BENDIX			
1.0 45	32	01/83 → 12/94	FCP351	BENDIX			
1.0 i	33	06/91 → 12/94	FCP351	BENDIX			
1.0 i 45	32	01/93 → 12/94	FCP351	BENDIX			
1.1 50, 55, 60	37, 40	01/83 → 12/94	FCP351	BENDIX			
1.1 i	37	06/91 → 12/94	FCP351	BENDIX			
1.1 i	40	01/83 → 05/91	FCP351	BENDIX			
1.1 i 50, 55, 60	37, 40	01/93 → 12/94	FCP351	BENDIX			
1.1 van		01/88 → 12/94	FCP370	LUCAS/TRW			
1.1 van		01/88 → 12/94	FCP519	ATE			
1.3 (Turbo)	77, 78	03/83 → 01/90	FCP370	LUCAS/TRW			
1.3 (Turbo)	77, 78	03/83 → 01/90				FCP409	LUCAS/TRW
1.3 70	48, 50	01/83 → 12/94	FCP351	BENDIX			
1.3 i 70	48	01/93 → 12/94	FCP351	BENDIX			
1.4 (Turbo)	82	01/90 → 12/94	FCP370	LUCAS/TRW			
1.4 (Turbo)	82	01/90 → 12/94				FCP409	LUCAS/TRW
1.4 70	51	01/83 → 12/94	FCP351	BENDIX			
1.4 i	52, 82	06/91 → 12/94	FCP351	BENDIX			
1.4 i 70	51	01/93 → 12/94	FCP351	BENDIX			
1.4 i Selecta		01/93 → 12/94	FCP370	LUCAS/TRW			
1.4 Selecta		10/87 → 12/94	FCP370	LUCAS/TRW			
1.4 TD	52	10/86 → 10/90	FCP351	BENDIX			
1.5 75	55	10/85 → 12/94	FCP351	BENDIX			
1.5 i	55	06/91 → 12/94	FCP351	BENDIX			
1.7 D	42	01/93 → 12/94	FCP370	LUCAS/TRW			
1.7 D	42	01/93 → 12/94	FCP351	BENDIX			
1.7 D	43	06/91 → 12/94	FCP351	BENDIX			
1.7 D, TD	42	04/86 → 12/94	FCP370	LUCAS/TRW			
1.7 D, TD	42	04/86 → 12/94	FCP351	BENDIX			
1.9 D, TD	59	01/85 → 12/94	FCP370	LUCAS/TRW			
All CS (Brazil)		01/88 → 12/91	FCP519	ATE			
X1/9							
1.3	54, 55	10/72 → 12/81	FCP29	BENDIX			
1.5	56, 63	01/77 → 03/89	FCP29	BENDIX			
FIAT AUTO POLAND							
Cinquecento							
0.7		03/92 →	FCP925	BENDIX			
0.9		03/92 →	FCP925	BENDIX			
1.1		03/92 →	FCP925	BENDIX			
Palio							
1.2 l	54	04/96 →	FCP519	ATE			
1.6 l	78	04/96 →	FCP519	ATE			

FIAT AUTO POLAND

For material availability see page 16-18 / Per la disponibilità materiali vedere a pagina 16-18



KW



...FIAT AUTO POLAND

				NOTE		NOTE
Palio Weekend						
1.2 i		07/97 →	FCP519	ATE		
1.6 i 16V		07/97 →	FCP519	ATE		
Seicento						
0.9		03/98 →	FCP925	BENDIX		
1.1		03/98 →	FCP925	BENDIX		
Siena						
1.2		04/96 →	FCP519	ATE		
1.6		04/96 →	FCP519	ATE		

FORD

B-Max						
1.0 EcoBoost	74	10/12 →	FCP4612	LUCAS/TRW		
1.0 EcoBoost	88	10/12 →	FCP4612	LUCAS/TRW		
1.0 EcoBoost	92	12/12 →	FCP4612	LUCAS/TRW		
1.4	66	10/12 →	FCP4612	LUCAS/TRW		
1.5 TDCi	55	10/12 →	FCP4612	LUCAS/TRW		
1.6 TDCi	70	10/12 →	FCP4612	LUCAS/TRW		
1.6 Ti	77	10/12 →	FCP4612	LUCAS/TRW		

C-MAX						
1.6	74	02/07 →			FCP1931	ATE
1.6 TDCi	66	02/07 →			FCP1931	ATE
1.6 TDCi	74	02/07 →			FCP1931	ATE
1.6 TDCi	80	02/07 →			FCP1931	ATE
1.8	90	02/07 →			FCP1931	ATE
1.8	92	02/07 →			FCP1931	ATE
1.8 Flexifuel	92	02/07 →			FCP1931	ATE
1.8 TDCi	85	02/07 →			FCP1931	ATE
2.0	107	02/07 →			FCP1931	ATE
2.0 CNG	107	04/09 →			FCP1931	ATE
2.0 LPG	107	06/08 →			FCP1931	ATE
2.0 TDCi	100	02/07 →			FCP1931	ATE
2.0 TDCi	81	02/08 →			FCP1931	ATE
2.0 TDCi	98	02/07 →			FCP1931	ATE

C-MAX II						
1.0 EcoBoost	74	10/12 →			FCP1931	ATE
1.0 EcoBoost	92	10/12 →			FCP1931	ATE
1.6 EcoBoost	110	12/10 →			FCP1931	ATE
1.6 EcoBoost	134	12/10 →			FCP1931	ATE
1.6 Flexifuel	88	02/11 →			FCP1931	ATE
1.6 TDCi	70	12/10 →			FCP1931	ATE
1.6 TDCi	85	12/10 →			FCP1931	ATE
1.6 Ti	63	12/10 →			FCP1931	ATE
1.6 Ti	77	12/10 →			FCP1931	ATE
1.6 Ti	92	12/10 →			FCP1931	ATE
2.0 TDCi	100	02/11 →			FCP1931	ATE
2.0 TDCi	103	02/11 →			FCP1931	ATE
2.0 TDCi	120	12/10 →			FCP1931	ATE
2.0 TDCi	85	02/11 →			FCP1931	ATE

Capri						
1.3		05/73 → 12/75	FCP810	LUCAS/TRW		
1.3	37	01/69 → 05/73	FCP810	LUCAS/TRW		
1.3	42	01/76 → 12/83	FCP167	LUCAS/TRW		
1.3 GT	37, 44	01/69 → 12/71	FCP810	LUCAS/TRW		
1.3 GT	44	01/72 → 05/73	FCP167	LUCAS/TRW		
1.5		01/68 → 12/72	FCP167	LUCAS/TRW		
1.6	51, 56	01/72 → 12/75	FCP167	LUCAS/TRW		
1.6	56	01/69 → 12/71	FCP167	LUCAS/TRW		
1.6	66	01/76 → 12/83	FCP167	LUCAS/TRW		
1.6	66	01/84 → 12/88	FCP167	LUCAS/TRW		
1.7		01/68 → 08/69	FCP810	LUCAS/TRW		
2.0	66	01/69 → 12/71	FCP167	LUCAS/TRW		
2.0	74	01/72 → 12/75	FCP167	LUCAS/TRW		
2.0	74	01/76 → 12/83	FCP167	LUCAS/TRW		
2.0	74	01/84 → 12/88	FCP167	LUCAS/TRW		
2.3		01/78 → 12/85	FCP167	LUCAS/TRW		
2.3	79	01/74 → 12/77	FCP167	LUCAS/TRW		
2.8	118	01/78 → 12/81	FCP167	LUCAS/TRW		
2.8	118	01/82 → 12/88	FCP167	LUCAS/TRW		

For material availability see page 16-18 / Per la disponibilità materiali vedere a pagina 16-18



KW

**...FORD****...Capri**

3.0	102	01/76 → 12/83	FCP167	LUCAS/TRW			
3.0	102, 125	01/72 → 12/75	FCP167	LUCAS/TRW			

Consul

2.0 V4	74	01/72 → 12/75	FCP167	LUCAS/TRW			
2.5 V6	92	01/72 → 12/75	FCP167	LUCAS/TRW			

Cortina

1.2	38	01/65 → 07/65	FCP809	LUCAS/TRW			
1.2	38	07/65 → 12/66	FCP810	LUCAS/TRW			
1.3	46	01/63 → 12/70	FCP810	LUCAS/TRW			
1.3	41	01/71 → 05/74	FCP167	LUCAS/TRW			
1.3	41	06/74 → 12/82	FCP167	LUCAS/TRW			
1.3	42	06/74 → 12/82	FCP167	LUCAS/TRW			
1.3	44	06/74 → 12/82	FCP167	LUCAS/TRW			
1.5	47	01/63 → 12/64	FCP167	LUCAS/TRW			
1.5	47	01/65 → 07/65	FCP809	LUCAS/TRW			
1.5	47	07/65 → 12/66	FCP810	LUCAS/TRW			
1.5	47	01/67 → 12/70	FCP810	LUCAS/TRW			
1.6		01/71 → 05/74	FCP167	LUCAS/TRW			
1.6	53, 66	06/74 → 12/79	FCP167	LUCAS/TRW			
1.6	55	01/80 → 12/82	FCP167	LUCAS/TRW			
1.6	66	01/67 → 12/70	FCP810	LUCAS/TRW			
1.6 E, GT	66	01/66 → 12/70	FCP810	LUCAS/TRW			
1.6 GT, SW Estate	53	01/71 → 05/74	FCP167	LUCAS/TRW			
2.0	73, 74	01/71 → 12/79	FCP167	LUCAS/TRW			
2.0	74	01/80 → 12/82	FCP167	LUCAS/TRW			
2.3	79	01/76 → 12/79	FCP167	LUCAS/TRW			
2.3	84	01/80 → 12/82	FCP167	LUCAS/TRW			

Cougar

2.0 16V	96	08/98 → 12/01	FCP766	ATE			
2.5 V6 24V	125	08/98 → 12/01	FCP766	ATE			

Courier

1.3 50		01/96 → 01/00	FCP1081	ATE			
1.3 50	37, 44	10/91 → 01/96	FCP206	ATE			
1.3 i	50	02/00 →	FCP1394	ATE			
1.4 16V	65	05/96 →	FCP1081	ATE			
1.8 D	50	02/00 →	FCP1394	ATE			
1.8 D 50		02/96 → 01/00	FCP1081	ATE			
1.8 D 50	44, 55	10/91 → 01/96	FCP206	ATE			
1.8 TDi	50	02/00 →	FCP1394	ATE			

Escort (1)

1.1 SW Estate	33	01/69 → 12/70	FCP809	LUCAS/TRW			
1.1 SW Estate	33	01/71 → 12/74	FCP809	LUCAS/TRW			
1.3		01/69 → 12/70	FCP809	LUCAS/TRW			
1.3		01/71 → 12/74	FCP809	LUCAS/TRW			
1.3 GT, SW Estate	42, 44	01/69 → 12/70	FCP809	LUCAS/TRW			
1.3 GT, SW Estate	42, 44	01/71 → 12/74	FCP809	LUCAS/TRW			
1.6 TC, Mexico, RS		01/72 → 12/74	FCP167	LUCAS/TRW			
2.0 RS	81	01/72 → 05/73	FCP167	LUCAS/TRW			
2.0 RS	81	06/73 → 12/74	FCP167	LUCAS/TRW			

Escort (2)

1.1	33	01/75 → 12/80	FCP167	LUCAS/TRW			
1.3	40, 42	01/75 → 08/80	FCP167	LUCAS/TRW			
1.3 Sport, Ghia	51	01/75 → 08/80	FCP167	LUCAS/TRW			
1.6		01/75 → 08/80	FCP167	LUCAS/TRW			
1.8 RS1800 16V	115	01/75 → 08/80	FCP167	LUCAS/TRW			
2.0 RS2000 16V	110	01/75 → 12/80	FCP276	ATE			

Escort (3)

1.1	37	07/80 → 02/83	FCP206	ATE			
1.1	37	03/83 → 12/85	FCP206	ATE			
1.3	51	09/80 → 02/83	FCP206	ATE			
1.3	51	03/83 → 12/85	FCP206	ATE			
1.4	55	08/80 → 12/85	FCP206	ATE			
1.6	58, 71	09/80 → 02/83	FCP206	ATE			
1.6	58, 71	03/83 → 12/86	FCP206	ATE			
1.6 D	40	08/80 → 11/85	FCP206	ATE			
1.6 i XR3i, Cabrio	77	01/80 → 09/82	FCP206	ATE			
1.6 i XR3i, Cabrio	77	10/82 → 01/85	FCP206	ATE			
1.6 RS Turbo	97	02/85 → 12/86	FCP276	ATE			
1.6 RS1600 (Turbo)	77	11/82 → 12/86	FCP206	ATE			

For material availability see page 16-18 / Per la disponibilità materiali vedere a pagina 16-18



KW

**...FORD**

NOTE

NOTE

Escort (4)

1.1	40	01/86 → 08/90	FCP206	ATE
1.3	44	01/86 → 08/90	FCP206	ATE
1.4	55	01/86 → 12/90	FCP206	ATE
1.6		01/86 → 10/90	FCP206	ATE
1.6 D	40	01/86 → 03/89	FCP206	ATE
1.6 i XR3i, Cabrio	77, 80	02/85 → 09/90	FCP206	ATE
1.6 RS Turbo	97	01/87 → 08/90	FCP276	ATE
1.8 D		09/88 → 10/90	FCP206	ATE

Escort (5)

1.3 i	44	07/90 → 09/92	FCP617	BENDIX
1.3 Sedan/SW Estate	44	01/90 → 08/97	FCP617	BENDIX
1.4 i	54	10/90 → 03/93	FCP617	BENDIX
1.4 Sedan/SW Estate	54	01/90 → 08/97	FCP617	BENDIX
1.6 i	63	10/90 →	FCP617	BENDIX
1.6 i	66	10/90 →	FCP617	BENDIX
1.6 i	77	10/90 →	FCP617	BENDIX
1.6 Sedan/SW Estate	63	01/90 → 08/97	FCP617	BENDIX
1.6 Sedan/SW Estate	66	01/90 → 08/97	FCP617	BENDIX
1.6 Sedan/SW Estate	77	01/90 → 08/97	FCP617	BENDIX
1.8 i XR3i 16V	77	01/91 → 12/94	FCP617	BENDIX
1.8 i XR3i 16V	96	01/91 → 12/94	FCP276	ATE
1.8 Sedan/SW Estate	44	10/90 → 08/97	FCP617	BENDIX
1.8 TD	44	10/90 → 08/97	FCP617	BENDIX
2.0 RS Cosworth 16V + 4x4	162	09/91 → 08/97	FCP685	ATE
2.0 RS Cosworth 16V + 4x4	162	09/91 → 08/97		
2.0 RS2000 16V	110	09/91 → 08/97	FCP276	ATE

Escort (6)

1.3 i	44	09/92 → 01/95	FCP617	BENDIX
1.3 i SW Estate	44	01/94 → 08/97	FCP617	BENDIX
1.4 i	54	04/93 → 12/94	FCP617	BENDIX
1.4 i SW Estate	54	01/94 → 08/97	FCP617	BENDIX
1.6 i	63	09/92 →	FCP617	BENDIX
1.6 i	66	01/92 → 08/97	FCP617	BENDIX
1.6 i	77	09/92 →	FCP617	BENDIX

Escort (7)

1.3 i	44	01/95 → 10/98	FCP617	BENDIX
1.4	55	08/97 → 12/99	FCP617	BENDIX
1.4 i	54	01/95 → 08/97	FCP617	BENDIX
1.6 16V	66	08/97 →	FCP617	BENDIX
1.6 i	63	01/95 →	FCP617	BENDIX
1.6 i	63	01/95 →	FCP617	BENDIX
1.6 i	66	01/95 →	FCP617	BENDIX
1.6 i	77	01/95 →	FCP617	BENDIX
1.8	77	08/97 → 12/99	FCP617	BENDIX
1.8	85	08/97 → 12/99	FCP617	BENDIX
1.8	96	08/97 → 12/99	FCP617	BENDIX
1.8 D	44	01/95 → 08/97	FCP617	BENDIX
1.8 i 16V		01/96 → 08/97	FCP276	ATE
1.8 i 16V		08/97 → 12/99	FCP276	ATE
1.8 TD		08/97 →	FCP617	BENDIX

Escort Van

1.1	30, 35	01/75 → 12/77	FCP167	LUCAS/TRW
1.1	33	09/76 → 08/80	FCP167	LUCAS/TRW
1.1	40	09/80 → 12/90	FCP206	ATE
1.3	44	09/76 → 08/80	FCP167	LUCAS/TRW
1.3	44	09/80 → 12/90	FCP206	ATE
1.4	40	09/80 → 12/90	FCP206	ATE
1.4 40, 60		01/91 → 08/97	FCP617	BENDIX
1.4 40, 60		09/97 →	FCP617	BENDIX
1.4 55, 75	55	01/95 →	FCP617	BENDIX
1.4 i 40, 60		04/93 → 08/97	FCP617	BENDIX
1.4 i 55, 75	55	04/93 → 08/97	FCP617	BENDIX
1.6		09/80 → 12/90	FCP206	ATE
1.6 40, 60		01/91 → 08/97	FCP617	BENDIX
1.6 40, 60		09/97 →	FCP617	BENDIX
1.6 i 55, 75		01/95 → 08/97	FCP617	BENDIX
1.8 D		09/80 → 12/90	FCP206	ATE
1.8 D 40, 60		04/93 → 08/97	FCP617	BENDIX
1.8 D 40, 60		01/91 → 12/99	FCP617	BENDIX
1.8 D 55		01/95 → 08/97	FCP617	BENDIX
1.8 TD 75		09/97 → 12/99	FCP617	BENDIX

For material availability see page 16-18 / Per la disponibilità materiali vedere a pagina 16-18

1090

FERODO

RACING

Updated on 17th Aug 2018



KW



...FORD					NOTE			NOTE
Fiesta								
1.6 R5 rally (asphalt & gravel)	01/13 →	FRP3140	AP RACING					
1.6 R5 rally (asphalt & gravel)	01/13 →	FRP3087	BREMBO					
1.6 R5 rally (asphalt & gravel)	01/13 →				FRP3140	AP RACING		
1.6 R5 rally (asphalt & gravel)	01/13 →				FRP3087	BREMBO		
Fiesta (1)								
1.6 XR2	71 12/81 → 09/83	FCP206	ATE					
Fiesta (2)								
1.6 XR2	71 10/83 → 01/89	FCP206	ATE					
Fiesta (3)								
0.9	03/89 → 12/96	FCP1082	ATE					
1.0	03/89 → 12/96	FCP206	ATE					
1.1	50 04/89 → 12/96	FCP1082	ATE					
1.1	50 04/89 → 12/96	FCP206	ATE	ALB				
1.3	44 08/91 → 12/95	FCP1082	ATE					
1.3	44 08/91 → 12/95	FCP206	ATE	ALB				
1.4	54, 55 04/89 → 10/95	FCP1082	ATE					
1.4	54, 55 04/89 → 10/95	FCP206	ATE	ALB				
1.6 i	131 04/89 → 12/95	FCP206	ATE					
1.6 i 16V	131 01/93 → 12/95	FCP206	ATE					
1.6 i XR2i, 1.6S, RS (Turbo)	77, 96 04/89 → 03/92	FCP206	ATE					
1.8 16V	96 04/89 → 12/95	FCP206	ATE					
1.8 D	44 04/89 → 12/95	FCP1082	ATE	Solid				
1.8 D (+ SCS)	44 04/89 → 12/95	FCP206	ATE	Vented				
1.8 Si 16V	77 01/92 → 12/95	FCP206	ATE					
1.8 XR2, RS Turbo 16V	96 04/89 → 12/95	FCP206	ATE					
Fiesta (4)								
1.2 16V	55 01/96 → 01/00	FCP1082	ATE	Solid				
1.2 16V	55 01/96 → 01/00	FCP1081	ATE	Vented				
1.2 i 16V	02/00 → 10/01	FCP1394	ATE					
1.25 i 16V	55 01/96 → 01/00	FCP1082	ATE					
1.25 i 16V	55 01/96 → 01/00	FCP1081	ATE					
1.25 i 16V	55 02/00 → 10/01	FCP1394	ATE					
1.3	44 01/96 → 01/00	FCP1082	ATE	Solid				
1.3	44 01/96 → 01/00	FCP1081	ATE	Vented				
1.3 i	37 02/00 → 10/01	FCP1394	ATE					
1.4 16V	65 01/96 → 01/00	FCP1082	ATE	Solid				
1.4 16V	65 01/96 → 01/00	FCP1081	ATE	Vented				
1.4 i 16V	66 02/00 →	FCP1394	ATE					
1.6 i 16V	76 02/00 → 10/01	FCP1394	ATE					
1.8 D	44 01/96 → 01/00	FCP1082	ATE	Solid				
1.8 D	44 01/96 → 01/00	FCP1081	ATE	Vented				
1.8 TDi	55 02/00 → 10/01	FCP1394	ATE					
Fiesta (5)								
1.3 i	51 11/01 →	FCP1394	ATE					
1.4 i 16V	59 11/01 →	FCP1394	ATE					
1.4 TDCi	50 11/01 →	FCP1394	ATE					
1.6 i 16V	74 11/01 →	FCP1394	ATE					
2.0 ST150	110 01/05 →	FCP1568	ATE					
2.0 ST150	110 01/05 →				FCP1319	LUCAS/TRW		
R2 (Asphalt)	120 10/09 →	FRP3116	AP RACING	Asphalt				
R2 (Asphalt)	120 10/09 →				FCP1540	ATE		
R2 (Gravel)	120 10/09 →	FRP3097	AP RACING	285mm disc				
R2 (Gravel)	120 10/09 →				FCP1540	ATE		
Fiesta (6)								
1.0	48 01/13 →	FCP4612	LUCAS/TRW					
1.0	59 10/12 →	FCP4612	LUCAS/TRW					
1.0 EcoBoost	74 01/13 →	FCP4612	LUCAS/TRW					
1.0 EcoBoost	92 09/12 →	FCP4612	LUCAS/TRW					
1.2 16V	44 08/08 →	FCP4426	LUCAS/TRW					
1.2 16V	60 08/08 →	FCP4426	LUCAS/TRW					
1.4 16V	68 01/09 →	FCP4426	LUCAS/TRW					
1.4 16V	71 10/08 →	FCP4426	LUCAS/TRW					
1.4 TDCi 16V	50 08/08 →	FCP4426	LUCAS/TRW					
1.5 TDCi	55 09/12 →	FCP4612	LUCAS/TRW					
1.6 16V	88 10/08 →	FCP4426	LUCAS/TRW					
1.6 ST	134 03/13 →	FCP4612	LUCAS/TRW	For 278mm brake discs				
1.6 ST	134 03/13 →				FCP1319	LUCAS/TRW		
1.6 TDCi 16V	55 02/09 →	FCP4426	LUCAS/TRW					
1.6 TDCi 16V	66 08/08 →	FCP4426	LUCAS/TRW					
1.6 TDCi 8V	70 03/10 →	FCP4426	LUCAS/TRW					

FORD

For material availability see page 16-18 / Per la disponibilità materiali vedere a pagina 16-18



KW



...FORD

...Fiesta (6)

1.6 Ti 77 09/12 → FCP4612 LUCAS/TRW

Fiesta (7)

1.0 EcoBoost 74 01/17 → FCP4816 ATE
 1.0 EcoBoost 92 01/17 → FCP4816 ATE
 1.1 51 01/17 → FCP4816 ATE
 1.1 63 01/17 → FCP4816 ATE
 1.5 TDCi 63 01/17 → FCP4816 ATE
 1.5 TDCi 88 01/17 → FCP4816 ATE

Fiesta Van

1.1 37 04/89 → 01/96 FCP1082 ATE
 1.1 37 04/89 → 01/96 FCP206 ATE
 1.3 44 04/89 → 01/96 FCP1082 ATE
 1.3 44 04/89 → 01/96 FCP206 ATE
 1.3 i 35 44 01/96 → FCP1081 ATE
 1.3 i 35 44 01/96 → FCP1082 ATE
 1.4 i 66 01/96 → 10/99 FCP1081 ATE
 1.4 i 66 01/96 → 10/99 FCP1082 ATE
 1.8 D 44 04/89 → 01/96 FCP1082 ATE
 1.8 D 44 04/89 → 01/96 FCP206 ATE
 1.8 D 35 44 01/96 → FCP1081 ATE
 1.8 D 35 44 01/96 → FCP1082 ATE

Fiesta Van (6)

1.2 16V 60 08/08 → FCP4426 LUCAS/TRW
 1.4 TDCi 16V 50 08/08 → FCP4426 LUCAS/TRW
 1.5 TDCi 55 10/12 → FCP4612 LUCAS/TRW
 1.6 TDCi 16V 66 08/08 → FCP4426 LUCAS/TRW
 1.6 TDCi 8V 70 02/10 → FCP4426 LUCAS/TRW

FOCUS C-MAX

1.6 74 10/03 → 03/07 FCP1931 ATE
 1.6 TDCi 66 02/05 → 03/07 FCP1931 ATE
 1.6 TDCi 80 10/03 → 03/07 FCP1931 ATE
 1.6 Ti 85 08/04 → 03/07 FCP1931 ATE
 1.8 88 10/03 → 03/07 FCP1931 ATE
 1.8 92 04/04 → 03/07 FCP1931 ATE
 1.8 Flexifuel 92 01/06 → 03/07 FCP1931 ATE
 1.8 TDCi 85 01/05 → 03/07 FCP1931 ATE
 2.0 107 03/04 → 03/07 FCP1931 ATE
 2.0 TDCi 100 10/03 → 03/07 FCP1931 ATE
 2.0 TDCi 98 10/03 → 03/07 FCP1931 ATE

FOCUS Estate (DNW)

ST170 127 09/02 → 11/04 FCP1568 ATE

FOCUS I (DAW, DBW)

1.4 16V 55 08/98 → 11/04 FCP1318 ATE
 1.6 16V 74 08/98 → 11/04 FCP1318 ATE
 1.8 16V 85 08/98 → 11/04 FCP1318 ATE
 1.8 16V 85 08/98 → 11/04 FCP541 LUCAS/TRW
 1.8 TDCi 85 10/01 → 11/04 FCP1318 ATE
 1.8 TDCi 85 10/01 → 11/04 FCP1319 LUCAS/TRW
 1.8 TDDi 66 08/98 → 11/04 FCP1318 ATE
 2.0 16V 96 10/98 → 11/04 FCP1318 ATE
 2.0 16V 96 10/98 → 11/04 FCP541 LUCAS/TRW
 2.0 RS 158 10/02 → 11/04 FCP1348 BREMBO
 2.0 RS 158 10/02 → 11/04 FCP1568 ATE
 2.0 RS 158 10/02 → 11/04 FCP1319 LUCAS/TRW
 2.0 ST170 127 03/02 → 10/04 FCP1568 ATE
 2.0 ST170 127 03/02 → 10/04 FCP1319 LUCAS/TRW
 WRC specs (asphalt spec) 223 10/98 → 12/07 FRP3113 BREMBO 8-pot

FOCUS II (DA_)

1.4 59 11/04 → FCP1931 ATE
 1.6 74 11/04 → FCP1931 ATE
 1.6 LPG 85 10/09 → FCP1931 ATE
 1.6 TDCi 66 01/05 → FCP1931 ATE
 1.6 TDCi 74 11/04 → FCP1931 ATE
 1.6 TDCi 80 11/04 → FCP1931 ATE
 1.6 Ti 85 11/04 → FCP1931 ATE
 1.8 92 03/06 → FCP1931 ATE
 1.8 Flexifuel 92 01/06 → FCP1931 ATE
 1.8 Flexifuel 96 12/05 → FCP1931 ATE
 1.8 TDCi 85 01/05 → FCP1931 ATE

NOTE

NOTE

For material availability see page 16-18 / Per la disponibilità materiali vedere a pagina 16-18



KW

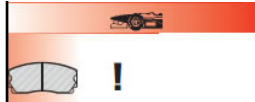

...FORD

...FOCUS II (DA_)

2.0	107	11/04 →
2.0 CNG	107	04/09 →
2.0 LPG	107	06/08 →
2.0 TDCi	100	11/04 →
2.0 TDCi	81	02/08 →
2.0 TDCi	98	11/04 →
2.5 RS	224	01/09 →
2.5 RS	224	01/09 →
2.5 ST	166	10/05 →
2.5 ST	166	10/05 →

FCP4044	LUCAS/TRW
FCP1706	ATE

FCP1931	ATE
FCP1931	ATE
FCP1931	ATE
FCP1931	ATE
FCP1931	ATE
FCP1931	ATE
FCP1917	LUCAS/TRW
FCP1931	ATE

FOCUS II Convertible

1.6	74	10/06 →
2.0	107	10/06 →
2.0 TDCi	100	10/06 →

FCP1931	ATE
FCP1931	ATE
FCP1931	ATE

FOCUS II Estate (DA_)

1.4	59	11/04 →
1.6	74	11/04 →
1.6 LPG	85	10/09 →
1.6 TDCi	66	11/04 →
1.6 TDCi	74	11/04 →
1.6 TDCi	80	11/04 →
1.6 TDCi	81	12/07 →
1.6 Ti	85	11/04 →
1.8	92	03/06 →
1.8 Flexifuel	92	01/06 →
1.8 Flexifuel	97	12/05 →
1.8 TDCi	85	11/04 →
2.0	107	11/04 →
2.0 LPG	107	06/08 →
2.0 TDCi	100	11/04 →
2.0 TDCi	81	02/08 →
2.0 TDCi	98	11/04 →

FCP1931	ATE
FCP1931	ATE
FCP1931	ATE
FCP1931	ATE
FCP1931	ATE
FCP1931	ATE
FCP1931	ATE
FCP1931	ATE
FCP1931	ATE
FCP1931	ATE
FCP1931	ATE
FCP1931	ATE
FCP1931	ATE
FCP1931	ATE
FCP1931	ATE
FCP1931	ATE
FCP1931	ATE

FOCUS II Saloon (DA_)

1.4	59	04/05 →
1.6	74	04/05 →
1.6 TDCi	66	04/05 →
1.6 TDCi	74	04/05 →
1.6 TDCi	80	04/05 →
1.6 Ti	85	04/05 →
1.8	92	03/06 →
1.8 Flexifuel	92	06/06 →
1.8 Flexifuel	96	12/05 →
1.8 TDCi	85	04/05 →
2.0	107	04/05 →
2.0 TDCi	100	04/05 →
2.0 TDCi	81	02/08 →

FCP1931	ATE
FCP1931	ATE
FCP1931	ATE
FCP1931	ATE
FCP1931	ATE
FCP1931	ATE
FCP1931	ATE
FCP1931	ATE
FCP1931	ATE
FCP1931	ATE
FCP1931	ATE
FCP1931	ATE
FCP1931	ATE

FOCUS III

1.0 EcoBoost	74	02/12 →
1.0 EcoBoost	92	02/12 →
1.6 EcoBoost	110	04/11 →
1.6 EcoBoost	134	04/11 →
1.6 Flexifuel	88	04/11 →
1.6 LPG	88	02/12 →
1.6 TDCi	70	04/11 →
1.6 TDCi	85	04/11 →
1.6 Ti	63	08/11 →
1.6 Ti	77	04/11 →
1.6 Ti	92	04/11 →
2.0 ST	184	07/12 →
2.0 ST	184	07/12 →
2.0 TDCi	100	04/11 →
2.0 TDCi	103	04/11 →
2.0 TDCi	120	04/11 →
2.0 TDCi	85	04/11 →
2.3 RS AWD	257	07/15 →
2.3 RS AWD	257	07/15 →

FCP4416	ATE	brake disc diameter 320mm
FCP4830	BREMBO	

FCP1931	ATE
FCP1931	ATE
FCP1931	ATE
FCP1931	ATE
FCP1931	ATE
FCP1931	ATE
FCP1931	ATE
FCP1931	ATE
FCP1931	ATE
FCP1931	ATE
FCP1931	ATE
FCP1931	ATE
FCP1931	ATE
FCP1931	ATE
FCP1931	ATE
FCP1931	ATE
FCP1931	ATE
FCP1931	ATE

FORD

For material availability see page 16-18 / Per la disponibilità materiali vedere a pagina 16-18



KW



...FORD

					NOTE			NOTE
FOCUS III Saloon								
1.0 EcoBoost	74	02/12 →				FCP1931	ATE	
1.0 EcoBoost	92	02/12 →				FCP1931	ATE	
1.6 EcoBoost	110	04/11 →				FCP1931	ATE	
1.6 EcoBoost	134	04/11 →				FCP1931	ATE	
1.6 Flexifuel	88	04/11 →				FCP1931	ATE	
1.6 TDCi	70	04/11 →				FCP1931	ATE	
1.6 TDCi	85	04/11 →				FCP1931	ATE	
1.6 Ti	63	08/11 →				FCP1931	ATE	
1.6 Ti	77	04/11 →				FCP1931	ATE	
1.6 Ti	92	04/11 →				FCP1931	ATE	
2.0 TDCi	100	04/11 →				FCP1931	ATE	
2.0 TDCi	103	04/11 →				FCP1931	ATE	
2.0 TDCi	120	04/11 →				FCP1931	ATE	
2.0 TDCi	85	04/11 →				FCP1931	ATE	
FOCUS III Turnier								
1.0 EcoBoost	74	02/12 →				FCP1931	ATE	
1.0 EcoBoost	92	02/12 →				FCP1931	ATE	
1.6 EcoBoost	110	05/11 →				FCP1931	ATE	
1.6 EcoBoost	134	05/11 →				FCP1931	ATE	
1.6 Flexifuel	88	05/11 →				FCP1931	ATE	
1.6 LPG	88	02/12 →				FCP1931	ATE	
1.6 TDCi	70	05/11 →				FCP1931	ATE	
1.6 TDCi	85	05/11 →				FCP1931	ATE	
1.6 Ti	63	08/11 →				FCP1931	ATE	
1.6 Ti	77	05/11 →				FCP1931	ATE	
1.6 Ti	92	05/11 →				FCP1931	ATE	
2.0 TDCi	100	05/11 →				FCP1931	ATE	
2.0 TDCi	103	05/11 →				FCP1931	ATE	
2.0 TDCi	120	05/11 →				FCP1931	ATE	
2.0 TDCi	85	05/11 →				FCP1931	ATE	
Fusion								
1.4 i	59	08/02 →	FCP1394	ATE				
1.4 TDCi	50	08/02 →	FCP1394	ATE				
1.6 i	74	08/02 →	FCP1394	ATE				
Galaxy								
1.9 TDi	66, 81	06/95 → 04/00	FCP590	ATE				
1.9 TDi	66, 81	06/95 → 04/00				FCP541	LUCAS/TRW	
2.0	85	06/95 → 04/00	FCP590	ATE				
2.0	85	06/95 → 04/00				FCP541	LUCAS/TRW	
2.3 16V	107	06/95 → 04/00	FCP590	ATE				
2.3 16V	107	06/95 → 04/00				FCP541	LUCAS/TRW	
2.8	128	06/95 → 04/00	FCP590	ATE				
2.8	128	06/95 → 04/00				FCP541	LUCAS/TRW	
Galaxy III								
1.8 TDCi	74	05/06 →				FCP1917	LUCAS/TRW	Without EPB
1.8 TDCi	92	05/06 →				FCP1917	LUCAS/TRW	Without EPB
2.0	107	05/06 →				FCP1917	LUCAS/TRW	Without EPB
2.0 TDCi	103	05/06 →				FCP1917	LUCAS/TRW	Without EPB
2.0 TDCi	85	11/07 →				FCP1917	LUCAS/TRW	Without EPB
2.0 TDCi	96	05/06 →				FCP1917	LUCAS/TRW	Without EPB
2.2 TDCi	129	03/08 →				FCP1917	LUCAS/TRW	Without EPB
2.3	118	07/07 →				FCP1917	LUCAS/TRW	Without EPB
Granada								
1.6		01/77 → 06/79	FCP167	LUCAS/TRW				
1.6	55	07/79 → 07/81	FCP167	LUCAS/TRW				
1.6	55	08/81 → 08/82	FCP167	LUCAS/TRW				
1.6	55	09/82 → 12/85	FCP167	LUCAS/TRW				
1.7 Saloon	51	01/77 → 08/81	FCP167	LUCAS/TRW				
1.7 Saloon	51	09/81 → 04/85	FCP167	LUCAS/TRW				
1.8	66	05/85 → 07/87	FCP276	ATE				
1.8	66	05/85 → 07/87				FCP408	LUCAS/TRW	
1.9		03/78 → 08/82	FCP167	LUCAS/TRW				
2.0	66	01/75 → 04/79	FCP167	LUCAS/TRW				
2.0	74, 77	05/79 → 02/85	FCP167	LUCAS/TRW				
2.0	80	05/85 → 04/92	FCP276	ATE				
2.0	80	05/85 → 04/92				FCP408	LUCAS/TRW	
2.0	85	05/85 → 04/92	FCP276	ATE				
2.0	85	05/85 → 04/92				FCP408	LUCAS/TRW	
2.0	92	05/85 → 04/92	FCP276	ATE				
2.0	92	05/85 → 04/92				FCP408	LUCAS/TRW	
2.0 Ghia	85	05/92 → 10/94	FCP766	ATE				

For material availability see page 16-18 / Per la disponibilità materiali vedere a pagina 16-18



KW



...FORD			NOTE			NOTE		
...Granada								
2.0 Ghia	85	05/92 → 10/94	FCP167	LUCAS/TRW		FCP408	LUCAS/TRW	
2.1 D	46	09/79 → 06/82	FCP167	LUCAS/TRW				
2.3	79	05/79 → 02/85	FCP167	LUCAS/TRW				
2.3 SW Estate/Saloon	79	09/77 → 04/79	FCP167	LUCAS/TRW				
2.4	96	01/87 → 08/89	FCP276	ATE				
2.4	96	01/87 → 08/89				FCP408	LUCAS/TRW	
2.5 D/TD		08/86 → 01/92	FCP276	ATE				
2.5 D/TD		08/86 → 01/92				FCP408	LUCAS/TRW	
2.5 Saloon		01/76 → 08/77	FCP167	LUCAS/TRW				
2.8	110	05/85 → 01/87	FCP276	ATE				
2.8	110	05/85 → 01/87				FCP408	LUCAS/TRW	
2.9		01/87 → 03/92	FCP276	ATE				
2.9		01/87 → 03/92				FCP408	LUCAS/TRW	
2.9 24V	143	03/92 → 10/94	FCP276	ATE				
2.9 24V	143	03/92 → 10/94				FCP408	LUCAS/TRW	
2.9 Cosworth 24V		08/92 → 12/95	FCP767	ATE				
2.9 Cosworth 24V		08/92 → 12/95				FCP408	LUCAS/TRW	
2.9 Ghia/Saloon/SW Estate		05/92 → 10/94	FCP766	ATE				
2.9 Ghia/Saloon/SW Estate		05/92 → 10/94				FCP408	LUCAS/TRW	
3.0 Saloon	101	01/76 → 08/77	FCP167	LUCAS/TRW				
GRAND C-MAX								
1.6 EcoBoost	110	12/10 →				FCP1931	ATE	
1.6 EcoBoost	134	12/10 →				FCP1931	ATE	
1.6 TDCi	70	12/10 →				FCP1931	ATE	
1.6 TDCi	85	12/10 →				FCP1931	ATE	
1.6 Ti	77	12/10 →				FCP1931	ATE	
1.6 Ti	92	12/10 →				FCP1931	ATE	
2.0 TDCi	100	02/11 →				FCP1931	ATE	
2.0 TDCi	103	02/11 →				FCP1931	ATE	
2.0 TDCi	120	12/10 →				FCP1931	ATE	
2.0 TDCi	85	02/11 →				FCP1931	ATE	
Ka								
1.3	37, 44	10/96 → 01/00	FCP1082	ATE	Solid			
1.3	37, 44	10/96 → 01/00	FCP1081	ATE	Vented			
Kuga I								
2.0 TDCi	100	03/08 →				FCP1917	LUCAS/TRW	
2.0 TDCi	103	03/10 →				FCP1917	LUCAS/TRW	
2.0 TDCi 4x4	100	03/08 →				FCP1917	LUCAS/TRW	
2.0 TDCi 4x4	103	03/10 →				FCP1917	LUCAS/TRW	
2.0 TDCi 4x4	120	03/10 →				FCP1917	LUCAS/TRW	
2.5	147	03/09 →				FCP1917	LUCAS/TRW	
2.5 4x4	147	03/09 →				FCP1917	LUCAS/TRW	
Kuga II								
1.6 EcoBoost	110	03/13 →	FCP4416	ATE				
1.6 EcoBoost 4x4	134	03/13 →	FCP4416	ATE				
2.0 TDCi	103	03/13 →	FCP4416	ATE				
2.0 TDCi 4x4	103	03/13 →	FCP4416	ATE				
2.0 TDCi 4x4	120	03/13 →	FCP4416	ATE				
Mondeo								
1.6 16V	66	03/93 → 12/00	FCP766	ATE				
1.8 16V	85	03/93 → 12/00	FCP766	ATE				
1.8 TD		03/93 → 12/00	FCP766	ATE				
2.0 16V	100	03/93 → 12/00	FCP766	ATE				
2.0 16V	100	08/96 → 12/00	FCP767	ATE	15" Wheel			
2.0 i Si, Ghia, 4x4 16V	100	03/93 → 12/00	FCP766	ATE	14" Wheel			
2.0 i Si, Ghia, 4x4 16V	100	03/93 → 12/00	FCP767	ATE	15" Wheel			
2.5 24V	125	10/94 → 12/00	FCP767	ATE				
Mondeo II								
1.6 i 16V	66	08/96 → 12/00	FCP766	ATE				
1.8 i 16V	85	08/96 → 12/00	FCP766	ATE				
1.8 TD	66	08/96 → 12/00	FCP766	ATE				
2.0 i 16V	100	08/96 → 12/00	FCP766	ATE				
2.0 i 16V	100	08/96 → 12/00	FCP767	ATE				
2.5 i 24V	125	10/94 → 12/00	FCP767	ATE				

FORD

For material availability see page 16-18 / Per la disponibilità materiali vedere a pagina 16-18



KW



...FORD

Mondeo IV (BA7)

1.6 Ti	81	03/07	→
1.6 Ti	92	03/07	→
1.8 TDCi	74	03/07	→
2.0	107	03/07	→
2.0 TDCi	103	03/07	→
2.0 TDCi	85	11/07	→
2.0 TDCi	96	03/07	→
2.2 TDCi	129	03/08	→
2.3	118	07/07	→
2.5	162	03/07	→

Mondeo IV Saloon (BA7)

1.6 Ti	81	03/07	→
1.6 Ti	92	03/07	→
2.0 TDCi	103	03/07	→
2.0 TDCi	96	03/07	→

Mondeo SW IV

1.8 TDCi	74	03/07	→
2.0	107	03/07	→
2.0 TDCi	85	11/07	→
2.2 TDCi	129	03/08	→
2.3	118	07/07	→
2.5	162	03/07	→

Mustang

4.0 V6	157	12/04	→
4.0 V6	157	12/04	→
5.0		01/11	→ 12/11
5.0		01/11	→ 12/11
5.0L Performance		01/11	→ 12/11
Bullit 4.6		01/08	→ 12/09
Bullit 4.6		01/08	→ 12/09
GT 4.6		01/05	→ 12/10
GT 4.6		01/05	→ 12/10
GT Performance Pack 5.0L Ti-VCT V8	324	01/15	→
GT350 Hummingbird		01/16	→
Shelby GT 4.6		01/07	→ 12/08
Shelby GT 4.6		01/07	→ 12/08
Shelby GT500		01/07	→ 12/14
Shelby GT500		01/07	→ 12/14
V6 3.7		01/11	→
V6 3.7		01/11	→

Orion

1.3	44	02/86	→ 10/90
1.3	44	10/90	→ 12/92
1.3	44	01/93	→ 12/94
1.3	51	09/83	→ 12/85
1.4	55	02/86	→ 10/90
1.4 Auto/Manual	51	10/90	→ 12/94
1.4 Auto/Manual	52	10/90	→ 12/94
1.4 Auto/Manual	54	10/90	→ 12/94
1.6	59	09/83	→ 10/90
1.6	65	09/83	→ 10/90
1.6	66	09/83	→ 10/90
1.6 Auto/Manual	66, 77	10/90	→ 12/94
1.6 D	40	09/83	→ 10/90
1.6 D	40	01/86	→ 10/90
1.6 D Ghia	40	10/83	→ 01/86
1.6 Ghia	59, 77	10/83	→ 10/90
1.6 Ghia	66, 77	02/86	→ 10/90
1.8	44	09/88	→ 10/90
1.8 D	44, 55	10/90	→ 12/94
1.8 i 16V	77	10/90	→ 12/94
1.8 i Ghia Si 16V	96	10/90	→ 12/94
1.8 i Ghia Si 16V	96	10/90	→ 12/94

P100

1.8 TD	55	05/89	→ 12/94
2.0	74	01/88	→ 12/94

NOTE

NOTE

FCP1917	LUCAS/TRW	Without EPB
FCP1917	LUCAS/TRW	Without EPB
FCP1917	LUCAS/TRW	Without EPB
FCP1917	LUCAS/TRW	Without EPB
FCP1917	LUCAS/TRW	Without EPB
FCP1917	LUCAS/TRW	Without EPB
FCP1917	LUCAS/TRW	Without EPB
FCP1917	LUCAS/TRW	Without EPB
FCP1917	LUCAS/TRW	Without EPB
FCP1917	LUCAS/TRW	Without EPB

FCP1917	LUCAS/TRW	Without EPB
FCP1917	LUCAS/TRW	Without EPB
FCP1917	LUCAS/TRW	Without EPB
FCP1917	LUCAS/TRW	Without EPB

FCP1917	LUCAS/TRW	Without EPB
FCP1917	LUCAS/TRW	Without EPB
FCP1917	LUCAS/TRW	Without EPB
FCP1917	LUCAS/TRW	Without EPB
FCP1917	LUCAS/TRW	Without EPB
FCP1917	LUCAS/TRW	Without EPB

FRP3129		
FRP3130	LUCAS/TRW	
FRP3129		
FRP3130	LUCAS/TRW	
FRP3130	LUCAS/TRW	
FRP3129		
FRP3130	LUCAS/TRW	
FCP4711	BREMBO	Performance pack for 15inch(380mm) discs
FCP4835	BREMBO	
FRP3129		
FRP3130	LUCAS/TRW	
FCP1334	BREMBO	
FRP3130	LUCAS/TRW	
FRP3129		
FRP3130	LUCAS/TRW	

FCP206	ATE	
FCP617	BENDIX	
FCP617	BENDIX	
FCP206	ATE	
FCP206	ATE	
FCP617	BENDIX	
FCP617	BENDIX	
FCP617	BENDIX	
FCP206	ATE	
FCP206	ATE	
FCP206	ATE	
FCP617	BENDIX	
FCP206	ATE	
FCP206	ATE	
FCP206	ATE	
FCP617	BENDIX	
FCP617	BENDIX	
FCP617	BENDIX	
FCP276	ATE	

FCP206	ATE	
FCP206	ATE	

For material availability see page 16-18 / Per la disponibilità materiali vedere a pagina 16-18



KW



...FORD

Puma

					NOTE			NOTE
1.4 16V	66	07/97	→ 02/00	FCP1081	ATE			
1.4 i 16V	66	03/00	→ 10/00	FCP1394	ATE			
1.6 i 16V	76	08/00	→	FCP1394	ATE			
1.7 16V	92	07/97	→ 02/00	FCP1081	ATE			
1.7 i 16V	92	03/00	→	FCP1394	ATE			

S-MAX (WA6)

1.8 TDCi	92	05/06	→				FCP1917	LUCAS/TRW	Without EPB
2.0	107	05/06	→				FCP1917	LUCAS/TRW	Without EPB
2.0 TDCi	103	05/06	→				FCP1917	LUCAS/TRW	Without EPB
2.0 TDCi	85	11/07	→				FCP1917	LUCAS/TRW	Without EPB
2.0 TDCi	96	05/06	→				FCP1917	LUCAS/TRW	Without EPB
2.2 TDCi	129	03/08	→				FCP1917	LUCAS/TRW	Without EPB
2.3	118	07/07	→				FCP1917	LUCAS/TRW	Without EPB
2.5 ST	162	05/06	→				FCP1917	LUCAS/TRW	Without EPB

Scorpio

1.8 CL, GL	66	01/85	→ 12/92	FCP276	ATE				
1.8 CL, GL	66	01/85	→ 12/92				FCP408	LUCAS/TRW	
2.0	85	10/94	→ 08/97	FCP766	ATE				
2.0	85	10/94	→ 08/97				FCP408	LUCAS/TRW	
2.0 CL, GL	77	12/86	→ 12/92	FCP276	ATE				
2.0 CL, GL, Ghia, Clipper	77	01/85	→ 12/92	FCP276	ATE				
2.0 CL, GL, Ghia, Clipper	77	01/85	→ 12/92				FCP408	LUCAS/TRW	
2.0 Ghia, Clipper	77	12/86	→ 12/92	FCP276	ATE				
2.0 Ghia, Clipper	77	12/86	→ 12/92				FCP408	LUCAS/TRW	
2.3 16V	107	10/94	→ 08/98	FCP766	ATE				
2.3 16V	107	10/94	→ 08/98				FCP408	LUCAS/TRW	
2.4	92, 96	01/85	→ 12/94	FCP276	ATE				
2.4	92, 96	01/85	→ 12/94				FCP408	LUCAS/TRW	
2.4 i	92, 96	01/87	→ 12/94	FCP276	ATE				
2.4 i	92, 96	01/87	→ 12/94				FCP408	LUCAS/TRW	
2.5 D, TD Ghia, Clipper		01/85	→ 12/92	FCP276	ATE				
2.5 D, TD Ghia, Clipper		01/85	→ 12/92				FCP408	LUCAS/TRW	
2.5 TD	85	10/94	→ 06/96	FCP766	ATE				
2.5 TD	85	10/94	→ 06/96				FCP408	LUCAS/TRW	
2.8 GL, Ghia	110	01/85	→ 12/92	FCP276	ATE				
2.8 GL, Ghia	110	01/85	→ 12/92				FCP408	LUCAS/TRW	
2.9	107, 110	01/85	→ 06/96	FCP276	ATE				
2.9	107, 110	01/85	→ 06/96				FCP408	LUCAS/TRW	
2.9 24V	152	10/94	→ 08/98	FCP767	ATE				
2.9 24V	152	10/94	→ 08/98				FCP408	LUCAS/TRW	
2.9 i	107, 110	01/87	→ 09/94	FCP276	ATE				
2.9 i	107, 110	01/87	→ 09/94				FCP408	LUCAS/TRW	

Sierra

1.3		01/86	→ 12/92	FCP276	ATE				
1.3		01/86	→ 12/92				FCP408	LUCAS/TRW	
1.3	44	10/82	→ 10/86	FCP206	ATE				
1.6	51, 55	10/82	→ 02/87	FCP206	ATE				
1.6	53	03/87	→ 02/93	FCP276	ATE	ABS			
1.6	53	03/87	→ 02/93	FCP206	ATE				
1.6	53	03/87	→ 02/93				FCP408	LUCAS/TRW	ABS
1.6	55	03/87	→ 02/93	FCP276	ATE	ABS			
1.6	55	03/87	→ 02/93	FCP206	ATE				
1.6	55	03/87	→ 02/93				FCP408	LUCAS/TRW	ABS
1.6	59	03/87	→ 02/93	FCP276	ATE	ABS			
1.6	59	03/87	→ 02/93	FCP206	ATE				
1.6	59	03/87	→ 02/93				FCP408	LUCAS/TRW	ABS
1.6 SW Estate	51	01/82	→ 12/92	FCP206	ATE				
1.6 SW Estate	51	01/82	→ 12/92	FCP276	ATE	ABS			
1.6 SW Estate	51	01/82	→ 12/92				FCP408	LUCAS/TRW	ABS
1.6 SW Estate	55	01/82	→ 12/92	FCP206	ATE				
1.6 SW Estate	55	01/82	→ 12/92	FCP276	ATE	ABS			
1.6 SW Estate	55	01/82	→ 12/92				FCP408	LUCAS/TRW	ABS
1.6 SW Estate	59	01/82	→ 12/92	FCP206	ATE				
1.6 SW Estate	59	01/82	→ 12/92	FCP276	ATE	ABS			
1.6 SW Estate	59	01/82	→ 12/92				FCP408	LUCAS/TRW	ABS
1.8	64, 66	02/87	→ 02/93	FCP206	ATE				
1.8	64, 66	02/87	→ 02/93	FCP276	ATE	ABS			
1.8	64, 66	02/87	→ 02/93				FCP408	LUCAS/TRW	ABS
1.8	66	10/84	→ 02/87	FCP206	ATE				
1.8 SW Estate	64, 66	01/82	→ 12/86	FCP276	ATE	ABS			
1.8 SW Estate	64, 66	01/82	→ 12/86				FCP408	LUCAS/TRW	ABS
1.8 SW Estate	64, 66	01/87	→ 02/93	FCP206	ATE				
1.8 SW Estate	64, 66	01/87	→ 02/93				FCP408	LUCAS/TRW	ABS
1.8 TD		01/90	→ 12/92	FCP206	ATE				

For material availability see page 16-18 / Per la disponibilità materiali vedere a pagina 16-18



KW



...FORD

...Sierra

					NOTE			NOTE
2.0	77	10/82 → 02/87	FCP206	ATE				
2.0	77	10/82 → 02/87	FCP276	ATE	ABS			
2.0	77	03/87 → 02/93	FCP206	ATE				
2.0	77	03/87 → 02/93	FCP276	ATE	ABS			
2.0	77	03/87 → 02/93				FCP408	LUCAS/TRW	ABS
2.0 i XR4, 4x4		02/90 → 02/93	FCP276	ATE				
2.0 i XR4, 4x4		02/90 → 02/93				FCP408	LUCAS/TRW	
2.0 i XR4i		12/82 → 03/88	FCP276	ATE				
2.0 SW Estate		01/82 → 12/86	FCP206	ATE				
2.0 SW Estate		01/82 → 12/86	FCP276	ATE	ABS			
2.0 SW Estate		01/82 → 12/86				FCP408	LUCAS/TRW	ABS
2.0 SW Estate		01/87 → 02/93	FCP206	ATE				
2.0 SW Estate		01/87 → 02/93	FCP276	ATE	ABS			
2.0 SW Estate		01/87 → 02/93				FCP408	LUCAS/TRW	ABS
2.3 D	49	10/82 → 02/87	FCP206	ATE				
2.3 D	49	02/87 → 02/90	FCP206	ATE				
2.3 D	49	02/87 → 02/90	FCP276	ATE	ABS			
2.3 D	49	02/87 → 02/90				FCP408	LUCAS/TRW	ABS
2.3 D SW Estate	49	01/82 → 12/90	FCP206	ATE				
2.3 D SW Estate	49	01/82 → 12/90	FCP276	ATE	ABS			
2.3 D SW Estate	49	01/82 → 12/90				FCP408	LUCAS/TRW	ABS
2.3 D SW Estate	49	01/91 → 02/93	FCP206	ATE				
2.3 D SW Estate	49	01/91 → 02/93	FCP276	ATE	ABS			
2.3 D SW Estate	49	01/91 → 02/93				FCP408	LUCAS/TRW	ABS
2.3 SW Estate	84	01/82 → 12/87	FCP206	ATE				
2.3 SW Estate	84	01/82 → 12/87	FCP276	ATE	ABS			
2.3 SW Estate	84	01/82 → 12/87				FCP408	LUCAS/TRW	ABS
2.3 SW Estate	84	01/87 → 02/93	FCP206	ATE				
2.3 SW Estate	84	01/87 → 02/93	FCP276	ATE	ABS			
2.3 SW Estate	84	01/87 → 02/93				FCP408	LUCAS/TRW	ABS
2.8 4x4	110	06/85 → 01/93	FCP276	ATE				
2.8 4x4	110	06/85 → 01/93				FCP408	LUCAS/TRW	
2.8 4x4 SW Estate	110	01/82 → 02/93	FCP276	ATE				
2.8 4x4 SW Estate	110	01/82 → 02/93				FCP408	LUCAS/TRW	
2.8 XR4i		01/83 → 12/85	FCP276	ATE				
2.9	107, 110	05/89 → 12/95	FCP276	ATE				
2.9	107, 110	05/89 → 12/95				FCP408	LUCAS/TRW	
2.9 V6 4x4 SW Estate	110	01/82 → 02/93	FCP276	ATE				
2.9 V6 4x4 SW Estate	110	01/82 → 02/93				FCP408	LUCAS/TRW	

Sierra Cosworth

2.0 4x4 16V	162	01/89 → 02/93	FCP685	ATE				
2.0 4x4 16V	162	01/89 → 02/93				FCP408	LUCAS/TRW	
2.0 RS 16V	150, 162	07/86 → 02/93	FCP399		LUCAS/TRW			
2.0 RS 16V	150, 162	07/86 → 02/93				FCP408	LUCAS/TRW	

Sierra Sapphire

1.6	55, 59	03/87 → 02/95	FCP206	ATE				
1.6	55, 59	03/87 → 02/95	FCP276	ATE	ABS			
1.6	55, 59	03/87 → 02/95				FCP408	LUCAS/TRW	ABS
1.8	64, 66	03/87 → 02/95	FCP206	ATE				
1.8	64, 66	03/87 → 02/95	FCP276	ATE	ABS			
1.8	64, 66	03/87 → 02/95				FCP408	LUCAS/TRW	ABS
2.0	77	03/87 → 02/93	FCP276	ATE	ABS			
2.0	77	03/87 → 02/93	FCP206	ATE				
2.0	77	03/87 → 02/93				FCP408	LUCAS/TRW	ABS
2.0	85	03/87 → 02/93	FCP276	ATE	ABS			
2.0	85	03/87 → 02/93	FCP206	ATE				
2.0	85	03/87 → 02/93				FCP408	LUCAS/TRW	ABS
2.0	92	03/87 → 02/93	FCP276	ATE	ABS			
2.0	92	03/87 → 02/93	FCP206	ATE				
2.0	92	03/87 → 02/93				FCP408	LUCAS/TRW	ABS
2.0 RS Cosworth 2WD		02/88 → 02/93	FCP399		LUCAS/TRW			
2.0 RS Cosworth 2WD		02/88 → 02/93				FCP408	LUCAS/TRW	
2.0 RS Cosworth 4x4		02/88 → 02/93	FCP685	ATE				
2.0 RS Cosworth 4x4		02/88 → 02/93				FCP408	LUCAS/TRW	
2.3 D	49	01/87 → 12/90	FCP206	ATE				
2.3 D	49	01/87 → 12/90	FCP276	ATE	ABS			
2.3 D	49	01/87 → 12/90				FCP408	LUCAS/TRW	
2.3 D	49	01/91 → 02/93	FCP206	ATE				
2.3 D	49	01/91 → 02/93	FCP276	ATE	ABS			
2.3 D	49	01/91 → 02/93				FCP408	LUCAS/TRW	

For material availability see page 16-18 / Per la disponibilità materiali vedere a pagina 16-18



KW

**...FORD****Street Ka**

1.6 i 70 02/03 →

FCP1394 ATE

NOTE

NOTE

Taurus

1.3	41, 44	01/70 → 12/92	FCP167	LUCAS/TRW
1.3 i		01/79 → 12/82	FCP167	LUCAS/TRW
1.3 i		01/83 → 12/92	FCP167	LUCAS/TRW
1.3 i	41, 44	01/74 → 12/79	FCP167	LUCAS/TRW
1.6	53, 66	01/70 → 12/92	FCP167	LUCAS/TRW
1.6 i	53, 66	01/75 → 12/79	FCP167	LUCAS/TRW
1.6 i	53, 66	01/80 → 12/82	FCP167	LUCAS/TRW
1.6 i	53, 66	01/83 → 12/92	FCP167	LUCAS/TRW
2.0 Sedan/SW Estate	66	01/76 → 12/82	FCP167	LUCAS/TRW
2.3	79	07/79 → 07/82	FCP167	LUCAS/TRW

FORD USA**Focus I**

01/98 → 12/01 FCP1318 KELGATE

Mustang , Cobra

01/94 → 12/00 FCP1224 KELGATE

Formula Renault**2.0**

01/13 → 12/13 FRP3092 PFC

01/13 → 12/13

FRP3092 PFC

FSO**125**

1.3 01/76 → 06/90 FCP29 BENDIX

Polonez

1.5 11/78 → FCP29 BENDIX

1.6 11/78 → FCP29 BENDIX

Prima

1.5 55 09/88 → 09/95 FCP29 BENDIX

1.6 60 09/94 → FCP29 BENDIX

1.9 51 09/91 → FCP29 BENDIX

GEO**Prism**

01/89 → 12/92 FCP308 KELGATE

GINETTA**G 40**

2.0 168 01/98 → FCP399 ATE

2.0 168 01/98 →

FCP408

G 40R

2.0 12/10 → FCP399 ATE

2.0 12/10 →

FCP399 ATE

G4

01/61 → 12/69 FCP809 LUCAS/TRW

For material availability see page 16-18 / Per la disponibilità materiali vedere a pagina 16-18



KW



GLAS

04 all models

01/63 → 12/69
01/63 → 12/69

FCP3 ATE

NOTE

NOTE

2600 GT/3000 GT

01/65 → 12/69
01/65 → 12/69

FCP11 ATE

FCP3 ATE

HOLDEN

COMBO Box (XC)

1.6 i 62 09/02 → 04/05

FCP1640 ATE

Commodore

VX,VU,VY,VZ 01/00 →

FCP1553 KELGATE

HONDA

Accord

1.8 i CE7 02/96 → 10/98
1.8 i CE7 02/96 → 10/98
1.8 i CE7 02/96 → 10/98
2.0 CB 16V 66 09/89 → 12/93
2.0 CB 16V 66 09/89 → 12/93
2.0 CB 16V 81 09/89 → 12/93
2.0 CB 16V 81 09/89 → 12/93
2.0 CB 16V 98 09/89 → 12/93
2.0 CB 16V 98 09/89 → 12/93
2.2 16V 09/89 → 12/91
2.2 16V 09/89 → 12/91
2.2 4 wheel drive 16V 01/91 →
2.2 4 wheel drive 16V 01/91 →
2.2 i CE9 VTEC 16V 110 02/96 → 10/98
2.2 i CE9 VTEC 16V 110 02/96 → 10/98
2.3 16V 05/93 → 02/96
2.3 16V 05/93 → 02/96
2.3 16V 05/93 → 02/96
2.3 16V 05/96 →
2.3 16V 05/96 →
2.3 i CC7 16V 116 01/93 → 02/96
2.3 i CC7 16V 116 01/93 → 02/96

FCP904 AKEBONO
FCP905 AKEBONO
FCP761 AKEBONO
FCP761 AKEBONO
FCP761 AKEBONO
FCP761 AKEBONO
FCP761 AKEBONO
FCP598 AKEBONO
FCP598 AKEBONO
FCP905 AKEBONO
FCP905 AKEBONO
FCP904 AKEBONO
FCP905 AKEBONO
FCP761 AKEBONO
FCP761 AKEBONO
FCP905 AKEBONO
FCP905 AKEBONO

14" wheel
15" wheel

FCP956 NISSIN
FCP956 NISSIN
FCP956 NISSIN
FCP956 NISSIN
FCP472 AKEBONO
FCP956 NISSIN
FCP956 NISSIN
FCP956 NISSIN
FCP956 NISSIN
FCP956 NISSIN
FCP956 NISSIN
FCP956 NISSIN

Accord Aerodeck

2.0 CC 16V 98 01/91 → 12/92
2.0 CC 16V 98 01/91 → 12/92
2.0 CC 16V 98 01/92 → 12/94
2.0 CC 16V 98 01/92 → 12/94
2.0 CC 16V 98 01/95 →
2.0 CC 16V 98 01/95 →
2.0 i CE2/CE1 16V 136 01/94 → 12/97
2.0 i CE2/CE1 16V 136 01/94 → 12/97
2.2 CC 16V 108, 110 01/91 → 12/92
2.2 CC 16V 108, 110 01/91 → 12/92
2.2 CC 16V 108, 110 01/92 → 12/94
2.2 CC 16V 108, 110 01/92 → 12/94
2.2 CC 16V 108, 110 01/95 →
2.2 CC 16V 108, 110 01/95 →
2.2 i CE2/CE1 16V 150 01/94 → 12/97
2.2 i CE2/CE1 16V 150 01/94 → 12/97
2.2 i CB8/9 16V 01/91 → 12/94

FCP905 AKEBONO
FCP904 AKEBONO
FCP761 AKEBONO
FCP905 AKEBONO
FCP905 AKEBONO
FCP905 AKEBONO
FCP905 AKEBONO
FCP905 AKEBONO
FCP904 AKEBONO
FCP761 AKEBONO
FCP905 AKEBONO
FCP905 AKEBONO
FCP905 AKEBONO
FCP905 AKEBONO
FCP905 AKEBONO
FCP905 AKEBONO
FCP905 AKEBONO
FCP905 AKEBONO

15" wheel
14" wheel
14" wheel
14" wheel
14" wheel

FCP956 NISSIN
FCP956 NISSIN
FCP956 NISSIN
FCP956 NISSIN
FCP956 NISSIN
FCP956 NISSIN
FCP956 NISSIN
FCP956 NISSIN
FCP956 NISSIN
FCP956 NISSIN
FCP956 NISSIN
FCP956 NISSIN
FCP956 NISSIN

Accord Coupe

2.0 16V 98 01/92 → 12/94
2.0 16V 98 01/92 → 12/94
2.0 16V 98 01/95 →
2.0 16V 98 01/95 →
2.0 i CG4 16V 147 02/98 → 12/02
2.0 i CG4 16V 147 02/98 → 12/02
2.2 110 09/93 → 12/97
2.2 110 01/98 →
3.0 i CG2 V6 200 02/98 → 12/02
3.0 i CG2 V6 200 02/98 → 12/02

FCP904 AKEBONO
FCP761 AKEBONO
FCP905 AKEBONO
FCP905 AKEBONO
FCP904 AKEBONO
FCP761 AKEBONO
FCP905 AKEBONO

FCP956 NISSIN
FCP956 NISSIN
FCP956 NISSIN
FCP956 NISSIN
FCP956 NISSIN
FCP956 NISSIN

For material availability see page 16-18 / Per la disponibilità materiali vedere a pagina 16-18

1100

FERODO

RACING

Updated on 17th Aug 2018

GLAS



KW



...HONDA

ACCORD III (CA)

Model	Year	From	To	FCP	Brand
2.0 EX (CA5)	75	11/85	→ 12/89	FCP748	AKEBONO
2.0 EX (CA5)	75	11/85	→ 12/89		
2.0 EX (CA5)	76	11/85	→ 12/89	FCP748	AKEBONO
2.0 EX (CA5)	76	11/85	→ 12/89		
2.0 EX (CA5)	78	11/85	→ 05/89	FCP748	AKEBONO
2.0 EX (CA5)	78	11/85	→ 05/89		
2.0 EXi (CA5)	85	01/86	→ 12/89	FCP748	AKEBONO
2.0 EXi (CA5)	85	01/86	→ 12/89		
2.0 i 16V (CA5)	101	01/87	→ 12/87	FCP748	AKEBONO
2.0 i 16V (CA5)	101	01/87	→ 12/87		

ACCORD III Aerodeck (CA)

Model	Year	From	To	FCP	Brand
2.0	101	01/86	→ 12/86	FCP748	AKEBONO
2.0	101	01/86	→ 12/86		
2.0 EX	75	10/87	→ 12/89		
2.0 EX (CA5)	76	10/87	→ 12/89	FCP748	AKEBONO
2.0 EX (CA5)	76	10/87	→ 12/89		
2.0 EX (CA5)	78	11/85	→ 05/89	FCP748	AKEBONO
2.0 EX (CA5)	78	11/85	→ 05/89		
2.0 EXi (CA5)	85	10/87	→ 12/89		

ACCORD V (CC, CD)

Model	Year	From	To	FCP	Brand	NOTE
2.0 i	85	03/93	→ 01/96	FCP904	AKEBONO	14" wheel
2.0 i	85	03/93	→ 01/96	FCP905	AKEBONO	15" wheel
2.0 i	85	03/93	→ 01/96			FCP956 NISSIN
2.0 i S	96	03/93	→ 01/96	FCP904	AKEBONO	14" wheel
2.0 i S	96	03/93	→ 01/96	FCP905	AKEBONO	15" wheel
2.0 i S	96	03/93	→ 01/96			FCP956 NISSIN
2.3 i SR	116	03/93	→ 01/96	FCP905	AKEBONO	15" wheel
2.3 i SR	116	03/93	→ 01/96			FCP956 NISSIN

ACCORD V (CE, CF_)

Model	Year	From	To	FCP	Brand	NOTE
2.0 i LS (CE8)	96	02/96	→ 10/98	FCP904	AKEBONO	14" wheel
2.0 i LS (CE8)	96	02/96	→ 10/98	FCP905	AKEBONO	15" wheel
2.0 i LS (CE8)	96	02/96	→ 10/98			FCP956 NISSIN

Accord VI

Model	Year	From	To	FCP	Brand	NOTE
2.2 Type R	156	01/99	→ 12/02	FCP905	AKEBONO	
2.2 Type R	156	01/99	→ 12/02			FCP541 LUCAS/TRW

CITY Saloon (GM)

Model	Year	From	To	FCP	Brand	NOTE
1.4 i-V TEC	73	09/08	→	FCP4404	AKEBONO	

Civic

Model	Year	From	To	FCP	Brand	NOTE
1.2	77	01/73	→ 12/75	FCP39	SUMITOMO	
1.4 i EJ9 16V	66	01/98	→ 02/01	FCP776	AKEBONO	
1.5 i 16V	84	10/95	→ 02/01	FCP776	AKEBONO	
1.5 i 16V	84	10/95	→ 02/01			FCP472 AKEBONO
1.6 ED4-ED7 16V	81, 96	01/87	→ 10/91	FCP598	AKEBONO	
1.6 ED4-ED7 16V	81, 96	01/87	→ 10/91			FCP472 AKEBONO
1.6 EE9 16V	81, 96	01/90	→ 10/91	FCP613	AKEBONO	
1.6 EE9 16V	81, 96	01/90	→ 10/91			FCP472 AKEBONO
1.6 EK1, EK4 Vti 16V		10/95	→ 02/01	FCP776	AKEBONO	
1.6 EK1, EK4 Vti 16V		10/95	→ 02/01			FCP472 AKEBONO
1.6 i 16V	83	09/94	→ 01/97	FCP613	LUCAS/TRW	
1.6 i MB1 VTEC 16V	93	01/95	→ 12/97	FCP613	LUCAS/TRW	
1.6 i MB1 VTEC 16V	93	01/95	→ 12/97			FCP472 AKEBONO
1.8 MB6 16V	124	01/97	→ 02/01	FCP905	AKEBONO	
1.8 MB6 16V	124	01/97	→ 02/01			FCP472 AKEBONO
2.0 TDi MB7	63	01/97	→ 02/01	FCP613	LUCAS/TRW	
2.0 TDi MB7	63	01/97	→ 02/01			FCP472 AKEBONO
Si with ABS		01/94	→ 12/95	FCP1436	AKEBONO	

Civic Aerodeck

Model	Year	From	To	FCP	Brand	NOTE
1.6 16V	85	02/98	→ 02/01	FCP613	LUCAS/TRW	
1.6 16V	85	02/98	→ 02/01			FCP472 AKEBONO
1.8 16V	124	02/98	→ 02/01	FCP613	LUCAS/TRW	
1.8 16V	124	02/98	→ 02/01			FCP472 AKEBONO

Civic Coupe

Model	Year	From	To	FCP	Brand	NOTE
1.5 i EJ2 16V	69, 74	01/94	→ 11/95	FCP777	AKEBONO	
1.5 i EJ2 16V	69, 74	01/94	→ 11/95	FCP777	AKEBONO	
1.6 i EJ1 16V	92	01/94	→ 11/95	FCP776	AKEBONO	
1.6 i EJ6 16V		03/96	→ 03/00	FCP777	AKEBONO	
1.6 i EJ8 VTEC 16V		03/96	→ 03/00	FCP776	AKEBONO	
1.6 i EJ1 16V	92	01/94	→ 11/95	FCP776	AKEBONO	

For material availability see page 16-18 / Per la disponibilità materiali vedere a pagina 16-18



KW



...HONDA

...Civic Coupe

1.6 i VTEC VTi 16V	01/92 →	FCP776	AKEBONO
1.6 i VTEC VTi 16V	01/92 →		

Civic CRX

1.6 EE VTEC 16V	110 01/89 → 12/91	FCP613	AKEBONO
1.6 i EG VTEC VTi 16V	92, 118 01/92 → 12/93	FCP776	AKEBONO
1.6 i EH VTEC Esi 16V	92, 118 01/92 → 12/93	FCP777	AKEBONO

Civic I

1.5 i	52 01/76 → 12/77	FCP39	SUMITOMO
-------	------------------	-------	----------

Civic IV

1.3 EG 16V	55 11/91 → 12/95	FCP776	AKEBONO
1.4 16V	11/91 → 12/94	FCP776	AKEBONO
1.4 16V	11/91 → 12/94	FCP472	AKEBONO
1.4 16V	11/91 → 12/94	FCP777	AKEBONO
1.4 i EJ9 16V	66 01/96 → 01/98	FCP777	AKEBONO
1.4 i MA8 16V	09/94 → 01/97	FCP613	LUCAS/TRW
1.4 i MB2 16V	01/97 → 12/98	FCP613	LUCAS/TRW
1.4 MA 16V	55, 66 01/94 → 12/96	FCP613	LUCAS/TRW
1.5 16V	61 11/91 → 12/92	FCP777	AKEBONO
1.5 16V	61 11/91 → 12/92	FCP776	AKEBONO
1.5 16V	61 11/91 → 12/92		
1.5 16V	66 11/91 → 12/95	FCP777	AKEBONO
1.5 16V	66 11/91 → 12/95	FCP776	AKEBONO
1.5 16V	66 11/91 → 12/95		
1.5 16V	66 11/91 → 12/95	FCP472	AKEBONO
1.5 i 16V	66 12/94 → 12/95	FCP777	AKEBONO
1.5 i EG4 16V	01/92 → 12/95	FCP777	AKEBONO
1.5 i MA9 VTEC-E 16V	09/94 → 01/97	FCP613	LUCAS/TRW

Civic Shuttle

1.5 EE1/2 16V	66 01/88 → 12/91	FCP598	AKEBONO
1.6 EE 16V	80, 81 04/88 → 12/92	FCP598	AKEBONO

Civic V

1.3 i EG 16V	55 01/94 → 02/01	FCP776	AKEBONO
1.4 i MB2 16V	01/99 → 02/01	FCP613	LUCAS/TRW
1.5 16V	84 01/96 →	FCP777	AKEBONO
1.5 i 16V	66 12/94 → 12/95	FCP776	AKEBONO
1.5 i 16V	66 12/94 → 12/95		
1.5 i 16V	84 10/95 → 02/01	FCP777	AKEBONO
1.5 i EK3 16V	11/95 → 02/01	FCP776	AKEBONO
1.5 i MB3 16V	01/97 → 02/01	FCP613	LUCAS/TRW

CIVIC V Coupe (EJ)

1.6 i Vtec	118 01/94 → 11/95	FCP776	AKEBONO
1.6 i Vtec	118 01/94 → 11/95		
1.6 i Vtec (EJ1)	92 01/94 → 03/96	FCP776	AKEBONO
1.6 i Vtec (EJ1)	92 01/94 → 03/96		

Civic V Fastback

1.8 VTi	01/97 →	FCP905	AKEBONO
---------	---------	--------	---------

CIVIC V Hatchback (EG)

1.6 16V Vtec (EG5)	92 10/91 → 11/95	FCP777	AKEBONO
1.6 16V Vtec (EG5)	92 10/91 → 11/95	FCP776	AKEBONO
1.6 16V Vtec (EG5)	92 10/91 → 11/95		

CIVIC V Saloon (EG, EH)

1.6 16V Vtec (EH9)	92 10/91 → 11/95	FCP777	AKEBONO
1.6 16V Vtec (EH9)	92 10/91 → 11/95	FCP776	AKEBONO
1.6 16V Vtec (EH9)	92 10/91 → 11/95		

Civic VII

1.7 CTDi	74 01/02 → 09/05	FCP1444	SUMITOMO
1.7 CTDi	74 01/02 → 09/05		
2.0 i Sport	118 01/04 → 09/05	FCP1444	SUMITOMO
2.0 i Sport	118 01/04 → 09/05		
2.0 Type R	147 09/01 → 09/05	FCP1444	SUMITOMO
2.0 Type R	147 09/01 → 09/05		

NOTE

NOTE

HONDA

For material availability see page 16-18 / Per la disponibilità materiali vedere a pagina 16-18



KW

**...HONDA****Civic VIII**

Model	Year	Month	Direction	FCP Part	Supplier
1.4	61	01/06	→	FCP1859	SUMITOMO
1.4	61	01/06	→	FCP1859	SUMITOMO
1.8	103	01/06	→	FCP1859	SUMITOMO
1.8	103	01/06	→	FCP1859	SUMITOMO
2.0	114	01/06	→	FCP1859	SUMITOMO
2.0	114	01/06	→	FCP1859	SUMITOMO
2.0 Type R	148	09/06	→	FCP1444	SUMITOMO
2.0 Type R	148	09/06	→	FCP1862	LUCAS/TRW
2.0 Type R	148	01/07	→	FRP3105	
2.0 Type R	148	01/07	→	FCP1862	LUCAS/TRW
2.2 CTDi	103	01/06	→	FCP1859	SUMITOMO
2.2 CTDi	103	01/06	→	FCP1862	LUCAS/TRW

NOTE

NOTE

CIVIC-IX (FK)

1.4 i-VTEC	73	01/12	→	FCP1862	LUCAS/TRW
1.8 i-VTEC	104	01/12	→	FCP1862	LUCAS/TRW
2.0 i-VTEC Type R (FK2)	228	08/15	→	FRP3067	BREMBO
2.0 i-VTEC Type R (FK2)	228	08/15	→	FCP1676	TEVES

CIVIC-X Hatchback (FC_,FK)

2.0 Type-R (FK8)	235	06/17	→	FRP3067	BREMBO
2.0 Type-R (FK8)	235	06/17	→	FCP1676	TEVES

Concerto

1.4 16V	61	10/89	→ 08/91	FCP613	LUCAS/TRW	ABS
1.4 16V	61	10/89	→ 08/91	FCP472	AKEBONO	
1.5 16V	66	10/91	→ 05/95	FCP613	LUCAS/TRW	ABS
1.5 16V	66	10/91	→ 05/95	FCP472	AKEBONO	
1.6 16V	82, 90	10/89	→ 10/92	FCP613	LUCAS/TRW	
1.6 16V	82, 90	10/89	→ 10/92	FCP472	AKEBONO	

Coupe

1.6 16V		02/88	→ 12/91	FCP598	AKEBONO	
1.6 i VTEC Esi 16V	92	01/92	→	FCP776	AKEBONO	
1.6 i VTEC VTI 16V	92	01/92	→	FCP776	AKEBONO	
1.6 VTEC 16V		01/90	→ 12/91	FCP748	AKEBONO	

CR-V

2.0 i RD1 16V	94	06/97	→ 12/98	FCP905	AKEBONO	
2.0 i RD1 16V	94	01/99	→	FCP1436	AKEBONO	

CR-Z (ZF1)

1.5 Hybrid	84	06/10	→	FCP4404	AKEBONO	
1.5 Hybrid	84	06/10	→	FCP956	AKEBONO	
1.5 Hybrid	89	11/12	→	FCP4404	AKEBONO	
1.5 Hybrid	89	11/12	→	FCP956	AKEBONO	
1.5 Hybrid	91	09/10	→ 12/13	FCP4404	AKEBONO	
1.5 Hybrid	91	09/10	→ 12/13	FCP956	AKEBONO	

CRX II (ED, EE)

1.6 i 16V (ED9)	91	10/87	→ 02/92	FCP598	AKEBONO	
1.6 i 16V (ED9)	91	10/87	→ 02/92	FCP472	AKEBONO	
1.6 i 16V (ED9)	96	10/87	→ 12/89	FCP598	AKEBONO	
1.6 i 16V (ED9)	96	10/87	→ 12/89	FCP472	AKEBONO	
1.6 i 16V Vtec (EE8)	110	10/89	→ 02/92	FCP598	AKEBONO	
1.6 i 16V Vtec (EE8)	110	10/89	→ 02/92	FCP472	AKEBONO	

HR-V

1.6 16V	77	02/99	→	FCP905	AKEBONO	
---------	----	-------	---	--------	---------	--

INSIGHT (ZE_)

1.3 Hybrid	65	04/09	→	FCP4404	AKEBONO	
1.3 Hybrid	73	04/09	→	FCP4404	AKEBONO	

Integra (DC2)

1.8 Type R 16V	140	11/97	→	FCP905	AKEBONO	
1.8 Type R 16V	140	11/97	→	FCP956	NISSIN	

Integra (DC5)

2.0 16V type-R	162	02/02	→	FCP905	AKEBONO	
2.0 16V type-R	162	02/02	→	FCP1561	BREMBO	
2.0 16V type-R	162	02/02	→	FCP956	AKEBONO	

For material availability see page 16-18 / Per la disponibilità materiali vedere a pagina 16-18

FERODO

RACING

Updated on 17th Aug 2018



KW



...HONDA

Integra Coupe'

1.8 Type-R 11/97 → 01/98 FCP1436 AKEBONO

Jazz

1.2 i 57 03/02 → FCP777 AKEBONO

1.4 i 61 03/02 → FCP777 AKEBONO

JAZZ III (GE)

1.2 66 07/08 → FCP4404 AKEBONO

1.3 HYBRID 65 04/11 → FCP4404 AKEBONO

1.3 i 73 07/08 → FCP4404 AKEBONO

1.4 74 11/08 → FCP4404 AKEBONO

1.5 Flexfuel 88 07/08 → FCP4404 AKEBONO

1.5 i 88 07/08 → FCP4404 AKEBONO

Legend

2.5 UK Man. 24V 127 10/86 → 04/91 FCP748 AKEBONO

2.7 Jap. Man. 24V 124 01/85 → 12/91 FCP748 AKEBONO

2.7 UK Man. 24V 124 10/86 → 04/91 FCP748 AKEBONO

3.2 UK Man. 24V 151 04/91 → 12/95 FCP905 AKEBONO

3.2 UK Man. 24V 151 04/91 → 12/95 FCP956 NISSIN

3.5 24V 151 01/96 → FCP905 AKEBONO

Logo

1.3 i GA3 48 03/99 → 03/02 FCP777 AKEBONO

NSX

3.0 24V 201 09/90 → 12/96 FCP905 AKEBONO

Prelude

2.0 98 04/92 → FCP905 AKEBONO

2.0 98 04/92 → FCP956 NISSIN

2.0 BA 101 11/85 → 07/87 FCP472 AKEBONO

2.0 BA4 80 10/87 → 04/92 FCP598 AKEBONO

2.0 BA4 80 10/87 → 04/92 FCP472 AKEBONO

2.0 BA4 16V 110 10/87 → 12/91 FCP748 AKEBONO

2.0 BA4 16V 110 10/87 → 12/91 FCP472 AKEBONO

2.2 16V 136 01/93 → FCP905 AKEBONO

2.2 16V 136 01/93 → FCP956 NISSIN

2.3 BB 16V 118 04/92 → FCP905 AKEBONO

2.3 BB 16V 118 04/92 → FCP956 NISSIN

PRELUDE III (BA)

2.0 (BA4) 84 08/87 → 01/92 FCP598 AKEBONO

2.0 (BA4) 84 08/87 → 01/92 FCP472 AKEBONO

2.0 i EX 16V 101 04/86 → 12/87 FCP598 AKEBONO

2.0 i EX 16V 101 04/86 → 12/87 FCP472 AKEBONO

2.0 i EX 16V (BA2) 101 04/86 → 12/87 FCP598 AKEBONO

2.0 i EX 16V (BA2) 101 04/86 → 12/87 FCP472 AKEBONO

2.0 i EX 16V (BA4) 103 10/87 → 01/92 FCP598 AKEBONO

2.0 i EX 16V (BA4) 103 10/87 → 01/92 FCP472 AKEBONO

2.0 i EX 16V Cat (BA4) 101 04/87 → 01/92 FCP598 AKEBONO

2.0 i EX 16V Cat (BA4) 101 04/87 → 01/92 FCP472 AKEBONO

S2000

2.0 16V 178 06/99 → FCP1444 SUMITOMO

2.0 16V 178 06/99 → FCP956 NISSIN

Shuttle

2.2 ES 16V 110 01/94 → 12/97 FCP905 AKEBONO

2.2 ES 16V 110 01/94 → 12/97 FCP956 NISSIN

For material availability see page 16-18 / Per la disponibilità materiali vedere a pagina 16-18



KW



HUMBER

Sceptre

01/63 → 12/67

FCP823 LOCKHEED

NOTE

NOTE

HYUNDAI

Coupe

1.6 KG 16V	84	01/96 →	FCP600	AKEBONO
1.6 KG 16V	84	01/96 →		
2.0 16V	101	07/96 →	FCP600	AKEBONO
2.0 16V	101	07/96 →		

FCP638 SUMITOMO
FCP638 SUMITOMO

Equus / Centennial

5.0 GDI	320	09/11 →	FCP4671	MANDO
---------	-----	---------	---------	-------

i10

1.0	51	01/11 →	FCP1783	MANDO
1.1	48	12/07 →	FCP1783	MANDO
1.1	49	01/08 →	FCP1783	MANDO
1.1	51	04/11 →	FCP1783	MANDO
1.1 CRDi	55	01/08 →	FCP1783	MANDO
1.2	57	11/08 →	FCP1783	MANDO
1.2	63	04/11 →	FCP1783	MANDO

Lantra

1.6 16V	84	01/91 →	FCP600	AKEBONO
1.8 16V	93	01/91 → 05/95	FCP600	AKEBONO

Matrix

1.5 CRDi		10/01 →	FCP600	AKEBONO
1.6		06/01 →	FCP600	AKEBONO
1.8		06/01 →	FCP600	AKEBONO

Pony

1.2 Pick-up MkII	41	02/82 → 07/85	FCP810	LUCAS/TRW
1.4 II (B Series)	50	01/79 → 10/85	FCP810	LUCAS/TRW
1.6 Pick-up MkII		02/82 → 07/85	FCP810	LUCAS/TRW

Sonata

1.8	63	10/88 → 08/89	FCP600	AKEBONO
1.8	70	10/88 → 08/89	FCP600	AKEBONO
1.8	73	10/88 → 08/89	FCP600	AKEBONO
2.4	84	10/88 → 08/94	FCP600	AKEBONO
2.5 24V	118	06/98 →	FCP600	AKEBONO
3.0	107	08/89 → 06/96	FCP600	AKEBONO

SONATA II (Y-2)

2.0 i	80	01/91 → 10/93	FCP600	AKEBONO
2.0 i 16V	96	01/91 → 10/93	FCP600	AKEBONO

SONATA III (Y-3)

2.0 i	77	06/94 → 08/96	FCP600	AKEBONO
2.0 i 16V	102	05/93 → 06/98	FCP600	AKEBONO

Stellar

1.6	54, 55	09/83 → 12/86	FCP167	LUCAS/TRW
-----	--------	---------------	--------	-----------

Solid

Tiburon

1.6 i 16V	84	01/96 →	FCP600	AKEBONO
1.6 i 16V	84	01/96 →		
2.0 i 16V	101	07/96 →	FCP600	AKEBONO
2.0 i 16V	101	07/96 →		

FCP638 SUMITOMO
FCP638 SUMITOMO

For material availability see page 16-18 / Per la disponibilità materiali vedere a pagina 16-18



KW



INFINITI

FX

35	206	01/03 → 12/05	FCP1786	SUMITOMO
35	206	01/03 → 12/05	FCP1786	SUMITOMO
35	206	01/05 → 10/05	FCP1786	SUMITOMO
35	206	01/05 → 10/05	FCP1690	No BREMBO
35	206	11/05 → 12/06	FCP1690	No BREMBO
35	206	11/05 → 12/06	FCP1690	No BREMBO
35 All-wheel Drive	206	01/07 → 12/08	FCP1690	No BREMBO
35 All-wheel Drive	206	01/07 → 12/08	FCP1690	No BREMBO
37 AWD	235	10/08 → 06/09	FCP4172	AKEBONO
37 AWD	235	10/08 → 06/09	FCP4172	AKEBONO
45	232	01/03 → 12/05	FCP1786	SUMITOMO
45	232	01/03 → 12/05	FCP1786	SUMITOMO
45	232	01/05 → 10/05	FCP1786	SUMITOMO
45	232	01/05 → 10/05	FCP1690	No BREMBO
45	232	11/05 → 12/06	FCP1690	No BREMBO
45	232	11/05 → 12/06	FCP1690	No BREMBO
45 All-wheel Drive	232	01/07 → 12/08	FCP1690	No BREMBO
45 All-wheel Drive	232	01/07 → 12/08	FCP1690	No BREMBO
50 AWD	287	10/08 → 06/09	FCP4172	AKEBONO
50 AWD	287	10/08 → 06/09	FCP4172	AKEBONO

G20

G20		01/91 → 12/97	FCP600	AKEBONO
G20		01/98 → 12/00	FCP691	SUMITOMO

G35

RWD		01/05 → 12/06	FCP1690	No BREMBO
RWD		01/05 → 12/06	FCP1693	AKEBONO

I-30

I-30		01/96 → 12/98	FCP1430	SUMITOMO
------	--	---------------	---------	----------

M35

M35 / M35 X		01/06 → 12/08	FCP1690	No BREMBO
M35 / M35 X		01/06 → 12/08	FCP1693	AKEBONO

M45

M45 / M45 Sport		01/06 → 12/08	FCP1690	No BREMBO
M45 / M45 Sport		01/06 → 12/08	FCP1693	AKEBONO

INNOCENTI

Elba

1.3	48	01/91 → 12/92	FCP519	ATE
1.4	51	01/91 → 10/97	FCP519	ATE
1.5	56	01/91 → 08/94	FCP519	ATE
1.6	59	01/91 → 10/97	FCP519	ATE
1.7	52	01/91 → 03/93	FCP519	ATE

Koral

0.9	33	01/89 → 12/92	FCP29	BENDIX
1.1	42	01/89 → 12/92	FCP29	BENDIX

Mille

1.0	35	01/94 → 12/95	FCP519	ATE
1.0	35	01/95 →	FCP351	BENDIX
1.4	51	01/95 →	FCP351	BENDIX
1.7	42	01/94 → 12/97	FCP370	LUCAS/TRW

Regent

All i		01/73 →	FCP809	LUCAS/TRW
All models		01/73 → 12/80	FCP809	LUCAS/TRW

NOTE

NOTE

For material availability see page 16-18 / Per la disponibilità materiali vedere a pagina 16-18

1106

FERODO

RACING

Updated on 17th Aug 2018

INFINITI



KW



JAGUAR

420

					NOTE				NOTE	
4.2	01/67 → 12/68	FCP9	LUCAS/TRW							
Daimler Double Six										
5.3 Series II	09/73 → 12/78	FCP817	LUCAS/TRW							
5.3 Series II	09/73 → 12/78					FCP815	LUCAS/TRW			
5.3 V12 Series III	01/79 → 09/86	FCP817	LUCAS/TRW							
5.3 V12 Series III	01/79 → 09/86					FCP815	LUCAS/TRW			
E-Type										
5.3 24V	01/68 → 12/74	FCP9	LUCAS/TRW							
5.3 24V	01/68 → 12/74					FCP815	LUCAS/TRW			
Sovereign										
2.9	110, 123 09/90 → 09/97	FCP685	ATE							
2.9	110, 123 09/90 → 09/97					FCP578	ATE			
3.2 24V	149, 160 09/90 → 09/97	FCP685	ATE							
3.2 24V	149, 160 09/90 → 09/97					FCP578	ATE			
3.4 Series I (Daimler)	119 01/67 → 12/73	FCP9	LUCAS/TRW							
3.4 Series I (Daimler)	119 01/67 → 12/73					FCP815	LUCAS/TRW			
3.4 Series II (Daimler)	119 01/73 → 12/78	FCP817	LUCAS/TRW							
3.4 Series II (Daimler)	119 01/73 → 12/78					FCP815	LUCAS/TRW			
3.6 (Daimler) 24V	165 09/90 → 09/97	FCP685	ATE							
3.6 (Daimler) 24V	165 09/90 → 09/97					FCP578	ATE			
4.2 Series I (Daimler)	114, 124 01/67 → 12/73	FCP9	LUCAS/TRW							
4.2 Series I (Daimler)	114, 124 01/67 → 12/73					FCP815	LUCAS/TRW			
4.2 Series II (Daimler)	124 01/73 → 12/78	FCP817	LUCAS/TRW							
4.2 Series II (Daimler)	124 01/73 → 12/78					FCP815	LUCAS/TRW			
4.2 Series III (Daimler)	124 01/79 → 09/86	FCP817	LUCAS/TRW							
4.2 Series III (Daimler)	124 01/79 → 09/86					FCP815	LUCAS/TRW			
5.3 24V	196 09/90 → 12/92	FCP685	ATE							
5.3 24V	196 09/90 → 12/92					FCP578	ATE			
5.3 24V	196 01/93 → 09/97	FCP685	ATE							
5.3 24V	196 01/93 → 09/97					FCP578	ATE			
6.0	01/94 → 09/97	FCP685	ATE							
6.0	01/94 → 09/97					FCP578	ATE			
Vanden Plas										
4.2 Series III (Daimler)	124 01/79 → 09/86	FCP817	LUCAS/TRW							
4.2 Series III (Daimler)	124 01/79 → 09/86					FCP815	LUCAS/TRW			
5.3 V12 Series III (Daimler)	219 01/79 → 09/86	FCP817	LUCAS/TRW							
5.3 V12 Series III (Daimler)	219 01/79 → 09/86					FCP815	LUCAS/TRW			
XF (_J05_, CC9)										
2.2 D	120 04/11 →	FCP4045	ATE							
2.2 D	120 04/11 →					FCP1931	ATE			
2.2 D	140 05/11 →	FCP4045	ATE							
2.2 D	140 05/11 →					FCP1931	ATE			
XJ (X300, X330)										
4.0	183 11/94 → 07/97	FCP685	ATE							
4.0	183 11/94 → 07/97					FCP578	ATE			
6 Sovereign 4.0	177 09/94 → 07/97	FCP685	ATE							
6 Sovereign 4.0	177 09/94 → 07/97					FCP578	ATE			
R Super Charged 4.0	235 11/94 → 07/97	FCP685	ATE							
R Super Charged 4.0	235 11/94 → 07/97					FCP578	ATE			
XJ (XJ40, XJ81)										
6 2.9	108 10/86 → 08/90	FCP685	ATE							
6 2.9	108 10/86 → 08/90					FCP578	ATE			
6 2.9	117 10/86 → 08/90	FCP685	ATE							
6 2.9	117 10/86 → 08/90					FCP578	ATE			
6 2.9	123 10/86 → 08/90	FCP685	ATE							
6 2.9	123 10/86 → 08/90					FCP578	ATE			
XJ Coupe										
3.6	136 01/88 → 05/92	FCP817	LUCAS/TRW							
3.6	136 01/88 → 05/92					FCP815	LUCAS/TRW			
3.6	146 01/88 → 05/91	FCP817	LUCAS/TRW							
3.6	146 01/88 → 05/91					FCP815	LUCAS/TRW			
3.6	156 10/83 → 12/89					FCP815	LUCAS/TRW			
3.6	162 10/83 → 12/88	FCP817	LUCAS/TRW							
3.6	162 10/83 → 12/88					FCP815	LUCAS/TRW			

JAGUAR

For material availability see page 16-18 / Per la disponibilità materiali vedere a pagina 16-18



KW



...JAGUAR

XJ12

					NOTE			NOTE
5.3 24V	209, 227	09/90 → 12/92	FCP685	ATE				
5.3 24V	209, 227	09/90 → 12/92				FCP578	ATE	
5.3 24V	211	01/69 → 08/73	FCP9	LUCAS/TRW				
5.3 24V	211	01/69 → 08/73				FCP815	LUCAS/TRW	
5.3 24V	211	09/73 → 09/86	FCP817	LUCAS/TRW				
5.3 24V	211	09/73 → 09/86				FCP815	LUCAS/TRW	
6.0 24V	227	09/90 → 09/94	FCP685	ATE				
6.0 24V	227	09/90 → 09/94				FCP578	ATE	

XJ6

2.8	96	09/73 → 09/86	FCP817	LUCAS/TRW				
2.8	96	09/73 → 09/86				FCP815	LUCAS/TRW	
2.9	123	09/73 → 09/86	FCP817	LUCAS/TRW				
2.9	123	09/73 → 09/86				FCP815	LUCAS/TRW	
3.2 24V	146	09/90 → 12/94	FCP685	ATE				
3.2 24V	146	09/90 → 12/94				FCP578	ATE	
3.2 24V	146	10/94 → 09/97	FCP685	ATE				
3.2 24V	146	10/94 → 09/97				FCP578	ATE	
3.4	119	09/73 → 09/86	FCP817	LUCAS/TRW				
3.4	119	09/73 → 09/86				FCP815	LUCAS/TRW	
3.6 24V	149, 165	09/90 → 09/97	FCP685	ATE				
3.6 24V	149, 165	09/90 → 09/97				FCP578	ATE	
4.0 24V	163, 229	09/90 → 09/97	FCP685	ATE				
4.0 24V	163, 229	09/90 → 09/97				FCP578	ATE	
4.2	130	09/73 → 09/86	FCP817	LUCAS/TRW				
4.2	130	09/73 → 09/86				FCP815	LUCAS/TRW	
6.0 i	229	09/90 → 09/94	FCP685	ATE				
6.0 i	229	09/90 → 09/94				FCP578	ATE	

XJR

4.0 i 24V	240	09/94 →	FCP817	LUCAS/TRW				
4.0 i 24V	240	09/94 →				FCP815	LUCAS/TRW	

XJR-S

5.3		08/88 → 09/89	FCP817	LUCAS/TRW				
5.3		08/88 → 09/89				FCP815	LUCAS/TRW	
5.3 Le Mans Ltd Edn		09/90 → 04/91	FCP685	ATE				
5.3 Le Mans Ltd Edn		09/90 → 04/91				FCP578	ATE	
6.0		09/89 → 05/93	FCP685	ATE				
6.0		09/89 → 05/93				FCP578	ATE	

XJS

3.6 24V	146	01/90 → 05/91	FCP685	ATE				
3.6 24V	146	01/90 → 05/91				FCP578	ATE	
4.0 24V	163, 171	01/87 → 09/96	FCP685	ATE				
4.0 24V	163, 171	01/87 → 09/96				FCP578	ATE	
5.3 24V	194	01/75 → 12/89	FCP817	LUCAS/TRW				
5.3 24V	194	01/75 → 12/89				FCP815	LUCAS/TRW	
5.3 i 24V	202	01/90 → 12/93	FCP685	ATE				
5.3 i 24V	202	01/90 → 12/93				FCP578	ATE	
6.0 i 24V	227	05/93 → 05/95	FCP685	ATE				
6.0 i 24V	227	05/93 → 05/95				FCP578	ATE	

XJSC Convertible (X27)

3.6	136	08/87 → 05/91	FCP817	LUCAS/TRW				
3.6	136	08/87 → 05/91				FCP815	LUCAS/TRW	
3.6	156	08/87 → 05/91	FCP817	LUCAS/TRW				
3.6	156	08/87 → 05/91				FCP815	LUCAS/TRW	
3.6	162	10/86 → 12/88	FCP817	LUCAS/TRW				
3.6	162	10/86 → 12/88				FCP815	LUCAS/TRW	

XK Convertible (_J43_)

3.6	190	10/07 → 07/14	FRP3134	ALCON	for vehicles with Performance brakes			
3.6	190	10/07 → 07/14				FRP3135	ALCON	for vehicles with Performance brakes
4.2 XK	224	02/08 → 07/14	FRP3134	ALCON	for vehicles with Performance brakes			
4.2 XK	224	02/08 → 07/14				FRP3135	ALCON	for vehicles with Performance brakes
4.2 XK8	219	03/06 → 07/14	FRP3134	ALCON	for vehicles with Performance brakes			
4.2 XK8	219	03/06 → 07/14				FRP3135	ALCON	for vehicles with Performance brakes
4.2 XKR	306	03/06 → 07/14	FRP3134	ALCON	for vehicles with Performance brakes			
4.2 XKR	306	03/06 → 07/14				FRP3135	ALCON	for vehicles with Performance brakes
4.2 XKR	313	08/06 → 07/14	FRP3134	ALCON	for vehicles with Performance brakes			
4.2 XKR	313	08/06 → 07/14				FCP1931	ATE	
4.2 XKR	313	08/06 → 07/14				FRP3135	ALCON	for vehicles with Performance brakes
5.0 V8	283	01/09 → 07/14	FRP3134	ALCON	for vehicles with Performance brakes			
5.0 V8	283	01/09 → 07/14				FRP3135	ALCON	for vehicles with Performance brakes
5.0 XKR	375	01/09 → 07/14	FRP3134	ALCON	for vehicles with Performance brakes			

For material availability see page 16-18 / Per la disponibilità materiali vedere a pagina 16-18



KW



...JAGUAR

...XK Convertible (_J43_)

					NOTE			NOTE
5.0 XKR	375	01/09 → 07/14						
5.0 XKR-S	405	01/11 → 07/14	FRP3134	ALCON	for vehicles with Performance brakes	FRP3135	ALCON	for vehicles with Performance brakes
5.0 XKR-S	405	01/11 → 07/14				FRP3135	ALCON	for vehicles with Performance brakes

XK Coupe (QQ6_, _J43_)

3.5	190	07/07 → 07/14	FRP3134	ALCON	for vehicles with Performance brakes			
3.5	190	07/07 → 07/14				FRP3135	ALCON	for vehicles with Performance brakes
4.2 XK	224	02/08 → 07/14	FRP3134	ALCON	for vehicles with Performance brakes			
4.2 XK	224	02/08 → 07/14				FRP3135	ALCON	for vehicles with Performance brakes
4.2 XK8	219	03/06 → 07/14	FRP3134	ALCON	for vehicles with Performance brakes			
4.2 XK8	219	03/06 → 07/14				FRP3135	ALCON	for vehicles with Performance brakes
4.2 XKR	291	03/06 → 07/14	FRP3134	ALCON	From Ch.No.: B00379			
4.2 XKR	291	03/06 → 07/14				FRP3135	ALCON	From Ch.No.: B00379
4.2 XKR	306	03/06 → 07/14	FRP3134	ALCON	for vehicles with Performance brakes			
4.2 XKR	306	03/06 → 07/14				FRP3135	ALCON	for vehicles with Performance brakes
4.2 XKR	313	08/06 → 07/14	FRP3134	ALCON	for vehicles with Performance brakes			
4.2 XKR	313	08/06 → 07/14				FCP1931	ATE	
5.0 V8	283	01/09 → 07/14	FRP3134	ALCON	for vehicles with Performance brakes			
5.0 V8	283	01/09 → 07/14				FRP3135	ALCON	for vehicles with Performance brakes
5.0 XKR	375	01/09 → 07/14	FRP3134	ALCON	for vehicles with Performance brakes			
5.0 XKR	375	01/09 → 07/14				FRP3135	ALCON	for vehicles with Performance brakes
5.0 XKR	390	09/10 → 07/14	FRP3134	ALCON				
5.0 XKR-S	405	01/11 → 07/14	FRP3134	ALCON	for vehicles with Performance brakes			
5.0 XKR-S	405	01/11 → 07/14				FRP3135	ALCON	for vehicles with Performance brakes

XK8

4.0 V8 32V	216	10/96 →	FCP685	ATE				
4.0 V8 32V	216	10/96 →				FCP578	ATE	

JEEP

Cherokee

2.5	78	01/77 → 12/83	FRP3057	KELGATE				
2.8	83	01/77 → 12/83	FRP3057	KELGATE				
4.2	81	01/77 → 12/83	FRP3057	KELGATE				
5.9 16V	128	01/77 → 12/83	FRP3057	KELGATE				

Comanche

		01/86 → 12/89	FRP3057	KELGATE				
--	--	---------------	---------	---------	--	--	--	--

Grand Cherokee IV (WK, WK2)

6.4 SRT8 4x4	344	03/11 →	FRP3133	BREMBO	For Perforated/Vented brake discs			
--------------	-----	---------	---------	--------	-----------------------------------	--	--	--

Grand Wrangler

2.5		01/84 → 12/91	FRP3057	KELGATE				
4.0		01/84 → 12/91	FRP3057	KELGATE				
4.2		01/84 → 12/91	FRP3057	KELGATE				
5.2		01/84 → 12/91	FRP3057	KELGATE				

J10

4.2	81	01/74 → 12/87	FRP3057	KELGATE				
5.9 16V	108, 128	01/74 → 12/87	FRP3057	KELGATE				

J20

4.2	81	01/74 → 12/87	FRP3057	KELGATE				
5.9 16V	108, 128	01/74 → 12/87	FRP3057	KELGATE				

Wagoneer

2.5	76	01/77 → 12/83	FRP3057	KELGATE				
4.2	81	01/77 → 12/83	FRP3057	KELGATE				
5.9 16V	120, 128	01/77 → 12/83	FRP3057	KELGATE				

JENSEN

For material availability see page 16-18 / Per la disponibilità materiali vedere a pagina 16-18



KW

**JENSEN****FF**

6.3 16V	89	01/68 → 12/71	FCP9	LUCAS/TRW			
6.3 16V	89	01/68 → 12/71			FCP815	LUCAS/TRW	

Healey

2.0	88	01/72 → 12/76	FCP810	LUCAS/TRW			
-----	----	---------------	--------	-----------	--	--	--

Interceptor

7.2 16V		01/68 → 12/71	FCP9	LUCAS/TRW			
7.2 16V		01/68 → 12/71			FCP815	LUCAS/TRW	

SP V8

	283	01/71 → 12/72	FCP9	LUCAS/TRW			
	283	01/71 → 12/72			FCP815	LUCAS/TRW	

KIA**Picanto (BA)**

1.0	45	04/04 →	FCP1783	MANDO			
1.0	45	11/09 →	FCP1783	MANDO			
1.1	48	04/04 →	FCP1783	MANDO			
1.1 CRDi	55	11/05 →	FCP1783	MANDO			

Sephia

1.5 16V	59	02/96 → 12/98	FCP206	ATE			
1.5 i 16V	59	02/96 → 12/98	FCP206	ATE			

Venga (YN)

1.4 CRDi 75	55	02/10 →			FCP1521	LUCAS/TRW	
1.4 CRDi 75	57	02/10 →			FCP1521	LUCAS/TRW	
1.4 CRDi 90	66	02/10 →			FCP1521	LUCAS/TRW	
1.4 CVVT	66	02/10 →			FCP1521	LUCAS/TRW	
1.6		02/10 →	FRP3084	AP RACING			
1.6		02/10 →			FCP1521	LUCAS/TRW	
1.6 CRDi 115	85	02/10 →			FCP1521	LUCAS/TRW	
1.6 CRDi 128	94	02/10 →			FCP1521	LUCAS/TRW	

LADA**1200**

1.2	46	06/72 → 09/86	FCP96	BENDIX			
-----	----	---------------	-------	--------	--	--	--

1300

1.3	49	08/74 → 05/83	FCP96	BENDIX			
-----	----	---------------	-------	--------	--	--	--

1500

1.5	55	11/72 → 07/85	FCP96	BENDIX			
-----	----	---------------	-------	--------	--	--	--

1600

1.6	57	01/75 → 07/92	FCP96	BENDIX			
-----	----	---------------	-------	--------	--	--	--

Forma

1.1		07/91 →	FCP527	LUCAS/TRW			
1.3		03/92 → 05/95	FCP527	LUCAS/TRW			
1.5		03/92 → 05/95	FCP527	LUCAS/TRW			

Nova

1.2	46	01/70 → 10/90	FCP96	BENDIX			
1.3	49	01/75 → 05/91	FCP96	BENDIX			
1.5	52, 55	01/75 → 05/91	FCP96	BENDIX			
1.6	57	01/75 → 05/91	FCP96	BENDIX			
1.7	62	06/94 → 10/98	FCP96	BENDIX			

Priora

1.6	60	12/08 →	FCP527	LUCAS/TRW			
1.6	73	02/08 →	FCP527	LUCAS/TRW			
1.6 LPG	71	03/09 →	FCP527	LUCAS/TRW			

For material availability see page 16-18 / Per la disponibilità materiali vedere a pagina 16-18

1110

FERODO

RACING

Updated on 17th Aug 2018

JENSEN



KW



...LADA

Riva

All Models 11/72 → 07/85 **FCP96** BENDIX

Samara

1.1 07/90 → 10/92 **FCP527** LUCAS/TRW
 1.3 03/85 → 10/92 **FCP527** LUCAS/TRW
 1.5 03/85 → 05/95 **FCP527** LUCAS/TRW

Toscana

1.3 48 12/85 → **FCP96** BENDIX
 1.5 55 09/83 → 02/93 **FCP96** BENDIX

LAMBORGHINI

Contach

LP400 283 01/74 → 12/82 **FCP399** ATE
 LP500 324 01/74 → 12/74 **FCP399** ATE
 LP500 S 276 01/82 → 12/85 **FCP399** ATE
 S Quattrovalvole 313 01/85 → 12/91 **FCP399** ATE

Diablo

GT 5.9 423 10/99 → **FCP1664** BREMBO
 GT 5.9 423 10/99 → **FCP1281** BREMBO
 GT2 470 01/98 → **FCP1664** BREMBO
 GT2 470 01/98 → **FCP1281** BREMBO
 SE 386 01/94 → 12/96 **FCP399** ATE
 SV 390 01/98 → **FCP1664** BREMBO
 SV 390 01/98 → **FCP1281** BREMBO
 VT 361 01/90 → 08/98 **FCP399** ATE
 VT 390 08/98 → **FCP1664** BREMBO
 VT 390 08/98 → **FCP1281** BREMBO

Diablo Roadster

5.7 390 01/98 → **FCP1664** BREMBO
 5.7 390 01/98 → **FCP1281** BREMBO

Gallardo

5.0 368 08/03 → **FCP1664** BREMBO
 5.0 368 08/03 → **FCP1281** BREMBO
 5.0 382 07/05 → **FCP1664** BREMBO
 5.0 382 07/05 → **FCP1281** BREMBO
 SPYDER 5.2 LP560-4 412 11/08 → **FCP1664** BREMBO
 SPYDER 5.2 LP560-4 412 11/08 → **FCP1281** BREMBO

Gallardo Spyder

5.0 382 08/05 → **FCP1664** BREMBO
 5.0 382 08/05 → **FCP1281** BREMBO

Jalpa

P350 188 01/82 → 12/87 **FCP399** BREMBO

Murcielago

6.2 426 11/01 → **FCP1664** BREMBO
 6.2 426 11/01 → **FCP1281** BREMBO
 LP640 471 04/06 → **FCP1664** BREMBO
 LP640 471 04/06 → **FCP1281** BREMBO

Murcielago Roadster

6.2 426 08/04 → **FCP1664** BREMBO
 6.2 426 08/04 → **FCP1281** BREMBO

Urraco

P200 133 01/75 → 12/81 **FCP399** ATE
 P200 133 01/75 → 12/81 **FCP809** LUCAS/TRW
 P250 162 01/74 → 12/81 **FCP399** ATE
 P250 162 01/74 → 12/81 **FCP809** LUCAS/TRW
 P300 195 01/74 → 12/81 **FCP399** ATE
 P300 195 01/74 → 12/81 **FCP809** LUCAS/TRW

LANCIA

For material availability see page 16-18 / Per la disponibilità materiali vedere a pagina 16-18



KW

**LANCIA**

NOTE

NOTE

A112

0.9	34	08/68 → 06/84	FCP29	BENDIX			
1.0	52	08/68 → 06/84	FCP29	BENDIX			

Beta

2.0 Montecarlo	85, 88	01/75 → 12/77	FCP29	BENDIX			
----------------	--------	---------------	-------	--------	--	--	--

Dedra

1.6 i ie	55	10/94 → 06/96	FCP524	LUCAS/TRW			
1.6 i ie	55	10/94 → 06/96	FCP370	LUCAS/TRW	ABS		
1.6 i ie	55	10/94 → 06/96				FCP409	LUCAS/TRW ABS
1.6 i ie	55	10/94 → 06/96				FCP1324	LUCAS/TRW C34
1.6 i ie	55	10/94 → 06/96				FCP1349	LUCAS/TRW C38
1.6 i ie	55	07/96 → 02/97				FCP409	LUCAS/TRW ABS
1.6 i ie	55	07/96 → 02/97				FCP1324	LUCAS/TRW C34
1.6 i ie	55	07/96 → 02/97				FCP1349	LUCAS/TRW C38

1.6 i ie	55, 57	09/89 → 09/94	FCP524	LUCAS/TRW			
1.6 i ie	55, 57	09/89 → 09/94	FCP370	LUCAS/TRW	ABS		
1.6 i ie	55, 57	09/89 → 09/94				FCP409	LUCAS/TRW ABS

1.8	66, 74	10/94 → 06/96	FCP524	LUCAS/TRW			
1.8	66, 74	10/94 → 06/96	FCP370	LUCAS/TRW	ABS		

1.8	66, 74	10/94 → 06/96				FCP360	BENDIX
1.8	66, 74	10/94 → 06/96				FCP409	LUCAS/TRW ABS
1.8	66, 74	10/94 → 06/96				FCP1324	LUCAS/TRW C34
1.8	66, 74	10/94 → 06/96				FCP1349	LUCAS/TRW C38

1.8	66, 74	10/94 → 06/96					
1.8	66, 77	09/89 → 09/94	FCP524	LUCAS/TRW			
1.8	66, 77	09/89 → 09/94	FCP370	LUCAS/TRW	ABS		
1.8	66, 77	09/89 → 09/94				FCP360	BENDIX
1.8	66, 77	09/89 → 09/94				FCP409	LUCAS/TRW ABS

1.8	83, 96	07/96 → 04/97	FCP1056	ATE			
1.8	83, 96	07/96 → 04/97				FCP360	BENDIX
1.8	83, 96	07/96 → 04/97				FCP409	LUCAS/TRW ABS
1.8	83, 96	07/96 → 04/97				FCP1324	LUCAS/TRW C34
1.8	83, 96	07/96 → 04/97				FCP1349	LUCAS/TRW C38

1.9 TD	66	09/89 → 09/94	FCP524	LUCAS/TRW			
1.9 TD	66	09/89 → 09/94	FCP370	LUCAS/TRW	ABS		
1.9 TD	66	09/89 → 09/94				FCP360	BENDIX
1.9 TD	66	09/89 → 09/94				FCP409	LUCAS/TRW ABS

1.9 TD	66	10/94 → 06/96	FCP524	LUCAS/TRW			
1.9 TD	66	10/94 → 06/96	FCP370	LUCAS/TRW	ABS		
1.9 TD	66	10/94 → 06/96				FCP360	BENDIX
1.9 TD	66	10/94 → 06/96				FCP409	LUCAS/TRW ABS
1.9 TD	66	10/94 → 06/96				FCP1324	LUCAS/TRW C34
1.9 TD	66	10/94 → 06/96				FCP1349	LUCAS/TRW C38

1.9 TD	66	07/96 → 04/97	FCP1056	ATE			
1.9 TD	66	07/96 → 04/97				FCP360	BENDIX
1.9 TD	66	07/96 → 04/97				FCP409	LUCAS/TRW ABS
1.9 TD	66	07/96 → 04/97				FCP1324	LUCAS/TRW C34
1.9 TD	66	07/96 → 04/97				FCP1349	LUCAS/TRW C38

2.0 16V	102	07/94 → 12/97	FCP370	LUCAS/TRW			
2.0 16V	102	07/94 → 12/97				FCP409	LUCAS/TRW

2.0 HF Integrale (Turbo)	130	12/90 → 12/94	FCP565	LUCAS/TRW			
2.0 HF Integrale (Turbo)	130	12/90 → 12/94				FCP409	LUCAS/TRW

2.0 HF Integrale (Turbo)	130	01/94 → 12/97	FCP1052	ATE			
2.0 HF Integrale (Turbo)	130	01/94 → 12/97				FCP409	LUCAS/TRW

2.0 HF Integrale (Turbo)	130	01/98 →	FCP1052	ATE			
2.0 HF Integrale (Turbo)	130	01/98 →				FCP1324	LUCAS/TRW C34
2.0 HF Integrale (Turbo)	130	01/98 →				FCP1349	LUCAS/TRW C38

2.0 i.e. Not Integrale	83	09/89 → 12/94	FCP370	LUCAS/TRW			
2.0 i.e. Not Integrale	83	09/89 → 12/94				FCP360	BENDIX
2.0 i.e. Not Integrale	83	09/89 → 12/94				FCP409	LUCAS/TRW ABS

2.0 i.e. Not Integrale	83	01/94 → 12/97	FCP1052	ATE			
2.0 i.e. Not Integrale	83	01/94 → 12/97				FCP409	LUCAS/TRW

2.0 i.e. Not Integrale	83	01/98 →	FCP1052	ATE			
2.0 i.e. Not Integrale	83	01/98 →				FCP1324	LUCAS/TRW C34
2.0 i.e. Not Integrale	83	01/98 →				FCP1349	LUCAS/TRW C38

Delta

1.6		01/86 → 12/87				FCP360	BENDIX
1.6 16V	66, 76	05/96 →				FCP409	LUCAS/TRW

1.6 i.e. (II)	55	01/93 → 04/96	FCP370	LUCAS/TRW			
1.6 Turbo HF		01/83 → 05/86	FCP370	LUCAS/TRW			
1.6 Turbo HF		01/83 → 05/86				FCP360	BENDIX

1.8	76	01/93 → 04/96	FCP370	LUCAS/TRW			
1.8	76	01/93 → 04/96				FCP409	LUCAS/TRW

1.8 16V	83	01/96 → 05/97	FCP1056	ATE			
1.8 16V	83	01/96 → 05/97				FCP409	LUCAS/TRW

1.8 16V	83	06/97 → 04/98	FCP1056	ATE			
---------	----	---------------	---------	-----	--	--	--

For material availability see page 16-18 / Per la disponibilità materiali vedere a pagina 16-18

1112

FERODO

RACING

Updated on 17th Aug 2018



KW

**...LANCIA****...Delta**

					NOTE			NOTE
1.8 16V	83	06/97 → 04/98				FCP1113	LUCAS/TRW	
1.8 LE, LX, GT 16V	96	05/96 → 05/97	FCP1052	ATE				
1.8 LE, LX, GT 16V	96	05/96 → 05/97				FCP409	LUCAS/TRW	
1.8 LE, LX, GT 16V	96	06/97 → 04/98	FCP1052	ATE				
1.8 LE, LX, GT 16V	96	06/97 → 04/98				FCP1113	LUCAS/TRW	
1.9 TD	66	01/85 → 12/93	FCP370	LUCAS/TRW				
1.9 TD HPE	66	01/94 → 05/96	FCP370	LUCAS/TRW				
1.9 TD HPE	66	01/94 → 05/96				FCP409	LUCAS/TRW	
1.9 TD HPE	66	01/94 → 05/96				FCP1113	LUCAS/TRW	
1.9 TD HPE	66	06/96 →	FCP1056	ATE				
1.9 TD HPE	66	06/96 →				FCP409	LUCAS/TRW	
1.9 TD HPE	66	06/96 →				FCP1113	LUCAS/TRW	
2.0 Evoluzione 4x4 (Turbo) 16V	155, 158	01/91 → 12/93	FCP721	BREMBO				
2.0 Evoluzione 4x4 (Turbo) 16V	155, 158	01/91 → 12/93				FCP726	LUCAS/TRW	
2.0 HF		05/96 →	FCP1052	ATE				
2.0 HPE (II) HF 16V		05/93 →	FCP565	LUCAS/TRW				
2.0 HPE (II) HF 16V		05/93 →	FCP1052	ATE				
2.0 HPE (II) HF 16V		05/93 →				FCP409	LUCAS/TRW	
2.0 HPE (II) HF 16V		05/93 →				FCP1113	LUCAS/TRW	
2.0 i ie (Turbo) 16V		03/91 → 12/93	FCP370	LUCAS/TRW				
2.0 i ie (Turbo) 16V		03/91 → 12/93				FCP409	LUCAS/TRW	
2.0 i ie (Turbo) 16V		05/93 →	FCP565	LUCAS/TRW				
2.0 i ie (Turbo) 16V		05/93 →	FCP1052	ATE				
2.0 i ie (Turbo) 16V		05/93 →				FCP409	LUCAS/TRW	
2.0 i ie (Turbo) 16V		05/93 →				FCP1113	LUCAS/TRW	
2.0 i.e. GT/ HPE (II) 16V		05/93 → 12/95	FCP370	LUCAS/TRW				
2.0 i.e. GT/ HPE (II) 16V		05/93 → 12/95				FCP409	LUCAS/TRW	
2.0 Integrale 4x4 (Turbo) 16V	155, 158	03/91 → 04/96	FCP565	LUCAS/TRW				
2.0 Integrale 4x4 (Turbo) 16V	155, 158	03/91 → 04/96				FCP409	LUCAS/TRW	
2.0 Integrale/Evoluzione HF		01/92 → 12/95	FCP721	BREMBO				
2.0 Integrale/Evoluzione HF		01/92 → 12/95				FCP726	LUCAS/TRW	
2.0 Turbo 4WD HF		01/86 → 10/87	FCP370	LUCAS/TRW				
2.0 Turbo 4WD HF		01/86 → 10/87				FCP360	BENDIX	
2.0 Turbo HF		06/86 → 05/93	FCP370	LUCAS/TRW				
2.0 Turbo HF		06/86 → 05/93				FCP360	BENDIX	

DELTA I (831_)

2.0 16V HF Integrale (831AB.026)	144	03/89 → 09/91	FCP565	LUCAS/TRW				
2.0 16V HF Integrale (831AB.026)	144	03/89 → 09/91				FCP360	BENDIX	
2.0 HF Integrale (831AB.019)	122	11/86 → 08/88	FCP565	LUCAS/TRW				
2.0 HF Integrale (831AB.019)	122	11/86 → 08/88				FCP360	BENDIX	
2.0 HF Integrale (831AB.024)	133	10/87 → 12/91	FCP565	LUCAS/TRW				
2.0 HF Integrale (831AB.024)	133	10/87 → 12/91				FCP360	BENDIX	
2.0 HF Integrale (831AB.024S, 831AB.028)	130	12/86 → 12/92	FCP565	LUCAS/TRW				
2.0 HF Integrale (831AB.024S, 831AB.028)	130	12/86 → 12/92				FCP360	BENDIX	

DELTA III (844)

1.4	110	09/08 →	FCP1468	BOSCH				
1.4	110	09/08 →				FCP1469	BOSCH	

Flavia Berlina

2.0	85	05/71 → 12/74				FCP809	LUCAS/TRW	
-----	----	---------------	--	--	--	--------	-----------	--

Flavia Coupe

2.0	85	05/71 → 12/73				FCP809	LUCAS/TRW	
-----	----	---------------	--	--	--	--------	-----------	--

Fulvia Berlina

1.2	58	08/70 → 12/72				FCP809	LUCAS/TRW	
1.3	62	08/70 → 12/72				FCP809	LUCAS/TRW	

Fulvia Coupe

1.3	65	01/70 → 07/75				FCP809	LUCAS/TRW	
1.3	66	08/70 → 12/76				FCP809	LUCAS/TRW	
1.6	84	08/70 → 12/73				FCP809	LUCAS/TRW	

Kappa

2.0 20V	107, 114	01/94 → 08/96	FCP565	LUCAS/TRW				
2.0 20V	107, 114	01/94 → 08/96				FCP995	LUCAS/TRW	
2.0 i SW 20V	114	01/96 → 12/98				FCP995	LUCAS/TRW	
2.0 i Turbo 20V	162	05/98 →	FCP1334	BREMBO				
2.0 Turbo 16V	151	01/94 → 08/96	FCP565	LUCAS/TRW				
2.0 Turbo 16V	151	01/94 → 08/96				FCP995	LUCAS/TRW	
2.0 Turbo 20V	162	10/98 → 10/01	FCP565	LUCAS/TRW				
2.0 Turbo 20V	162	10/98 → 10/01	FCP1334	BREMBO				
2.4 JTD	100	05/98 →				FCP995	LUCAS/TRW	
2.4 TD	91	01/94 → 10/01	FCP565	LUCAS/TRW				

For material availability see page 16-18 / Per la disponibilità materiali vedere a pagina 16-18



KW

**...LANCIA**

NOTE

NOTE

...Kappa

2.4 TD	91	01/94 → 10/01
3.0 24V	150	01/94 → 09/98
3.0 24V	150	01/94 → 09/98
3.0 24V	150	10/98 → 10/01
3.0 24V	150	10/98 → 10/01
3.0 24V	150	10/98 → 10/01
3.0 i 24V	150	05/98 → 10/01
3.0 i 24V	150	05/98 → 10/01

FCP565	LUCAS/TRW
FCP565	LUCAS/TRW
FCP1334	BREMBO
FCP1334	BREMBO

FCP995	LUCAS/TRW
FCP995	LUCAS/TRW
FCP995	LUCAS/TRW
FCP995	LUCAS/TRW
FCP995	LUCAS/TRW

Lybra

1.6 16V	76	07/99 →
1.7 16V	96	07/99 →
1.8 16V	96	07/99 →
1.9 JTD	77	07/99 →
2.0 20V	114	07/99 →
2.4 JTD	100	07/99 →

FCP1349	LUCAS/TRW
FCP1349	LUCAS/TRW
FCP1349	LUCAS/TRW
FCP1349	LUCAS/TRW
FCP1349	LUCAS/TRW
FCP1349	LUCAS/TRW

MUSA (350)

1.9 i Multijet	74	09/04 →
----------------	----	---------

FCP1467	BOSCH
---------	-------

Prisma

1.6 4WD	66	01/86 → 12/89
1.6 4WD	73	01/86 → 12/89
1.6 4WD	80	01/86 → 12/89
1.6 i	77	01/83 → 12/84
1.9 TD	59	01/85 → 12/89
2.0 4WD	85	04/86 → 12/89

FCP360	BENDIX
FCP360	BENDIX
FCP360	BENDIX
FCP360	BENDIX
FCP370	LUCAS/TRW
FCP360	BENDIX

PRISMA (831_)

1.6	73	08/86 → 02/92
1.6	73	08/86 → 02/92
1.6	77	01/83 → 04/86
1.6	77	01/83 → 04/86
1.6 i.e.	80	05/86 → 12/89
1.6 i.e.	80	05/86 → 12/89
1.6 i.e. Super	66	05/87 → 12/89
1.6 i.e. Super	66	05/87 → 12/89

FCP370	LUCAS/TRW
FCP360	BENDIX
FCP370	LUCAS/TRW
FCP360	BENDIX
FCP370	LUCAS/TRW
FCP360	BENDIX
FCP370	LUCAS/TRW
FCP360	BENDIX

Stratos

All i		01/73 →
All i		01/73 →
All Models		01/73 →
All Models		01/73 →

FCP11	ATE
FCP11	ATE

FCP2	ATE
FCP2	ATE

Thema

2.0 (Turbo) 16V	148	10/92 → 05/95
2.0 (Turbo) 16V	148	10/92 → 05/95
2.0 (Turbo) 16V	148	10/92 → 05/95
2.0 16V	112	08/92 → 12/93
2.0 16V	112	08/92 → 12/93
2.4 TD	74	01/84 → 09/88
2.4 TD SW Estate	74	01/86 → 09/88
2.5 TD	87	01/84 → 12/87
2.5 TD SW Estate	87	01/88 → 12/94
2.5 TD SW Estate	87	01/88 → 12/94
2.8 V6	108	10/85 → 12/87
2.9 8.32 32V	158	01/86 → 09/88
2.9 8.32 32V	158	01/86 → 09/88
2.9 8.32 32V	158	09/88 → 12/94
2.9 8.32 32V	158	09/88 → 12/94
3.0 V6	126	01/91 → 12/94
3.0 V6	126	01/91 → 12/94
3.0 V6	126	01/91 → 12/94

FCP565	LUCAS/TRW
FCP596	LUCAS/TRW
FCP360	BENDIX
FCP565	LUCAS/TRW
FCP596	LUCAS/TRW
FCP360	BENDIX
FCP360	BENDIX
FCP596	LUCAS/TRW
FCP565	LUCAS/TRW
FCP596	LUCAS/TRW
FCP596	LUCAS/TRW
FCP596	LUCAS/TRW
FCP565	LUCAS/TRW
FCP596	LUCAS/TRW
FCP596	LUCAS/TRW
FCP596	LUCAS/TRW
FCP596	LUCAS/TRW
FCP596	LUCAS/TRW
FCP596	LUCAS/TRW
FCP596	LUCAS/TRW
FCP596	LUCAS/TRW

THEMA (834_)

2000 i.e.	83	03/86 → 09/88
2000 i.e. (834B)	88	11/84 → 09/88
2000 i.e. (834BV)	85	09/87 → 05/92
2000 i.e. Turbo (834C)	122	11/84 → 12/89

FCP596	LUCAS/TRW
FCP596	LUCAS/TRW
FCP596	LUCAS/TRW
FCP596	LUCAS/TRW

Y (840A)

1.1 i		01/97 → 05/03
1.1 i	40	01/97 → 05/03
1.1 i	40	01/97 → 05/03
1.2 16V	63	01/97 → 05/03
1.2 i 16V	63	01/97 → 05/03

FCP1160	ATE
FCP1160	ATE
FCP925	BENDIX
FCP1160	ATE
FCP1160	ATE

FCP1160	ATE
FCP1160	ATE
FCP1160	ATE
FCP1160	ATE
FCP1160	ATE

For material availability see page 16-18 / Per la disponibilità materiali vedere a pagina 16-18

1114

FERODO

RACING

Updated on 17th Aug 2018

LANCIA



KW



!



!

...LANCIA

...Y (840A)

1.2 i LE, LS	44	02/96 → 07/97	FCP925	BENDIX
1.2 LE, LS	44	02/96 → 07/97	FCP925	BENDIX
1.4 i LS, LX	55	02/96 → 02/98	FCP370	LUCAS/TRW
1.4 i LS, LX	55	02/96 → 02/98	FCP1160	ATE
1.4 LS, LX	55	02/96 → 02/98	FCP925	BENDIX

Y10

1.0	32, 33	06/85 → 06/91	FCP351	BENDIX
1.0	32, 33	06/85 → 06/91	FCP370	LUCAS/TRW
1.0 (Turbo)	62	03/85 → 02/89	FCP370	LUCAS/TRW
1.0 Selectronic		01/90 → 12/96	FCP351	BENDIX
1.1	37	05/89 → 12/96	FCP351	BENDIX
1.1 i		11/92 → 12/96	FCP351	BENDIX
1.2	44	11/95 → 12/99	FCP925	BENDIX
1.3	54, 57	07/89 → 10/91	FCP351	BENDIX
1.3 GT		06/93 → 12/96	FCP351	BENDIX
1.3 GT	53	11/87 → 05/93	FCP370	LUCAS/TRW
1.4	55, 59	01/96 → 05/03	FCP370	LUCAS/TRW

Zeta

1.9		10/95 → 09/02	FCP565	LUCAS/TRW
2.0	108	10/95 → 09/02	FCP565	LUCAS/TRW
2.0 (Turbo)	108	10/95 → 09/02	FCP565	LUCAS/TRW
2.0 (Turbo)	108	10/95 → 09/02		FCP850 ATE
2.0 JTD		06/99 → 09/02	FCP565	LUCAS/TRW
2.0 JTD		06/99 → 09/02		FCP850 ATE
2.1 TD	80	07/94 → 09/02	FCP565	LUCAS/TRW
2.1 TD	80	07/94 → 09/02		FCP850 ATE

LAND ROVER

Freelander

1.8 16V	88	01/98 → 10/00	FCP613	LUCAS/TRW
2.0 TDi	72	01/98 → 10/00	FCP613	LUCAS/TRW

Range Rover III (LM)

3.0 Td 6	130	03/02 →			FCP1483	ATE
4.2 Supercharged	291	05/05 →	FCP1334	BREMBO		
4.4	210	03/02 →			FCP1483	ATE
4.4 D 4x4	230	07/10 → 08/12	FCP4379	Brembo		
5.0 V8	375	09/09 → 08/12	FCP4379	Brembo		

Range Rover IV (LG)

3.0 4x4	250	10/13 →	FCP4379	Brembo		
3.0 4x4	280	06/15 →	FCP4379	Brembo		
3.0 D 4x4	155	10/13 →	FCP4379	Brembo		
3.0 D 4x4	183	08/12 →	FCP4379	Brembo		
3.0 D 4x4	190	08/12 →	FCP4379	Brembo		
3.0 D Hybrid 4x4	215	06/15 →	FCP4379	Brembo		
3.0 D Hybrid 4x4	225	06/15 →	FCP4379	Brembo		
3.0 D Hybrid 4x4	250	10/13 →	FCP4379	Brembo		
4.4 D V8 4x4	250	08/12 →	FCP4379	Brembo		
5.0 4x4	276	12/13 →	FCP4379	Brembo		
5.0 4x4	375	08/12 →	FCP4379	Brembo		
5.0 4x4	405	06/15 →	FCP4379	Brembo		

Range Rover Sport (LS)

4.2 Supercharged	291	02/05 →	FCP1334	BREMBO		
5.0 4x4	372	04/09 → 03/13	FCP4379	Brembo		
5.0 4x4	375	09/09 → 03/13	FCP4379	Brembo		

Range Rover Sport (LW)

3.0 D 4x4	155	04/13 →	FCP4379	Brembo		
3.0 D 4x4	183	04/13 →	FCP4379	Brembo		
3.0 D 4x4	225	09/14 →	FCP4379	Brembo		
3.0 D Hybrid 4x4	215	02/15 →	FCP4379	Brembo		
3.0 D Hybrid 4x4	225	06/15 →	FCP4379	Brembo		
3.0 D Hybrid 4x4	250	10/13 →	FCP4379	Brembo		
4.4 D 4x4	250	10/13 →	FCP4379	Brembo		
5.0 4x4	375	04/13 →	FCP4379	Brembo		
5.0 4x4	405	09/14 →	FCP4379	Brembo		

LEXUS

For material availability see page 16-18 / Per la disponibilità materiali vedere a pagina 16-18



KW



LEXUS

LEXUS

ES 300

3.0 01/98 → 12/00 FCP1437 AKEBONO

GX (URJ15_)

460 218 11/09 → FCP1456 SUMITOMO
 460 218 11/09 → FCP1698 SUMITOMO
 460 218 11/09 → FCP1021 SUMITOMO
 460 225 01/10 → FCP1698 SUMITOMO

GX (_J12_)

470 175 11/01 → 11/09 FCP1698 SUMITOMO
 470 175 11/01 → 11/09 FCP1021 SUMITOMO
 470 199 11/01 → 11/09 FCP1698 SUMITOMO
 470 199 11/01 → 11/09 FCP1021 SUMITOMO

IS II

IS F (USE20) 11/07 → FRP3100 BREMBO

LX (FZJ80)

450 4WD Wagon 01/96 → 12/97 FCP1456
 450 4WD Wagon 01/96 → 12/97 FCP1457

LX (URJ201)

570 270 11/07 → FCP1698 SUMITOMO

LX (UZJ100)

470 170 05/98 → 03/08 FCP1456 SUMITOMO
 470 170 05/98 → 03/08 FCP1457 SUMITOMO
 470 173 09/01 → 03/08 FCP1456 SUMITOMO
 470 173 09/01 → 03/08 FCP1457 SUMITOMO
 470 197 05/98 → 10/02 FCP1456 SUMITOMO
 470 202 08/02 → 03/08 FCP1456 SUMITOMO
 470 202 08/02 → 03/08 FCP1457 SUMITOMO

NX (_Z1_)

200t (ZGZ10_) 175 07/14 → FCP4354 ADVICS
 200t AWD (ZGZ15_) 175 07/14 → FCP4354 ADVICS

RX (_L1_)

270 (AGL10_) 138 12/08 → 10/15 FCP4354 ADVICS
 350 AWD (GGL15_, GRL10) 204 12/08 → 02/12 FCP4354 ADVICS
 450h (GYL10_) 183 12/08 → 10/15 FCP4354 ADVICS
 450h AWD (GYL15_) 183 12/08 → 10/15 FCP4354 ADVICS

RX 300

3.0 01/98 → 12/01 FCP1437 AKEBONO

LOTUS

23

1.3 01/62 → 12/66 FRP5002
 1.3 01/62 → 12/66 FRP5002

Eclat

2.2 520,521,522,523 16V 118 01/75 → 12/82 FCP167 LUCAS/TRW

Elan

1.6 S2, 3, 4 16V 01/66 → 12/70 FCP809 LUCAS/TRW Servo
 1.6 Sprint 16V 01/71 → 12/74 FCP809 LUCAS/TRW
 1.6 SS, 130 16V 01/72 → 12/75 FCP167 LUCAS/TRW

Elise

1.8 01/96 → FCP1562 BREMBO
 1.8 01/96 → FCP1560 BREMBO
 1.8 VVC 01/99 → FCP1562 BREMBO
 1.8 VVC 01/99 → FCP1560 BREMBO

Elite

2.2 16V 118 01/73 → 12/82 FCP9 LUCAS/TRW

For material availability see page 16-18 / Per la disponibilità materiali vedere a pagina 16-18

1116

FERODO

RACING

Updated on 17th Aug 2018



KW



...LOTUS

					NOTE			NOTE
Esprit								
2.2 S1, S2, S3 (Turbo) 16V	01/75 → 12/86		FCP116	ATE				
Evora								
3.5	206 05/09 →		FRP3083	AP RACING				
3.5	206 05/09 →					FRP3115	AP RACING	
3.5S	257 12/10 →		FRP3083	AP RACING				
3.5S	257 12/10 →					FRP3115	AP RACING	
Excel								
2.2 16V	118, 135 01/83 → 12/87		FCP9	LUCAS/TRW				
EXIGE (SCC_)								
1.8 Cup 240	181 04/06 → 06/12		FRP3085	AP RACING	4 pistons calipers			
1.8 Cup 240	181 04/06 → 06/12		FRP3056	ATE	2 pistons caliper			
1.8 Cup 240	181 04/06 → 06/12					FCP1560	BREMBO	
Seven / Super Seven								
Third & Fourth generation	01/68 → 12/74		FCP809	LUCAS/TRW				

MASERATI

222								
2.8	01/88 → 12/89		FCP399	ATE				
2.8	01/88 → 12/89					FCP2	ATE	
2.8	01/89 → 10/90		FCP256	ATE				
2.8	01/89 → 10/90					FCP2	ATE	
228								
2.8	01/82 → 12/89		FCP399	ATE				
2.8	01/82 → 12/89					FCP2	ATE	
2.8 18V	165 01/89 → 06/93		FCP256	ATE				
2.8 18V	165 01/89 → 06/93					FCP2	ATE	
3200 GT								
3.2 Biturbo V8 32V	271 10/98 → 03/02		FCP1298	BREMBO				
3.2 Biturbo V8 32V	271 10/98 → 03/02					FCP451	ATE	
420								
2.0	165 01/85 → 12/89		FCP399	ATE				
2.0	165 01/85 → 12/89					FCP2	ATE	
422								
2.2	01/89 →		FCP256	ATE				
2.2	01/89 →					FCP2	ATE	
2.2	165 01/85 → 12/89		FCP399	ATE				
2.2	165 01/85 → 12/89					FCP2	ATE	
425								
2.5	01/85 → 12/89		FCP399	ATE				
2.5	01/85 → 12/89					FCP2	ATE	
430								
2.8	01/89 → 12/94		FCP256	ATE				
2.8	01/89 → 12/94					FCP2	ATE	
2.8 18V	185 01/82 → 12/89		FCP399	ATE				
2.8 18V	185 01/82 → 12/89					FCP2	ATE	
Biturbo								
2.0	161 01/82 → 12/88		FCP399	ATE				
2.0	161 01/82 → 12/88					FCP2	ATE	
2.0	161 01/94 →		FCP856	ATE				
2.0	161 01/94 →					FCP857	ATE	
2.5	130 01/82 → 12/88		FCP399	ATE				
2.5	130 01/82 → 12/88					FCP2	ATE	
2.5	130 01/94 →		FCP856	ATE				
2.5	130 01/94 →					FCP857	ATE	
2.5	147 01/82 → 12/88		FCP399	ATE				
2.5	147 01/82 → 12/88					FCP2	ATE	
2.5	147 01/94 →		FCP856	ATE				
2.5	147 01/94 →					FCP857	ATE	
2.8	185 01/82 → 12/88		FCP399	ATE				
2.8	185 01/82 → 12/88					FCP2	ATE	
2.8	185 01/94 → 12/96		FCP856	ATE				

MASERATI

For material availability see page 16-18 / Per la disponibilità materiali vedere a pagina 16-18



KW

**...MASERATI****...Biturbo**

2.8 185 01/94 → 12/96

NOTE

NOTE

FCP857

ATE

Ghibli

2.0 24V 225 01/89 →

FCP256 ATE

FCP2

ATE

2.0 24V 225 01/89 →

2.8 24V 209 01/89 →

FCP256 ATE

FCP2

ATE

2.8 24V 209 01/89 →

Ghibli (M157)

3.0 243 08/13 →

FCP1334 BREMBO

3.0 D 184 08/13 →

FCP1334 BREMBO

3.0 D 202 08/13 →

FCP1334 BREMBO

3.0 S 301 08/13 →

FCP1334 BREMBO

3.0 S Q4 301 08/13 →

FCP1334 BREMBO

Gran Turismo

4.2 298 08/08 →

FRP3100 BREMBO

4.2 298 08/08 →

FCP1348

BREMBO

4.7 S 323 08/08 →

FRP3100 BREMBO

4.7 S 323 08/08 →

FCP1348

BREMBO

Karif

2.8 18V 165 01/89 →

FCP256 ATE

FCP2

ATE

2.8 18V 165 01/89 →

Quattroporte V

4.2 295 03/04 →

FCP1334 BREMBO

armoured vehicle-veicolo blindato

4.2 295 03/04 →

FCP1298 BREMBO

standard vehicle-veicolo standard

4.2 295 03/04 →

FCP1562

ATE

4.2 295 01/08 →

FRP3100 BREMBO

4.2 295 01/08 →

FCP1348

BREMBO

4.7 V8 317 01/08 →

FRP3100 BREMBO

4.7 V8 317 01/08 →

FCP1348

BREMBO

Spyder

2.8 18V 165 01/89 →

FCP256 ATE

FCP2

ATE

2.8 18V 165 01/89 →

Spyder Coupe'

4.2 287 03/02 →

FCP1298 BREMBO

4.2 287 03/02 →

FCP451

ATE

MATRA**Bagheera**

All Models 01/73 → 09/78

FCP2 ATE

All Models 01/73 → 09/78

FCP72

BENDIX

MAZDA**121**

1.25 i 16V 55 01/96 →

FCP1082 ATE

Solid

1.25 i 16V 55 01/96 →

FCP1081 ATE

Vented

1.3 (DB) 16V 39, 54 04/93 → 10/95

FCP487 SUMITOMO

1.3 DB B3 40 02/91 → 01/93

FCP487 SUMITOMO

1.3 i 37, 44 01/96 →

FCP1082 ATE

Solid

1.3 i 37, 44 01/96 →

FCP1081 ATE

Vented

1.8 D (BAJ) (EU) 44 01/96 →

FCP1082 ATE

Solid

1.8 D (BAJ) (EU) 44 01/96 →

FCP1081 ATE

Vented

2

1.3 16V 55 07/07 →

FCP4426 LUCAS/TRW

1.3 16V 55 06/09 →

FCP4426 LUCAS/TRW

1.3 16V 63 07/07 →

FCP4426 LUCAS/TRW

1.4 8V 50 10/07 →

FCP4426 LUCAS/TRW

1.4 i 16V 04/03 →

FCP1394 ATE

1.5 16V 76 07/07 →

FCP4426 LUCAS/TRW

1.5 16V 83 07/07 →

FCP4426 LUCAS/TRW

1.6 16V 66 10/08 →

FCP4426 LUCAS/TRW

1.6 16V 70 08/10 →

FCP4426 LUCAS/TRW

1.6 i 16V 04/03 →

FCP1394 ATE

For material availability see page 16-18 / Per la disponibilità materiali vedere a pagina 16-18

1118

FERODO

RACING

Updated on 17th Aug 2018

MASERATI



KW



!



!

...MAZDA**3 (BK)**

1.4	62	10/03 → 06/09
1.4	59	02/04 → 06/09
1.6	77	10/03 → 06/09
1.6 DI Turbo	80	06/04 → 06/09
2.0	110	10/03 → 06/09
2.0 MZR-CD	105	12/06 → 06/09
2.3 MPS	191	12/06 → 06/09
2.3 MZR	115	03/04 → 03/09
2.3 MZR Sport	126	10/03 → 06/09

NOTE

NOTE

FCP1931	ATE
FCP1931	ATE
FCP1931	ATE
FCP1931	ATE
FCP1931	ATE
FCP1931	ATE
FCP1931	ATE
FCP1931	ATE
FCP1931	ATE

3 (BL)

1.6 MZR	77	06/09 →
1.6 MZR CD	80	06/09 →
1.6 MZR CD	85	11/10 →
2.0 MZR	110	06/09 →
2.0 MZR DISI	111	06/09 →
2.2 MZR CD	110	06/09 →
2.2 MZR CD	136	06/09 →
2.3 MPS Turbo	191	06/09 →
2.3 MPS Turbo	191	06/09 →

FCP1931	ATE
FCP1931	ATE
FCP1931	ATE
FCP1931	ATE
FCP1931	ATE
FCP1931	ATE
FCP1931	ATE
FCP1706	ATE
FCP1931	ATE

3 Saloon (BK)

1.6	77	02/04 →
1.6 DI Turbo	80	06/04 →
2.0	104	04/04 → 06/06
2.0	110	02/04 →
2.0 MZR-CD	105	12/06 →
2.3	118	03/04 → 03/09
2.3	126	06/00 → 03/03

FCP1931	ATE
FCP1931	ATE
FCP1931	ATE
FCP1931	ATE
FCP1931	ATE
FCP1931	ATE
FCP1931	ATE

3 Saloon (BL)

1.6 MZR	77	06/09 →
1.6 MZR CD	85	11/10 →
2.0 MZR	110	06/09 →
2.0 MZR DISI	111	06/09 →
2.2 MZR CD	110	06/09 →
2.2 MZR CD	136	06/09 →

FCP1931	ATE
FCP1931	ATE
FCP1931	ATE
FCP1931	ATE
FCP1931	ATE
FCP1931	ATE

323

1.1		01/89 →	FCP487	SUMITOMO
1.1 BF1 E1		07/87 → 08/89	FCP487	SUMITOMO
1.3 BA1 16V	55	05/94 → 08/98	FCP487	SUMITOMO
1.3 BF B3		01/87 → 01/90	FCP487	SUMITOMO
1.3 BG B3	49	10/89 → 04/91	FCP487	SUMITOMO
1.3 BG B3 16V	49	05/91 → 01/93	FCP487	SUMITOMO
1.3 SW Estate	54	01/86 → 06/87	FCP487	SUMITOMO
1.5 BA 16V	65	01/94 → 08/98	FCP487	SUMITOMO
1.5 BG SW Estate		01/90 → 05/91	FCP487	SUMITOMO
1.5 BW E5, BW B5 + SW Estate	54, 55	01/85 → 04/91	FCP487	SUMITOMO
1.6 BF B6	63, 77	01/83 → 09/89	FCP487	SUMITOMO
1.6 BG B6		10/89 → 12/91	FCP487	SUMITOMO
1.6 BG B6 16V		05/91 → 10/94	FCP487	SUMITOMO
1.7 D BF	40, 43	07/87 → 08/90	FCP487	SUMITOMO
1.7 D BF SW Estate L		01/86 → 07/91	FCP487	SUMITOMO
1.7 D BF SW Estate LX, GLX		01/87 → 08/91	FCP487	SUMITOMO
1.7 D BF, BG		01/86 → 08/89	FCP487	SUMITOMO
1.7 D BF, BG		09/89 → 03/91	FCP487	SUMITOMO
1.8 BG 16V		10/89 → 10/94	FCP487	SUMITOMO
1.8 BG GT,4WD,Turbo 16V		10/89 → 10/94	FCP487	SUMITOMO
1.8 Turbo 4WD 16V	122	10/89 → 12/92	FCP487	SUMITOMO

323 F V (BA)

2.0 24V	144	08/94 → 09/98	FCP653	SUMITOMO
---------	-----	---------------	--------	----------

5 (CR19)

1.8	85	03/05 →
2.0	107	03/05 →
2.0 CD	105	06/05 →
2.0 CD	81	03/05 →

FCP1931	ATE
FCP1931	ATE
FCP1931	ATE
FCP1931	ATE

5 (CW)

1.6 CD	85	09/10 →
2.0	106	01/11 →
2.0	110	09/10 →

FCP1931	ATE
FCP1931	ATE
FCP1931	ATE

MAZDA

For material availability see page 16-18 / Per la disponibilità materiali vedere a pagina 16-18



KW



MAZDA

...MAZDA					NOTE			NOTE
E1300								
1.3 i		01/81 → 08/83	FCP170	SUMITOMO				
E1400								
1.4 i		01/81 → 08/83	FCP170	SUMITOMO				
E1600								
1.6	52, 54	01/83 → 12/84	FCP170	SUMITOMO				
1.6 i BA2N9		01/81 → 08/83	FCP170	SUMITOMO				
Miata								
1.6		01/89 → 12/93	FCP653	SUMITOMO				
1.8		01/94 → 01/03			FCP1012	SUMITOMO		
MX-3								
1.6 Coupe (EC13) 16V	66, 81	09/91 → 10/93	FCP487	SUMITOMO				
1.6 Coupe V6 (EC13) 16V	65	09/91 → 10/93	FCP487	SUMITOMO				
MX-5 I								
1.8 i (NA) 16V	96	02/94 → 04/98	FCP1011	SUMITOMO				
1.8 i (NA) 16V	96	02/94 → 04/98			FCP1012	SUMITOMO		
MX-5 I (NA)								
1.6	66	01/95 → 04/98	FCP1011	SUMITOMO	(+) ABS			
1.6	66	01/95 → 04/98	FCP653	SUMITOMO	(+) ABS			
1.6	85	05/90 → 01/94	FCP653	SUMITOMO	(+) ABS			
1.6	85	05/90 → 01/94	FCP1011	SUMITOMO	(+) ABS			
MX-5 II								
1.6 i (NB) 16V	81	05/98 → 12/00	FCP1011	SUMITOMO				
1.6 i (NB) 16V	81	05/98 → 12/00			FCP1012	SUMITOMO		
1.6 i (NB) 16V	81	01/01 → 10/05	FCP1011	SUMITOMO				
1.8 i (NB) 16V	103	05/98 → 07/00	FCP1011	SUMITOMO				
1.8 i (NB) 16V	103	05/98 → 07/00			FCP1012	SUMITOMO		
1.8 i (NB) 16V	107	11/00 → 10/05			FCP1012	SUMITOMO		
MX-5 III								
(NC) 1.8	93	03/05 →			FCP1894	SUMITOMO		
(NC) 2.0	118	09/08 →			FCP1894	SUMITOMO		
MX-5 IV								
(ND) 1.5	96	06/15 →	FCP4821	BREMBO				
(ND) 1.5	96	06/15 →	FCP4873	Advics				
(ND) 1.5	96	06/15 →			FCP1894	SUMITOMO		
(ND) 2.0	118	06/15 →	FCP4821	BREMBO				
(ND) 2.0	118	06/15 →	FCP4873	Advics				
(ND) 2.0	118	06/15 →			FCP1894	SUMITOMO		
RX 7 III (FD)								
1.3 Twin Turbo	176	07/92 → 08/02	FCP483	AKEBONO				
RX-7								
2.3 i		01/84 → 12/86			FCP372	AKEBONO		
2.4 i		01/86 → 12/92			FCP372	AKEBONO		
2.6 Coupe (Turbo)	177	01/93 → 12/96	FCP483	AKEBONO				
2.6 i		01/93 → 12/96			FCP372	AKEBONO		
RX-7 I (SA)								
1.0	77	05/79 → 05/81	FCP483	AKEBONO				
1.1	83	03/84 → 03/86	FCP483	AKEBONO				
1.1	85	01/81 → 03/84	FCP483	AKEBONO				
RX-7 II (FC)								
1.3	110	11/85 → 04/89	FCP483	AKEBONO				
1.3 Turbo	133	06/87 → 11/89	FCP483	AKEBONO				
1.3 Turbo	147	03/89 → 12/91	FCP483	AKEBONO				
RX-7 II Convertible								
1.3 Turbo	147	03/89 → 12/91	FCP483	AKEBONO				

For material availability see page 16-18 / Per la disponibilità materiali vedere a pagina 16-18

1120

FERODO

RACING

Updated on 17th Aug 2018



KW



MCLAREN					NOTE			NOTE
570 GT								
3.8	419	06/16 →	FRP3084	AP RACING				
3.8	419	06/16 →				FRP3083	AP RACING	
570 S								
3.8	419	04/15 →	FRP3084	AP RACING				
3.8	419	04/15 →				FRP3083	AP RACING	
650 LT								
Coupe 3.8	496	03/15 →	FRP3084	AP RACING				
Coupe 3.8	496	03/15 →				FRP3083	AP RACING	
Spider 3.8	496	08/16 →	FRP3084	AP RACING				
Spider 3.8	496	08/16 →				FRP3083	AP RACING	
650 S								
Coupe 3.8	478	04/14 →	FRP3084	AP RACING				
Coupe 3.8	478	04/14 →				FRP3083	AP RACING	
Spider 3.8	478	04/14 →	FRP3084	AP RACING				
Spider 3.8	478	04/14 →				FRP3083	AP RACING	
MP4								
Coupe 12C	441	04/11 → 04/14	FRP3084	AP RACING				
Coupe 12C	441	04/11 → 04/14				FRP3083	AP RACING	
Coupe 12C	460	10/12 → 04/14	FRP3084	AP RACING				
Coupe 12C	460	10/12 → 04/14				FRP3083	AP RACING	
MP4-12C GT3		01/12 →	FRP3138	AKEBONO				
MP4-12C GT3		01/12 →				FRP3139	AKEBONO	
Spider 12C	460	08/12 → 04/14	FRP3084	AP RACING				
Spider 12C	460	08/12 → 04/14				FRP3083	AP RACING	
MERCEDES								
190 (W108)								
2.5		01/60 → 12/71	FCP11	ATE				
190 (W201)								
1.8	81	09/86 → 12/94	FCP660	LUCAS/TRW				
2.0		01/82 → 12/94	FCP660	LUCAS/TRW				
2.0 D		01/82 → 12/94	FCP660	LUCAS/TRW				
2.3 E 16V	130, 143	01/82 → 12/94	FCP415	BENDIX				
2.3 Not 16V	97	01/82 → 12/94	FCP660	LUCAS/TRW				
2.5 D	69	01/82 → 12/94	FCP660	LUCAS/TRW				
2.5 E 16V	130, 143	01/82 → 12/94	FCP415	BENDIX				
2.5 E 16V	130, 143	01/82 → 12/94	FCP646	ATE				
2.5 TD	93	11/87 → 12/94	FCP660	LUCAS/TRW				
2.6	118	01/82 → 12/94	FCP660	LUCAS/TRW				
200								
2.0 D W124 Saloon	55	03/90 → 05/95	FCP415	BENDIX				
2.0 D W124 SW Estate		03/90 → 05/95	FCP415	BENDIX				
2.0 D W114, 115		01/68 → 12/76	FCP11	ATE				
2.0 D W114, 115		01/68 → 12/76				FCP2	ATE	
2.0 D W124 Saloon/SW Estate	55	01/85 → 05/95	FCP415	BENDIX				
2.0 E W124 Saloon/SW Estate	77	01/85 → 05/95	FCP415	BENDIX				
2.0 E W124 Saloon/SW Estate	80	01/85 → 05/95	FCP415	BENDIX				
2.0 E W124 Saloon/SW Estate	87	01/85 → 05/95	FCP415	BENDIX				
2.0 i W124 E Saloon	77, 87	03/90 → 05/95	FCP415	BENDIX				
2.0 i W124 E SW Estate		03/90 → 05/95	FCP415	BENDIX				
2.0 i W124 Saloon	77	03/90 → 05/95	FCP415	BENDIX				
2.0 i W124 Saloon	80	03/90 → 05/95	FCP415	BENDIX				
2.0 i W124 Saloon	87	03/90 → 05/95	FCP415	BENDIX				
2.0 i W124 SW Estate		03/90 → 05/95	FCP415	BENDIX				
2.0 W114, 115	63	01/68 → 12/76	FCP11	ATE				
2.0 W114, 115	63	01/68 → 12/76				FCP2	ATE	
2.0 W124 Saloon/SW Estate	77	01/85 → 05/95	FCP415	BENDIX				
2.0 W124 Saloon/SW Estate	80	01/85 → 05/95	FCP415	BENDIX				
2.0 W124 Saloon/SW Estate	87	01/85 → 05/95	FCP415	BENDIX				
200 (W110)								
2.0 D		01/71 → 07/73	FCP11	ATE				

MERCEDES

For material availability see page 16-18 / Per la disponibilità materiali vedere a pagina 16-18



KW



...MERCEDES

220

2.2 C W124 Coupe	01/87 → 05/93	FCP415	BENDIX
2.2 C W124 Saloon/SW Estate	01/85 → 05/95	FCP415	BENDIX
2.2 D W110	01/71 → 07/73	FCP11	ATE
2.2 D W114, 115	44 01/68 → 12/76	FCP11	ATE
2.2 D W114, 115	44 01/68 → 12/76		
2.2 E W124 Coupe	01/87 → 05/93	FCP415	BENDIX
2.2 E W124 Saloon/SW Estate	01/85 → 05/95	FCP415	BENDIX
2.2 i W124 Saloon	03/90 → 05/95	FCP415	BENDIX
2.2 i W124 SW Estate	03/90 → 05/95	FCP415	BENDIX

230

2.3 C W124 Coupe	01/87 → 08/88	FCP415	BENDIX
2.3 C W124 Saloon/SW Estate	01/85 → 06/93	FCP415	BENDIX
2.3 E W124 Coupe	01/87 → 08/89	FCP415	BENDIX
2.3 E W124 Saloon/SW Estate	97 01/85 → 06/93	FCP415	BENDIX
2.3 W114, 115	01/68 → 12/73	FCP11	ATE
2.3 W114, 115	01/68 → 12/73		

234

All i W114, 115	01/68 → 12/73	FCP11	ATE
All i W114, 115	01/68 → 12/73		
W114, 115	01/68 → 12/73	FCP11	ATE
W114, 115	01/68 → 12/73		

250

2.5 D W124 Saloon	66 03/90 → 05/95	FCP415	BENDIX
2.5 D W124 SW Estate	03/90 → 05/95	FCP415	BENDIX
2.5 D W124 Saloon/SW Estate	66 01/85 → 05/95	FCP415	BENDIX
2.5 TD W124 Saloon	93 01/85 → 02/90	FCP415	BENDIX

260

2.6 E W124 Saloon/SW Estate	118 01/85 → 06/93	FCP415	BENDIX
-----------------------------	-------------------	--------	--------

280

2.8 E W124 Saloon/SW Estate	125 01/85 → 05/95	FCP415	BENDIX
2.8 i W124 E Saloon	03/90 → 05/95	FCP415	BENDIX
2.8 i W124 E SW Estate	03/90 → 05/95	FCP415	BENDIX

300

3.0 C W124 Coupe	132 01/87 → 08/88	FCP415	BENDIX
3.0 C W124 Coupe 24V	162 01/89 → 12/93	FCP646	ATE
3.0 C W124 Saloon 24V	162 01/89 → 06/93	FCP646	ATE
3.0 C W124 Saloon/SW Estate	132 01/85 → 05/95	FCP415	BENDIX
3.0 D W124 Saloon	80 03/90 → 05/95	FCP415	BENDIX
3.0 D W124 SW Estate	03/90 → 05/95	FCP415	BENDIX
3.0 D W124 Coupe	80 01/87 → 08/88	FCP415	BENDIX
3.0 D W124 Coupe 24V	162 01/89 → 12/93	FCP646	ATE
3.0 D W124 Saloon/SW Estate	80 01/85 → 05/95	FCP415	BENDIX
3.0 E W124 Coupe	132 01/87 → 08/88	FCP415	BENDIX
3.0 E W124 Coupe 24V	162 01/89 → 12/93	FCP646	ATE
3.0 E W124 Saloon 24V	162 01/89 → 06/93	FCP646	ATE
3.0 E W124 Saloon/SW Estate	132 01/85 → 05/95	FCP415	BENDIX
3.0 i W124 C Saloon	03/90 → 05/95	FCP415	BENDIX
3.0 i W124 C SW Estate	03/90 → 05/95	FCP415	BENDIX
3.0 i W124 E Saloon	132 03/90 → 05/95	FCP415	BENDIX
3.0 i W124 E SW Estate	03/90 → 05/95	FCP415	BENDIX

300 (W115)

3.0	01/60 → 12/71	FCP11	ATE
-----	---------------	-------	-----

320

3.2 E W124 Coupe	01/89 →	FCP646	ATE
3.2 E W124 Saloon, SW Estate	01/91 → 05/95	FCP646	ATE
3.2 i W124 E Coupe	10/92 → 05/93	FCP646	ATE

400

4.2 E W124 Saloon 32V	205 01/91 → 06/93	FCP646	ATE
-----------------------	-------------------	--------	-----

420

4.2 E W124 Saloon	07/93 → 05/95	FCP646	ATE
-------------------	---------------	--------	-----

For material availability see page 16-18 / Per la disponibilità materiali vedere a pagina 16-18

1122

FERODO

RACING

Updated on 17th Aug 2018

MERCEDES



KW



...MERCEDES

500

5.0 E W124 Saloon		07/93 → 05/95	FCP646	ATE				
5.0 E W124 Saloon 32V	235	01/91 → 06/93	FCP646	ATE				

A-CLASS (W176)

A 45 AMG 4-matic (176.052)	265	06/13 → 06/15	FCP4806	BREMBO				
A 45 AMG 4-matic (176.052)	265	06/13 → 06/15			FCP4587	LUCAS/TRW		
AMG A 45 4-matic (176.052)	280	07/15 →	FCP4806	BREMBO				
AMG A 45 4-matic (176.052)	280	07/15 →			FCP4587	LUCAS/TRW		

A190

1.9 (W168)	92	11/97 → 02/99			FCP541	LUCAS/TRW		
------------	----	---------------	--	--	--------	-----------	--	--

C-CLASS (S203)

3.0 20v C30 CDI AMG	170	08/02 → 12/04	FCP1661	BREMBO				
---------------------	-----	---------------	---------	--------	--	--	--	--

C-CLASS (W203)

1.8 16v with sports package	105	05/02 → 04/04	FCP1661	BREMBO				
1.8 16v with sports package	120	05/02 → 04/04	FCP1661	BREMBO				
1.8 16v with sports package	141	11/03 → 04/04	FCP1661	BREMBO				
1.8 CGI 16v with sports package	125	07/03 → 04/04	FCP1661	BREMBO				
2.2 CDI 16v with sports package	85	06/00 → 03/04	FCP1661	BREMBO				
2.2 CDI 16v with sports package	90	04/03 → 04/04	FCP1661	BREMBO				
2.2 CDI 16v with sports package	105	06/00 → 12/04	FCP1661	BREMBO				
2.2 CDI 16v with sports package	110	04/03 → 04/04	FCP1661	BREMBO				
2.2 CDI 16v with sports package	75	02/01 → 03/04	FCP1661	BREMBO				
2.6 18v with sports package	125	06/00 → 04/04	FCP1661	BREMBO				
2.7 CDI 20v with sports package	125	06/00 → 04/04	FCP1661	BREMBO				
3.0 20v C30CDi AMG	170	08/02 → 12/04	FCP1661	BREMBO				
3.0 CDI 24v with sports package	165	01/05 → 02/07	FCP1661	BREMBO				
3.2 18v C32 AMG	260	11/00 → 12/04	FCP1661	BREMBO				
3.2 18v with sports package	160	06/00 → 04/04	FCP1661	BREMBO				
3.5 24v 4-matic C350	200	03/05 → 02/07	FCP1661	BREMBO				
3.5 24v C350 with sports package	200	01/05 → 02/07	FCP1661	BREMBO				
5.4 24v C55 AMG	270	08/03 → 02/07	FCP1661	BREMBO				

C-CLASS (W204)

C63 AMG	336	02/08 →	FRP3133	Brembo				
C63 AMG	358	02/08 →	FRP3133	Brembo				

C-CLASS Coupe (C204)

C63 AMG	336	06/11 →	FRP3133	Brembo				
C63 AMG	358	01/12 →	FRP3133	Brembo				
C63 AMG	380	01/12 →	FRP3133	Brembo				

C-CLASS Coupe (CL203)

3.0 20v CDi AMG	170	08/02 → 01/08	FCP1661	BREMBO				
3.2 18v	160	06/02 → 08/05	FCP1661	BREMBO				

C-CLASS Estate (S204)

C63 AMG	336	02/08 →	FRP3133	Brembo				
C63 AMG	358	01/12 →	FRP3133	Brembo				

C-CLASS T-Model (S203)

1.8 16v with sports package	105	05/02 → 04/04	FCP1661	BREMBO				
1.8 16v with sports package	120	05/02 → 04/04	FCP1661	BREMBO				
1.8 16v with sports package	141	11/03 → 04/04	FCP1661	BREMBO				
1.8 CGI 16v with sports package	125	07/03 → 07/04	FCP1661	BREMBO				
2.2 CDI 16v with sports package	105	11/00 → 07/03	FCP1661	BREMBO				
2.2 CDI 16v with sports package	110	08/03 → 04/04	FCP1661	BREMBO				
2.2 CDI 16v with sports package	75	03/01 → 03/03	FCP1661	BREMBO				
2.2 CDI 16v with sports package	85	11/00 → 07/03	FCP1661	BREMBO				
2.2 CDI 16v with sports package	90	04/03 → 04/04	FCP1661	BREMBO				
2.6 18v with sports package	125	11/00 → 04/04	FCP1661	BREMBO				
2.7 CDI 20v with sports package	125	11/00 → 04/04	FCP1661	BREMBO				
3.0 CDI 24v with sports package	165	01/05 → 11/07	FCP1661	BREMBO				
3.2 18v C32 AMG	260	11/00 → 12/04	FCP1661	BREMBO				
3.2 18v with sports package	160	11/00 → 04/04	FCP1661	BREMBO				
3.5 24v C350 with sports package	200	01/05 → 11/07	FCP1661	BREMBO				
3.5 24v C350Å 4-matic	200	04/05 → 11/07	FCP1661	BREMBO				
5.4 24v C55 AMG	270	08/03 → 11/07	FCP1661	BREMBO				

MERCEDES

For material availability see page 16-18 / Per la disponibilità materiali vedere a pagina 16-18



KW

**...MERCEDES****C200**

2.0 i T202 SW Estate Kompressor 16V 100, 141 11/96 → 03/01

FCP1049 ATE

NOTE

2.0 i W202 Kompressor 16V 100, 141 10/95 → 05/00

FCP1049 ATE

NOTE

C230

2.3 (W202) Kompressor 16V 142 10/95 → 05/00

FCP1049 ATE

C240

2.4 (W202) 18V 125 06/97 → 05/00

FCP1049 ATE

C250

2.5 TD T202 SW Estate 20V 110 06/96 → 03/01

FCP1049 ATE

2.5 TD W202 20V 110 10/95 → 05/00

FCP1049 ATE

C280

2.8 (W202) 145 06/97 → 05/00

FCP1049 ATE

C36 AMG

3.6 24V 206 01/95 → 03/97

FCP1049 ATE

3.6 i 24V (W202) 206 07/94 → 05/00

FCP646 ATE

C43 AMG

4.3 24v (S202) 225 04/97 → 05/00

FCP1001 ATE

CL500

5.0 24v (C215) 225 09/99 → 12/06

FCP1661 BREMBO

CL600

5.8 36v (C215) 270 09/99 → 07/02

FCP1661 BREMBO

CLA Coupe (C117)

AMG CLA 45 4-matic (117.352) 280 07/15 →

FCP4806 BREMBO

AMG CLA 45 4-matic (117.352) 280 07/15 →

FCP4587 LUCAS/TRW

CLA 45 AMG 4-matic (117.352) 265 07/13 → 06/15

FCP4806 BREMBO

CLA 45 AMG 4-matic (117.352) 265 07/13 → 06/15

FCP4587 LUCAS/TRW

CLA Shooting Brake (X117)

AMG CLA 45 4-matic (117.952) 280 07/15 →

FCP4806 BREMBO

AMG CLA 45 4-matic (117.952) 280 07/15 →

FCP4587 LUCAS/TRW

CLA 45 AMG 4-matic (117.952) 265 01/15 → 06/15

FCP4806 BREMBO

CLA 45 AMG 4-matic (117.952) 265 01/15 → 06/15

FCP4587 LUCAS/TRW

CLK (C209)

63 AMG 373 05/07 → 05/09

FRP3133 Brembo

CLK 55 AMG (C209)

5.5 (209.376) 270 09/02 → 11/06

FRP3100 BREMBO

6 pistons brake systems

5.5 (209.376) 270 09/02 → 11/06

FCP1661 BREMBO

CLK200

2.0 Coupe (C208) 16V 100, 141 07/97 →

FCP1049 ATE

CLK230

2.3 Coupe (C208) Kompressor 16V 142 07/97 →

FCP1049 ATE

CLK320

3.0 CDI 24v (C209) with sports package 165 03/05 →

FCP1661 BREMBO

3.2 Coupe (C208) 18V 160 07/97 →

FCP1050 ATE

CLK350

3.5 24v (C209) with sports package 200 03/05 →

FCP1661 BREMBO

CLK430 (C208)

4.3 24v 205 08/99 → 01/03

FCP1001 ATE

CLK500

5.0 24v (C209) (209.375) 225 06/02 → 05/09

FCP1661 BREMBO

5.5 32v (C209) (209.372) 285 09/06 → 05/09

FCP1661 BREMBO

For material availability see page 16-18 / Per la disponibilità materiali vedere a pagina 16-18

1124

FERODO

RACING

Updated on 17th Aug 2018

MERCEDES



KW



...MERCEDES

CLK55 AMG

Model	Power	Year	Code	Brand	NOTE
5.4 24v (C208)	255	10/98 → 07/02	FCP1001	ATE	

CLS (C219)

CLS 63 AMG	378	04/06 → 12/10	FRP3133	Brembo	
------------	-----	---------------	---------	--------	--

CLS280

3.0 24v (C219)	170	07/08 →	FCP1661	BREMBO	
----------------	-----	---------	---------	--------	--

CLS300

3.0 24v (C219)	170	04/09 →	FCP1661	BREMBO	
----------------	-----	---------	---------	--------	--

CLS320

3.0 CDI 24v (C219)	165	03/05 →	FCP1661	BREMBO	
--------------------	-----	---------	---------	--------	--

CLS350

3.0 CDI 24v (C219)	165	04/09 →	FCP1661	BREMBO	
--------------------	-----	---------	---------	--------	--

3.5 24v (C219)	200	07/04 → 12/10	FCP1661	BREMBO	
----------------	-----	---------------	---------	--------	--

3.5 CGI 24v (C219)	215	04/06 →	FCP1661	BREMBO	
--------------------	-----	---------	---------	--------	--

CLS500

5.0 24v (C219)	225	07/04 → 03/06	FCP1661	BREMBO	
----------------	-----	---------------	---------	--------	--

E-CLASS (W211)

2.5 24v with sports package	150	05/07 →	FCP1661	BREMBO	
-----------------------------	-----	---------	---------	--------	--

2.5 24v with sports package	150	09/07 →	FCP1661	BREMBO	
-----------------------------	-----	---------	---------	--------	--

3.0 24v 4-matic with sports package	170	03/05 →	FCP1661	BREMBO	
-------------------------------------	-----	---------	---------	--------	--

3.0 24v without sports package	170	06/05 → 08/05	FCP1661	BREMBO	
--------------------------------	-----	---------------	---------	--------	--

3.0 CDI 24v 4-matic with sports package	165	03/05 → 10/05	FCP1001	ATE	
---	-----	---------------	---------	-----	--

3.0 CDI 24v Blue TEC with sports package	155	09/07 → 12/08	FCP1661	BREMBO	
--	-----	---------------	---------	--------	--

3.0 CDI 24v with sports package	165	03/05 →	FCP1661	BREMBO	
---------------------------------	-----	---------	---------	--------	--

3.2 18v	165	04/02 → 09/03	FCP1661	BREMBO	
---------	-----	---------------	---------	--------	--

3.2 CDI 24v For armoured vehicles	130	08/03 → 07/05	FCP1661	BREMBO	
-----------------------------------	-----	---------------	---------	--------	--

3.2 CDI 24v For armoured vehicles	150	11/02 → 07/06	FCP1661	BREMBO	
-----------------------------------	-----	---------------	---------	--------	--

3.5 24v 4-matic with sports package	200	08/04 → 06/05	FCP1001	ATE	To Ch. 870950
-------------------------------------	-----	---------------	---------	-----	---------------

3.5 24v without sports package	200	08/04 → 08/05	FCP1661	BREMBO	
--------------------------------	-----	---------------	---------	--------	--

3.5 24v without sports package	200	08/04 →	FCP1661	BREMBO	
--------------------------------	-----	---------	---------	--------	--

3.5 CGI 24v	215	05/06 →	FCP1661	BREMBO	
-------------	-----	---------	---------	--------	--

4.0 CDI 32v	191	02/03 → 07/05	FCP1661	BREMBO	
-------------	-----	---------------	---------	--------	--

5.0 24v	225	04/02 → 06/05	FCP1661	BREMBO	
---------	-----	---------------	---------	--------	--

5.0 24v 4-matic without sports package	225	08/03 → 07/06	FCP1001	ATE	
--	-----	---------------	---------	-----	--

5.5 32v without sports package	285	05/06 →	FCP1661	BREMBO	
--------------------------------	-----	---------	---------	--------	--

5.5 32v 4-matic without sports package	285	05/06 →	FCP1661	BREMBO	
--	-----	---------	---------	--------	--

E63 AMG	378	03/06 → 12/08	FRP3133	Brembo	
---------	-----	---------------	---------	--------	--

E-CLASS Estate (S211)

E63 AMG	378	03/06 → 07/09	FRP3133	Brembo	
---------	-----	---------------	---------	--------	--

E-CLASS Estate (S212)

E63 AMG	386	02/11 →	FRP3133	Brembo	
---------	-----	---------	---------	--------	--

E-CLASS T-Model (S211)

2.5 24v	150	05/07 →	FCP1661	BREMBO	
---------	-----	---------	---------	--------	--

3.0 24v 4-matic with sports package	170	06/05 → 08/05	FCP1001	ATE	To Ch. 870950
-------------------------------------	-----	---------------	---------	-----	---------------

3.0 24v with sports package	170	03/05 →	FCP1661	BREMBO	
-----------------------------	-----	---------	---------	--------	--

3.0 CDI 24v	165	03/05 →	FCP1661	BREMBO	
-------------	-----	---------	---------	--------	--

3.2 18v	165	04/03 → 07/04	FCP1661	BREMBO	
---------	-----	---------------	---------	--------	--

3.2 CDI 24v	150	04/03 → 07/06	FCP1661	BREMBO	
-------------	-----	---------------	---------	--------	--

3.5 24v	200	08/04 → 07/06	FCP1661	BREMBO	
---------	-----	---------------	---------	--------	--

3.5 24v 4-matic	200	08/04 →	FCP1661	BREMBO	
-----------------	-----	---------	---------	--------	--

3.5 CGI 24v	215	05/06 →	FCP1661	BREMBO	
-------------	-----	---------	---------	--------	--

5.0 24v	225	08/03 → 07/06	FCP1661	BREMBO	
---------	-----	---------------	---------	--------	--

5.0 24v 4-matic	225	08/03 → 08/05	FCP1001	ATE	To Ch. 870950
-----------------	-----	---------------	---------	-----	---------------

5.5 32v 4-matic without sports package	285	05/06 →	FCP1661	BREMBO	
--	-----	---------	---------	--------	--

5.5 32v without sports package	285	05/06 →	FCP1661	BREMBO	
--------------------------------	-----	---------	---------	--------	--

E200

2.0 (W210)		06/95 →	FCP1049	ATE	
------------	--	---------	---------	-----	--

2.0 D (W124)	55	07/93 → 06/95	FCP415	BENDIX	
--------------	----	---------------	--------	--------	--

E200 T-Model (S211)

1.8 16v with sports package	135	04/06 →	FCP1661	BREMBO	
-----------------------------	-----	---------	---------	--------	--

MERCEDES

For material availability see page 16-18 / Per la disponibilità materiali vedere a pagina 16-18



KW

**...MERCEDES****E200 (W211)**

1.8 16v E200 NGT with sports package	120	03/04 →	FCP1661	BREMBO
1.8 16v with sports package	120	08/02 → 07/06	FCP1661	BREMBO
1.8 16v with sports package	135	04/06 →	FCP1661	BREMBO
1.8 CGI 16v with sports package	125	08/02 → 06/05	FCP1661	BREMBO
2.2 CDI 16v with sports package	100	04/06 →	FCP1661	BREMBO
2.2 CDI 16v with sports package	75	11/02 → 07/05	FCP1661	BREMBO
2.2 CDI 16v with sports package	90	07/02 → 07/06	FCP1661	BREMBO

E200 T-Model (S211)

1.8 16v with sports package	120	04/03 → 07/06	FCP1661	BREMBO
-----------------------------	-----	---------------	---------	--------

E220

2.2 (W210) 16V	70	06/95 → 05/98	FCP1049	ATE
2.2 D (W210)		06/95 → 05/98	FCP1049	ATE

E220 (W211)

2.2 CDI 16v with sports package	100	03/02 →	FCP1661	BREMBO
2.2 CDI 16v with sports package	110	04/02 → 07/06	FCP1661	BREMBO
2.2 CDI 16v with sports package	125	11/05 →	FCP1661	BREMBO

E230

2.3 (W210) 16V	110	06/95 → 10/97	FCP1049	ATE
----------------	-----	---------------	---------	-----

E240

2.4 i W210	125	04/97 → 03/02	FCP1049	ATE
2.4 i W210 V6 ESP	125	04/97 → 03/02	FCP1050	ATE

E250

2.5 D (W210) 20V	83	06/95 → 07/99	FCP1049	ATE
------------------	----	---------------	---------	-----

E270

2.7 CDI W210	125	07/99 → 03/02	FCP1049	ATE
2.7 CDI W210 ESP	125	07/99 → 03/02	FCP1050	ATE

E270 T-Model (S211)

2.7 CDI 20v	130	04/03 → 07/05	FCP1661	BREMBO
-------------	-----	---------------	---------	--------

E280

2.8 (W210)	142	06/95 → 11/96	FCP1050	ATE
2.8 (W210) 24V	142	12/96 → 10/97	FCP1050	ATE

E280 (W211)

3.0 CDI 24v with sports package	140	03/05 →	FCP1661	BREMBO
---------------------------------	-----	---------	---------	--------

E280 (W211)

3.0 CDI 24v 4-matic with sports package	140	03/05 → 08/05	FCP1001	ATE	To Ch. 870950
---	-----	---------------	---------	-----	---------------

E280 T-Model (S211)

3.0 CDI 24v	140	03/05 →	FCP1661	BREMBO
3.0 CDI 24v 4-matic without sports package	140	03/05 → 08/05	FCP1661	BREMBO

E290

2.9 TD (T210) SW Estate	95	06/95 →	FCP1049	ATE
2.9 TD (W210)	95	06/95 →	FCP1049	ATE

E300

3.0 D (W210)	100	06/95 → 01/96	FCP1049	ATE
3.0 TD (W210) 24V	130	12/96 → 07/99	FCP1050	ATE

E320

3.2 (W210) 18V	162, 165	06/95 → 12/97	FCP1050	ATE
3.2 CDI T210		01/99 → 03/03	FCP1050	ATE
3.2 CDI W210	145	07/99 → 03/02	FCP1050	ATE
3.2 i W124 E 24V		07/93 → 07/96	FCP646	ATE
3.2 i W210	165	12/97 → 03/02	FCP1050	ATE

E36 AMG

3.6 i (W210)	200	02/96 → 03/02	FCP646	ATE
--------------	-----	---------------	--------	-----

For material availability see page 16-18 / Per la disponibilità materiali vedere a pagina 16-18

1126

FERODO

RACING

Updated on 17th Aug 2018

MERCEDES



KW



...MERCEDES

E360 AMG

3.6 24V 02/96 →

FCP646 ATE

NOTE

NOTE

E420

4.2 (W210) 32V 205 01/96 → 10/97

FCP646 ATE

E430

4.3 i T210 SW Estate 09/97 →

FCP646 ATE

4.3 i W210 09/97 → 03/02

FCP646 ATE

E430 (S210)

4.3 24v 205 09/99 → 05/03

FCP1001 ATE

E50 AMG

5.0 32v (W210) 255 09/96 → 10/97

FCP1001 ATE

E55 AMG

5.4 24v (S210) 260 11/97 → 05/03

FCP1001 ATE

5.4 24v (W210) 260 01/97 → 11/02

FCP1001 ATE

GL-CLASS (X166)

GL 350 CDI / BlueTec 4-matic (166.823, 166.824) 190 07/12 →

FCP4587 LUCAS/TRW

GL 350 CDI / BlueTEC 4-matic (166.824) 179 07/12 →

FCP4587 LUCAS/TRW

GL 400 4-matic (166.856) 245 08/13 →

FCP4587 LUCAS/TRW

GL 450 4-matic 270 09/14 →

FCP4587 LUCAS/TRW

GL 450 4-matic (166.872) 270 07/12 →

FCP4587 LUCAS/TRW

GL 500 4-matic (166.871) 310 04/15 →

FCP4587 LUCAS/TRW

GL 500 4-matic (166.873) 320 07/12 →

FCP4587 LUCAS/TRW

GL 63 AMG 4-matic (166.874) 410 07/12 →

FRP3133 Brembo

FCP4587 LUCAS/TRW

GL 63 AMG 4-matic (166.874) 410 07/12 →

FCP4587 LUCAS/TRW

GLA-CLASS (X156)

AMG GLA 45 4-matic (156.952) 280 07/15 →

FCP4806 BREMBO

FCP4587 LUCAS/TRW

AMG GLA 45 4-matic (156.952) 280 07/15 →

FCP4587 LUCAS/TRW

GLA 45 AMG 4-matic (156.952) 265 05/14 → 06/15

FCP4806 BREMBO

FCP4587 LUCAS/TRW

GLA 45 AMG 4-matic (156.952) 265 05/14 → 06/15

FCP4587 LUCAS/TRW

GLE (W166)

250 d (166.006) 150 04/15 →

FCP4587 LUCAS/TRW

250 d 4-matic (166.004) 150 04/15 →

FCP4587 LUCAS/TRW

320 4-matic (166.062) 200 10/15 →

FCP4587 LUCAS/TRW

350 (166.058) 225 11/15 →

FCP4587 LUCAS/TRW

350 4-matic (166.057) 225 11/15 →

FCP4587 LUCAS/TRW

350 d 4-matic (166.024) 190 04/15 →

FCP4587 LUCAS/TRW

400 4-matic (166.056) 245 04/15 →

FCP4587 LUCAS/TRW

450 AMG 4-matic (166.064) 270 10/15 → 04/16

FCP4587 LUCAS/TRW

500 4-matic (166.073) 300 04/15 →

FCP4587 LUCAS/TRW

500 4-matic (166.073) 320 04/15 →

FCP4587 LUCAS/TRW

500 4-matic (166.073) 335 10/15 →

FCP4587 LUCAS/TRW

500 e 4-matic (166.063) 245 04/15 →

FCP4587 LUCAS/TRW

500 e 4-matic (166.063) 325 04/15 →

FCP4587 LUCAS/TRW

AMG 43 4-matic (166.064) 270 05/16 →

FCP4587 LUCAS/TRW

AMG 63 4-matic (166.074) 386 04/15 →

FCP4587 LUCAS/TRW

AMG 63 4-matic (166.074) 410 04/15 →

FCP4587 LUCAS/TRW

AMG 63 S 4-matic (166.075) 430 04/15 →

FCP4587 LUCAS/TRW

GLE Coupe (C292)

320 4-matic (292.362) 200 09/15 →

FCP4587 LUCAS/TRW

350 d 4-matic (292.323, 292.324) 190 03/15 →

FCP4587 LUCAS/TRW

350 d 4-matic (292.324) 179 03/16 →

FCP4587 LUCAS/TRW

400 4-matic (292.356) 245 03/15 →

FCP4587 LUCAS/TRW

450 AMG 4-matic (292.364) 270 03/15 → 04/16

FCP4587 LUCAS/TRW

500 4-matic (292.373) 335 10/15 →

FCP4587 LUCAS/TRW

AMG 43 4-matic (292.364) 270 05/16 →

FCP4587 LUCAS/TRW

GLS (X166)

350 d 4-matic (166.824) 190 11/15 →

FCP4587 LUCAS/TRW

400 4-matic (166.856) 245 11/15 →

FCP4587 LUCAS/TRW

450 4-matic (166.864) 270 06/16 →

FCP4587 LUCAS/TRW

500 4-matic (166.871) 310 03/16 →

FCP4587 LUCAS/TRW

500 4-matic (166.873) 335 11/15 →

FCP4587 LUCAS/TRW

For material availability see page 16-18 / Per la disponibilità materiali vedere a pagina 16-18



KW

**...MERCEDES****M-CLASS (W163)**

2.7 CDI 20v	120	09/00 → 07/05	FCP1661	BREMBO
3.2 18v	160	09/00 → 08/02	FCP1661	BREMBO
3.7 18v	173	04/03 → 07/05	FCP1661	BREMBO
3.7 18v	180	08/02 → 07/03	FCP1661	BREMBO
4.0 CDI 32v	184	09/01 → 07/05	FCP1661	BREMBO
4.3 24v	200	09/00 → 08/02	FCP1661	BREMBO
5.0 24v	215	09/01 → 07/05	FCP1661	BREMBO

M-CLASS (W164)

ML 63 AMG 4-matic (164.177)	375	01/06 → 12/11		
-----------------------------	-----	---------------	--	--

M-CLASS (W166)

ML 250 CDI / BlueTEC 4-matic (166.004, 166.003)	150	06/11 →		
ML 300 4-matic (166.055)	185	04/14 →		
ML 320 4-matic (166.062)	200	11/13 →		
ML 350 (166.058)	225	09/11 →		
ML 350 4-matic (166.057)	225	06/11 →		
ML 350 BlueTEC 4-matic (166.024)	190	06/11 →		
ML 350 CDI 4-matic	179	09/12 →		
ML 350 CDI 4-matic (166.023)	170	06/11 →		
ML 400 4-matic (166.056)	245	08/13 →		
ML 500 4-matic (166.073)	300	02/12 →		
ML 63 AMG 4-matic (166.074)	386	11/11 →	FRP3133	Brembo
ML 63 AMG 4-matic (166.074)	386	11/11 →		
ML 63 AMG 4-matic (166.074)	410	11/11 →	FRP3133	Brembo
ML 63 AMG 4-matic (166.074)	410	11/11 →		

ML55 AMG

5.4 24v (W163)	255	06/99 → 07/05	FCP1661	BREMBO
----------------	-----	---------------	---------	--------

R-CLASS (W251, V251)

R 63 AMG 4-matic (251.077, 251.177)	375	02/06 →		
-------------------------------------	-----	---------	--	--

S-CLASS (W220)

2.8 18v	150	10/02 → 08/05	FCP1661	BREMBO
3.2 CDI 24v	150	09/02 → 08/05	FCP1661	BREMBO
3.7 18v	180	09/02 → 08/05	FCP1661	BREMBO
4.0 CDI 32v	184	07/00 → 08/05	FCP1661	BREMBO
4.0 CDI 32v	184	10/02 → 08/05	FCP1661	BREMBO
4.0 CDI 32v	191	08/03 → 08/05	FCP1661	BREMBO
4.3 24v	205	10/02 → 08/05	FCP1661	BREMBO
5.0 24v	225	01/02 → 08/05	FCP1661	BREMBO

S-CLASS (W221)

S 63 AMG (221.074, 221.174)	400	03/11 → 12/13	FCP4412	ATE
S 63 AMG (221.074, 221.174)	400	03/11 → 12/13		
S 63 AMG (221.074, 221.174)	420	02/12 → 12/13	FCP4412	ATE
S 63 AMG (221.074, 221.174)	420	02/12 → 12/13		
S 63 AMG (221.077, 221.177)	386	10/06 → 12/13	FCP4412	ATE
S 63 AMG (221.077, 221.177)	386	10/06 → 12/13		
S 65 AMG (221.179)	450	12/05 → 12/13	FCP4412	ATE
S 65 AMG (221.179)	450	12/05 → 12/13		
S 65 AMG (221.179)	463	04/11 → 12/13	FCP4412	ATE
S 65 AMG (221.179)	463	04/11 → 12/13		

S-CLASS 4-matic

4.3 24v	205	09/02 → 08/05	FCP1001	ATE
5.0 24v	225	09/02 → 08/05	FCP1001	ATE

S-CLASS Coupe (C215)

5.0 24v CL 500	225	01/02 → 08/05	FCP1661	BREMBO
5.4 24v CL55 AMG	265	04/00 → 07/02	FCP1661	BREMBO

S-CLASS Coupe (C216)

CL 600	380	05/06 →	FRP3133	Brembo
CL 63 AMG (216.374)	400	02/11 → 12/13	FCP4412	ATE
CL 63 AMG (216.374)	400	02/11 → 12/13		
CL 63 AMG (216.374)	420	01/10 → 12/13	FCP4412	ATE
CL 63 AMG (216.374)	420	01/10 → 12/13		
CL 63 AMG (216.377)	386	10/06 → 12/13	FCP4412	ATE
CL 63 AMG (216.377)	386	10/06 → 12/13		
CL 65 AMG (216.379)	450	10/06 → 12/10	FCP4412	ATE
CL 65 AMG (216.379)	450	10/06 → 12/10		
CL 65 AMG (216.379)	463	02/11 → 12/13	FCP4412	ATE
CL 65 AMG (216.379)	463	02/11 → 12/13		

For material availability see page 16-18 / Per la disponibilità materiali vedere a pagina 16-18

1128

FERODO

RACING

Updated on 17th Aug 2018

MERCEDES



KW



...MERCEDES					NOTE			NOTE
S280								
2.8 18v (W220)	150	02/99 → 09/02	FCP1661	BREMBO				
S320								
3.2 18v (W220)	165	02/99 → 08/02	FCP1661	BREMBO				
3.2 CDi 24v (W220)	145	09/99 → 08/02	FCP1661	BREMBO				
S430								
4.3 24v (W220)	205	09/98 → 09/02	FCP1661	BREMBO				
S500								
5.0 24v (W220)	225	10/98 → 12/01	FCP1661	BREMBO				
S55 AMG								
5.4 24v (W220)	265	09/99 → 08/02	FCP1661	BREMBO				
S600								
5.8 36v (W220) Not for armoured vehicles	270	09/99 → 08/02	FCP1661	BREMBO				
SL (R230)								
3.0 24v without sports package	170	08/07 →	FCP1661	BREMBO				
3.0 24v without sports package	170	06/09 →				FCP1568	ATE	
3.5 24v without sports package	200	03/06 → 11/08	FCP1661	BREMBO				
3.5 24v without sports package	232	11/07 →	FCP1661	BREMBO				
3.7 18v	180	08/02 → 07/05	FCP1661	BREMBO				
5.0 24v	225	10/01 → 01/12	FCP1661	BREMBO				
55 AMG	380	03/06 → 01/12	FRP3133	Brembo				
600	380	12/06 → 01/12	FRP3133	Brembo	From Ch.No. 134505			
63 AMG	386	03/08 → 01/12	FRP3133	Brembo				
65 AMG	450	03/04 → 01/12	FRP3133	BREMBO	From Chassis:122821			
65 AMG Black Series	493	07/08 → 01/12	FRP3133	Brembo				
SL24								
3.0 (R129)		01/89 → 06/93	FCP646	ATE				
3.2 (R129)		01/89 → 06/93	FCP646	ATE				
SL280								
2.8 (R129)		07/93 → 08/94	FCP646	ATE				
SL300								
3.0 (R129)		01/89 → 06/93	FCP646	ATE				
SL320								
3.2 (R129)		07/93 → 05/98	FCP646	ATE				
SL500								
5.0 (R129)		01/89 → 06/93	FCP646	ATE				
5.0 (R129) 32V	235	07/93 → 05/98	FCP646	ATE				
SL600								
6.0 (R129) 48V	290	07/93 →	FCP646	ATE				
SLC (R172)								
AMG SLC 43 (172.466)	270	01/16 →	FCP4806	BREMBO				
AMG SLC 43 (172.466)	270	01/16 →				FCP4587	LUCAS/TRW	
SLK (R170)								
3.2 18v AMG Kompressor	260	04/00 → 01/04	FCP1001	ATE				
3.2 V6	160	03/00 → 04/04	FCP1050	ATE				
SLK (R171)								
3.5 24v	200	06/04 → 01/06	FCP1661	BREMBO				
5.4 24v 55 AMG	265	04/08 →	FCP1661	BREMBO				
SLK (R172)								
55 AMG (172.475)	310	01/12 →	FCP4806	BREMBO				
55 AMG (172.475)	310	01/12 →				FCP4587	LUCAS/TRW	
55 AMG (172.475)	314	06/12 →	FCP4806	BREMBO				
55 AMG (172.475)	314	06/12 →				FCP4587	LUCAS/TRW	

MERCEDES

For material availability see page 16-18 / Per la disponibilità materiali vedere a pagina 16-18



KW

**...MERCEDES****SLK200**

2.0 Kompressor (R170) 16V

141 09/96 →

FCP1049

ATE

NOTE

NOTE

SLK230

2.3 Kompressor (R170) 16V

142 09/96 →

FCP1049

ATE

SLS AMG (C197)

6.2

420 03/10 →

FRP3133

Brembo

MERCURY**Merkur Scorpio**

01/88 → 12/89

FCP408

LUCAS/TRW

MG**MG B**

1.8 GT

68 01/62 → 12/81

FCP823

LOCKHEED

1.8 Not V8

59 01/62 → 12/81

FCP823

LOCKHEED

1.8 V8

01/62 → 12/81

FCP823

LOCKHEED

MG TF

115

85 03/02 →

FRP3085

LOCKHEED

120

88 03/02 →

FRP3085

LOCKHEED

135

100 03/02 →

FRP3085

LOCKHEED

160

118 03/02 →

FRP3085

LOCKHEED

MG ZR

1.4 i 105 16V

76 06/01 → 04/05

FCP613

LUCAS/TRW

1.4 i 105 16V

76 06/01 → 04/05

FCP613

LUCAS/TRW

FCP472

AKEBONO

1.8 i 120 16V

86 06/01 → 04/05

FCP613

LUCAS/TRW

1.8 i 120 16V

86 06/01 → 04/05

FCP613

LUCAS/TRW

FCP472

AKEBONO

1.8 i 160 16V

118 06/01 → 04/05

FCP613

LUCAS/TRW

FCP956

NISSIN

2.0 TDi 16V

74 06/01 → 04/05

FCP613

LUCAS/TRW

2.0 TDi 16V

74 06/01 → 04/05

FCP613

LUCAS/TRW

FCP472

AKEBONO

MG ZS

1.8 i 120 16V

86 07/01 → 04/05

FCP613

LUCAS/TRW

1.8 i 120 16V

86 07/01 → 04/05

FCP613

LUCAS/TRW

FCP472

AKEBONO

2.5 i 180 16V

130 07/01 → 04/05

FCP613

LUCAS/TRW

FCP956

NISSIN

MGF (RD)

1.8 i VVC

118 10/01 → 03/02

FRP3085

LOCKHEED

MGR V8

3.9 16V

140 10/92 → 12/95

FCP832

LOCKHEED

MINI**MINI (F55)**

1.2 One

75 11/14 →

FCP1747

LUCAS/TRW

1.2 One First

55 03/15 →

FCP1747

LUCAS/TRW

1.5 Cooper

100 07/14 →

FCP1747

LUCAS/TRW

1.5 Cooper D

85 07/14 →

FCP1747

LUCAS/TRW

1.5 One D

70 11/14 →

FCP1747

LUCAS/TRW

John Cooper Works

170 09/15 →

FCP4872

Brembo

MINI (F56)

1.2 One

75 03/14 →

FCP1747

LUCAS/TRW

1.2 One First

55 06/14 →

FCP1747

LUCAS/TRW

1.5 Cooper

100 12/13 →

FCP1747

LUCAS/TRW

1.5 Cooper D

85 12/13 →

FCP1747

LUCAS/TRW

1.5 One D

70 03/14 →

FCP1747

LUCAS/TRW

John Cooper Works

170 06/14 →

FCP4872

Brembo

For material availability see page 16-18 / Per la disponibilità materiali vedere a pagina 16-18

1130

FERODO

RACING

Updated on 17th Aug 2018

MERCEDES



KW



...MINI

				NOTE			NOTE
MINI (R50)							
1.4 One - ATE Front	55	04/03 → 10/06	FCP1499	ATE			
1.4 One - ATE Front	55	04/03 → 10/06			FCP1676	ATE	
1.4 One - TRW Front	55	04/03 → 10/06	FCP4080	LUCAS/TRW			
1.4 One - TRW Front	55	04/03 → 10/06			FCP1676	ATE	
1.4 One D - ATE Front	55	04/03 → 09/05	FCP1499	ATE			
1.4 One D - ATE Front	55	04/03 → 09/05			FCP1676	ATE	
1.4 One D - ATE Front	65	06/03 → 09/05	FCP1499	ATE			
1.4 One D - ATE Front	65	06/03 → 09/05			FCP1676	ATE	
1.4 One D - TRW Front	55	04/03 → 09/05	FCP4080	LUCAS/TRW			
1.4 One D - TRW Front	55	04/03 → 09/05			FCP1676	ATE	
1.4 One D - TRW Front	65	06/03 → 09/05	FCP4080	LUCAS/TRW			
1.4 One D - TRW Front	65	06/03 → 09/05			FCP1676	ATE	
1.6 Cooper	85	04/01 → 12/08	FCP1499	ATE			
1.6 Cooper	85	04/01 → 12/08			FCP1676	ATE	
1.6 One	66	04/01 → 07/07	FCP4080	LUCAS/TRW			
1.6 One	66	04/01 → 07/07			FCP1676	ATE	
1.6 One - without sports package	66	04/01 → 07/07	FCP1499	ATE			
1.6 One - without sports package	66	04/01 → 07/07			FCP1676	ATE	
MINI (R50,R53)							
1.4 One D	55	06/03 → 02/07	FCP1499	ATE			
1.4 One D	55	06/03 → 02/07			FCP1676	ATE	
John Cooper works	160	03/06 → 09/06	FCP1561	Brembo			
John Cooper works	160	03/06 → 09/06	FCP4080	LUCAS/TRW			
John Cooper works	160	03/06 → 09/06			FCP1676	ATE	
John Cooper works	160	03/06 → 09/06			FCP1975	LUCAS/TRW	
Works	155	11/03 → 09/06	FCP1499	ATE			
Works	155	11/03 → 09/06	FCP4080	LUCAS/TRW			
Works	155	11/03 → 09/06			FCP1676	ATE	
MINI (R52)							
1.6 Cooper	85	01/02 → 01/09	FCP1499	ATE			
1.6 Cooper	85	01/02 → 01/09			FCP1676	ATE	
1.6 Cooper S	120	02/02 → 12/08	FCP1499	ATE			
1.6 Cooper S	120	02/02 → 12/08			FCP1676	ATE	
1.6 Cooper S	120	04/02 → 01/09	FCP1499	ATE			
1.6 Cooper S	120	04/02 → 01/09			FCP1676	ATE	
1.6 Cooper S	125	01/02 → 01/09	FCP1499	ATE			
1.6 Cooper S	125	01/02 → 01/09			FCP1676	ATE	
1.6 Cooper S Works	155	07/04 → 01/09	FCP4080	LUCAS/TRW			
1.6 Cooper S Works	155	07/04 → 01/09			FCP1676	ATE	
1.6 One	66	08/04 → 07/07	FCP1499	ATE			
1.6 One	66	08/04 → 07/07			FCP1676	ATE	
MINI (R53)							
1.6 Cooper S	125	05/04 → 10/06	FCP1499	ATE			
1.6 Cooper S	125	05/04 → 10/06			FCP1676	ATE	
1.6 Cooper S JCW GP	160	01/06 → 07/07	FCP4080	LUCAS/TRW			
1.6 Cooper S JCW GP	160	01/06 → 07/07			FCP1676	ATE	
1.6 Cooper S Works	147	11/03 → 06/05	FCP4080	LUCAS/TRW			
1.6 Cooper S Works	147	11/03 → 06/05			FCP1676	ATE	
1.6 Cooper S Works	155	07/05 → 10/06	FCP4080	LUCAS/TRW			
1.6 Cooper S Works	155	07/05 → 10/06			FCP1676	ATE	
MINI (R55)							
Clubman 1.4 One	70	03/09 → 02/10	FCP1747	LUCAS/TRW			
Clubman 1.4 One	70	03/09 → 02/10			FCP1975	LUCAS/TRW	
Clubman 1.4 One	72	03/10 →	FCP1747	LUCAS/TRW			
Clubman 1.4 One	72	03/10 →			FCP1975	LUCAS/TRW	
Clubman 1.6 Cooper	85	03/10 →	FCP1747	LUCAS/TRW			
Clubman 1.6 Cooper	85	03/10 →	FCP1561	BREMBO			
Clubman 1.6 Cooper	85	03/10 →			FCP1975	LUCAS/TRW	
Clubman 1.6 Cooper	88	09/07 →	FCP1747	LUCAS/TRW			
Clubman 1.6 Cooper	88	09/07 →			FCP1975	LUCAS/TRW	
Clubman 1.6 Cooper	90	03/10 →	FCP1747	LUCAS/TRW			
Clubman 1.6 Cooper	90	03/10 →			FCP1975	LUCAS/TRW	
Clubman 1.6 Cooper D	80	10/07 →	FCP1747	LUCAS/TRW			
Clubman 1.6 Cooper D	80	10/07 →			FCP1975	LUCAS/TRW	
Clubman 1.6 Cooper D	82	03/10 →	FCP1747	LUCAS/TRW			
Clubman 1.6 Cooper D	82	03/10 →			FCP1975	LUCAS/TRW	
Clubman 1.6 Cooper S	120	10/07 →	FCP1561	BREMBO			
Clubman 1.6 Cooper S	120	10/07 →			FCP1975	LUCAS/TRW	
Clubman 1.6 Cooper S	128	01/07 →	FCP1561	BREMBO			
Clubman 1.6 Cooper S	128	01/07 →	FCP4080	LUCAS/TRW			
Clubman 1.6 Cooper S	128	01/07 →			FCP1975	LUCAS/TRW	
Clubman 1.6 Cooper S	135	03/10 →	FCP4080	LUCAS/TRW			
Clubman 1.6 Cooper S	135	03/10 →	FCP1561	BREMBO			

For material availability see page 16-18 / Per la disponibilità materiali vedere a pagina 16-18



KW



...MINI

...MINI (R55)

					NOTE			NOTE
Clubman 1.6 Cooper S	135	03/10 →				FCP1975	LUCAS/TRW	
Clubman 1.6 One	72	03/10 →	FCP1747	LUCAS/TRW		FCP1975	LUCAS/TRW	
Clubman 1.6 One	72	03/10 →				FCP1975	LUCAS/TRW	
Clubman 1.6 One D	66	03/10 →	FCP1747	LUCAS/TRW				
Clubman 1.6 One D	66	03/10 →				FCP1975	LUCAS/TRW	
Clubman 1.6 S JCW	155	03/08 →	FCP1561	BREMBO				
Clubman 1.6 S JCW Tuning-Kit	147	03/10 →	FCP1561	BREMBO				
Clubman 1.6 S JCW Tuning-Kit	147	03/10 →				FCP1975	LUCAS/TRW	
Clubman 2.0 Cooper D	82	03/11 →	FCP1747	LUCAS/TRW				
Clubman 2.0 Cooper D	82	03/11 →	FCP1561	BREMBO				
Clubman 2.0 Cooper D	82	03/11 →				FCP1975	LUCAS/TRW	
Clubman 2.0 Cooper SD	100	02/11 →	FCP1747	LUCAS/TRW				
Clubman 2.0 Cooper SD	100	02/11 →	FCP1561	BREMBO				
Clubman 2.0 Cooper SD	100	02/11 →				FCP1975	LUCAS/TRW	
Clubman 2.0 Cooper SD	105	03/11 →	FCP1747	LUCAS/TRW				
Clubman 2.0 Cooper SD	105	03/11 →	FCP1561	BREMBO				
Clubman 2.0 Cooper SD	105	03/11 →				FCP1975	LUCAS/TRW	

MINI (R56)

1.4 One LPG	55	03/09 → 03/10	FCP1561	BREMBO				
1.4 One LPG	55	03/09 → 03/10				FCP1975	LUCAS/TRW	
1.4 One LPG - Front disc 280mm	55	03/09 → 03/10	FCP1747	LUCAS/TRW				
1.4 One LPG - Front disc 280mm	55	03/09 → 03/10				FCP1975	LUCAS/TRW	
1.4 One	55	03/09 → 03/10	FCP1561	BREMBO				
1.4 One	55	03/09 → 03/10				FCP1975	LUCAS/TRW	
1.4 One	70	11/06 → 03/10	FCP1747	LUCAS/TRW				
1.4 One	70	11/06 → 03/10	FCP1561	BREMBO				
1.4 One	70	11/06 → 03/10				FCP1975	LUCAS/TRW	
1.4 One - Front disc 280mm	55	03/09 → 03/10	FCP1747	LUCAS/TRW				
1.4 One - Front disc 280mm	55	03/09 → 03/10				FCP1975	LUCAS/TRW	
1.4 One - Front disc 294mm	55	03/09 → 03/10	FCP4080	LUCAS/TRW				
1.4 One - Front disc 294mm	55	03/09 → 03/10				FCP1975	LUCAS/TRW	
1.4 One - Front disc 294mm	70	11/06 → 03/10	FCP4080	LUCAS/TRW				
1.4 One - Front disc 294mm	70	11/06 → 03/10				FCP1975	LUCAS/TRW	
1.4 One LPG - Front disc 294mm	55	03/09 → 03/10	FCP4080	LUCAS/TRW				
1.4 One LPG - Front disc 294mm	55	03/09 → 03/10				FCP1975	LUCAS/TRW	
1.6 Cooper	85	03/10 →	FCP1561	BREMBO				
1.6 Cooper	85	03/10 →				FCP1975	LUCAS/TRW	
1.6 Cooper	88	11/06 → 08/10	FCP1561	BREMBO				
1.6 Cooper	88	11/06 → 08/10				FCP1975	LUCAS/TRW	
1.6 Cooper	90	03/10 →	FCP1561	BREMBO				
1.6 Cooper	90	03/10 →				FCP1975	LUCAS/TRW	
1.6 Cooper - Front disc 280mm	85	03/10 →	FCP1747	LUCAS/TRW				
1.6 Cooper - Front disc 280mm	85	03/10 →				FCP1975	LUCAS/TRW	
1.6 Cooper - Front disc 280mm	88	11/06 → 08/10	FCP1747	LUCAS/TRW				
1.6 Cooper - Front disc 280mm	90	03/10 →	FCP1747	LUCAS/TRW				
1.6 Cooper - Front disc 280mm	90	03/10 →				FCP1975	LUCAS/TRW	
1.6 Cooper - Front disc 294mm	85	03/10 →	FCP4080	LUCAS/TRW				
1.6 Cooper - Front disc 294mm	85	03/10 →				FCP1975	LUCAS/TRW	
1.6 Cooper - Front disc 294mm	88	11/06 → 08/10	FCP4080	LUCAS/TRW				
1.6 Cooper - Front disc 294mm	88	11/06 → 08/10				FCP1975	LUCAS/TRW	
1.6 Cooper - Front disc 294mm	90	03/10 →	FCP4080	LUCAS/TRW				
1.6 Cooper - Front disc 294mm	90	03/10 →				FCP1975	LUCAS/TRW	
1.6 Cooper D	80	11/06 → 09/10	FCP1561	BREMBO				
1.6 Cooper D	80	11/06 → 09/10				FCP1975	LUCAS/TRW	
1.6 Cooper D	82	06/10 →	FCP1561	BREMBO				
1.6 Cooper D	82	06/10 →				FCP1975	LUCAS/TRW	
1.6 Cooper D - Front disc 280mm	80	11/06 → 09/10	FCP1747	LUCAS/TRW				
1.6 Cooper D - Front disc 280mm	80	11/06 → 09/10				FCP1975	LUCAS/TRW	
1.6 Cooper D - Front disc 280mm	82	06/10 →	FCP1747	LUCAS/TRW				
1.6 Cooper D - Front disc 280mm	82	06/10 →				FCP1975	LUCAS/TRW	
1.6 Cooper D - Front disc 294mm	80	11/06 → 09/10	FCP4080	LUCAS/TRW				
1.6 Cooper D - Front disc 294mm	80	11/06 → 09/10				FCP1975	LUCAS/TRW	
1.6 Cooper D - Front disc 294mm	82	06/10 →	FCP4080	LUCAS/TRW				
1.6 Cooper D - Front disc 294mm	82	06/10 →				FCP1975	LUCAS/TRW	
1.6 Cooper S	120	03/10 →	FCP4080	LUCAS/TRW				
1.6 Cooper S	120	03/10 →	FCP1561	BREMBO				
1.6 Cooper S	120	03/10 →				FCP1975	LUCAS/TRW	
1.6 Cooper S	128	11/06 → 02/10	FCP4080	LUCAS/TRW				
1.6 Cooper S	128	11/06 → 02/10	FCP1561	BREMBO				
1.6 Cooper S	128	11/06 → 02/10				FCP1975	LUCAS/TRW	
1.6 Cooper S	135	03/10 →	FCP1561	BREMBO				
1.6 Cooper S	135	03/10 →	FCP4080	LUCAS/TRW				
1.6 Cooper S	135	03/10 →				FCP1975	LUCAS/TRW	
1.6 Cooper S	135	03/10 →				FCP1975	LUCAS/TRW	
1.6 Cooper S JCW	155	01/09 →	FCP1561	BREMBO				
1.6 Cooper S JCW	155	01/09 →				FCP1975	LUCAS/TRW	

For material availability see page 16-18 / Per la disponibilità materiali vedere a pagina 16-18



KW

**...MINI****...MINI (R56)**

					NOTE			NOTE
1.6 Cooper S JCW Tuning-Kit	147	01/12 →	FCP4080	LUCAS/TRW				
1.6 Cooper S JCW Tuning-Kit	147	01/12 →	FCP1561	BREMBO				
1.6 Cooper S JCW Tuning-Kit	147	01/12 →			FCP1975	LUCAS/TRW		
1.6 Cooper S JCW/S Works	155	03/08 →	FCP1561	BREMBO				
1.6 Cooper S JCW/S Works	155	03/08 →			FCP1975	LUCAS/TRW		
1.6 One	55	03/10 →	FCP1561	BREMBO				
1.6 One	55	03/10 →			FCP1975	LUCAS/TRW		
1.6 One	72	03/10 →	FCP1561	BREMBO				
1.6 One	72	03/10 →			FCP1975	LUCAS/TRW		
1.6 One - Front disc 280mm	55	03/10 →	FCP1747	LUCAS/TRW				
1.6 One - Front disc 280mm	55	03/10 →			FCP1975	LUCAS/TRW		
1.6 One - Front disc 280mm	72	03/10 →	FCP1747	LUCAS/TRW				
1.6 One - Front disc 280mm	72	03/10 →			FCP1975	LUCAS/TRW		
1.6 One - Front disc 294mm	55	03/10 →	FCP4080	LUCAS/TRW				
1.6 One - Front disc 294mm	55	03/10 →			FCP1975	LUCAS/TRW		
1.6 One - Front disc 294mm	72	03/10 →	FCP4080	LUCAS/TRW				
1.6 One - Front disc 294mm	72	03/10 →			FCP1975	LUCAS/TRW		
1.6 One D	66	06/09 → 07/10	FCP1561	BREMBO				
1.6 One D	66	06/09 → 07/10			FCP1975	LUCAS/TRW		
1.6 One D	66	07/10 →	FCP1561	BREMBO				
1.6 One D	66	07/10 →			FCP1975	LUCAS/TRW		
1.6 One D - Front disc 280mm	66	06/09 → 07/10	FCP1747	LUCAS/TRW				
1.6 One D - Front disc 280mm	66	06/09 → 07/10			FCP1975	LUCAS/TRW		
1.6 One D - Front disc 280mm	66	07/10 →	FCP1747	LUCAS/TRW				
1.6 One D - Front disc 280mm	66	07/10 →			FCP1975	LUCAS/TRW		
1.6 One D - Front disc 294mm	66	06/09 → 07/10	FCP4080	LUCAS/TRW				
1.6 One D - Front disc 294mm	66	06/09 → 07/10			FCP1975	LUCAS/TRW		
1.6 One D - Front disc 294mm	66	07/10 →	FCP4080	LUCAS/TRW				
1.6 One D - Front disc 294mm	66	07/10 →			FCP1975	LUCAS/TRW		
2.0 Cooper D	82	03/11 →	FCP1561	BREMBO				
2.0 Cooper D	82	03/11 →			FCP1975	LUCAS/TRW		
2.0 Cooper D - Front disc 280mm	82	03/11 →	FCP1747	LUCAS/TRW				
2.0 Cooper D - Front disc 280mm	82	03/11 →			FCP1975	LUCAS/TRW		
2.0 Cooper D - Front disc 294mm	82	03/11 →	FCP4080	LUCAS/TRW				
2.0 Cooper D - Front disc 294mm	82	03/11 →			FCP1975	LUCAS/TRW		
2.0 Cooper SD	100	02/11 →	FCP1561	BREMBO				
2.0 Cooper SD	100	02/11 →			FCP1975	LUCAS/TRW		
2.0 Cooper SD	105	03/11 →	FCP1561	BREMBO				
2.0 Cooper SD	105	03/11 →			FCP1975	LUCAS/TRW		
2.0 Cooper SD - Front disc 280mm	100	02/11 →	FCP1747	LUCAS/TRW				
2.0 Cooper SD - Front disc 280mm	100	02/11 →			FCP1975	LUCAS/TRW		
2.0 Cooper SD - Front disc 280mm	105	03/11 →	FCP1747	LUCAS/TRW				
2.0 Cooper SD - Front disc 280mm	105	03/11 →			FCP1975	LUCAS/TRW		
2.0 Cooper SD - Front disc 294mm	100	02/11 →	FCP4080	LUCAS/TRW				
2.0 Cooper SD - Front disc 294mm	100	02/11 →			FCP1975	LUCAS/TRW		
2.0 Cooper SD - Front disc 294mm	105	03/11 →	FCP4080	LUCAS/TRW				
2.0 Cooper SD - Front disc 294mm	105	03/11 →			FCP1975	LUCAS/TRW		
Cooper	88	10/06 → 02/12	FCP1561	Brembo				
Cooper	88	10/06 → 02/12	FCP1747	LUCAS/TRW				
Cooper	88	10/06 → 02/12	FCP4080	LUCAS/TRW				
Cooper	88	10/06 → 02/12			FCP1975	LUCAS/TRW		
Cooper D	80	11/06 → 09/10	FCP1561	Brembo				
Cooper D	80	11/06 → 09/10	FCP1747	LUCAS/TRW				
Cooper D	80	11/06 → 09/10	FCP4080	LUCAS/TRW				
Cooper D	80	11/06 → 09/10			FCP1975	LUCAS/TRW		
Cooper S	128	10/06 → 01/11	FCP1561	Brembo				
Cooper S	128	10/06 → 01/11	FCP4080	LUCAS/TRW				
Cooper S	128	10/06 → 01/11			FCP1975	LUCAS/TRW		
John Cooper Works	141	11/06 → 12/11	FCP1561	Brembo				
John Cooper Works	141	11/06 → 12/11			FCP1975	LUCAS/TRW		
John Cooper Works GP	160	01/12 → 12/13	FCP4218	BREMBO				
John Cooper Works GP	160	01/12 → 12/13	FCP4080	LUCAS/TRW				
John Cooper Works GP	160	01/12 → 12/13			FCP1676	TEVES		
John Cooper Works GP	160	01/12 → 12/13			FCP1975	LUCAS/TRW		
One	70	11/06 → 03/10	FCP1561	Brembo				
One	70	11/06 → 03/10	FCP1747	LUCAS/TRW				
One	70	11/06 → 03/10	FCP4080	LUCAS/TRW				
One	70	11/06 → 03/10			FCP1975	LUCAS/TRW		

MINI (R57)

1.6 Cooper	85	03/09 →	FCP1747	LUCAS/TRW				
1.6 Cooper	85	03/09 →			FCP1975	LUCAS/TRW		
1.6 Cooper	88	03/09 →	FCP1561	BREMBO				
1.6 Cooper	88	03/09 →			FCP1975	LUCAS/TRW		
1.6 Cooper	90	03/10 →	FCP1561	BREMBO				
1.6 Cooper	90	03/10 →			FCP1975	LUCAS/TRW		
1.6 Cooper - Front disc 280mm	88	03/09 →	FCP1747	LUCAS/TRW				

For material availability see page 16-18 / Per la disponibilità materiali vedere a pagina 16-18

FERODO

RACING

Updated on 17th Aug 2018

1133



KW



...MINI

...MINI (R57)

					NOTE			NOTE
1.6 Cooper - Front disc 280mm	88	03/09 →				FCP1975	LUCAS/TRW	
1.6 Cooper - Front disc 280mm	90	03/10 →	FCP1747	LUCAS/TRW				
1.6 Cooper - Front disc 280mm	90	03/10 →				FCP1975	LUCAS/TRW	
1.6 Cooper - Front disc 294mm	88	03/09 →	FCP4080	LUCAS/TRW				
1.6 Cooper - Front disc 294mm	88	03/09 →				FCP1975	LUCAS/TRW	
1.6 Cooper - Front disc 294mm	90	03/10 →	FCP4080	LUCAS/TRW				
1.6 Cooper - Front disc 294mm	90	03/10 →				FCP1975	LUCAS/TRW	
1.6 Cooper S	120	03/10 →	FCP4080	LUCAS/TRW				
1.6 Cooper S	120	03/10 →	FCP1561	BREMBO				
1.6 Cooper S	120	03/10 →				FCP1975	LUCAS/TRW	
1.6 Cooper S	128	03/09 →	FCP4080	LUCAS/TRW				
1.6 Cooper S	128	03/09 →	FCP1561	BREMBO				
1.6 Cooper S	128	03/09 →				FCP1975	LUCAS/TRW	
1.6 Cooper S	135	03/10 →	FCP1561	BREMBO				
1.6 Cooper S	135	03/10 →	FCP4080	LUCAS/TRW				
1.6 Cooper S	135	03/10 →				FCP1975	LUCAS/TRW	
1.6 Cooper S	135	03/10 →				FCP1975	LUCAS/TRW	
1.6 Cooper S JCW	155	03/08 →	FCP1561	BREMBO				
1.6 Cooper S JCW	155	03/08 →				FCP1975	LUCAS/TRW	
1.6 Cooper S JCW Tuning-Kit	147	03/10 →	FCP4080	LUCAS/TRW				
1.6 Cooper S JCW Tuning-Kit	147	03/10 →	FCP1561	BREMBO				
1.6 Cooper S JCW Tuning-Kit	147	03/10 →				FCP1975	LUCAS/TRW	
1.6 D Cooper	82	06/10 →	FCP1561	BREMBO				
1.6 D Cooper	82	06/10 →				FCP1975	LUCAS/TRW	
1.6 D Cooper - Front disc 280mm	82	06/10 →	FCP1747	LUCAS/TRW				
1.6 D Cooper - Front disc 280mm	82	06/10 →				FCP1975	LUCAS/TRW	
1.6 D Cooper - Front disc 294mm	82	06/10 →	FCP4080	LUCAS/TRW				
1.6 D Cooper - Front disc 294mm	82	06/10 →				FCP1975	LUCAS/TRW	
1.6 One	72	03/10 →	FCP1561	BREMBO				
1.6 One	72	03/10 →				FCP1975	LUCAS/TRW	
1.6 One - Front disc 280mm	72	03/10 →	FCP1747	LUCAS/TRW				
1.6 One - Front disc 280mm	72	03/10 →				FCP1975	LUCAS/TRW	
1.6 One - Front disc 294mm	72	03/10 →	FCP4080	LUCAS/TRW				
1.6 One - Front disc 294mm	72	03/10 →				FCP1975	LUCAS/TRW	
2.0 Cooper D	82	03/11 →	FCP1561	BREMBO				
2.0 Cooper D	82	03/11 →				FCP1975	LUCAS/TRW	
2.0 Cooper D - Front disc 280mm	82	03/11 →	FCP1747	LUCAS/TRW				
2.0 Cooper D - Front disc 280mm	82	03/11 →				FCP1975	LUCAS/TRW	
2.0 Cooper D - Front disc 294mm	82	03/11 →	FCP4080	LUCAS/TRW				
2.0 Cooper D - Front disc 294mm	82	03/11 →				FCP1975	LUCAS/TRW	
2.0 Cooper SD	100	03/11 →	FCP1561	BREMBO				
2.0 Cooper SD	100	03/11 →				FCP1975	LUCAS/TRW	
2.0 Cooper SD	105	03/11 →	FCP1561	BREMBO				
2.0 Cooper SD	105	03/11 →				FCP1975	LUCAS/TRW	
2.0 Cooper SD - Front disc 280mm	100	03/11 →	FCP1747	LUCAS/TRW				
2.0 Cooper SD - Front disc 280mm	100	03/11 →				FCP1975	LUCAS/TRW	
2.0 Cooper SD - Front disc 280mm	105	03/11 →	FCP1747	LUCAS/TRW				
2.0 Cooper SD - Front disc 280mm	105	03/11 →				FCP1975	LUCAS/TRW	
2.0 Cooper SD - Front disc 294mm	100	03/11 →	FCP4080	LUCAS/TRW				
2.0 Cooper SD - Front disc 294mm	100	03/11 →				FCP1975	LUCAS/TRW	
2.0 Cooper SD - Front disc 294mm	105	03/11 →	FCP4080	LUCAS/TRW				
2.0 Cooper SD - Front disc 294mm	105	03/11 →				FCP1975	LUCAS/TRW	

MINI CLUBMAN (F54)

John Cooper Works	170	11/15 →	FCP4872	Brembo				
One	75	02/15 →	FCP1747	LUCAS/TRW				
One D	85	02/15 →	FCP1747	LUCAS/TRW				

MINI CLUBMAN (R55)

John Cooper Works	141	10/08 → 02/10	FCP4080	LUCAS/TRW				
John Cooper Works	141	10/08 → 02/10				FCP1975	LUCAS/TRW	

MINI CLUBVAN (R55)

Cooper	90	12/12 →	FCP1561	Brembo				
Cooper	90	12/12 →	FCP1747	LUCAS/TRW				
Cooper	90	12/12 →				FCP1975	LUCAS/TRW	
Cooper D	82	12/12 →	FCP1561	Brembo				
Cooper D	82	12/12 →	FCP1747	LUCAS/TRW				
Cooper D	82	12/12 →				FCP1975	LUCAS/TRW	
Cooper D	82	12/12 →	FCP1747	LUCAS/TRW				
Cooper D	82	12/12 →				FCP1975	LUCAS/TRW	
One	72	12/12 →	FCP1561	Brembo				
One	72	12/12 →	FCP1747	LUCAS/TRW				
One	72	12/12 →				FCP1975	LUCAS/TRW	

For material availability see page 16-18 / Per la disponibilità materiali vedere a pagina 16-18



KW

**...MINI****MINI Convertible (F57)**

Cooper	100	11/14 →	FCP1747	LUCAS/TRW			
Cooper D	85	12/14 →	FCP1747	LUCAS/TRW			
John Cooper Works	170	05/15 →	FCP4872	Brembo			
One	75	06/15 →	FCP1747	LUCAS/TRW			

MINI Convertible (R57)

Cooper S	125	11/07 → 12/08	FCP4080	LUCAS/TRW			
Cooper S	125	11/07 → 12/08	FCP1561	Brembo			
Cooper S	125	11/07 → 12/08			FCP1975	LUCAS/TRW	
One	72	03/10 → 06/15	FCP1561	Brembo			
One	72	03/10 → 06/15	FCP1747	LUCAS/TRW			
One	72	03/10 → 06/15	FCP4080	LUCAS/TRW			
One	72	03/10 → 06/15			FCP1975	LUCAS/TRW	

MINI COUNTRYMAN (R60)

1.6 Cooper	85	06/10 →	FCP4080	LUCAS/TRW			
1.6 Cooper	85	06/10 →			FCP1806	LUCAS/TRW	
1.6 Cooper	90	06/10 →	FCP4080	LUCAS/TRW			
1.6 Cooper	90	06/10 →			FCP1806	LUCAS/TRW	
1.6 Cooper D	82	06/10 →	FCP4080	LUCAS/TRW			
1.6 Cooper D	82	06/10 →			FCP1806	LUCAS/TRW	
1.6 Cooper DX	82	06/10 →	FCP4080	LUCAS/TRW			
1.6 Cooper DX	82	06/10 →			FCP1806	LUCAS/TRW	
1.6 Cooper S	120	06/10 →	FCP4080	LUCAS/TRW			
1.6 Cooper S	120	06/10 →			FCP1806	LUCAS/TRW	
1.6 Cooper S	135	06/10 →	FCP4080	LUCAS/TRW			
1.6 Cooper S	135	06/10 →			FCP1806	LUCAS/TRW	
1.6 Cooper S/Cooper SX	135	06/10 →	FCP4080	LUCAS/TRW			
1.6 Cooper S/Cooper SX	135	06/10 →			FCP1806	LUCAS/TRW	
1.6 Cooper SX	120	06/10 →	FCP4080	LUCAS/TRW			
1.6 Cooper SX	120	06/10 →			FCP1806	LUCAS/TRW	
1.6 One	72	06/10 →	FCP4080	LUCAS/TRW			
1.6 One	72	06/10 →			FCP1806	LUCAS/TRW	
1.6 One D	66	06/10 →	FCP4080	LUCAS/TRW			
1.6 One D	66	06/10 →			FCP1806	LUCAS/TRW	
1.6 S JCW	160	06/12 →	FCP4080	LUCAS/TRW			
1.6 S JCW	160	06/12 →			FCP1806	LUCAS/TRW	
1.6 S JCW Tuning-Kit	147	02/12 →	FCP4080	LUCAS/TRW			
1.6 S JCW Tuning-Kit	147	02/12 →			FCP1806	LUCAS/TRW	
2.0 Cooper D	82	03/11 →	FCP4080	LUCAS/TRW			
2.0 Cooper D	82	03/11 →			FCP1806	LUCAS/TRW	
2.0 Cooper DX	82	03/11 →	FCP4080	LUCAS/TRW			
2.0 Cooper DX	82	03/11 →			FCP1806	LUCAS/TRW	
2.0 Cooper SD	100	03/11 →	FCP4080	LUCAS/TRW			
2.0 Cooper SD	100	03/11 →			FCP1806	LUCAS/TRW	
2.0 Cooper SD	105	03/11 →	FCP4080	LUCAS/TRW			
2.0 Cooper SD	105	03/11 →			FCP1806	LUCAS/TRW	
2.0 Cooper SDX	100	02/11 →	FCP4080	LUCAS/TRW			
2.0 Cooper SDX	100	02/11 →			FCP1806	LUCAS/TRW	
2.0 Cooper SDX	105	03/11 →	FCP4080	LUCAS/TRW			
2.0 Cooper SDX	105	03/11 →			FCP1806	LUCAS/TRW	
Cooper	88	09/10 →	FCP4080	LUCAS/TRW			
Cooper	88	09/10 →			FCP1806	LUCAS/TRW	
Cooper ALL4	90	11/12 →	FCP4080	LUCAS/TRW			
Cooper ALL4	90	11/12 →	FCP4080	LUCAS/TRW			
Cooper ALL4	90	11/12 →			FCP1806	LUCAS/TRW	
Cooper ALL4	90	11/12 →			FCP1806	LUCAS/TRW	
Cooper S	140	07/14 →	FCP4080	LUCAS/TRW			
Cooper S	140	07/14 →			FCP1806	LUCAS/TRW	
Cooper S ALL4	140	07/14 →	FCP4080	LUCAS/TRW			
Cooper S ALL4	140	07/14 →			FCP1806	LUCAS/TRW	
John Cooper Works ALL4	155	09/12 →	FCP4080	LUCAS/TRW			
John Cooper Works ALL4	155	09/12 →			FCP1806	LUCAS/TRW	

MINI Coupe (R58)

1.6 Cooper	85	09/11 →	FCP1747	LUCAS/TRW			
1.6 Cooper	85	09/11 →	FCP1561	BREMBO			
1.6 Cooper	85	09/11 →			FCP1975	LUCAS/TRW	
1.6 Cooper	90	09/11 →	FCP1747	LUCAS/TRW			
1.6 Cooper	90	09/11 →			FCP1975	LUCAS/TRW	
1.6 Cooper S	120	09/11 →	FCP4080	LUCAS/TRW			
1.6 Cooper S	120	09/11 →			FCP1975	LUCAS/TRW	
1.6 Cooper S	135	09/11 →	FCP4080	LUCAS/TRW			
1.6 Cooper S	135	09/11 →			FCP1975	LUCAS/TRW	
1.6 Cooper S JCW	155	09/11 →	FCP1561	BREMBO			
1.6 Cooper S JCW	155	09/11 →			FCP1975	LUCAS/TRW	
1.6 S JCW Tuning-Kit	147	09/11 →	FCP4080	LUCAS/TRW			

For material availability see page 16-18 / Per la disponibilità materiali vedere a pagina 16-18

FERODO

RACING

Updated on 17th Aug 2018

1135

MINI



KW

**...MINI****...MINI Coupe (R58)**

					NOTE			NOTE
1.6 S JCW Tuning-Kit	147	09/11 →				FCP1975	LUCAS/TRW	
2.0 Cooper SD	100	09/11 →	FCP1747	LUCAS/TRW				
2.0 Cooper SD	100	09/11 →	FCP1561	BREMBO				
2.0 Cooper SD	100	09/11 →				FCP1975	LUCAS/TRW	
2.0 Cooper SD	105	09/11 →	FCP1747	LUCAS/TRW				
2.0 Cooper SD	105	09/11 →				FCP1975	LUCAS/TRW	
John Cooper Works	170	09/15 →	FCP1561	Brembo				
John Cooper Works	170	09/15 →				FCP1975	LUCAS/TRW	

MINI PACEMAN (R61)

1.6 Cooper	90	01/13 →	FCP4080	LUCAS/TRW		FCP1806	LUCAS/TRW	
1.6 Cooper	90	01/13 →						
1.6 Cooper D	82	01/13 →	FCP4080	LUCAS/TRW				
1.6 Cooper D	82	01/13 →				FCP1806	LUCAS/TRW	
1.6 Cooper DX	82	01/13 →	FCP4080	LUCAS/TRW				
1.6 Cooper DX	82	01/13 →				FCP1806	LUCAS/TRW	
1.6 Cooper S	135	01/13 →	FCP4080	LUCAS/TRW				
1.6 Cooper S	135	01/13 →				FCP1806	LUCAS/TRW	
1.6 Cooper SX	135	01/13 →	FCP4080	LUCAS/TRW				
1.6 Cooper SX	135	01/13 →				FCP1806	LUCAS/TRW	
1.6 Cooper SX JCW	160	01/13 →	FCP4080	LUCAS/TRW				
1.6 Cooper SX JCW	160	01/13 →				FCP1806	LUCAS/TRW	
2.0 Cooper SD	105	01/13 →	FCP4080	LUCAS/TRW				
2.0 Cooper SD	105	01/13 →				FCP1806	LUCAS/TRW	
2.0 Cooper SDX	105	01/13 →	FCP4080	LUCAS/TRW				
2.0 Cooper SDX	105	01/13 →				FCP1806	LUCAS/TRW	
Cooper	88	05/13 →	FCP4080	LUCAS/TRW				
Cooper	88	05/13 →				FCP1806	LUCAS/TRW	
Cooper ALL4	90	07/14 →	FCP4080	LUCAS/TRW				
Cooper ALL4	90	07/14 →				FCP1806	LUCAS/TRW	
Cooper ALL4	90	11/14 →	FCP4080	LUCAS/TRW				
Cooper ALL4	90	11/14 →				FCP1806	LUCAS/TRW	
Cooper D	82	09/12 →	FCP4080	LUCAS/TRW				
Cooper D	82	09/12 →				FCP1806	LUCAS/TRW	
Cooper D ALL4	82	09/12 →	FCP4080	LUCAS/TRW				
Cooper D ALL4	82	09/12 →				FCP1806	LUCAS/TRW	
Cooper S	140	07/14 →	FCP4080	LUCAS/TRW				
Cooper S	140	07/14 →				FCP1806	LUCAS/TRW	
Cooper S ALL4	120	04/12 →	FCP4080	LUCAS/TRW				
Cooper S ALL4	120	04/12 →				FCP1806	LUCAS/TRW	
Cooper S ALL4	140	07/14 →	FCP4080	LUCAS/TRW				
Cooper S ALL4	140	07/14 →				FCP1806	LUCAS/TRW	
Cooper SD ALL4	100	10/12 →	FCP4080	LUCAS/TRW				
Cooper SD ALL4	100	10/12 →				FCP1806	LUCAS/TRW	
John Cooper Works	155	09/12 →	FCP4080	LUCAS/TRW				
John Cooper Works	155	09/12 →				FCP1806	LUCAS/TRW	

MINI Roadster (R59)

1.6 Cooper	85	02/12 →	FCP4080	LUCAS/TRW				
1.6 Cooper	85	02/12 →	FCP1561	BREMBO				
1.6 Cooper	85	02/12 →				FCP1975	LUCAS/TRW	
1.6 Cooper	90	02/12 →	FCP4080	LUCAS/TRW				
1.6 Cooper	90	02/12 →	FCP1561	BREMBO				
1.6 Cooper	90	02/12 →				FCP1975	LUCAS/TRW	
1.6 Cooper S	120	02/12 →	FCP4080	LUCAS/TRW				
1.6 Cooper S	120	02/12 →	FCP1561	BREMBO				
1.6 Cooper S	120	02/12 →				FCP1975	LUCAS/TRW	
1.6 Cooper S	135	02/12 →	FCP4080	LUCAS/TRW				
1.6 Cooper S	135	02/12 →	FCP1561	BREMBO				
1.6 Cooper S	135	02/12 →				FCP1975	LUCAS/TRW	
1.6 Cooper S JCW	155	02/12 →	FCP1561	BREMBO				
1.6 Cooper S JCW	155	02/12 →				FCP1975	LUCAS/TRW	
1.6 S JCW Tuning-Kit	147	02/12 →	FCP4080	LUCAS/TRW				
1.6 S JCW Tuning-Kit	147	02/12 →				FCP1975	LUCAS/TRW	
2.0 Cooper SD	100	02/12 →	FCP1747	LUCAS/TRW				
2.0 Cooper SD	100	02/12 →	FCP1561	BREMBO				
2.0 Cooper SD	100	02/12 →				FCP1975	LUCAS/TRW	
2.0 Cooper SD	105	02/12 →	FCP1747	LUCAS/TRW				
2.0 Cooper SD	105	02/12 →	FCP1561	BREMBO				
2.0 Cooper SD	105	02/12 →				FCP1975	LUCAS/TRW	

For material availability see page 16-18 / Per la disponibilità materiali vedere a pagina 16-18

1136

FERODO

RACING

Updated on 17th Aug 2018



KW



MITSUBISHI

3000 GT, GTO

3.0 (Turbo) Z16A 24V 210 08/92 → 04/96 **FCP765** AKEBONO

Carisma

1.9 TDi DA4A 66 01/97 → **FCP1093** LUCAS/TRW

CARISMA (DA_)

1.8 (DA2A) 85 07/95 → 07/97 **FCP1093** LUCAS/TRW

1.8 16V GDI (DA2A) 92 09/97 → 06/06 **FCP1093** LUCAS/TRW

1.8 MSX - 16V (DA2A) 103 07/95 → 07/97 **FCP1093** LUCAS/TRW

CARISMA Saloon (DA_)

1.8 (DA2A) 85 09/96 → 09/97 **FCP1093** LUCAS/TRW

1.8 16V GDI (DA2A) 92 09/97 → 06/06 **FCP1093** LUCAS/TRW

Galant

2.0 05/90 → 12/92 **FCP765** AKEBONO

2.5 24V 125 01/93 → 03/97 **FCP765** AKEBONO

L200

1.6 i L021P 01/79 → 10/86 **FCP170** SUMITOMO

2.5 D 51 08/93 → 08/96 **FCP765** AKEBONO

2.5 TD 64, 73 08/93 → 08/96 **FCP765** AKEBONO

Lancer

1.6 i 16V 72 09/03 → **FCP765** AKEBONO

2.0 Evo III 01/95 → 12/95 **FCP765** AKEBONO

2.0 Evo III 01/95 → 12/95 **FCP1283** AKEBONO

2.0 Evo IV 01/96 → 12/96 **FCP765** AKEBONO

2.0 Evo IV 01/96 → 12/96 **FCP1280** AKEBONO

2.0 Evo IX 01/05 → 11/07 **FCP1334** BREMBO

2.0 Evo IX 01/05 → 11/07 **FCP1562** BREMBO

2.0 Evo V 01/97 → 12/98 **FCP1334** BREMBO

2.0 Evo V 01/97 → 12/98 **FCP1562** BREMBO

2.0 Evo VI / Evo VII 206 01/99 → **FCP1562** ATE

2.0 Evo VI / Evo VII 206 01/99 → **FCP1334** BREMBO

2.0 Evo VI / Evo VII 206 01/99 → **FCP1562** BREMBO

2.0 Evo VI / Evo VII - gravel 206 01/99 → **FCP765** AKEBONO

2.0 Evo VI / Evo VII - gravel 206 01/99 → **FCP1280** AKEBONO

2.0 Evo VI / Evo VII - tarmac 206 01/99 → **FCP1334** BREMBO

2.0 Evo VI / Evo VII - tarmac 206 01/99 → **FCP1562** BREMBO

2.0 Evo VIII 195 03/04 → **FCP1334** BREMBO

2.0 Evo VIII 195 03/04 → **FCP1562** BREMBO

2.0 Evo VIII - Alcon FQ400 195 03/04 → **FRP3081** ALCON

2.0 Evo VIII - Alcon FQ400 195 03/04 → **FRP3082** ALCON

2.0i 16V 99 12/03 → **FCP765** AKEBONO

EVO IX-X Gr.N Asphalt 206 01/06 → **FRP3088** BREMBO

EVO IX-X Gr.N Asphalt 206 01/06 → **FRP308** BREMBO

EVO IX-X Gr.N Gravel 206 01/06 → **FRP3087** BREMBO

EVO IX-X Gr.N Gravel 206 01/06 → **FRP308** BREMBO

Ralliart 174 01/09 → **FCP765** AKEBONO

LANCER Saloon (CY/Z_A)

2.0 EVO X 221 06/08 → **FCP1334** BREMBO

2.0 EVO X 221 06/08 → **FCP4168** BREMBO

Montero

2.3 L034, L048 01/84 → 09/86 **FCP170** SUMITOMO

2.4 16V 82 04/91 → 08/94 **FCP765** AKEBONO

2.4 16V 82 04/91 → 08/94 **FCP1280** AKEBONO

2.5 TD 62 01/83 → 12/87 **FCP170** SUMITOMO

2.5 TD V24, V44 73 04/91 → 10/97 **FCP765** AKEBONO

2.5 TD V24, V44 73 04/91 → 10/97 **FCP1280** AKEBONO

2.8 TD V46 LWB 92 03/94 → **FCP765** AKEBONO

2.8 V24, V44 04/91 → 10/97 **FCP765** AKEBONO

2.8 V24, V44 04/91 → 10/97 **FCP1280** AKEBONO

3.0 TD V23 04/91 → 10/97 **FCP765** AKEBONO

3.0 TD V23 04/91 → 10/97 **FCP1280** AKEBONO

3.5 V25, V45 24V 143, 153 04/94 → 10/97 **FCP765** AKEBONO

Montero Sport

2.5 D 73 11/98 → **FCP765** AKEBONO

3.0 i 24V 130 11/98 → **FCP765** AKEBONO

MITSUBISHI

For material availability see page 16-18 / Per la disponibilità materiali vedere a pagina 16-18



KW

**...MITSUBISHI****Outlander**

2.0 i 4WD 16v	100	05/03 →	FCP765	AKEBONO
2.0 i Turbo 4WD 16v	148	04/04 →	FCP765	AKEBONO
2.4 i 4WD 16v	118	11/03 →	FCP765	AKEBONO

Pajero

2.3 TD L043	62	01/84 → 09/86	FCP170	SUMITOMO
2.3 TD L048	62	01/84 → 09/86	FCP170	SUMITOMO
2.4 (V21, 41) (II)	82	04/91 → 08/94	FCP765	AKEBONO
2.4 (V21, 41) (II)	82	04/91 → 08/94		FCP1280 AKEBONO
2.5 TD L044G	62	01/82 → 12/87	FCP170	SUMITOMO
2.5 TD L049GW	62	01/82 → 12/87	FCP170	SUMITOMO
2.5 TD V24, V44	73	04/91 →	FCP765	AKEBONO
2.5 TD V24, V44	73	04/91 →		FCP1280 AKEBONO
2.8 TD V46 LWB	92	01/93 → 12/00	FCP765	AKEBONO
2.8 V24, V44		04/91 →	FCP765	AKEBONO
2.8 V24, V44		04/91 →		FCP1280 AKEBONO
3.0 TD V6 (V23, 43) (II)		04/91 →	FCP765	AKEBONO
3.0 TD V6 (V23, 43) (II)		04/91 →		FCP1280 AKEBONO
3.5 V25, V45 24V	143, 153	04/94 → 12/00	FCP765	AKEBONO

PAJERO IV (V8_W, V9_W)

3.2 DI-D (V88W, V98W)	118	02/07 →	FCP1698	SUMITOMO
3.2 DI-D (V88W, V98W)	118	02/07 →		FCP1021 SUMITOMO
3.2 DI-D (V88W, V98W)	125	02/07 →	FCP1698	SUMITOMO
3.2 DI-D (V88W, V98W)	125	02/07 →		FCP1021 SUMITOMO
3.2 DI-D 4WD	140	02/07 →	FCP1698	SUMITOMO
3.2 DI-D 4WD	140	02/07 →		FCP1021 SUMITOMO
3.2 DI-D 4WD (V98W, V88W)	147	01/09 →	FCP1698	SUMITOMO
3.2 DI-D 4WD (V98W, V88W)	147	01/09 →		FCP1021 SUMITOMO
3.8 V6	182	02/10 →	FCP1698	SUMITOMO
3.8 V6	182	02/10 →		FCP1021 SUMITOMO
3.8 V6 (V87W, V97W)	184	02/07 →	FCP1698	SUMITOMO
3.8 V6 (V87W, V97W)	184	02/07 →		FCP1021 SUMITOMO

PAJERO IV Van (V90, V80)

3.2 DI-D	118	11/06 →	FCP1698	SUMITOMO
3.2 DI-D	118	11/06 →		FCP1021 SUMITOMO
3.2 TD 4WD	147	01/10 →	FCP1698	SUMITOMO
3.2 TD 4WD	147	01/10 →		FCP1021 SUMITOMO

Pajero Sport

2.5 D	73	11/98 →	FCP765	AKEBONO
3.0 i 24V	130	11/98 →	FCP765	AKEBONO

Sapporo

2.0 Coupe A123A, A164A		05/78 → 02/84	FCP170	SUMITOMO
------------------------	--	---------------	--------	----------

Shogun

2.3 TD L048 LWB		01/84 → 09/86	FCP170	SUMITOMO
2.4 i (V21/41) (II) 16V	82	01/91 → 08/94	FCP765	AKEBONO
2.5 TD V24, V44	73	04/91 →	FCP765	AKEBONO
2.5 TD V24, V44	73	04/91 →		FCP1280 AKEBONO
2.8 TD V46 LWB	92	03/94 →	FCP765	AKEBONO
2.8 TD V46 LWB	92	03/94 →		FCP1280 AKEBONO
2.8 V24, V44		04/91 →	FCP765	AKEBONO
2.8 V24, V44		04/91 →		FCP1280 AKEBONO
3.0 V23, V43		04/91 →	FCP765	AKEBONO
3.0 V23, V43		04/91 →		FCP1280 AKEBONO
3.5 V25, V45 24V	143, 153	04/94 →	FCP765	AKEBONO

Shogun Sport

2.5 D	73	03/00 →	FCP765	AKEBONO
3.0 i 24V	130	03/00 →	FCP765	AKEBONO

Sigma

1.6 i AV161 V SW Estate		01/80 → 12/81	FCP170	SUMITOMO
3.0 F16	130, 151	04/91 → 10/96	FCP765	AKEBONO

Space Star

1.3 16V	63	08/98 →	FCP1093	LUCAS/TRW
1.6 i 16V		09/01 →	FCP1093	LUCAS/TRW
1.8 16V	90	08/98 →	FCP1093	LUCAS/TRW
1.9 Di	75	02/01 →	FCP1093	LUCAS/TRW

For material availability see page 16-18 / Per la disponibilità materiali vedere a pagina 16-18

1138

FERODO

RACING

Updated on 17th Aug 2018

MITSUBISHI



KW



MORGAN					NOTE			NOTE
Four Four								
1.6 (Ford Engine)		01/68 → 01/86	FCP809	LUCAS/TRW				
Plus 8								
3.5 i V8 16V		03/84 → 05/90	FCP116	ATE				
3.5 V8 16V		01/66 → 12/73				FCP815	LUCAS/TRW	
3.5 V8 16V		01/83 → 03/84	FCP116	ATE				
NISSAN								
180 SX								
S13		01/96 → 01/99	FCP1430	SUMITOMO				
200SX (S13)								
1.8 S13 16V	124	04/89 → 09/91	FCP600	AKEBONO				
1.8 S13 16V	124	09/91 → 09/94	FCP691	SUMITOMO				
200SX (S14)								
2.0 i 16V Turbo	147	10/93 → 12/99	FCP986	SUMITOMO				
2.0 i 16V Turbo	147	10/93 → 12/99				FCP484	AKEBONO	
2.0 i S14 16V		10/94 → 05/01				FCP484	AKEBONO	
280ZX								
2.8 Fairlady (S130)		08/81 → 12/84				FCP484	AKEBONO	
300 ZX (Z32)								
3.0 Twin Turbo	197	05/90 → 09/95	FCP986	SUMITOMO				
3.0 Twin Turbo	208	05/90 → 09/95	FCP986	SUMITOMO				
300ZX (Z31)								
3.0 i		01/84 → 12/86				FCP484	AKEBONO	
3.0 i		01/87 → 08/87				FCP484	AKEBONO	
3.0 i		09/87 → 03/90				FCP484	AKEBONO	
350Z								
3.5 V6 24V	221	04/02 →	FCP1561	BREMBO				
3.5 V6 24V	221	04/02 →				FCP1562	BREMBO	
350Z		01/03 → 12/03	FCP1430	SUMITOMO				
350Z		01/03 → 12/03				FCP1693	AKEBONO	
Enthusiast / Touring / Grand Touring / Track		01/04 → 12/08	FCP1690	No BREMBO	Not 18" Wheels			
Enthusiast / Touring / Grand Touring / Track		01/04 → 12/08				FCP1693	AKEBONO	
370 Z								
3.7	241	06/09 →	FCP4172	AKEBONO				
3.7	241	06/09 →				FCP4173	AKEBONO	
Altima								
		01/93 → 12/01	FCP1430	SUMITOMO				
2.5 S / SL		01/06 → 12/06	FCP1430	SUMITOMO				
2.5 S / SL		01/06 → 12/06				FCP1693	AKEBONO	
3.5 SE / SL		01/06 → 12/06	FCP1430	SUMITOMO				
3.5 SE / SL		01/06 → 12/06				FCP1693	AKEBONO	
3.5 SE-R		01/06 → 12/06	FCP1786	SUMITOMO				
3.5 SE-R		01/06 → 12/06				FCP1693	AKEBONO	
Cherry								
1.0 i F10	33	01/77 → 12/79	FCP39	SUMITOMO				
1.0 N10	33, 37	11/78 → 04/82	FCP39	SUMITOMO				
1.2 N10	38	01/79 → 12/82	FCP39	SUMITOMO				
1.3 N10	44	11/78 → 04/82	FCP39	SUMITOMO				
1.4 N10	46	11/78 → 12/82	FCP39	SUMITOMO				
1.5 N10	51	11/78 → 12/82	FCP39	SUMITOMO				
Cherry Europe								
1.2 (RX920, ZX920)	46	01/83 → 12/85	FCP441	ATE				
1.2 (RX920, ZX920)	46	01/83 → 12/85	FCP72	BENDIX				
1.5 (RX920, ZX920)	69	01/83 → 12/85	FCP441	ATE				
1.5 (RX920, ZX920)	69	01/83 → 12/85	FCP72	BENDIX				

NISSAN

For material availability see page 16-18 / Per la disponibilità materiali vedere a pagina 16-18



KW



...NISSAN

Juke

1.5 dCi	81	06/10 →	FCP1430	SUMITOMO
1.6	86	06/10 →	FCP1430	SUMITOMO
1.6 DIG-T	140	06/10 →	FCP1430	SUMITOMO
1.6 DIG-T 4x4	140	06/10 →	FCP1430	SUMITOMO

Maxima

2.0	103	01/95 →	FCP1430	SUMITOMO
2.0	103	02/95 → 12/95	FCP691	SUMITOMO
3.0 J30	125	06/89 → 09/94	FCP691	SUMITOMO

Micra

1.0 K11 16V	40	01/93 → 09/00	FCP859	LUCAS/TRW
1.2 i K12 16V	59	01/03 →	FCP1617	LUCAS/TRW
1.3 K11 16V	55	01/93 → 09/00	FCP859	LUCAS/TRW
1.4 i 16V	60	09/00 → 01/03	FCP859	LUCAS/TRW
1.4 i K12 16V	65	01/03 →	FCP1617	LUCAS/TRW
1.5 D K11	42	05/98 → 01/03	FCP859	LUCAS/TRW
1.5 Dci K12 16V	48	01/03 →	FCP1617	LUCAS/TRW

NV400 Box

2.3 dCi	107	11/11 →	FCP4327	AKEB/SUMI
2.3 dCi	74	11/11 →	FCP4327	AKEB/SUMI
2.3 dCi	92	11/11 →	FCP4327	AKEB/SUMI
2.3 dCi	110	02/14 →	FCP4327	AKEB/SUMI
2.3 dCi	120	06/14 →	FCP4327	AKEB/SUMI
2.3 dCi	81	06/14 →	FCP4327	AKEB/SUMI
2.3 dCi [RWD]	107	11/11 →	FCP4327	AKEB/SUMI
2.3 dCi [RWD]	92	11/11 →	FCP4327	AKEB/SUMI
2.3 dCi [RWD]	100	06/14 →	FCP4327	AKEB/SUMI
2.3 dCi [RWD]	110	02/14 →	FCP4327	AKEB/SUMI
2.3 dCi [RWD]	120	06/14 →	FCP4327	AKEB/SUMI

NV400 Bus

2.3 dCi	107	11/11 →	FCP4327	AKEB/SUMI
2.3 dCi	74	11/11 →	FCP4327	AKEB/SUMI
2.3 dCi	92	11/11 →	FCP4327	AKEB/SUMI
2.3 dCi	100	06/14 →	FCP4327	AKEB/SUMI
2.3 dCi	110	02/14 →	FCP4327	AKEB/SUMI
2.3 dCi	120	06/14 →	FCP4327	AKEB/SUMI
2.3 dCi	81	06/14 →	FCP4327	AKEB/SUMI

NV400 Platform/Chassis

2.3 dCi	107	11/11 →	FCP4327	AKEB/SUMI
2.3 dCi	74	11/11 →	FCP4327	AKEB/SUMI
2.3 dCi	92	11/11 →	FCP4327	AKEB/SUMI
2.3 dCi	110	08/14 →	FCP4327	AKEB/SUMI
2.3 dCi	120	06/14 →	FCP4327	AKEB/SUMI
2.3 dCi [RWD]	107	11/11 →	FCP4327	AKEB/SUMI
2.3 dCi [RWD]	92	11/11 →	FCP4327	AKEB/SUMI
2.3 dCi [RWD]	100	06/14 →	FCP4327	AKEB/SUMI
2.3 dCi [RWD]	110	08/14 →	FCP4327	AKEB/SUMI
2.3 dCi [RWD]	120	06/14 →	FCP4327	AKEB/SUMI

Prairie

2.0 KA24E		01/92 → 12/93	FCP600	AKEBONO
2.0 M11	66	04/89 → 12/91	FCP600	AKEBONO
2.0 M11	77	04/89 → 12/91	FCP600	AKEBONO
2.0 M11	85	04/89 → 12/91	FCP600	AKEBONO
2.4 KA24E	93	01/92 → 12/93	FCP600	AKEBONO

PRAIRIE PRO (M11)

2.0 i	72	10/88 → 04/92	FCP600	AKEBONO
-------	----	---------------	--------	---------

Primera

1.6 i P12	78	03/02 →			FCP1540	ATE
1.6 W10 SW Estate 16V	66, 75	01/90 → 10/96	FCP600	AKEBONO		
1.8 i P12	85	03/02 →			FCP1540	ATE
1.9 dCi P12	88	03/03 →			FCP1540	ATE
2.0 D W10 SW Estate	55	01/92 → 03/98	FCP600	AKEBONO		
2.0 D W10 SW Estate	55	01/90 → 10/96	FCP600	AKEBONO		
2.0 i P12	103	03/02 →			FCP1540	ATE
2.0 i P12 SW Estate	103	03/02 →			FCP1540	ATE
2.0 W10 Petrol SW Estate 16V	85	01/90 → 04/93	FCP600	AKEBONO		
2.2 dCi P12	102	03/03 →			FCP1540	ATE
2.2 TD Di P12	93	03/02 →			FCP1540	ATE

For material availability see page 16-18 / Per la disponibilità materiali vedere a pagina 16-18

1140

FERODO

RACING

Updated on 17th Aug 2018

NISSAN



KW



...NISSAN

Silvia

1.8 i S12 (180ZX) (Turbo)	01/83 → 12/86		
1.8 i S12 (180ZX) (Turbo)	01/87 → 12/89		
2.0 i S12 (200ZX)	01/83 → 12/89		
2.0 i S14 (200SX) (Turbo) 16V	04/94 →		
S15, S13	01/99 →	FCP1430	SUMITOMO

Skyline

GT-R (R35)	357 01/08 →	FRP3106	BREMBO
GT-R (R35)	357 01/08 →		
GT-R (R35)	390 02/11 →	FRP3106	BREMBO
GT-R (R35)	390 02/11 →		
R32 / R33 GTS	01/89 → 12/98	FCP986	SUMITOMO
R33 GTR / R34	01/98 → 12/02	FCP1298	BREMBO

Sunny

1.2 B110	01/71 → 12/73	FCP39	SUMITOMO
1.2 B210 (120Y)	38 01/73 → 12/75	FCP39	SUMITOMO

Teana I (J31)

2.0	103 10/03 → 06/08	FCP1430	SUMITOMO
3.5	170 10/03 → 06/08	FCP1430	SUMITOMO

Tiida (C11X&SC11X)

1.5	78 09/07 →	FCP1430	SUMITOMO
1.6	81 09/07 →	FCP1430	SUMITOMO
1.8	93 09/07 →	FCP1430	SUMITOMO

Tiida Hatchback

1.5	80 05/04 → 02/07	FCP1430	SUMITOMO
-----	------------------	---------	----------

NSU

Prinz

	22 01/61 → 12/70	FCP3	ATE
--	------------------	------	-----

Spider

Wankel	37 01/64 → 12/67	FCP3	ATE
--------	------------------	------	-----

OLDSMOBILE

Eighty Eight

	01/74 → 12/85	FRP3057	KELGATE
--	---------------	---------	---------

Ninety Eight

	01/74 → 12/89	FRP3057	KELGATE
--	---------------	---------	---------

Omega

	01/75 → 12/79	FRP3057	KELGATE
--	---------------	---------	---------

Toronado

6.6 16V	105 01/72 → 12/78	FRP3057	KELGATE
7.5 16V	140 01/72 → 12/78	FRP3057	KELGATE

OPEL

ADAM

1.4 S	110 11/14 →	FCP1640	ATE	For PR Number J79		
1.4 S	110 11/14 →	FCP1466	BOSCH	For PR Number JQ3, JQ4		
1.4 S	110 11/14 →				FCP1858	LUCAS/TRW
Rallye Cup	01/12 →	FCP1667				
Rallye Cup	01/12 →				FCP1858	
Rallye R2	01/14 →	FRP501				
Rallye R2	01/14 →				FCP1858	

OPEL

For material availability see page 16-18 / Per la disponibilità materiali vedere a pagina 16-18



KW



...OPEL

Admiral

2.8 E	118	01/68	→ 12/73	FCP11	ATE
2.8 E	118	01/68	→ 12/73	FCP11	ATE
2.8 S	97, 103	01/64	→ 12/73	FCP11	ATE
2.8 S	97, 103	01/64	→ 12/73	FCP11	ATE

Ascona (A)

1.6		01/70	→ 12/75	FCP2	ATE
1.6 i		01/73	→ 12/75	FCP2	ATE
1.6 i S, Auto	51, 62	01/73	→ 12/75	FCP2	ATE
1.9	55, 66	01/70	→ 12/75	FCP2	ATE
1.9 i	55, 66	01/73	→ 12/75	FCP2	ATE

Ascona (B)

1.1		01/78	→ 12/81	FCP173	GM
1.2	40, 44	09/75	→ 08/78	FCP116	ATE
1.2	40, 44	09/78	→ 07/81	FCP173	GM
1.3	44, 55	07/75	→ 08/78	FCP116	ATE
1.3	44, 55	09/78	→ 07/81	FCP173	GM
1.6	44, 55	07/75	→ 08/78	FCP116	ATE
1.6	44, 55	09/78	→ 07/81	FCP173	GM
1.9	55, 66	07/75	→ 08/78	FCP116	ATE
1.9	55, 66	09/78	→ 07/81	FCP173	GM
2.0	66, 74	07/75	→ 08/78	FCP116	ATE

Ascona (C)

1.3	44, 55	08/81	→ 12/88	FCP173	GM
1.3	44, 55	12/83	→ 12/88	FCP173	GM
1.6	55	08/81	→ 12/88	FCP173	GM
1.6	55, 60	12/83	→ 12/88	FCP173	GM
1.8	85	08/81	→ 12/83	FCP173	GM
1.8	62	12/83	→ 12/88	FCP173	GM
1.8	74	12/83	→ 12/88	FCP173	GM
1.8	85	12/83	→ 12/88	FCP173	GM
2.0	81	01/81	→ 12/89	FCP173	GM
2.0	85	08/82	→ 12/88	FCP173	GM
2.0 GT Sport	95	12/83	→ 02/89	FCP173	GM

ASCONA B (81_, 86_, 87_, 88_)

2.0 D	43	08/78	→ 08/81	FCP173	GM
2.0 E	81	08/79	→ 08/81	FCP173	GM
2.0 N	66	08/77	→ 08/81	FCP173	GM
2.0 S	74	08/77	→ 08/81	FCP173	GM

Astra

1.4	40, 60	09/91	→ 02/98	FCP732	ATE
1.4	40, 60	09/91	→ 02/98	FCP584	ATE ABS
1.4 16V	66	09/91	→ 02/98	FCP732	ATE
1.4 16V	66	09/91	→ 02/98	FCP584	ATE ABS
1.4 i F	40, 60	01/94	→ 02/98	FCP732	ATE
1.4 i F 16V	66	01/94	→ 02/98	FCP732	ATE
1.4 i SW Estate F 16V	66	01/96	→ 02/98	FCP732	ATE
1.4 i SW Estate F 16V	66	01/96	→ 02/98	FCP584	ATE
1.4 SW Estate	40, 60	09/91	→ 02/98	FCP732	ATE
1.4 SW Estate	40, 60	09/91	→ 02/98	FCP584	ATE ABS
1.4 SW Estate 16V	66	09/91	→ 02/98	FCP732	ATE
1.4 SW Estate 16V	66	09/91	→ 02/98	FCP584	ATE ABS
1.6	52	09/91	→ 02/98	FCP732	ATE
1.6	52	09/91	→ 02/98	FCP584	ATE ABS
1.6	55	09/91	→ 02/98	FCP732	ATE
1.6	55	09/91	→ 02/98	FCP584	ATE ABS
1.6	74	09/91	→ 02/98	FCP732	ATE
1.6	74	09/91	→ 02/98	FCP584	ATE ABS
1.6 SW Estate	52	09/91	→ 02/98	FCP732	ATE
1.6 SW Estate	52	09/91	→ 02/98	FCP584	ATE ABS
1.6 SW Estate	55	09/91	→ 02/98	FCP732	ATE
1.6 SW Estate	55	09/91	→ 02/98	FCP584	ATE ABS
1.6 SW Estate	74	09/91	→ 02/98	FCP732	ATE
1.6 SW Estate	74	09/91	→ 02/98	FCP584	ATE ABS
1.7 D F	42, 44	01/94	→ 02/98	FCP732	ATE
1.7 D F	42, 44	09/91	→ 02/98	FCP732	ATE
1.7 D F	42, 44	09/91	→ 02/98	FCP584	ATE ABS
1.7 D F SW Estate	42, 44	09/91	→ 02/98	FCP732	ATE
1.7 D F SW Estate	42, 44	09/91	→ 02/98	FCP584	ATE ABS
1.7 TD F	50	01/94	→ 02/98	FCP732	ATE
1.7 TD F	50	01/94	→ 02/98	FCP584	ATE
1.7 TD F	50	09/91	→ 02/98	FCP732	ATE

For material availability see page 16-18 / Per la disponibilità materiali vedere a pagina 16-18

1142

FERODO

RACING

Updated on 17th Aug 2018



KW

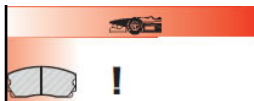

...OPEL

...Astra

Model	Year	From	To	Part	Brand	NOTE	Part	Brand	NOTE
1.7 TD F	50	09/91	→ 02/98	FCP584	ATE	ABS			
1.8 F	66, 92	09/91	→ 02/98	FCP732	ATE				
1.8 F	66, 92	09/91	→ 02/98	FCP584	ATE	ABS			
1.8 GSi 16V	92	09/91	→ 02/98	FCP584	ATE				
1.8 GSi 16V	92	09/91	→ 02/98				FCP586	ATE	
1.8 i F	66, 92	01/95	→ 02/98	FCP732	ATE				
1.8 i F	66, 92	01/95	→ 02/98	FCP584	ATE				
2.0 F	85, 100	09/91	→ 02/98	FCP584	ATE				
2.0 F	85, 100	09/91	→ 02/98				FCP586	ATE	

Astra G

1.4 16V	44	03/98	→ 05/01	FCP1293	ATE				
1.4 16V	44	03/98	→ 05/01				FCP1294	BOSCH	
1.4 16V	60	03/98	→ 05/01	FCP1293	ATE				
1.4 16V	60	03/98	→ 05/01				FCP1294	BOSCH	
1.4 16V	60	06/01	→ 03/04	FCP1293	ATE				
1.4 16V	60	06/01	→ 03/04				FCP1294	BOSCH	
1.4 16V	66	03/98	→ 05/01	FCP1293	ATE				
1.4 16V	66	03/98	→ 05/01				FCP1294	BOSCH	
1.4 16V	66	06/98	→ 07/04	FCP1293	ATE				
1.4 16V	66	06/98	→ 07/04				FCP1521	LUCAS/TRW	
1.4 16V	66	06/01	→ 03/04	FCP1293	ATE				
1.4 16V	66	06/01	→ 03/04				FCP1294	BOSCH	
1.6	55	02/98	→ 09/00	FCP1293	ATE				
1.6	55	02/98	→ 09/00				FCP1521	LUCAS/TRW	
1.6	55	03/98	→ 05/01	FCP1293	ATE				
1.6	55	03/98	→ 05/01				FCP1294	BOSCH	
1.6	55	06/01	→ 03/04	FCP1293	ATE				
1.6	55	06/01	→ 03/04				FCP1294	BOSCH	
1.6	74	03/98	→ 05/01	FCP1293	ATE				
1.6	74	03/98	→ 05/01				FCP1294	BOSCH	
1.7 TD	50	02/98	→ 08/00	FCP1293	ATE				
1.7 TD	50	02/98	→ 08/00				FCP1521	LUCAS/TRW	
1.7 TD	50	03/98	→ 05/01	FCP1293	ATE				
1.7 TD	50	03/98	→ 05/01				FCP1294	BOSCH	
1.7 TD	50	06/01	→ 03/04	FCP1293	ATE				
1.7 TD	50	06/01	→ 03/04				FCP1294	BOSCH	
1.7 TD	60	03/98	→ 05/01	FCP1293	ATE				
1.7 TD	60	03/98	→ 05/01				FCP1294	BOSCH	
1.8 16V	66	03/98	→ 05/01	FCP1295	ATE				
1.8 16V	66	03/98	→ 05/01				FCP1294	BOSCH	
1.8 16V	85	02/98	→ 09/00	FCP1293	ATE	256mm disc			
1.8 16V	85	02/98	→ 09/00	FCP1295	ATE	280mm disc			
1.8 16V	85	02/98	→ 09/00				FCP1521	LUCAS/TRW	
1.8 16V	85	03/98	→ 05/01	FCP1295	ATE				
1.8 16V	85	03/98	→ 05/01				FCP1294	BOSCH	
1.8 16V	85	06/01	→ 03/04	FCP1295	ATE				
1.8 16V	85	06/01	→ 03/04				FCP1294	BOSCH	
1.8 16V	92	03/98	→ 05/01	FCP1295	ATE				
1.8 16V	92	03/98	→ 05/01				FCP1294	BOSCH	
2.0 16V	100	02/98	→ 07/04	FCP1293	ATE	256mm disc			
2.0 16V	100	02/98	→ 07/04	FCP1295	ATE	280mm disc			
2.0 16V	100	02/98	→ 07/04				FCP1521	LUCAS/TRW	
2.0 16V	100	03/98	→ 05/01	FCP1295	ATE				
2.0 16V	100	03/98	→ 05/01				FCP1294	BOSCH	
2.0 16V	100	06/01	→ 03/04	FCP1295	ATE				
2.0 16V	100	06/01	→ 03/04				FCP1294	BOSCH	
2.0 16V	110	03/98	→ 05/01	FCP1295	ATE				
2.0 16V	110	03/98	→ 05/01				FCP1294	BOSCH	
2.0 16V	85	03/98	→ 05/01	FCP1295	ATE				
2.0 16V	85	03/98	→ 05/01				FCP1294	BOSCH	
2.0 DTi 16V	74	03/98	→ 05/01	FCP1295	ATE				
2.0 DTi 16V	74	03/98	→ 05/01				FCP1294	BOSCH	
2.0 DTi 16V	74	08/99	→ 07/04	FCP1293	ATE	256mm disc			
2.0 DTi 16V	74	08/99	→ 07/04	FCP1295	ATE	280mm disc			
2.0 DTi 16V	74	08/99	→ 07/04				FCP1521	LUCAS/TRW	
2.0 DTi 16V	74	06/01	→ 03/04	FCP1295	ATE				
2.0 DTi 16V	74	06/01	→ 03/04				FCP1294	BOSCH	

ASTRA G Box (F70)

1.6	55	01/99	→ 09/00	FCP1293	ATE				
1.6	55	01/99	→ 09/00				FCP1521	LUCAS/TRW	
1.6	62	09/00	→ 04/05	FCP1293	ATE	256mm disc			
1.6	62	09/00	→ 04/05	FCP1295	ATE	280mm disc			
1.6	62	09/00	→ 04/05				FCP1521	LUCAS/TRW	
1.7 TD	50	01/99	→ 04/05	FCP1293	ATE				
1.7 TD	50	01/99	→ 04/05				FCP1521	LUCAS/TRW	

For material availability see page 16-18 / Per la disponibilità materiali vedere a pagina 16-18



KW



...OPEL

...ASTRA G Box (F70)

2.0 DI	60	01/99	→ 04/05	FCP1293	ATE	256mm disc			
2.0 DI	60	01/99	→ 04/05	FCP1295	ATE	280mm disc			
2.0 DI	60	01/99	→ 04/05				FCP1521	LUCAS/TRW	

ASTRA G Convertible (F67)

1.6	76	01/03	→ 10/05	FCP1293	ATE				
1.6	76	01/03	→ 10/05				FCP1521	LUCAS/TRW	
1.6 16V	74	03/01	→ 10/05	FCP1293	ATE	256mm disc			
1.6 16V	74	03/01	→ 10/05	FCP1295	ATE	280mm disc			
1.6 16V	74	03/01	→ 10/05				FCP1521	LUCAS/TRW	
1.8 16V	92	03/01	→ 10/05	FCP1293	ATE	256mm disc			
1.8 16V	92	03/01	→ 10/05	FCP1295	ATE	280mm disc			
1.8 16V	92	03/01	→ 10/05				FCP1521	LUCAS/TRW	
2.0 16V Turbo	147	11/02	→ 10/05	FCP1068	ATE				
2.0 16V Turbo	147	11/02	→ 10/05				FCP1521	LUCAS/TRW	
2.0 OPC	141	03/02	→ 10/05	FCP1068	ATE				
2.0 OPC	141	03/02	→ 10/05				FCP1521	LUCAS/TRW	
2.2 16V	108	03/01	→ 10/05	FCP1295	ATE				
2.2 16V	108	03/01	→ 10/05				FCP1521	LUCAS/TRW	
2.2 DTI	92	09/02	→ 10/05	FCP1295	ATE				
2.2 DTI	92	09/02	→ 10/05				FCP1521	LUCAS/TRW	

ASTRA G Coupé (F07_)

1.6 16V	74	03/00	→ 05/05	FCP1293	ATE				
1.6 16V	74	03/00	→ 05/05				FCP1521	LUCAS/TRW	
1.6 16V	76	03/00	→ 05/05	FCP1293	ATE	256mm disc			
1.6 16V	76	03/00	→ 05/05	FCP1295	ATE	280mm disc			
1.6 16V	76	03/00	→ 05/05				FCP1521	LUCAS/TRW	
1.8 16V	85	03/00	→ 10/00	FCP1293	ATE	256mm disc			
1.8 16V	85	03/00	→ 10/00	FCP1295	ATE	280mm disc			
1.8 16V	85	03/00	→ 10/00				FCP1521	LUCAS/TRW	
1.8 16V	92	09/00	→ 05/05	FCP1295	ATE				
1.8 16V	92	09/00	→ 05/05				FCP1521	LUCAS/TRW	
2.0 16V Turbo	140	09/00	→ 08/01	FCP1068	ATE	280mm disc			
2.0 16V Turbo	140	09/00	→ 08/01	FCP1295	ATE	280mm disc			
2.0 16V Turbo	140	09/00	→ 08/01				FCP1521	LUCAS/TRW	
2.0 16V Turbo	141	06/01	→ 03/04	FCP1295	ATE				
2.0 16V Turbo	141	06/01	→ 03/04				FCP1294	BOSCH	
2.0 16V Turbo	141	08/01	→ 05/05	FCP1068	ATE	280mm disc			
2.0 16V Turbo	141	08/01	→ 05/05	FCP1295	ATE	280mm disc			
2.0 16V Turbo	141	08/01	→ 05/05				FCP1521	LUCAS/TRW	
2.0 16V Turbo	147	11/02	→ 05/05	FCP1068	ATE	280mm disc			
2.0 16V Turbo	147	11/02	→ 05/05	FCP1295	ATE	280mm disc			
2.0 16V Turbo	147	11/02	→ 05/05				FCP1521	LUCAS/TRW	
2.2 16V	108	09/00	→ 05/05	FCP1295	ATE				
2.2 16V	108	09/00	→ 05/05				FCP1521	LUCAS/TRW	
2.2 DTI	92	09/02	→ 05/05	FCP1295	ATE				
2.2 DTI	92	09/02	→ 05/05				FCP1521	LUCAS/TRW	

ASTRA G Estate (F35_)

1.2 16V	48	02/98	→ 09/00	FCP1293	ATE				
1.2 16V	48	02/98	→ 09/00				FCP1521	LUCAS/TRW	
1.2 16V	55	09/00	→ 07/04	FCP1293	ATE				
1.2 16V	55	09/00	→ 07/04				FCP1521	LUCAS/TRW	
1.4	66	09/07	→ 12/09	FCP1293	ATE				
1.4	66	09/07	→ 12/09				FCP1521	LUCAS/TRW	
1.6	62	09/00	→ 07/04	FCP1293	ATE				
1.6	62	09/00	→ 07/04				FCP1521	LUCAS/TRW	
1.6	62	06/01	→ 03/04	FCP1293	ATE				
1.6	62	06/01	→ 03/04				FCP1294	BOSCH	
1.6	76	12/02	→ 07/09	FCP1293	ATE				
1.6	76	12/02	→ 07/09				FCP1521	LUCAS/TRW	
1.6 16V	74	02/98	→ 07/04	FCP1293	ATE	256mm disc			
1.6 16V	74	02/98	→ 07/04	FCP1295	ATE	280mm disc			
1.6 16V	74	02/98	→ 07/04				FCP1521	LUCAS/TRW	
1.6 CNG	71	03/03	→ 07/04	FCP1293	ATE	256mm disc			
1.6 CNG	71	03/03	→ 07/04	FCP1295	ATE	280mm disc			
1.6 CNG	71	03/03	→ 07/04				FCP1521	LUCAS/TRW	
1.7 CDTI	59	04/03	→ 07/09	FCP1293	ATE				
1.7 CDTI	59	04/03	→ 07/09				FCP1521	LUCAS/TRW	
1.7 DTI 16V	55	02/00	→ 07/04	FCP1293	ATE				
1.7 DTI 16V	55	02/00	→ 07/04				FCP1521	LUCAS/TRW	
1.8 16V	92	09/00	→ 07/04	FCP1293	ATE	256mm disc			
1.8 16V	92	09/00	→ 07/04	FCP1295	ATE	280mm disc			
1.8 16V	92	09/00	→ 07/04				FCP1521	LUCAS/TRW	
1.8 16V	92	06/01	→ 03/04	FCP1295	ATE				
1.8 16V	92	06/01	→ 03/04				FCP1294	BOSCH	

For material availability see page 16-18 / Per la disponibilità materiali vedere a pagina 16-18



KW

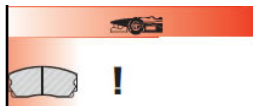

...OPEL

...ASTRA G Saloon (F69_)

					NOTE			NOTE
1.6	62	09/00 → 01/05	FCP1293	ATE				
1.6	62	09/00 → 01/05				FCP1521	LUCAS/TRW	
1.6	76	12/02 → 01/05	FCP1293	ATE				
1.6	76	12/02 → 01/05				FCP1521	LUCAS/TRW	
1.6 16V	74	09/98 → 01/05	FCP1293	ATE	256mm disc			
1.6 16V	74	09/98 → 01/05	FCP1295	ATE	280mm disc			
1.6 16V	74	09/98 → 01/05				FCP1521	LUCAS/TRW	
1.7 CDTI	59	04/03 → 01/05	FCP1293	ATE				
1.7 CDTI	59	04/03 → 01/05				FCP1521	LUCAS/TRW	
1.7 DTI 16V	55	02/00 → 01/05	FCP1293	ATE				
1.7 DTI 16V	55	02/00 → 01/05				FCP1521	LUCAS/TRW	
1.7 TD	50	09/98 → 08/00	FCP1293	ATE				
1.7 TD	50	09/98 → 08/00				FCP1521	LUCAS/TRW	
1.8 16V	85	09/98 → 09/00	FCP1293	ATE	256mm disc			
1.8 16V	85	09/98 → 09/00	FCP1295	ATE	280mm disc			
1.8 16V	85	09/98 → 09/00				FCP1521	LUCAS/TRW	
1.8 16V	92	06/00 → 01/05	FCP1293	ATE	256mm disc			
1.8 16V	92	06/00 → 01/05	FCP1295	ATE	280mm disc			
1.8 16V	92	06/00 → 01/05				FCP1521	LUCAS/TRW	
2.0 16V	100	09/98 → 01/05	FCP1293	ATE	256mm disc			
2.0 16V	100	09/98 → 01/05	FCP1295	ATE	280mm disc			
2.0 16V	100	09/98 → 01/05				FCP1521	LUCAS/TRW	
2.0 DI	60	09/98 → 01/05	FCP1293	ATE	256mm disc			
2.0 DI	60	09/98 → 01/05	FCP1295	ATE	280mm disc			
2.0 DI	60	09/98 → 01/05				FCP1521	LUCAS/TRW	
2.0 DTI 16V	74	08/99 → 01/05	FCP1293	ATE	256mm disc			
2.0 DTI 16V	74	08/99 → 01/05	FCP1295	ATE	280mm disc			
2.0 DTI 16V	74	08/99 → 01/05				FCP1521	LUCAS/TRW	
2.2 16V	108	03/01 → 01/05	FCP1295	ATE				
2.2 16V	108	03/01 → 01/05				FCP1521	LUCAS/TRW	
2.2 DTI	86	09/02 → 01/05	FCP1295	ATE				
2.2 DTI	86	09/02 → 01/05				FCP1521	LUCAS/TRW	
2.2 DTI	92	09/02 → 01/05	FCP1295	ATE				
2.2 DTI	92	09/02 → 01/05				FCP1521	LUCAS/TRW	

ASTRA H (L48)

1.2	59	08/05 →	FCP1640	ATE				
1.2	59	08/05 →				FCP1521	LUCAS/TRW	
1.3 CDTI	66	08/05 →	FCP1640	ATE				
1.3 CDTI	66	08/05 →				FCP1521	LUCAS/TRW	
1.4	55	04/04 → 10/04	FCP1640	ATE				
1.4	55	04/04 → 10/04				FCP1521	LUCAS/TRW	
1.4	59	04/04 → 10/04	FCP1640	ATE				
1.4	59	04/04 → 10/04				FCP1521	LUCAS/TRW	
1.4	66	03/04 →	FCP1640	ATE				
1.4	66	03/04 →				FCP1521	LUCAS/TRW	
1.4 LPG	66	08/09 →	FCP1640	ATE				
1.4 LPG	66	08/09 →				FCP1521	LUCAS/TRW	
1.6	77	03/04 →	FCP1640	ATE				
1.6	77	03/04 →				FCP1521	LUCAS/TRW	
1.6	85	12/06 →	FCP1640	ATE				
1.6	85	12/06 →				FCP1521	LUCAS/TRW	
1.6 Turbo	132	02/07 →	FCP1640	ATE				
1.6 Turbo	132	02/07 →				FCP1521	LUCAS/TRW	
1.7 CDTI	59	03/04 →	FCP1640	ATE				
1.7 CDTI	59	03/04 →				FCP1521	LUCAS/TRW	
1.7 CDTI	74	03/04 →	FCP1640	ATE				
1.7 CDTI	74	03/04 →				FCP1521	LUCAS/TRW	
1.7 CDTI	81	02/07 →	FCP1640	ATE				
1.7 CDTI	81	02/07 →				FCP1521	LUCAS/TRW	
1.7 CDTI	92	02/07 →	FCP1640	ATE				
1.7 CDTI	92	02/07 →				FCP1521	LUCAS/TRW	
1.8	103	01/06 →	FCP1640	ATE				
1.8	103	01/06 →				FCP1521	LUCAS/TRW	
1.8	92	03/04 →	FCP1640	ATE				
1.8	92	03/04 →				FCP1521	LUCAS/TRW	
1.9 CDTI	110	09/04 →	FCP1640	ATE				
1.9 CDTI	110	09/04 →				FCP1521	LUCAS/TRW	
1.9 CDTI	74	09/05 →	FCP1640	ATE				
1.9 CDTI	74	09/05 →				FCP1521	LUCAS/TRW	
1.9 CDTI	88	06/04 →	FCP1640	ATE				
1.9 CDTI	88	06/04 →				FCP1521	LUCAS/TRW	
1.9 CDTI 16V	88	04/04 →	FCP1640	ATE				
1.9 CDTI 16V	88	04/04 →				FCP1521	LUCAS/TRW	
2.0 Turbo	125	03/04 →	FCP1640	ATE				
2.0 Turbo	125	03/04 →				FCP1521	LUCAS/TRW	
2.0 Turbo	147	09/04 →	FCP1640	ATE				

For material availability see page 16-18 / Per la disponibilità materiali vedere a pagina 16-18



KW



...OPEL

...ASTRA H (L48)

2.0 Turbo	147	09/04	→
2.0 Turbo	177	03/05	→
2.0 Turbo	177	03/05	→

FCP1520

ATE

FCP1521

LUCAS/TRW

ASTRA H Estate (L35)

1.3 CDTI	66	08/05	→
1.3 CDTI	66	08/05	→
1.4	55	08/04	→
1.4	55	08/04	→
1.4	66	08/04	→
1.4	66	08/04	→
1.4 LPG	66	08/09	→
1.4 LPG	66	08/09	→
1.6	77	08/04	→
1.6	77	08/04	→
1.6	85	12/06	→
1.6	85	12/06	→
1.6 LPG	85	08/09	→
1.6 LPG	85	08/09	→
1.6 Turbo	132	02/07	→
1.6 Turbo	132	02/07	→
1.7 CDTI	59	08/04	→
1.7 CDTI	59	08/04	→
1.7 CDTI	74	08/04	→
1.7 CDTI	74	08/04	→
1.7 CDTI	81	02/07	→
1.7 CDTI	81	02/07	→
1.7 CDTI	92	02/07	→
1.7 CDTI	92	02/07	→
1.8	103	08/05	→
1.8	103	08/05	→
1.8	92	08/04	→
1.8	92	08/04	→
1.9 CDTI	110	09/04	→
1.9 CDTI	110	09/04	→
1.9 CDTI	74	09/05	→
1.9 CDTI	74	09/05	→
1.9 CDTI	88	09/05	→
1.9 CDTI	88	09/05	→
1.9 CDTI 16V	88	08/04	→
1.9 CDTI 16V	88	08/04	→
2.0 Turbo	125	08/04	→
2.0 Turbo	125	08/04	→
2.0 Turbo	147	09/04	→
2.0 Turbo	147	09/04	→

FCP1640

ATE

FCP1521

LUCAS/TRW

ASTRA H GTC (L08)

1.2	59	08/05	→
1.2	59	08/05	→
1.3 CDTI	66	04/05	→
1.3 CDTI	66	04/05	→
1.4	55	03/05	→
1.4	55	03/05	→
1.4	66	03/05	→
1.4	66	03/05	→
1.6	77	03/05	→
1.6	77	03/05	→
1.6	85	12/06	→
1.6	85	12/06	→
1.6 Turbo	132	02/07	→
1.6 Turbo	132	02/07	→
1.7 CDTI	59	03/05	→
1.7 CDTI	59	03/05	→
1.7 CDTi	74	03/05	→
1.7 CDTi	74	03/05	→
1.7 CDTI	81	02/07	→
1.7 CDTI	81	02/07	→
1.7 CDTI	92	02/07	→
1.7 CDTI	92	02/07	→
1.8	103	01/06	→
1.8	103	01/06	→
1.8	92	03/05	→
1.8	92	03/05	→
1.9 CDTi	110	03/05	→
1.9 CDTi	110	03/05	→
1.9 CDTI	74	01/06	→
1.9 CDTI	74	01/06	→

FCP1640

ATE

FCP1521

LUCAS/TRW

NOTE

NOTE

For material availability see page 16-18 / Per la disponibilità materiali vedere a pagina 16-18



KW



OPEL

...OPEL

...ASTRA H GTC (L08)

					NOTE			NOTE
1.9 CDTI	88	09/05 →	FCP1640	ATE				
1.9 CDTI	88	09/05 →				FCP1521	LUCAS/TRW	
1.9 CDTi 16V	88	03/05 →	FCP1640	ATE				
1.9 CDTi 16V	88	03/05 →				FCP1521	LUCAS/TRW	
2.0 Turbo	125	03/05 →	FCP1640	ATE				
2.0 Turbo	125	03/05 →				FCP1521	LUCAS/TRW	
2.0 Turbo	147	03/05 →	FCP1640	ATE				
2.0 Turbo	147	03/05 →				FCP1521	LUCAS/TRW	
2.0 Turbo	177	08/05 →	FCP1520	ATE				
2.0 Turbo	177	08/05 →				FCP1521	LUCAS/TRW	

ASTRA H Saloon (L69)

1.3 CDTi	66	02/07 →	FCP1640	ATE				
1.3 CDTi	66	02/07 →				FCP1521	LUCAS/TRW	
1.6	85	02/07 →	FCP1640	ATE				
1.6	85	02/07 →				FCP1521	LUCAS/TRW	
1.7 CDTi	74	02/07 →	FCP1640	ATE				
1.7 CDTi	74	02/07 →				FCP1521	LUCAS/TRW	
1.7 CDTi	81	02/07 →	FCP1640	ATE				
1.7 CDTi	81	02/07 →				FCP1521	LUCAS/TRW	
1.8	103	02/07 →	FCP1640	ATE				
1.8	103	02/07 →				FCP1521	LUCAS/TRW	

ASTRA H TwinTop (L67)

1.6	77	09/05 →	FCP1640	ATE				
1.6	77	09/05 →				FCP1521	LUCAS/TRW	
1.6	85	12/06 →	FCP1640	ATE				
1.6	85	12/06 →				FCP1521	LUCAS/TRW	
1.6 Turbo	132	02/07 →	FCP1640	ATE				
1.6 Turbo	132	02/07 →				FCP1521	LUCAS/TRW	
1.8	103	09/05 →	FCP1640	ATE				
1.8	103	09/05 →				FCP1521	LUCAS/TRW	
1.8	92	09/05 →	FCP1640	ATE				
1.8	92	09/05 →				FCP1521	LUCAS/TRW	
1.9 CDTi	110	09/05 →	FCP1640	ATE				
1.9 CDTi	110	09/05 →				FCP1521	LUCAS/TRW	
2.0 Turbo	125	09/05 →	FCP1640	ATE				
2.0 Turbo	125	09/05 →				FCP1521	LUCAS/TRW	
2.0 Turbo	147	09/05 →	FCP1640	ATE				
2.0 Turbo	147	09/05 →				FCP1521	LUCAS/TRW	

ASTRA H Van (L70)

1.3 CDTI	66	08/05 →	FCP1640	ATE				
1.3 CDTI	66	08/05 →				FCP1521	LUCAS/TRW	
1.6	76	02/04 → 11/04	FCP1640	ATE				
1.7 CDTI	74	03/04 →	FCP1640	ATE				
1.7 CDTI	74	03/04 →				FCP1521	LUCAS/TRW	
1.7 CDTI	81	02/07 →	FCP1640	ATE				
1.7 CDTI	81	02/07 →				FCP1521	LUCAS/TRW	
1.7 CDTI	92	02/07 →	FCP1640	ATE				
1.7 CDTI	92	02/07 →				FCP1521	LUCAS/TRW	
1.9 CDTI	110	09/04 →	FCP1640	ATE				
1.9 CDTI	110	09/04 →				FCP1521	LUCAS/TRW	
1.9 CDTI	88	09/05 →	FCP1640	ATE				
1.9 CDTI	88	09/05 →				FCP1521	LUCAS/TRW	
1.9 CDTI 16V	88	08/04 →	FCP1640	ATE				
1.9 CDTI 16V	88	08/04 →				FCP1521	LUCAS/TRW	

ASTRA J (P10)

1.3 CDTI	70	12/09 →	FCP4262	MANDO				
1.4	64	12/09 →	FCP4262	MANDO	Disc Diam mm:276			
1.4	74	12/09 →	FCP4262	MANDO	Disc Diam mm:276			
1.4 LPG	103	01/12 →	FCP4262	MANDO	Disc Diam mm:276			
1.4 Turbo	103	12/09 →	FCP4262	MANDO				
1.4 Turbo	88	10/10 →	FCP4262	MANDO	Disc Diam mm:276			
1.6	85	12/09 →	FCP4262	MANDO	Disc Diam mm:276			
1.6 CDTi	100	01/14 →	FCP4262	MANDO	Disc Diam mm:276			
1.6 CDTi	81	02/14 →	FCP4262	MANDO	Disc Diam mm:276			
1.6 SIDI	125	12/12 →	FCP1334	BREMBO	Disc Diam mm:276			
1.6 SIDI	125	12/12 →	FCP4262	MANDO	Disc Diam mm:276			
1.6 Turbo	132	12/09 →	FCP4262	MANDO				
1.7 CDTI	74	10/10 →	FCP4262	MANDO				
1.7 CDTI	81	12/09 →	FCP4262	MANDO				
1.7 CDTI	92	12/09 →	FCP4262	MANDO				
1.7 CDTI	96	12/09 →	FCP4262	MANDO	Disc Diam mm:276			
2.0 Biturbo CDTI	143	12/12 →	FCP4262	MANDO	Disc Diam mm:276			
2.0 Biturbo CDTI	143	12/12 →	FCP1334	BREMBO	Disc Diam mm:276			

For material availability see page 16-18 / Per la disponibilità materiali vedere a pagina 16-18



KW

**...OPEL****...ASTRA J (P10)**

2.0 CDTI	118	12/09 →	FCP4262	MANDO	For 276mm Discs		
2.0 CDTI	121	06/11 →	FCP4262	MANDO	Disc Diam mm:276		

ASTRA J GTC

1.6 CDTI	100	07/14 →	FCP4262	MANDO	Disc Diam mm:276		
1.6 CDTI	81	07/14 →	FCP4262	MANDO	Disc Diam mm:276		
1.6 SIDI	125	12/12 →	FCP4262	MANDO	Disc Diam mm:276		
1.6 SIDI	125	12/12 →	FCP1334	BREMBO	Disc Diam mm:276		
1.6 SIDI	147	07/13 →	FCP4262	MANDO	Disc Diam mm:276		
1.6 SIDI	147	07/13 →	FCP1334	BREMBO	Disc Diam mm:276		
2.0 BiTurbo CDTI	143	10/12 →	FCP4262	MANDO	Disc Diam mm:276		
2.0 BiTurbo CDTI	143	10/12 →	FCP1334	BREMBO	Disc Diam mm:276		

ASTRA J Saloon

1.3 CDTI	70	06/12 →	FCP4262	MANDO	Disc Diam mm:276		
1.4	74	06/12 →	FCP4262	MANDO	Disc Diam mm:276		
1.4 LPG	103	07/14 →	FCP4262	MANDO	Disc Diam mm:276		
1.4 Turbo	103	06/12 →	FCP4262	MANDO	Disc Diam mm:276		
1.6	85	06/12 →	FCP4262	MANDO	Disc Diam mm:276		
1.6 CDTi	100	01/14 →	FCP4262	MANDO	Disc Diam mm:276		
1.6 CDTi	81	04/14 →	FCP4262	MANDO	Disc Diam mm:276		
1.6 SIDI	125	12/12 →	FCP4262	MANDO	Disc Diam mm:276		
1.6 SIDI	125	12/12 →	FCP1334	BREMBO	Disc Diam mm:276		
1.6 Turbo	132	06/12 →	FCP4262	MANDO	Disc Diam mm:276		
1.7 CDTI	81	06/12 →	FCP4262	MANDO	Disc Diam mm:276		
1.7 CDTI	96	06/12 →	FCP4262	MANDO	Disc Diam mm:276		

ASTRA J Sports Tourer (P10)

1.3 CDTI	70	10/10 →	FCP4262	MANDO	Disc Diam mm:276		
1.4	64	10/10 → 10/15	FCP4262	MANDO	Disc Diam mm:276		
1.4	74	10/10 →	FCP4262	MANDO			
1.4 LPG	103	01/12 →	FCP4262	MANDO	Disc Diam mm:276		
1.4 Turbo	103	10/10 →	FCP4262	MANDO			
1.4 Turbo	88	10/10 →	FCP4262	MANDO	Disc Diam mm:276		
1.6	85	10/10 →	FCP4262	MANDO	Disc Diam mm:276		
1.6 CDTi	100	01/14 →	FCP4262	MANDO	Disc Diam mm:276		
1.6 CDTi	81	02/14 →	FCP4262	MANDO	Disc Diam mm:276		
1.6 SIDI	125	12/12 →	FCP4262	MANDO	Disc Diam mm:276		
1.6 SIDI	125	12/12 →	FCP1334	BREMBO	Disc Diam mm:276		
1.6 Turbo	132	10/10 →	FCP4262	MANDO			
1.7 CDTI	74	10/10 →	FCP4262	MANDO	Disc Diam mm:276		
1.7 CDTI	81	10/10 →	FCP4262	MANDO			
1.7 CDTI	92	10/10 →	FCP4262	MANDO			
1.7 CDTI	96	10/10 →	FCP4262	MANDO	Disc Diam mm:276		
2.0 BiTurbo CDTI	143	12/12 →	FCP4262	MANDO	Disc Diam mm:276		
2.0 BiTurbo CDTI	143	12/12 →	FCP1334	BREMBO	Disc Diam mm:276		
2.0 CDTI	118	10/10 →	FCP4262	MANDO	Disc Diam mm:276		
2.0 CDTI	121	08/11 →	FCP4262	MANDO	Disc Diam mm:276		
2.0 CDTI	96	10/10 →	FCP4262	MANDO	Disc Diam mm:276		

Calibra

2.0	85	09/89 → 12/96	FCP584	ATE			
2.0	85	09/89 → 12/96				FCP586	ATE
2.0 (Turbo) 16V	150	09/89 → 12/96	FCP685	ATE			
2.0 (Turbo) 16V	150	09/89 → 12/96				FCP586	ATE
2.0 i Turbo 16V	150	01/95 → 12/96				FCP586	ATE
2.5 24V	125	09/89 → 12/94	FCP685	ATE			
2.5 24V	125	09/89 → 12/94				FCP586	ATE
2.5 24V	125	01/95 → 05/98	FCP1068	ATE			
2.5 24V	125	01/95 → 05/98				FCP586	ATE

COMBO

1.2	33	07/94 →	FCP732	ATE			
1.2 E		08/84 →	FCP732	ATE			
1.4	44, 60	07/94 →	FCP732	ATE			
1.7 D		08/84 →	FCP732	ATE			
1.7 D	44	07/94 →	FCP732	ATE			

COMBO Box Body / Estate

1.2 i 16V	55	09/00 →	FCP1424	LUCAS/TRW			
1.3 CDTI 16V	51	08/05 →	FCP1640	ATE			
1.3 CDTI 16V	51	08/05 →				FCP1521	LUCAS/TRW
1.3 CDTI 16V	55	10/05 →	FCP1640	ATE			
1.3 CDTI 16V	55	10/05 →				FCP1521	LUCAS/TRW
1.4 i 16V	66	09/00 →	FCP1424	LUCAS/TRW			
1.4 i 16V	66	08/05 →	FCP1640	ATE			

For material availability see page 16-18 / Per la disponibilità materiali vedere a pagina 16-18



KW



...OPEL

...COMBO Box Body / Estate

					NOTE			NOTE
1.4 i 16V	66	08/05 →				FCP1521	LUCAS/TRW	
1.6	64	10/01 →	FCP1424	LUCAS/TRW				
1.6	64	10/01 →	FCP1521	LUCAS/TRW				
1.6 CNG 16V	69	06/06 →	FCP1640	ATE				
1.6 CNG 16V	69	06/06 →	FCP1521	LUCAS/TRW				
1.6 CNG 16V	71	04/05 →	FCP1640	ATE				
1.6 CNG 16V	71	04/05 →	FCP1521	LUCAS/TRW				
1.7 CDTI 16V	74	12/04 →	FCP1640	ATE				
1.7 CDTI 16V	74	12/04 →	FCP1521	LUCAS/TRW				
1.7 DI 16V	48	10/01 →	FCP1424	LUCAS/TRW				
1.7 DI 16V	48	10/01 →	FCP1521	LUCAS/TRW				
1.7 DTI 16V	55	10/01 →	FCP1424	LUCAS/TRW				
1.7 DTI 16V	55	10/01 →	FCP1521	LUCAS/TRW				
1.8 i 16V	92	09/00 →	FCP1424	LUCAS/TRW				

COMBO Tour

1.3 CDTI 16V	51	10/04 →	FCP1640	ATE				
1.3 CDTI 16V	51	10/04 →	FCP1521	LUCAS/TRW				
1.3 CDTI 16V	55	10/05 →	FCP1640	ATE				
1.3 CDTI 16V	55	10/05 →	FCP1521	LUCAS/TRW				
1.4	66	10/04 →	FCP1640	ATE				
1.4	66	10/04 →	FCP1521	LUCAS/TRW				
1.6	64	10/01 →	FCP1640	ATE				
1.6	64	10/01 →	FCP1521	LUCAS/TRW				
1.6 CNG	69	06/06 →	FCP1640	ATE				
1.6 CNG	69	06/06 →	FCP1521	LUCAS/TRW				
1.6 CNG	71	04/05 →	FCP1640	ATE				
1.6 CNG	71	04/05 →	FCP1521	LUCAS/TRW				
1.7 CDTI 16V	74	12/04 →	FCP1640	ATE				
1.7 CDTI 16V	74	12/04 →	FCP1521	LUCAS/TRW				
1.7 DI 16V	48	10/01 →	FCP1640	ATE				
1.7 DI 16V	48	10/01 →	FCP1521	LUCAS/TRW				
1.7 DTI 16V	55	10/01 →	FCP1640	ATE				
1.7 DTI 16V	55	10/01 →	FCP1521	LUCAS/TRW				

Commodore (A)

2.5		01/67 → 12/71	FCP11	ATE				
-----	--	---------------	-------	-----	--	--	--	--

Commodore (B)

2.5 Berlina	85, 96	01/72 → 08/77	FCP11	ATE				
2.5 Berlina	85, 96	01/72 → 08/77	FCP2	ATE				
2.5 Berlina	85, 96	08/74 → 08/77	FCP11	ATE				
2.5 Berlina	85, 96	08/74 → 08/77	FCP2	ATE				
2.5 GS	85	01/72 → 08/77	FCP11	ATE				
2.8	103	01/72 → 08/77	FCP11	ATE				
2.8	103	01/72 → 08/77	FCP2	ATE				
2.8	103	08/74 → 08/77	FCP11	ATE				
2.8	103	08/74 → 08/77	FCP2	ATE				
2.8	103, 118	01/72 → 08/77	FCP11	ATE				
2.8	103, 118	01/72 → 08/77	FCP2	ATE				
2.8	103, 118	08/74 → 08/77	FCP11	ATE				
2.8	103, 118	08/74 → 08/77	FCP2	ATE				

Commodore (C)

2.5	85, 96	08/77 → 07/82	FCP11	ATE				
2.5	85, 96	12/80 → 07/82	FCP11	ATE				

CORSA A

1.0	33	02/83 → 08/91	FCP173	GM	Vented			
1.0 S		08/91 → 02/93	FCP732	ATE				
1.2	33	07/84 → 08/91	FCP173	GM				
1.2	33	08/91 → 02/93	FCP732	ATE				
1.2	40	02/83 → 06/84	FCP173	GM				
1.3	44, 51	07/84 → 08/91	FCP173	GM				
1.3	51	02/83 → 06/84	FCP173	GM				
1.3	55	09/91 → 03/93	FCP732	ATE				
1.4	44	07/84 → 08/91	FCP173	GM				
1.4	55	07/84 → 08/91	FCP173	GM				
1.4	60	07/84 → 08/91	FCP173	GM				
1.4 N	44, 55	08/91 → 02/93	FCP732	ATE				
1.4 SE	60	08/91 → 02/93	FCP732	ATE				
1.5 D	37	07/84 → 08/91	FCP173	GM				
1.5 D	37	08/91 → 02/93	FCP732	ATE				
1.5 TD	53	08/91 → 02/93	FCP732	ATE				
1.6	55	07/84 → 08/91	FCP173	GM	Vented			
1.6	55	08/91 → 02/93	FCP732	ATE				

For material availability see page 16-18 / Per la disponibilità materiali vedere a pagina 16-18

1150

FERODO

RACING

Updated on 17th Aug 2018

OPEL



KW



...OPEL

...CORSA A

1.6	60, 74	07/84 → 08/91	FCP173	GM
1.6	60, 74	08/91 → 02/93	FCP732	ATE

CORSA B

1.0	40	03/93 → 08/00	FCP732	ATE
1.2	33	03/93 → 08/00	FCP732	ATE
1.4 N		03/93 → 08/00	FCP732	ATE
1.5 D	37	03/93 → 08/00	FCP732	ATE
1.5 TD	49	03/93 → 08/00	FCP732	ATE
1.6	78, 80	03/93 → 08/00	FCP732	ATE
1.6 GSi 16V	78	03/93 → 08/00	FCP732	ATE
1.7 D	44	03/93 → 08/00	FCP732	ATE

CORSA B (S93)

1.4 i	40	03/93 → 09/00	FCP732	ATE
1.4 i	44	03/93 → 09/00	FCP732	ATE
1.4 i 16V	66	09/94 → 09/00	FCP732	ATE
1.4 Si	60	03/93 → 09/00	FCP732	ATE

CORSA C (F08, F68)

1.0	43	09/00 →	FCP1424	LUCAS/TRW
1.2	55	09/00 →	FCP1424	LUCAS/TRW
1.4	66	09/00 →	FCP1424	LUCAS/TRW
1.4 Twinport	66	06/03 → 12/09	FCP1424	LUCAS/TRW
1.4 Twinport	66	06/03 → 12/09		FCP1521 LUCAS/TRW
1.7 CDTi	74	06/03 → 12/09	FCP1640	ATE
1.7 Di	48	09/00 →	FCP1424	LUCAS/TRW
1.7 DTi	55	09/00 →	FCP1424	LUCAS/TRW
1.8 i 16V	92	09/00 →	FCP1424	LUCAS/TRW

CORSA C Box (F08, W5L)

1.7 CDTi	74	08/03 →	FCP1640	ATE
1.7 CDTi	74	08/03 →		FCP1521 LUCAS/TRW

CORSA D

1.0	44	07/06 →	FCP1466	BOSCH
1.0	48	01/10 →	FCP1466	BOSCH
1.2	51	06/10 →	FCP1466	BOSCH
1.2	59	07/06 →	FCP1466	BOSCH
1.2	63	06/10 →	FCP1466	BOSCH
1.3 CDTi 16v	55	07/06 → 07/08	FCP1466	BOSCH
1.3 CDTi 16v	55	08/08 →	FCP1467	BOSCH
1.3 CDTi 16v	66	07/06 → 06/10	FCP1467	BOSCH
1.3 CDTi 16v	70	11/09 →	FCP1467	BOSCH
1.4	64	09/09 →	FCP1466	BOSCH
1.4	66	07/06 →	FCP1466	BOSCH
1.4	74	06/10 →	FCP1466	BOSCH
1.6 16v Turbo (OPC Nurburgring Edition)	154	06/11 →	FCP1667	BREMBO
1.6 16v Turbo (OPC Nurburgring Edition)	154	06/11 →	FCP1640	ATE
1.6 16v Turbo (OPC Nurburgring Edition)	154	06/11 →		FCP1858 BOSCH
1.6 16v Turbo (OPC)	141	02/07 →	FCP1640	ATE
1.6 16v Turbo (OPC)	141	02/07 →		FCP1858 BOSCH
1.6 16v Turbo (OPC)	141	03/07 →	FCP1667	BREMBO
1.6 Turbo	110	02/07 →	FCP1640	ATE
1.6 Turbo	110	02/07 →		FCP1858 BOSCH

Diplomat

2.8 E	118	01/68 → 12/73	FCP11	ATE
2.8 E	118	01/68 → 12/73		FCP2 ATE
2.8 i	97, 103	01/64 → 12/73	FCP11	ATE
5.4 E 16V	169	01/68 → 12/73	FCP11	ATE
5.4 E 16V	169	01/68 → 12/73		FCP2 ATE
5.4 i 16V	169	01/64 → 12/73	FCP11	ATE

Kadett (B)

1.0		01/67 → 12/73	FCP3	ATE
1.1		01/65 → 12/72	FCP3	ATE
1.2		01/67 → 12/73	FCP3	ATE
1.5	53	01/67 → 12/72	FCP2	ATE
1.9	72	01/67 → 12/72	FCP2	ATE

OPEL

For material availability see page 16-18 / Per la disponibilità materiali vedere a pagina 16-18



KW

**...OPEL****Manta (B)**

					NOTE			NOTE
1.2	44	09/75 → 08/78	FCP116	ATE				
1.2	44	09/78 → 06/88	FCP173	GM	Solid			
1.3	44, 55	09/78 → 06/88	FCP173	GM	Solid			
1.6	44, 55	09/75 → 08/78	FCP116	ATE				
1.6	44, 55	09/78 → 06/88	FCP173	GM	Solid			
1.8	66	09/78 → 06/88	FCP173	GM	Solid			
1.9	55, 66	09/78 → 06/88	FCP173	GM	Solid			
1.9	55	09/75 → 08/78	FCP116	ATE				
1.9	66	09/75 → 08/78	FCP116	ATE				
1.9	77	09/75 → 08/78	FCP116	ATE				
2.0	66	09/75 → 08/78	FCP116	ATE				
2.0	66	09/78 → 06/88	FCP173	GM	Solid			
2.0	74	09/75 → 08/78	FCP116	ATE				
2.0	74	09/78 → 06/88	FCP173	GM	Solid			
2.0	81	09/75 → 08/78	FCP116	ATE				
2.0	81	09/78 → 06/88	FCP173	GM	Solid			
2.4 16V	106	09/78 → 06/88	FCP173	GM	Solid			

MANTA B CC (53_, 55_)

2.0	92	08/81 → 07/88	FCP4489	ATE				
-----	----	---------------	---------	-----	--	--	--	--

MERIVA

1.3 CDTI	51	04/05 → 05/10	FCP1640	ATE				
1.3 CDTI	51	04/05 → 05/10				FCP1521	LUCAS/TRW	
1.3 CDTI	55	09/03 → 05/10	FCP1640	ATE				
1.3 CDTI	55	09/03 → 05/10				FCP1521	LUCAS/TRW	
1.4 16V Twinport	66	07/04 → 05/10	FCP1640	ATE	Rims 15"			
1.4 16V Twinport	66	07/04 → 05/10				FCP1521	LUCAS/TRW	
1.4 16V Twinport LPG	66	07/04 → 05/10	FCP1640	ATE	Rims 15"			
1.4 16V Twinport LPG	66	07/04 → 05/10				FCP1521	LUCAS/TRW	
1.6	64	05/03 → 05/10	FCP1424	LUCAS/TRW				
1.6	64	05/03 → 05/10				FCP1521	LUCAS/TRW	
1.6	77	01/06 → 05/10	FCP1640	ATE				
1.6	77	01/06 → 05/10				FCP1521	LUCAS/TRW	
1.6 16V	74	05/03 → 01/06	FCP1640	ATE				
1.6 16V	74	05/03 → 01/06				FCP1521	LUCAS/TRW	
1.6 Turbo	132	09/05 → 05/10	FCP1640	ATE				
1.6 Turbo	132	09/05 → 05/10				FCP1521	LUCAS/TRW	
1.7 CDTI	74	09/03 → 05/10	FCP1640	ATE				
1.7 CDTI	74	09/03 → 05/10				FCP1521	LUCAS/TRW	
1.7 CDTI	92	09/06 → 05/10	FCP1640	ATE				
1.7 CDTI	92	09/06 → 05/10				FCP1521	LUCAS/TRW	
1.7 DTI	55	09/03 → 05/10	FCP1640	ATE				
1.7 DTI	55	09/03 → 05/10				FCP1521	LUCAS/TRW	
1.8	92	05/03 → 05/10	FCP1640	ATE				
1.8	92	05/03 → 05/10				FCP1521	LUCAS/TRW	

MERIVA B

1.3 CDTI	55	06/10 →	FCP1640	ATE				
1.3 CDTI	55	06/10 →				FCP1521	LUCAS/TRW	
1.3 CDTI	70	06/10 →	FCP1640	ATE				
1.3 CDTI	70	06/10 →				FCP1521	LUCAS/TRW	
1.4	103	06/10 →	FCP1640	ATE				
1.4	103	06/10 →				FCP1521	LUCAS/TRW	
1.4	88	06/10 →	FCP1640	ATE				
1.4	88	06/10 →				FCP1521	LUCAS/TRW	
1.4	74	06/10 →	FCP1640	ATE				
1.4	74	06/10 →				FCP1521	LUCAS/TRW	
1.4 LPG	88	06/11 →	FCP1640	ATE				
1.4 LPG	88	06/11 →				FCP1521	LUCAS/TRW	
1.7 CDTI	74	06/10 →	FCP1640	ATE				
1.7 CDTI	74	06/10 →				FCP1521	LUCAS/TRW	
1.7 CDTI	81	06/10 →	FCP1640	ATE				
1.7 CDTI	81	06/10 →				FCP1521	LUCAS/TRW	
1.7 CDTI	96	06/10 →	FCP1640	ATE				
1.7 CDTI	96	06/10 →				FCP1521	LUCAS/TRW	

Monza

2.0	85	01/83 → 07/83	FCP11	ATE				
2.0	85	01/83 → 07/83				FCP2	ATE	
2.0	85	08/83 → 06/86				FCP2	ATE	
2.2	85	08/83 → 06/86				FCP2	ATE	
2.5		01/78 → 12/82	FCP11	ATE				
2.5	96	01/83 → 07/83	FCP11	ATE				
2.5	96	01/83 → 07/83				FCP2	ATE	
2.5	96	08/83 → 06/86				FCP2	ATE	
2.8		01/78 → 12/82	FCP11	ATE				

For material availability see page 16-18 / Per la disponibilità materiali vedere a pagina 16-18



KW



...OPEL

...Monza

			FCP11	ATE		FCP2	ATE		NOTE		NOTE
2.8	103	01/83 → 07/83									
2.8	103	01/83 → 07/83									
2.8	103	08/83 → 06/86									
3.0		01/78 → 12/82									
3.0	115, 132	08/83 → 06/86									
3.0	132	01/83 → 07/83									
3.0	132	01/83 → 07/83									

Olympia

1.1		01/67 → 12/72									
1.5		01/67 → 12/72									
1.9		01/67 → 12/72									

Omega (A)

1.8	65, 85	09/86 → 08/88									
1.8 Caravan	65, 85	09/89 → 03/94									
1.8 i	65, 85	09/88 → 08/89									
2.0	73, 74	09/88 → 03/94									
2.0	85, 90	09/86 → 08/88									
2.3 D	54	09/86 → 08/88									
2.3 D	74	08/88 → 03/94									
2.3 TD	66	09/86 → 08/88									
2.3 TD	74	09/88 → 03/94									
2.4	92	09/86 → 08/88									
2.4	92	09/88 → 03/94									

Omega (B)

2.0 16V	85, 100	04/94 →									
---------	---------	---------	--	--	--	--	--	--	--	--	--

Omega Lotus

3.6 V6 32V	265, 281	09/90 → 03/94									
3.6 V6 32V	265, 281	09/90 → 03/94									

Rekord (C)

1.5	40	08/69 → 01/72									
1.7 Sprint	55	01/67 → 12/71									
1.9 Sprint	55, 71	01/67 → 12/71									

Rekord (D)

1.7	44	01/74 → 04/81									
1.7 i	44	01/77 → 04/81									
1.9	55	01/74 → 04/81									
1.9 i	55	01/77 → 04/81									
2.0	43	01/74 → 04/81									
2.0	66	01/74 → 04/81									
2.0	74	09/75 → 08/77									
2.0	81	01/74 → 04/81									
2.1 D	44	01/74 → 04/81									
2.3 D	48	01/74 → 04/81									

Rekord (E)

1.7	44	04/81 → 12/86									
1.7	44	08/82 → 12/86									
1.8	66	04/81 → 07/82									
1.8	55	07/82 → 07/86									
1.8	66	07/82 → 07/86									
1.8	74	07/82 → 07/86									
1.9	55	04/81 → 12/86									
1.9	55	08/82 → 12/86									
2.0	66	09/77 → 10/82									
2.0 D	43	09/77 → 10/82									
2.0 E	81	09/77 → 10/84									
2.0 i		01/77 → 12/86									
2.1 D	44	04/81 → 07/86									
2.1 D	44	07/82 → 07/86									
2.2	85	07/82 → 07/86									
2.2 i	85	09/85 → 07/86									
2.3 D	48	04/81 → 07/82									
2.3 D	52, 63	07/82 → 07/86									

SENATOR A (29 _)

2.0 E	85	03/83 → 10/84									
2.2 E	85	11/84 → 08/87									
2.2 TD	63	11/84 → 08/87									
2.5	85	05/78 → 12/80									
2.5	85	05/78 → 12/80									

For material availability see page 16-18 / Per la disponibilità materiali vedere a pagina 16-18

1154

FERODO

RACING

Updated on 17th Aug 2018

OPEL



KW



ZAG



...OPEL

...SENATOR A (29_)

2.5 E	100	01/83	→ 08/84
2.5 E	100	01/83	→ 08/84
2.5 E	103	09/84	→ 08/87
2.8	103	02/78	→ 04/81
2.8	103	02/78	→ 04/81
3.0	110	04/78	→ 07/82
3.0	110	04/78	→ 07/82
3.0	115	09/85	→ 08/87
3.0 E	132	02/78	→ 12/86
3.0 E	132	02/78	→ 12/86

Signum (F48)

1.8	103	08/05	→ 03/07
1.8	90	02/03	→ 07/05
1.8	90	02/03	→ 07/05
1.9 CDTi	110	04/04	→
1.9 CDTi	74	08/05	→ 02/08
1.9 CDTi	88	04/04	→
2.0 DTi	74	05/03	→ 04/04
2.0 DTi	74	05/03	→ 04/04
2.0 Turbo	129	05/03	→ 12/08
2.0 Turbo	129	05/03	→ 12/08
2.2 DGi	114	02/03	→ 09/08
2.2 DGi	114	02/03	→ 09/08
2.2 DTi	92	05/03	→ 04/04
2.2 DTi	92	05/03	→ 04/04
3.0 V6 CDTi	130	05/03	→ 07/05
3.0 V6 CDTi	130	05/03	→ 07/05
3.2 V6 DGi	155	04/03	→ 07/05

Speedster

2.2 2.2i	108	10/00	→
2.2 2.2i	108	10/00	→

Tigra

1.4 16V	66	09/94	→ 12/00
1.6 16V	78	09/94	→ 12/00

Tigra Twin Top

1.3 CDTi	51	06/04	→
1.4	66	06/04	→
1.8	92	06/04	→

Vectra (A)

1.4		09/88	→ 08/91
1.4		09/91	→ 09/95
1.6	55	09/88	→ 08/91
1.6	55	09/91	→ 09/95
1.6	60	09/88	→ 08/91
1.6	60	09/91	→ 09/95
1.6	65	09/88	→ 08/91
1.6	65	09/91	→ 09/95
1.7 D	44	09/88	→ 08/91
1.7 D	44	09/91	→ 09/95
1.7 TD	60	09/91	→ 09/95
1.8	65	09/88	→ 08/91
1.8	65	09/88	→ 08/91
1.8	65	09/88	→ 08/91
1.8	65, 66	01/88	→ 09/95
1.8	66	09/91	→ 09/95
1.8 S	65, 66	01/88	→ 09/95
1.8 S	65, 66	01/88	→ 09/95
2.0	85	09/88	→ 09/95
2.0	85	09/88	→ 09/95
2.0 D 16V	74	09/88	→ 09/95
2.0 D 16V	74	09/88	→ 09/95
2.0 Turbo 4x4 16V	150	09/92	→ 09/95
2.0 Turbo 4x4 16V	150	09/92	→ 09/95
2.5	85	01/88	→ 12/95
2.5	85	01/88	→ 12/95
2.5 24V	125	09/91	→ 09/95
2.5 4 x 4 24V	125	09/91	→ 09/95
2.5 i		01/93	→ 09/95
2.5 i		01/93	→ 09/95

				NOTE				NOTE
--	--	--	--	-------------	--	--	--	-------------

FCP11	ATE				FCP2	ATE		
					FCP2	ATE		
FCP11	ATE							
FCP11	ATE				FCP2	ATE		
					FCP2	ATE		
					FCP2	ATE		
FCP11	ATE							
					FCP2	ATE		
FCP1520	ATE							
FCP1520	ATE							
					FCP1540	ATE		
FCP1520	ATE							
FCP1520	ATE							
FCP1520	ATE				FCP1540	ATE		
FCP1520	ATE							
FCP1520	ATE				FCP1540	ATE		
FCP1520	ATE							
FCP1520	ATE				FCP1540	ATE		
FCP1520	ATE							
FCP1520	ATE				FCP1540	ATE		
FCP1520	ATE							
FCP1520	ATE							
FCP1562	BREMBO							
					FCP1560	BREMBO		
FCP732	ATE							
FCP732	ATE							
FCP1424	LUCAS/TRW							
FCP1424	LUCAS/TRW							
FCP1424	LUCAS/TRW							
FCP173	GM							
FCP732	ATE							
FCP173	GM							
FCP732	ATE							
FCP173	GM							
FCP732	ATE							
FCP173	GM							
FCP732	ATE							
FCP173	GM							
FCP732	ATE							
FCP732	ATE							
FCP173	GM							
FCP584	ATE							
					FCP586	ATE		
FCP584	ATE							
FCP732	ATE							
FCP584	ATE							
					FCP586	ATE		
FCP584	ATE							
					FCP586	ATE		
FCP584	ATE							
FCP685	ATE							
					FCP586	ATE		
FCP584	ATE							
					FCP586	ATE		
FCP732	ATE							
FCP584	ATE							
FCP685	ATE							
					FCP586	ATE		

OPEL

For material availability see page 16-18 / Per la disponibilità materiali vedere a pagina 16-18



Updated on 17th Aug 2018



KW



...OPEL

Vectra (B)

2.0	100	10/95 → 04/02	FCP1068	ATE			
2.0 16V	100	10/95 → 04/02	FCP1068	ATE			
2.5 V6 24V	125	10/95 → 04/02	FCP1068	ATE			

Vectra (F35)

1.6	77	10/06 → 08/08	FCP1520	ATE			
1.6 16V	74	06/04 → 09/05	FCP1520	ATE			
1.8	103	08/05 → 08/08	FCP1520	ATE			
1.8	90	07/03 → 09/05	FCP1520	ATE			
1.9 CDTi	110	04/04 →	FCP1520	ATE			
1.9 CDTi	74	06/05 → 08/08	FCP1520	ATE			
1.9 CDTi	88	04/04 →	FCP1520	ATE			
2.0	129	10/03 → 08/08	FCP1520	ATE			
2.0 DTi	74	07/03 → 08/05	FCP1520	ATE			
2.2 DGi	114	07/03 → 08/08	FCP1520	ATE			
2.2 DTi	92	10/03 → 07/04	FCP1520	ATE			

Vectra (F68)

1.6	74	08/05 → 08/08	FCP1520	ATE			
1.6	77	01/06 → 08/08	FCP1520	ATE			
1.8	103	08/05 → 08/08	FCP1520	ATE			
1.8	81	08/02 → 12/06	FCP1520	ATE			
1.8	81	08/02 → 12/06			FCP1540	ATE	
1.8	90	04/02 → 09/05	FCP1520	ATE			
1.8	90	04/02 → 09/05			FCP1540	ATE	
1.9 CDTi	110	04/04 →	FCP1520	ATE			
1.9 CDTi	74	06/05 → 08/08	FCP1520	ATE			
1.9 CDTi	88	04/04 →	FCP1520	ATE			
2.0	129	02/03 → 08/08	FCP1520	ATE			
2.0 DTi	74	04/02 → 08/05	FCP1520	ATE			
2.0 DTi	74	04/02 → 08/05			FCP1540	ATE	
2.2	108	08/02 → 04/04	FCP1520	ATE			
2.2	108	08/02 → 04/04			FCP1540	ATE	
2.2 DGi	114	05/04 → 08/08	FCP1520	ATE			
2.2 DTi	92	08/02 → 07/04	FCP1520	ATE			
2.2 DTi	92	08/02 → 07/04			FCP1540	ATE	
3.0 CDTi	130	02/03 → 07/05	FCP1520	ATE			
3.0 CDTi	130	02/03 → 07/05			FCP1540	ATE	
3.2	155	08/02 → 07/05	FCP1520	ATE			
3.2	155	08/02 → 07/05			FCP1540	ATE	

Vectra (F69)

1.6	77	08/05 → 08/08	FCP1520	ATE			
1.6 16V	74	04/02 → 09/05	FCP1520	ATE			
1.8	103	08/05 → 08/08	FCP1520	ATE			
1.8	81	04/02 → 07/03	FCP1520	ATE			
1.8	81	04/02 → 07/03			FCP1540	ATE	
1.8	90	04/02 → 09/05	FCP1520	ATE			
1.8	90	04/02 → 09/05			FCP1540	ATE	
1.9 CDTi	110	04/04 →	FCP1520	ATE			
1.9 CDTi	74	10/05 → 08/08	FCP1520	ATE			
1.9 CDTi	88	04/04 →	FCP1520	ATE			
2.0	129	02/03 → 08/08	FCP1520	ATE			
2.0 DTi	74	04/02 → 08/05	FCP1520	ATE			
2.0 DTi	74	04/02 → 08/05			FCP1540	ATE	
2.2	108	04/02 → 04/04	FCP1520	ATE			
2.2	108	04/02 → 04/04			FCP1540	ATE	
2.2 DGi	114	05/04 → 08/08	FCP1520	ATE			
2.2 DTi	86	04/02 → 12/04	FCP1520	ATE			
2.2 DTi	86	04/02 → 12/04			FCP1540	ATE	
2.2 DTi	92	04/02 → 07/04	FCP1520	ATE			
2.2 DTi	92	04/02 → 07/04			FCP1540	ATE	
3.0 CDTi	130	02/03 → 07/05	FCP1520	ATE			
3.0 CDTi	130	02/03 → 07/05			FCP1540	ATE	
3.2	155	08/02 → 07/05	FCP1520	ATE			
3.2	155	08/02 → 07/05			FCP1540	ATE	

ZAFIRA (M75)

2.0 Turbo OPC	177	11/05 →	FCP1520	ATE			
---------------	-----	---------	---------	-----	--	--	--

ZAFIRA A (F75_)

1.6 16V	74	04/99 →	FCP1295	ATE			
1.6 16V	74	04/99 → 06/05	FCP1295	ATE			
1.6 16V	74	04/99 →			FCP1294	BOSCH	
1.6 16V	74	04/99 → 06/05			FCP1521	LUCAS/TRW	
1.6 CNG	71	09/01 → 06/05	FCP1295	ATE			

For material availability see page 16-18 / Per la disponibilità materiali vedere a pagina 16-18

1156

FERODO

RACING

Updated on 17th Aug 2018

OPEL



KW

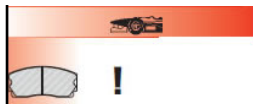

...OPEL

...ZAFIRA A (F75_)

				NOTE			NOTE
1.6 CNG	71	09/01 → 06/05					
1.8 16V	85	04/99 →	FCP1295	ATE		FCP1521	LUCAS/TRW
1.8 16V	85	04/99 → 09/00	FCP1295	ATE			
1.8 16V	85	04/99 →				FCP1294	BOSCH
1.8 16V	85	04/99 → 09/00				FCP1521	LUCAS/TRW
1.8 16V	92	09/00 → 06/05	FCP1295	ATE			
1.8 16V	92	09/00 → 06/05				FCP1521	LUCAS/TRW
2.0 DI 16V	60	10/99 → 05/01	FCP1295	ATE			
2.0 DI 16V	60	10/99 → 06/05	FCP1293	ATE	256mm disc		
2.0 DI 16V	60	10/99 → 06/05	FCP1295	ATE	280mm disc		
2.0 DI 16V	60	10/99 → 05/01				FCP1294	BOSCH
2.0 DI 16V	60	10/99 → 06/05				FCP1521	LUCAS/TRW
2.0 DTi 16V	74	07/00 →	FCP1295	ATE			
2.0 DTi 16V	74	07/00 →				FCP1294	BOSCH
2.0 DTi 16V	74	09/00 → 06/05	FCP1295	ATE			
2.0 DTi 16V	74	09/00 → 06/05				FCP1521	LUCAS/TRW
2.0 OPC	141	09/01 → 06/05	FCP1068	ATE			
2.0 OPC	141	09/01 → 06/05				FCP1521	LUCAS/TRW
2.0 OPC	147	11/02 → 06/05	FCP1068	ATE			
2.0 OPC	147	11/02 → 06/05				FCP1521	LUCAS/TRW
2.2 16V	108	09/00 → 06/05	FCP1295	ATE			
2.2 16V	108	09/00 → 06/05				FCP1521	LUCAS/TRW
2.2 DTi 16V	86	01/02 → 06/05	FCP1295	ATE			
2.2 DTi 16V	86	01/02 → 06/05				FCP1521	LUCAS/TRW
2.2 DTi 16V	92	01/02 → 06/05	FCP1295	ATE			
2.2 DTi 16V	92	01/02 → 06/05				FCP1521	LUCAS/TRW

ZAFIRA B (A05)

1.6	77	07/05 →	FCP1640	ATE			
1.6	77	07/05 →				FCP1521	LUCAS/TRW
1.6	85	01/08 →	FCP1640	ATE			
1.6	85	01/08 →				FCP1521	LUCAS/TRW
1.6 CNG	69	01/06 →	FCP1640	ATE			
1.6 CNG	69	01/06 →				FCP1521	LUCAS/TRW
1.6 CNG Turbo	110	02/09 →	FCP1640	ATE			
1.6 CNG Turbo	110	02/09 →				FCP1521	LUCAS/TRW
1.7 CDTI	81	01/08 →	FCP1640	ATE			
1.7 CDTI	81	01/08 →				FCP1521	LUCAS/TRW
1.7 CDTI	92	01/08 →	FCP1640	ATE			
1.7 CDTI	92	01/08 →				FCP1521	LUCAS/TRW
1.8	103	07/05 →	FCP1640	ATE			
1.8	103	07/05 →				FCP1521	LUCAS/TRW
1.9 CDTI	110	07/05 →	FCP1640	ATE			
1.9 CDTI	110	07/05 →				FCP1521	LUCAS/TRW
1.9 CDTI	74	07/05 →	FCP1640	ATE			
1.9 CDTI	74	07/05 →				FCP1521	LUCAS/TRW
1.9 CDTI	88	07/05 →	FCP1640	ATE			
1.9 CDTI	88	07/05 →				FCP1521	LUCAS/TRW
2.0	147	07/05 →	FCP1640	ATE			
2.0	147	07/05 →				FCP1521	LUCAS/TRW
2.0	177	01/06 →	FCP1520	ATE			
2.0	177	01/06 →				FCP1521	LUCAS/TRW
2.2	110	07/05 →	FCP1640	ATE			
2.2	110	07/05 →				FCP1521	LUCAS/TRW

ZAFIRA B Van

1.6 CNG Turbo	110	02/09 →	FCP1640	ATE			
1.6 CNG Turbo	110	02/09 →				FCP1521	LUCAS/TRW
1.7 CDTI	81	01/08 →	FCP1640	ATE			
1.7 CDTI	81	01/08 →				FCP1521	LUCAS/TRW
1.7 CDTI	92	01/08 →	FCP1640	ATE			
1.7 CDTI	92	01/08 →				FCP1521	LUCAS/TRW
1.8	103	07/05 →	FCP1295	ATE			
1.8	103	07/05 →				FCP1521	LUCAS/TRW

PEUGEOT

For material availability see page 16-18 / Per la disponibilità materiali vedere a pagina 16-18



KW

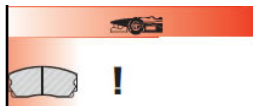

PEUGEOT

1007

1.4 HDi	50	04/05 →	FCP1399	BOSCH
1.4 i	55	04/05 →	FCP1399	BOSCH
1.6 i 16V	80	04/05 →	FCP1399	BOSCH

104

0.9 / 0.9 Coupe'	33	09/76 → 10/83	FCP253	CITROEN	09/76 ->
1.0	32	01/73 → 12/88	FCP72	BENDIX	
1.1	49	01/73 → 12/88	FCP72	BENDIX	
1.1 / 1.1 Coupe'	49	09/76 → 06/80	FCP253	CITROEN	09/76 ->
1.2	42	01/72 → 12/88	FCP72	BENDIX	
1.2	42	08/79 → 06/83	FCP253	CITROEN	
1.4	52	01/72 → 12/88	FCP72	BENDIX	

106

1.0	33, 37	09/91 → 01/96	FCP535	ATE			
1.0	33, 37	09/91 → 01/96	FCP393	BENDIX			
1.0	37	02/96 →	FCP535	ATE			
1.1	40, 44	09/91 → 12/95	FCP535	ATE			
1.1	40, 44	09/91 → 12/95	FCP393	BENDIX			
1.1	40, 44	01/96 →	FCP535	ATE			
1.3	72	01/94 → 03/96	FCP535	ATE			
1.3	72	01/94 → 03/96	FCP393	BENDIX			
1.3i Rallye	72	01/93 → 04/96	FCP876	ATE			
1.3i Rallye	72	01/93 → 04/96			FCP558	BENDIX	
1.4 D	37	09/91 → 03/96	FCP535	ATE			
1.4 D	37	09/91 → 03/96	FCP393	BENDIX			
1.4 i XSi	68	09/91 → 03/96	FCP393	BENDIX			
1.4 Not XSi	51	09/91 → 03/96	FCP535	ATE			
1.4 Not XSi	51	09/91 → 03/96	FCP393	BENDIX			
1.4 Not XSi	55	09/91 → 03/96	FCP535	ATE			
1.4 Not XSi	55	09/91 → 03/96	FCP393	BENDIX			
1.4 Not XSi	58	09/91 → 03/96	FCP535	ATE			
1.4 Not XSi	58	09/91 → 03/96	FCP393	BENDIX			
1.5 D	42	06/94 → 03/96	FCP393	BENDIX			
1.5 D	42	06/94 → 03/96	FCP535	ATE			
1.6 i	66	01/94 → 03/96	FCP393	BENDIX			
1.6 i	66	01/94 → 03/96	FCP535	ATE			
1.6 i	66	01/94 → 03/96	FCP876	ATE			
1.6 i	66	01/94 → 03/96	FCP434	LUCAS/TRW			
1.6 i 16V	87	01/94 → 03/96	FCP876	ATE			
1.6 i 16V	87	01/94 → 03/96			FCP558	BENDIX	ABS
1.6 i GTi 16V	87	01/96 →	FCP876	ATE			
1.6 i GTi 16V	87	01/96 →			FCP558	BENDIX	ABS
1.6 i Rallye	76	01/96 → 12/99	FCP876	ATE			
1.6 i Rallye	76	01/96 → 12/99			FCP558	BENDIX	ABS

107

1.0	50	06/05 →	FCP1790	BOSCH
1.4 HDi	40	06/05 →	FCP1790	BOSCH

205

1.0	32	02/83 → 07/90	FCP393	BENDIX		
1.0	32	02/83 → 07/90	FCP434	LUCAS/TRW		
1.0	33	07/87 → 07/90	FCP434	LUCAS/TRW		
1.0	33	07/87 → 07/90	FCP393	BENDIX		
1.0	37	07/87 → 07/90	FCP434	LUCAS/TRW		
1.0	37	07/87 → 07/90	FCP393	BENDIX		
1.1	36	02/83 → 07/87	FCP393	BENDIX		
1.1	36	02/83 → 07/87	FCP434	LUCAS/TRW		
1.1	40	02/83 → 07/87	FCP393	BENDIX		
1.1	40	02/83 → 07/87	FCP434	LUCAS/TRW		
1.1	44	02/83 → 07/87	FCP393	BENDIX		
1.1	44	02/83 → 07/87	FCP434	LUCAS/TRW		
1.1 i	36	01/85 → 07/87	FCP393	BENDIX		
1.1 i	40	01/85 → 07/87	FCP393	BENDIX		
1.1 i	44	01/85 → 07/87	FCP393	BENDIX		
1.3 Rallye	72, 74	01/87 → 12/93	FCP393	BENDIX		
1.4	44	02/83 → 12/94	FCP434	LUCAS/TRW		
1.4	44	02/83 → 12/94	FCP393	BENDIX		
1.4	58	02/83 → 12/94	FCP434	LUCAS/TRW		
1.4	58	02/83 → 12/94	FCP393	BENDIX		
1.4	59	02/83 → 12/94	FCP434	LUCAS/TRW		
1.4	59	02/83 → 12/94	FCP393	BENDIX		
1.6 i CTi, GTi	77, 85	03/84 → 08/92	FCP393	BENDIX		
1.6 i CTi, GTi	77, 85	03/84 → 08/92	FCP434	LUCAS/TRW		
1.6 i CTi, GTi	77, 85	03/84 → 08/92			FCP558	BENDIX
1.8 D	44	10/83 → 12/94	FCP393	BENDIX		

For material availability see page 16-18 / Per la disponibilità materiali vedere a pagina 16-18

PEUGEOT



KW

**...PEUGEOT****...205**

1.8 D	44	10/83 → 12/94	FCP434	LUCAS/TRW
1.8 D	44	01/85 → 07/87	FCP393	BENDIX
1.8 TD	58	10/83 → 12/94	FCP434	LUCAS/TRW
1.8 TD	58	09/91 → 12/94	FCP434	LUCAS/TRW
1.8 TD	58	09/91 → 12/94	FCP393	BENDIX
1.9 D	47	01/83 → 12/94	FCP393	BENDIX
1.9 D	47	01/83 → 12/94	FCP434	LUCAS/TRW
1.9 i CTi, Gentry	77	10/91 → 12/93	FCP393	BENDIX
1.9 i CTi, Gentry	77	10/91 → 12/93	FCP845	LUCAS/TRW
1.9 i CTi, Gentry	77	10/91 → 12/93		

205 I (741A/C)

1.6	55	08/86 → 10/87	FCP393	BENDIX
1.6	55	08/86 → 10/87	FCP434	LUCAS/TRW
1.9 GTI	75	03/87 → 10/87	FCP845	LUCAS/TRW
1.9 GTI	75	03/87 → 10/87		
1.9 GTI	94	10/86 → 10/87	FCP845	LUCAS/TRW
1.9 GTI	94	10/86 → 10/87		

205 I Convertible (741B, 20D)

1.6 CJ	65	08/92 → 12/94	FCP393	BENDIX
1.6 CJ	65	08/92 → 12/94	FCP434	LUCAS/TRW

205 II (20A/C)

1.6	66	08/90 → 07/92	FCP393	BENDIX
1.6	66	08/90 → 07/92	FCP434	LUCAS/TRW
1.9 GTI	75	10/87 → 05/89	FCP845	LUCAS/TRW
1.9 GTI	75	10/87 → 05/89		
1.9 GTI	88	10/87 → 10/94	FCP845	LUCAS/TRW
1.9 GTI	88	10/87 → 10/94		
1.9 GTI	94	01/87 → 12/98	FCP845	LUCAS/TRW
1.9 GTI	94	10/87 → 09/98		
1.9 GTI Cat	75	10/87 → 07/94	FCP845	LUCAS/TRW
1.9 GTI Cat	75	10/87 → 07/94		

206

1.1	44	08/98 →	FCP1378	BOSCH
1.1	44	08/98 →	FCP393	BENDIX
1.4	55	08/98 →	FCP1378	BOSCH
1.4	55	08/98 →	FCP393	BENDIX
1.4 HDi	70	09/01 →	FCP1378	BOSCH
1.4 HDi SW	50	07/02 →	FCP1378	BOSCH
1.4 i SW	55	07/02 →	FCP1378	BOSCH
1.6	66	08/98 → 11/00	FCP1378	BOSCH
1.6	66	08/98 → 11/00	FCP393	BENDIX
1.6 CC 16V	80	07/00 →	FCP1370	BOSCH
1.6 CC 16V	80	07/00 →		
1.6 CC 16V	80	09/00 →	FCP1370	BOSCH
1.6 CC 16V	80	09/00 →		
1.6 i , CC 16V	80	09/00 →	FCP1399	BOSCH
1.6 i , CC 16V	80	09/00 →		
1.6 i SW 16V	80	07/02 →	FCP1399	BOSCH
1.6 i SW 16V	80	07/02 →		
1.6 Kit car Super 1600		01/02 →	FRP1077	BREMBO
1.6 Kit car Super 1600		01/02 →		
1.6 XS Coupe	120	01/02 →	FRP219	
1.6 XS Coupe	120	01/02 →		
1.9 D	51	08/98 → 11/00	FCP1378	BOSCH
1.9 D	51	08/98 → 11/00	FCP393	BENDIX
2.0 16V, CC 16V	99	08/98 →	FCP1370	BOSCH
2.0 16V, CC 16V	99	08/98 →	FCP1378	BOSCH
2.0 16V, CC 16V	99	08/98 →		
2.0 Coupe circuit + rallye	130	01/02 →	FRP219	
2.0 Coupe circuit + rallye	130	01/02 →		
2.0 HDi	66	08/98 →	FCP1370	BOSCH
2.0 HDi	66	08/98 →		
2.0 HDi	66	12/99 →	FCP1370	BOSCH
2.0 HDi	66	12/99 →	FCP1399	BOSCH
2.0 HDi	66	12/99 →		
2.0 HDi SW	66	07/02 →	FCP1399	BOSCH
2.0 HDi SW	66	07/02 →		
2.0 i S16, CC 16V	100	04/99 →	FCP1370	BOSCH
2.0 i S16, CC 16V	100	04/99 →	FCP1399	BOSCH
2.0 i S16, CC 16V	100	04/99 →		
2.0 RC		01/99 →	FCP1467	BOSCH
2.0 XS 16V	100	01/02 →	FCP1399	BOSCH
2.0 XS 16V	100	01/02 →		

NOTE

NOTE

PEUGEOT

For material availability see page 16-18 / Per la disponibilità materiali vedere a pagina 16-18



KW



PEUGEOT

...PEUGEOT					NOTE			NOTE
...206								
2.0 XS 16V	100	07/02 →	FCP1399	BOSCH				
207								
1.6 RC	128	02/07 →	FCP1641	ATE				
1.6 RC	128	02/07 →				FCP1491	LUCAS/TRW	
1.6 Turbo	110	02/07 →	FCP1641	ATE				
1.6 Turbo	110	02/07 →				FCP1469	BOSCH	
2.0 S2000 - Asphalt		01/07 →	FRP3088	BREMBO				
2.0 S2000 - Asphalt		01/07 →				FRP3101	BREMBO	
2.0 S2000 - Gravel		01/07 →	FRP3101	BREMBO				
2.0 S2000 - Gravel		01/07 →				FRP3101	BREMBO	
Rally R3		01/09 →	FRP3107	AP RACING				
Rally R3		01/09 →				FCP1469	BOSCH	
207 (WA_, WC_)								
1.4	53	02/06 →	FCP1399	Bosch				
1.4 16V	65	02/06 →	FCP1399	Bosch				
1.4 16V	65	02/06 →				FCP1491	LUCAS/TRW	
1.4 16V	70	03/11 →	FCP1399	Bosch	for vehicles without ESP			
1.4 16V	70	03/11 →				FCP1491	LUCAS/TRW	
1.4 HDi	50	02/06 →	FCP1399	Bosch				
1.6 HDi	66	02/06 →	FCP1399	Bosch	266mm disc			
1.6 HDi	66	02/06 →				FCP1491	LUCAS/TRW	
1.6 HDi	68	11/09 →	FCP1399	Bosch	266mm disc			
1.6 HDi	68	11/09 →				FCP1491	LUCAS/TRW	
207 Saloon								
1.4	54	12/07 →	FCP1399	Bosch	266mm disc			
1.4 Bioflex	60	11/08 →	FCP1399	Bosch				
207 Sw (WK_)								
1.4	54	06/07 →	FCP1399	Bosch				
1.6 HDi	68	11/09 →	FCP1399	Bosch				
1.6 HDi	68	11/09 →				FCP1491	LUCAS/TRW	
207 Van								
1.4 HDi	50	04/07 →	FCP1399	Bosch				
1.6 HDi	66	04/07 →	FCP1399	Bosch	266mm disc			
1.6 HDi	66	04/07 →				FCP1491	LUCAS/TRW	
208								
1.0	50	03/12 →	FCP1399	Bosch	266mm disc			
1.0	50	03/12 →	FCP1641	ATE	302mm disc			
1.0	50	03/12 →				FCP1491	LUCAS/TRW	
1.2	60	03/12 →	FCP1399	Bosch	266mm disc			
1.2	60	03/12 →	FCP1641	ATE	302mm disc			
1.2	60	03/12 →				FCP1491	LUCAS/TRW	
1.4	70	03/12 →	FCP1399	Bosch	266mm disc			
1.4	70	03/12 →	FCP1641	ATE	302mm disc			
1.4	70	03/12 →				FCP1491	LUCAS/TRW	
1.4 HDi	50	03/12 →	FCP1399	Bosch	266mm disc			
1.4 HDi	50	03/12 →	FCP1641	ATE	302mm disc			
1.4 HDi	50	03/12 →				FCP1491	LUCAS/TRW	
1.6	115	03/12 →	FCP1399	Bosch	266mm disc			
1.6	115	03/12 →	FCP1641	ATE	302mm disc			
1.6	115	03/12 →				FCP1491	LUCAS/TRW	
1.6	88	03/12 →	FCP1399	Bosch	266mm disc			
1.6	88	03/12 →	FCP1641	ATE	302mm disc			
1.6	88	03/12 →				FCP1491	LUCAS/TRW	
1.6 GTi	147	08/12 →	FCP1399	Bosch	266mm disc			
1.6 GTi	147	08/12 →	FCP1641	ATE	302mm disc			
1.6 GTi	147	08/12 →				FCP1491	LUCAS/TRW	
1.6 GTi	153	10/14 →	FCP1641	ATE	302mm disc			
1.6 GTi	153	10/14 →	FCP1399	Bosch	266mm disc			
1.6 GTi	153	10/14 →	FCP1348	BREMBO	323mm disc			
1.6 GTi	153	10/14 →				FCP1491	LUCAS/TRW	
1.6 HDi	68	03/12 →	FCP1399	Bosch	266mm disc			
1.6 HDi	68	03/12 →	FCP1641	ATE	302mm disc			
1.6 HDi	68	03/12 →				FCP1491	LUCAS/TRW	
1.6 HDi	84	03/12 →	FCP1399	Bosch	266mm disc			
1.6 HDi	84	03/12 →	FCP1641	ATE	302mm disc			
1.6 HDi	84	03/12 →				FCP1491	LUCAS/TRW	
R2 Rally		01/13 →	FRP1077	ALCON				
R2 Rally		01/13 →				FCP809	LUCAS/TRW	

For material availability see page 16-18 / Per la disponibilità materiali vedere a pagina 16-18

1160



Updated on 17th Aug 2018



KW

**...PEUGEOT****304**

1.1	43	01/79 → 12/81	FCP72	BENDIX
1.3	47	08/77 → 03/81	FCP72	BENDIX
1.4 D		01/79 → 12/81	FCP72	BENDIX
1.4 D M20	33	08/77 → 10/79	FCP72	BENDIX
1.5 D	36	01/79 → 12/81	FCP72	BENDIX

305

		07/82 → 04/91	FCP434	LUCAS/TRW
All ->Ch.8987000		07/82 → 04/91	FCP393	BENDIX
All Ch.8987001->		07/82 → 04/91	FCP393	BENDIX

305 I (581A)

1.3	44	11/77 → 09/82	FCP72	BENDIX
1.5	54	11/79 → 09/82	FCP72	BENDIX
1.5	65	05/80 → 09/82	FCP72	BENDIX
1.5 Diesel	36	11/77 → 09/82	FCP72	BENDIX

306

1.1	44	02/93 → 03/97	FCP393	BENDIX
1.4	55	02/93 → 03/97	FCP393	BENDIX
1.4	55	02/93 → 08/00	FCP876	ATE ABS
1.4	55	03/97 → 08/00	FCP1378	BOSCH
1.4 i		01/93 → 04/97	FCP876	ATE
1.4 i	55	09/95 → 03/97	FCP393	BENDIX
1.4 i	55	09/95 → 03/97	FCP876	ATE
1.4 SW Estate	55	03/97 → 08/00	FCP1112	LUCAS/TRW ABS
1.6	66	02/93 → 08/95	FCP393	BENDIX
1.6	66	02/93 → 08/00	FCP876	ATE
1.6 i	66	09/95 → 02/97	FCP393	BENDIX
1.6 i	66	09/95 → 02/97	FCP876	ATE
1.6 SW Estate	66	03/97 → 08/00	FCP1112	LUCAS/TRW ABS
1.8	44, 74	02/93 → 02/97	FCP393	BENDIX
1.8	44, 74	02/93 → 08/00	FCP876	ATE
1.8 16V	82	03/97 → 08/00	FCP1112	LUCAS/TRW
1.8 D	44, 74	02/93 → 02/97	FCP393	BENDIX
1.8 D	44, 74	02/93 → 08/00	FCP876	ATE
1.8 D	44, 74	01/95 → 02/97	FCP393	BENDIX
1.8 D	44, 74	01/95 → 02/97	FCP876	ATE
1.8 i	44, 74	01/95 → 02/97	FCP393	BENDIX
1.8 i	44, 74	01/95 → 02/97	FCP876	ATE
1.9 D	50	05/99 → 08/00	FCP1112	LUCAS/TRW
1.9 D	51	05/99 → 08/00	FCP1112	LUCAS/TRW
1.9 D	66	05/99 → 08/00	FCP1112	LUCAS/TRW
1.9 D Saloon	50	03/97 → 08/00	FCP876	ATE
1.9 D Saloon	51	03/97 → 08/00	FCP876	ATE
1.9 D Saloon/SW Estate	66	03/97 → 08/00	FCP876	ATE
1.9 D SW Estate	50	03/97 → 08/00	FCP1112	LUCAS/TRW ABS
1.9 D SW Estate	51	03/97 → 08/00	FCP1112	LUCAS/TRW ABS
1.9 D SW Estate	66	03/97 → 08/00	FCP1112	LUCAS/TRW ABS
1.9 TD		05/99 → 08/00	FCP1112	LUCAS/TRW
1.9 TD	66, 69	02/93 → 02/97	FCP393	BENDIX
1.9 TD	66, 69	02/93 → 08/00	FCP876	ATE
1.9 TD	66, 69	01/95 → 02/97	FCP393	BENDIX
1.9 TD	66, 69	01/95 → 02/97	FCP876	ATE
1.9 TD SW Estate	66, 69	03/97 → 08/00	FCP1112	LUCAS/TRW
2.0 HDi Saloon/SW Estate	66	01/99 → 08/00	FCP1370	BOSCH
2.0 HDi Saloon/SW Estate	66	01/99 → 08/00	FCP1112	LUCAS/TRW
2.0 HDi Saloon/SW Estate	66	01/99 → 08/00		FCP558 BENDIX
2.0 i GTI 16V	120	03/97 → 08/00	FCP406	LUCAS/TRW
2.0 i GTI 16V	120	03/97 → 08/00	FCP565	LUCAS/TRW
2.0 i GTI 16V	120	03/97 → 08/00	FCP1112	LUCAS/TRW
2.0 i GTI 16V	120	03/97 → 08/00		FCP558 BENDIX

306 (7B, N3, N5)

2.0 S16	110	02/93 → 02/97	FCP1133	LUCAS/TRW
2.0 S16	110	02/93 → 02/97		FCP558 BENDIX
2.0 S16	110	03/97 → 05/01	FCP1112	LUCAS/TRW
2.0 S16	110	03/97 → 05/01		FCP558 BENDIX
2.0 S16	112	02/93 → 02/97	FCP1133	LUCAS/TRW
2.0 S16	112	02/93 → 02/97		FCP558 BENDIX
2.0 S16	112	03/97 → 05/01	FCP1112	LUCAS/TRW
2.0 S16	112	03/97 → 05/01		FCP558 BENDIX
2.0 ST	89	02/93 → 02/97	FCP1133	LUCAS/TRW
2.0 ST	89	02/93 → 02/97		FCP558 BENDIX
2.0 ST	89	03/97 → 05/01	FCP1112	LUCAS/TRW
2.0 ST	89	03/97 → 05/01		FCP558 BENDIX

For material availability see page 16-18 / Per la disponibilità materiali vedere a pagina 16-18



KW

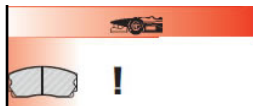

...PEUGEOT

306 Convertible (7D, N3, N5)

2.0 16V 97 03/97 → 04/02 **FCP1063** LUCAS/TRW

306 Hatchback (7A, 7C, N3, N5)

1.9 D 50 06/94 → 05/01 **FCP393** BENDIX
 1.9 D 50 06/94 → 05/01 **FCP876** ATE
 1.9 D 51 04/93 → 05/99 **FCP393** BENDIX
 1.9 D 51 04/93 → 05/99 **FCP876** ATE
 1.9 D 69 04/93 → 04/97 **FCP393** BENDIX
 1.9 D 69 04/93 → 04/97 **FCP876** ATE
 1.9 DT 66 05/93 → 05/01 **FCP393** BENDIX
 1.9 DT 66 05/93 → 05/01 **FCP876** ATE
 2.0 16V 97 03/97 → 05/01 **FCP1063** LUCAS/TRW

307

1.4 HDi 03/01 → **FCP1467** BOSCH
 1.4 HDi 03/01 → **FCP541** LUCAS/TRW
 1.4 HDi 51 03/01 → **FCP1399** BOSCH
 1.4 HDi 51 03/01 → **FCP558** BENDIX
 1.4 i 03/01 → **FCP1467** BOSCH
 1.4 i 03/01 → **FCP541** LUCAS/TRW
 1.4 i 55 03/01 → **FCP1399** BOSCH
 1.4 i 55 03/01 → **FCP558** BENDIX
 1.6 i 16V 80 03/01 → **FCP1467** BOSCH
 1.6 i 16V 80 03/01 → **FCP541** LUCAS/TRW
 1.6 i SW 16V 80 03/01 → **FCP1467** BOSCH
 1.6 i SW 16V 80 03/01 → **FCP541** LUCAS/TRW
 2.0 HDi 79 03/01 → **FCP1467** BOSCH
 2.0 HDi 79 03/01 → **FCP541** LUCAS/TRW
 2.0 HDi SW 79 03/01 → **FCP1467** BOSCH
 2.0 HDi SW 79 03/01 → **FCP541** LUCAS/TRW
 2.0 i 16V 100 03/01 → **FCP1467** BOSCH
 2.0 i 16V 100 03/01 → **FCP541** LUCAS/TRW
 2.0 i SW 16V 79 03/01 → **FCP1467** BOSCH
 2.0 i SW 16V 79 03/01 → **FCP541** LUCAS/TRW

308

1.6 GTi 270 200 06/15 → **FRP3135** ALCON

309

1.1 40, 43 09/85 → 08/92 **FCP393** BENDIX
 1.1 40, 43 09/85 → 08/92 **FCP434** LUCAS/TRW
 1.1 i 40, 44 07/89 → 08/92 **FCP393** BENDIX
 1.2 01/87 → 10/91 **FCP393** BENDIX
 1.2 01/87 → 10/91 **FCP434** LUCAS/TRW
 1.2 i 07/89 → 10/91 **FCP393** BENDIX
 1.3 47, 52 09/85 → 10/91 **FCP393** BENDIX
 1.3 47, 52 09/85 → 10/91 **FCP434** LUCAS/TRW
 1.3 i 47 06/89 → 10/91 **FCP393** BENDIX
 1.4 01/85 → 05/91 **FCP434** LUCAS/TRW
 1.4 48 06/91 → 02/93 **FCP434** LUCAS/TRW
 1.4 48 06/91 → 02/93 **FCP393** BENDIX
 1.4 50 06/91 → 02/93 **FCP434** LUCAS/TRW
 1.4 50 06/91 → 02/93 **FCP393** BENDIX
 1.4 55 06/91 → 02/93 **FCP434** LUCAS/TRW
 1.4 55 06/91 → 02/93 **FCP393** BENDIX
 1.8 01/85 → 08/89 **FCP434** LUCAS/TRW
 1.8 D 43 09/89 → 02/93 **FCP434** LUCAS/TRW
 1.8 D 43 09/89 → 02/93 **FCP393** BENDIX
 1.8 D 44 09/89 → 02/93 **FCP434** LUCAS/TRW
 1.8 D 44 09/89 → 02/93 **FCP393** BENDIX
 1.8 D 58 09/89 → 02/93 **FCP434** LUCAS/TRW
 1.8 D 58 09/89 → 02/93 **FCP393** BENDIX
 1.9 D 47 07/86 → 02/93 **FCP393** BENDIX
 1.9 D 47 07/86 → 02/93 **FCP434** LUCAS/TRW
 1.9 i GTi 89, 96 02/87 → 02/93 **FCP845** LUCAS/TRW
 1.9 i GTi 89, 96 02/87 → 02/93 **FCP558** BENDIX

309 I (10C, 10A)

1.6 53 08/87 → 07/89 **FCP393** BENDIX
 1.6 53 08/87 → 07/89 **FCP434** LUCAS/TRW
 1.6 55 10/85 → 07/89 **FCP393** BENDIX
 1.6 55 10/85 → 07/89 **FCP434** LUCAS/TRW
 1.6 76 11/85 → 09/88 **FCP393** BENDIX
 1.6 76 11/85 → 09/88 **FCP434** LUCAS/TRW
 1.6 Cat 55 09/86 → 12/89 **FCP393** BENDIX
 1.6 Cat 55 09/86 → 12/89 **FCP434** LUCAS/TRW

For material availability see page 16-18 / Per la disponibilità materiali vedere a pagina 16-18

PEUGEOT



KW



...PEUGEOT

309 II (3C, 3A)

1.6	65	07/89 → 12/93	FCP393	BENDIX
1.6	65	07/89 → 12/93	FCP434	LUCAS/TRW

405

1.4 i Saloon	50	07/92 → 10/96	FCP393	BENDIX
1.4 i Saloon	50	07/92 → 10/96	FCP393	BENDIX
1.4 i Saloon	55	07/92 → 10/96	FCP393	BENDIX
1.4 i Saloon	55	07/92 → 10/96	FCP393	BENDIX
1.4 i Saloon	58	07/92 → 10/96	FCP393	BENDIX
1.4 i Saloon	58	07/92 → 10/96	FCP393	BENDIX
1.4 i SW Estate	55	02/94 → 02/97	FCP393	BENDIX
1.4 i SW Estate	55	02/94 → 02/97	FCP393	BENDIX
1.4 i SW Estate	55, 58	07/92 → 01/94	FCP393	BENDIX
1.4 i SW Estate	55, 58	07/92 → 01/94	FCP393	BENDIX
1.4 Saloon	50	06/87 → 10/96	FCP393	BENDIX
1.4 Saloon	50	06/87 → 10/96	FCP1133	LUCAS/TRW
1.4 Saloon	55	06/87 → 10/96	FCP393	BENDIX
1.4 Saloon	55	06/87 → 10/96	FCP1133	LUCAS/TRW
1.4 Saloon	58	06/87 → 10/96	FCP393	BENDIX
1.4 Saloon	58	06/87 → 10/96	FCP1133	LUCAS/TRW
1.4 SW Estate	55, 58	06/87 → 02/97	FCP393	BENDIX
1.4 SW Estate	55, 58	06/87 → 02/97	FCP1133	LUCAS/TRW
1.6 SW Estate	65, 66	02/94 → 02/97	FCP393	BENDIX
1.6 SW Estate	65, 66	02/94 → 02/97	FCP1133	LUCAS/TRW
1.6 SW Estate	65, 66	02/94 → 02/97	FCP393	BENDIX
1.6 SW Estate	65, 66	02/94 → 02/97	FCP1133	LUCAS/TRW
1.7 TD Saloon & SW Estate		06/88 → 06/90	FCP393	BENDIX
1.7 TD Saloon & SW Estate		06/88 → 06/90	FCP393	BENDIX
1.8 i Saloon	74	01/92 → 10/96	FCP393	BENDIX
1.8 i Saloon	74	01/92 → 10/96	FCP393	BENDIX
1.8 i SW Estate	74	01/92 → 01/94	FCP393	BENDIX
1.8 i SW Estate	74	02/94 → 02/97	FCP393	BENDIX
1.8 i SW Estate	74	02/94 → 02/97	FCP393	BENDIX
1.8 i SW Estate	74	02/94 → 02/97	FCP393	BENDIX
1.8 Saloon	74	06/87 → 10/96	FCP393	BENDIX
1.8 Saloon	74	06/87 → 10/96	FCP1133	LUCAS/TRW
1.8 Saloon	74	06/87 → 10/96	FCP393	BENDIX
1.8 Saloon	74	06/87 → 10/96	FCP1133	LUCAS/TRW
1.8 SW Estate	74	06/87 → 02/97	FCP393	BENDIX
1.8 SW Estate	74	06/87 → 02/97	FCP1133	LUCAS/TRW
1.8 SW Estate	74	06/87 → 02/97	FCP393	BENDIX
1.8 SW Estate	74	06/87 → 02/97	FCP1133	LUCAS/TRW
1.8 TD Saloon	66	07/90 → 08/92	FCP393	BENDIX
1.8 TD Saloon	66	07/90 → 08/92	FCP393	BENDIX
1.8 TD Saloon	66	09/92 → 10/96	FCP393	BENDIX
1.8 TD Saloon	66	09/92 → 10/96	FCP393	BENDIX
1.8 TD SW Estate	66	07/90 → 08/92	FCP393	BENDIX
1.8 TD SW Estate	66	07/90 → 08/92	FCP393	BENDIX
1.8 TD SW Estate	66	09/92 → 01/94	FCP393	BENDIX
1.8 TD SW Estate	66	09/92 → 01/94	FCP393	BENDIX
1.8 TD Saloon	66	06/87 → 10/96	FCP393	BENDIX
1.8 TD Saloon	66	06/87 → 10/96	FCP1133	LUCAS/TRW
1.8 TD Saloon	66	06/87 → 10/96	FCP393	BENDIX
1.8 TD Saloon	66	06/87 → 10/96	FCP1133	LUCAS/TRW
1.8 TD SW Estate	66	06/87 → 01/94	FCP393	BENDIX
1.8 TD SW Estate	66	06/87 → 01/94	FCP1133	LUCAS/TRW
1.8 TD SW Estate	66	06/87 → 01/94	FCP393	BENDIX
1.8 TD SW Estate	66	06/87 → 01/94	FCP1133	LUCAS/TRW
1.9 i Saloon	70	07/92 → 10/96	FCP393	BENDIX
1.9 i Saloon	70	07/92 → 10/96	FCP393	BENDIX
1.9 i Saloon	80	07/92 → 10/96	FCP393	BENDIX
1.9 i Saloon	80	07/92 → 10/96	FCP393	BENDIX
1.9 i Saloon	88	07/92 → 10/96	FCP393	BENDIX
1.9 i Saloon	88	07/92 → 10/96	FCP393	BENDIX
1.9 MI 16 16V	108, 118	01/87 → 12/92	FCP1133	LUCAS/TRW
1.9 MI 16 16V	108, 118	01/87 → 12/92	FCP1133	LUCAS/TRW
1.9 Saloon	70	06/87 → 10/96	FCP1133	LUCAS/TRW
1.9 Saloon	70	06/87 → 10/96	FCP393	BENDIX
1.9 Saloon	70	06/87 → 10/96	FCP393	BENDIX
1.9 Saloon	80	06/87 → 10/96	FCP1133	LUCAS/TRW
1.9 Saloon	80	06/87 → 10/96	FCP393	BENDIX
1.9 Saloon	80	06/87 → 10/96	FCP393	BENDIX
1.9 Saloon	80	06/87 → 10/96	FCP1133	LUCAS/TRW
1.9 Saloon	88	06/87 → 10/96	FCP1133	LUCAS/TRW
1.9 Saloon	88	06/87 → 10/96	FCP393	BENDIX
1.9 Saloon	88	06/87 → 10/96	FCP393	BENDIX
1.9 Saloon	88	06/87 → 10/96	FCP1133	LUCAS/TRW
1.9 SW Estate	50	02/94 → 02/97	FCP393	BENDIX
1.9 SW Estate	50	02/94 → 02/97	FCP1133	LUCAS/TRW
1.9 SW Estate	50	02/94 → 02/97	FCP393	BENDIX
1.9 SW Estate	50	02/94 → 02/97	FCP1133	LUCAS/TRW
1.9 SW Estate	77, 80	06/87 → 01/94	FCP393	BENDIX
1.9 SW Estate	77, 80	06/87 → 01/94	FCP1133	LUCAS/TRW
1.9 SW Estate	77, 80	06/87 → 01/94	FCP393	BENDIX
1.9 SW Estate	77, 80	06/87 → 01/94	FCP1133	LUCAS/TRW
1.9 TD	92	08/92 → 12/96	FCP1133	LUCAS/TRW
1.9 TD	92	08/92 → 12/96	FCP1133	LUCAS/TRW

NOTE

NOTE

PEUGEOT

For material availability see page 16-18 / Per la disponibilità materiali vedere a pagina 16-18



KW

**...PEUGEOT****...405**

2.0 i MI 16 16V	110	08/92 → 12/96
2.0 i MI 16 16V	110	08/92 → 12/96
2.0 Saloon, SW Estate	89	08/92 → 02/97
2.0 Saloon, SW Estate	89	08/92 → 02/97

FCP1133	LUCAS/TRW
FCP1133	LUCAS/TRW

NOTE

NOTE

FCP541	LUCAS/TRW
FCP541	LUCAS/TRW

405 I (15B)

1.6	53	07/87 → 12/92
1.6	53	07/87 → 12/92
1.6	55	07/87 → 06/88
1.6	55	07/87 → 06/88
1.6	65	07/87 → 12/92
1.6	65	07/87 → 12/92
1.6	66	10/89 → 12/92
1.6	66	10/89 → 12/92
1.6	69	01/87 → 12/92
1.6	69	01/87 → 12/92
1.6 4x4	65	04/88 → 07/92
1.6 4x4	65	04/88 → 07/92

FCP393	BENDIX
FCP393	BENDIX
FCP393	BENDIX
FCP393	BENDIX
FCP393	BENDIX
FCP393	BENDIX
FCP393	BENDIX
FCP393	BENDIX
FCP393	BENDIX
FCP393	BENDIX
FCP393	BENDIX

FCP541	LUCAS/TRW
FCP541	LUCAS/TRW
FCP541	LUCAS/TRW
FCP541	LUCAS/TRW
FCP541	LUCAS/TRW
FCP541	LUCAS/TRW
FCP541	LUCAS/TRW
FCP541	LUCAS/TRW
FCP541	LUCAS/TRW
FCP541	LUCAS/TRW
FCP541	LUCAS/TRW

405 I Break (15E)

1.6	65	10/88 → 08/92
1.6	65	10/88 → 08/92
1.6	65	10/88 → 08/92
1.6	66	10/88 → 08/92
1.6	66	10/88 → 08/92
1.6	66	10/88 → 08/92
1.6	68	05/88 → 07/92
1.6	68	05/88 → 07/92
1.6	68	05/88 → 07/92
1.6 SRi 4x4	65	04/88 → 07/92
1.6 SRi 4x4	65	04/88 → 07/92
1.6 SRi 4x4	65	04/88 → 07/92

FCP393	BENDIX
FCP1133	LUCAS/TRW
FCP393	BENDIX
FCP1133	LUCAS/TRW
FCP393	BENDIX
FCP1133	LUCAS/TRW
FCP393	BENDIX
FCP1133	LUCAS/TRW
FCP393	BENDIX
FCP1133	LUCAS/TRW
FCP1133	LUCAS/TRW

FCP541	LUCAS/TRW
FCP541	LUCAS/TRW
FCP541	LUCAS/TRW
FCP541	LUCAS/TRW
FCP541	LUCAS/TRW
FCP541	LUCAS/TRW
FCP541	LUCAS/TRW
FCP541	LUCAS/TRW
FCP541	LUCAS/TRW
FCP541	LUCAS/TRW
FCP541	LUCAS/TRW

405 II (4B)

1.6	65	08/92 → 10/95
1.6	65	08/92 → 10/95
1.6	65	08/92 → 10/95
1.6	66	08/92 → 05/97

FCP393	BENDIX
FCP1133	LUCAS/TRW
FCP393	BENDIX
FCP393	BENDIX

FCP541	LUCAS/TRW
--------	-----------

405 II Break (4E)

1.6	65	08/92 → 10/96
1.6	65	08/92 → 10/96
1.6	68	08/92 → 08/94
1.6	68	08/92 → 08/94

FCP393	LUCAS/TRW
FCP393	LUCAS/TRW
FCP393	LUCAS/TRW
FCP393	LUCAS/TRW

FCP541	LUCAS/TRW
FCP541	LUCAS/TRW

406

2.0 Coupe 16V	99	05/97 →
2.0 HDi	66, 81	04/99 →
2.0 Saloon, SW Estate	99	10/95 →
2.1 TD Saloon, SW Estate	80	10/95 → 10/97
3.0 Coupe V6 24V	140	02/97 →

FCP1063	LUCAS/TRW
FCP1063	LUCAS/TRW
FCP1063	LUCAS/TRW
FCP1063	LUCAS/TRW
FCP1348	BREMBO

406 (8B)

1.9 TD	66	01/96 → 05/04
1.9 TD	68	01/96 → 05/04
1.9 TD	69	10/95 → 10/97
2.0 16V	100	08/00 → 06/04
2.0 16V	99	01/99 → 08/00
2.0 16V	97	11/95 → 05/04
2.0 16V HPI	103	05/01 → 05/04
2.0 HDi 110	79	08/01 → 05/04
2.0 HDi 110	80	06/98 → 08/01
2.0 HDi 90	66	02/99 → 05/04
2.0 Turbo	108	04/96 → 05/04
2.1 TD 12V	80	01/96 → 05/04
2.2	116	07/00 → 05/04
2.2 HDi	98	03/00 → 05/04
3.0 24V	140	10/96 → 05/04
3.0 V6	152	03/00 → 05/04

FCP1063	LUCAS/TRW
FCP1063	LUCAS/TRW
FCP1063	LUCAS/TRW
FCP1063	LUCAS/TRW
FCP1063	LUCAS/TRW
FCP1063	LUCAS/TRW
FCP1063	LUCAS/TRW
FCP1063	LUCAS/TRW
FCP1063	LUCAS/TRW
FCP1063	LUCAS/TRW
FCP1063	LUCAS/TRW
FCP1063	LUCAS/TRW
FCP1063	LUCAS/TRW
FCP1063	LUCAS/TRW
FCP1063	LUCAS/TRW

406 Break (8E/F)

1.8 16V	85	10/00 → 10/04
1.8 16V	81	10/96 → 10/00
1.9 D	55	10/96 → 10/04
1.9 TD	66	10/96 → 10/04
2.0 16V	100	10/00 → 10/04

FCP1063	LUCAS/TRW
FCP1063	LUCAS/TRW
FCP1063	LUCAS/TRW
FCP1063	LUCAS/TRW
FCP1063	LUCAS/TRW

For material availability see page 16-18 / Per la disponibilità materiali vedere a pagina 16-18



KW

**...PEUGEOT****...406 Break (8E/F)**

2.0 16V	99	01/99 → 10/00	FCP1063	LUCAS/TRW
2.0 16V	97	10/96 → 10/04	FCP1063	LUCAS/TRW
2.0 16V HPi	103	05/01 → 10/04	FCP1063	LUCAS/TRW
2.0 HDi 110	79	08/01 → 10/04	FCP1063	LUCAS/TRW
2.0 HDi 110	80	02/99 → 04/04	FCP1063	LUCAS/TRW
2.0 HDi 90	66	02/99 → 10/04	FCP1063	LUCAS/TRW
2.0 Turbo	108	10/96 → 10/04	FCP1063	LUCAS/TRW
2.1 TD 12V	80	10/96 → 10/04	FCP1063	LUCAS/TRW
2.2	116	07/00 → 10/04	FCP1063	LUCAS/TRW
2.2 HDi	98	03/00 → 10/04	FCP1063	LUCAS/TRW
3.0 24V	140	10/96 → 10/04	FCP1063	LUCAS/TRW
3.0 V6	152	03/00 → 10/04	FCP1063	LUCAS/TRW

406 Coupe (8C)

2.0 16V	100	10/00 → 12/04	FCP1063	LUCAS/TRW
2.0 16V	99	01/99 → 10/00	FCP1063	LUCAS/TRW
2.0 16V	97	03/97 → 12/04	FCP1063	LUCAS/TRW
2.0 16V	99	04/99 → 09/04	FCP1063	LUCAS/TRW
2.2	116	03/02 → 12/04	FCP1063	LUCAS/TRW
2.2 HDi	98	03/00 → 12/04	FCP1063	LUCAS/TRW

407

1.6 1.6 HdI 110 FAP, SW Estate 16V	80	05/04 →	FCP1725	LUCAS/TRW
1.6 1.6 HdI 110 FAP	80	05/04 →	FCP1725	LUCAS/TRW
1.8 1.08	85	05/04 →	FCP1725	LUCAS/TRW
1.8 1.8 16V	125	09/05 →	FCP1725	LUCAS/TRW
1.8 1.8i ,SW Estate 16V	85	05/04 →	FCP1725	LUCAS/TRW
2.2 0 HDi 135 FAP	100	05/04 →	FCP1725	LUCAS/TRW
2.0 2.0 16V	140	09/05 →	FCP1725	LUCAS/TRW
2.0 2.0 HdI 135 FAP, SW Estate 16V	100	05/04 →	FCP1725	LUCAS/TRW
2.0 2.0 0	100	05/04 →	FCP1725	LUCAS/TRW
2.0 2.0i 16V	100	05/04 →	FCP1725	LUCAS/TRW

407 Estate

1.8 1.8 16V	125	09/05 →	FCP1725	LUCAS/TRW
2.0 2.0 16V	140	09/05 →	FCP1725	LUCAS/TRW

607

2.2 16V		01/99 →	FCP1063	LUCAS/TRW
2.2 HDi 16V	100	01/99 →	FCP1063	LUCAS/TRW

607 (9D, 9U)

2.0	100	02/00 →	FCP1063	LUCAS/TRW
2.0 HDi	79	03/01 → 07/04	FCP1063	LUCAS/TRW
2.0 HDi	80	05/00 →	FCP1063	LUCAS/TRW
2.2 16V	116	02/00 →	FCP1063	LUCAS/TRW
2.2 HDi	98	02/00 →	FCP1063	LUCAS/TRW

806

1.9 TD	68	01/94 → 07/02	FCP565	LUCAS/TRW
1.9 TD	68	01/94 → 07/02		FCP850 ATE
2.0	89	01/94 → 07/02	FCP565	LUCAS/TRW
2.0	89	01/94 → 07/02		FCP850 ATE
2.0 (Turbo)	104	10/95 → 07/02	FCP565	LUCAS/TRW
2.0 (Turbo)	104	10/95 → 07/02		FCP850 ATE
2.0 HDi	80	05/99 → 07/02	FCP565	LUCAS/TRW
2.0 HDi	80	05/99 → 07/02		FCP850 ATE
2.1 TD	80	04/96 → 07/02	FCP565	LUCAS/TRW
2.1 TD	80	04/96 → 07/02		FCP850 ATE

Enterprise

All Models		01/94 →	FCP876	ATE
------------	--	---------	--------	-----

Expert

1.9 D 900 Kg	51	10/95 →	FCP565	LUCAS/TRW
1.9 TD 900 Kg	66, 69	10/95 →	FCP565	LUCAS/TRW

Partner

1.1	44	07/96 → 09/01	FCP1112	LUCAS/TRW
1.4	55	07/96 → 09/01	FCP1112	LUCAS/TRW
1.6 i 16V	80	10/00 → 09/01	FCP1112	LUCAS/TRW
1.7 D		09/96 → 09/01	FCP1112	LUCAS/TRW
1.8 D	44	07/96 → 09/01	FCP1112	LUCAS/TRW
1.9 D	51	07/96 → 09/01	FCP1112	LUCAS/TRW
2.0 HDi	66	01/00 → 09/01	FCP1112	LUCAS/TRW

For material availability see page 16-18 / Per la disponibilità materiali vedere a pagina 16-18



KW



...PEUGEOT

Partner/Ranch

1.1 i	44	07/96 → 09/01	FCP1112	LUCAS/TRW
1.1 i	44	10/01 →	FCP1399	BOSCH
1.4 i	55	07/96 → 09/01	FCP1112	LUCAS/TRW
1.4 i	55	10/01 →	FCP1399	BOSCH
1.6 i 16V	80	10/01 →	FCP1399	BOSCH
1.8 i	66	05/97 → 09/01	FCP1112	LUCAS/TRW
1.9 D	51	07/96 → 09/01	FCP1112	LUCAS/TRW
1.9 D	51	10/01 →	FCP1399	BOSCH
2.0 HDi	66	12/99 → 09/01	FCP1112	LUCAS/TRW
2.0 HDi	66	10/01 →	FCP1399	BOSCH

RCZ

1.6 THP 270	199	06/13 →	FRP3135	ALCON	Versione R - KtypeNr=52427
-------------	-----	---------	---------	-------	----------------------------

PIPER

GTT

1.7		01/68 → 12/74	FCP809	LUCAS/TRW		
1.7		01/68 → 12/74			FCP809	LUCAS/TRW

POLSKI

125

1.3	50	01/75 →	FCP29	BENDIX
PX Linda 160		01/84 →	FCP29	BENDIX
PX1300, 1500		01/75 → 12/84	FCP29	BENDIX

Baltic

		06/78 →	FCP29	BENDIX
--	--	---------	-------	--------

Polonez

1.5		06/78 → 06/90	FCP29	BENDIX
-----	--	---------------	-------	--------

PONTIAC

2+2

		01/69 → 12/81	FRP3057	KELGATE
		01/82 → 12/86	FRP3058	KELGATE

Bonneville

4.9 16V	112	01/75 → 12/77	FRP3057	KELGATE
5.7 16V	125	01/75 → 12/77	FRP3057	KELGATE
6.6 16V	105	01/75 → 12/77	FRP3057	KELGATE

Cataline

		01/69 → 12/81	FRP3057	KELGATE
		01/82 → 12/86	FRP3058	KELGATE

Firebird

		01/82 → 12/88	FRP3058	KELGATE		
		01/82 → 12/88			FRP3058	KELGATE
		01/89 → 12/92	FCP1224	KELGATE		
3.8	86	01/72 → 12/81	FRP3057	KELGATE		
4.1	83	01/72 → 12/81	FRP3057	KELGATE		
4.9 16V	112	01/72 → 12/81	FRP3057	KELGATE		
5.0 16V	119	01/72 → 12/81	FRP3057	KELGATE		
5.7 16V	132	01/72 → 12/81	FRP3057	KELGATE		
6.6 16V	138	01/72 → 12/81	FRP3057	KELGATE		
7.5 16V	140	01/72 → 12/81	FRP3057	KELGATE		

Firebird, Trans Am

		01/69 → 12/78	FRP3057	KELGATE		
		01/79 → 12/81	FRP3057	KELGATE		
		01/79 → 12/81			FRP3058	KELGATE

For material availability see page 16-18 / Per la disponibilità materiali vedere a pagina 16-18



KW



...PONTIAC						NOTE			NOTE
Grand Am									
		01/69 → 12/77	FRP3057	KELGATE					
		01/78 → 12/81	FRP3058	KELGATE					
Grand Prix									
		01/69 → 12/77	FRP3057	KELGATE					
		01/78 → 12/87	FRP3058	KELGATE					
Grandville									
		01/69 → 12/81	FRP3057	KELGATE					
		01/82 → 12/86	FRP3058	KELGATE					
GTO									
		01/69 → 12/77	FRP3057	KELGATE					
		01/78 → 12/81	FRP3058	KELGATE					
Judge									
		01/69 → 12/77	FRP3057	KELGATE					
		01/78 → 12/81	FRP3058	KELGATE					
Le Mans									
4.1	83	01/75 → 12/77	FRP3057	KELGATE					
5.7 16V	114	01/75 → 12/77	FRP3057	KELGATE					
6.6 16V	105	01/75 → 12/77	FRP3057	KELGATE					
6.6 16V	105	01/78 → 12/81	FRP3058	KELGATE					
Parisiene									
		01/84 → 12/89	FRP3057	KELGATE					
Phoenix									
		01/69 → 12/79	FRP3057	KELGATE					
Safari Wagon									
2.8		01/84 → 12/89	FRP3057	KELGATE					
Solstice									
2.4 VVTi	132	03/05 →				FCP1931	ATE		
Tempest									
		01/69 → 12/77	FRP3057	KELGATE					
		01/78 → 12/81	FRP3058	KELGATE					
Ventura									
		01/69 → 12/79	FRP3057	KELGATE					
PORSCHE									
1600									
1.6		01/64 → 12/65	FCP2	ATE					
1.6		01/64 → 12/65				FCP3	ATE		
356									
1.6 C, SC		01/63 → 12/66	FCP2	ATE					
1.6 C, SC		01/63 → 12/66				FCP3	ATE		
718 Boxster (982)									
2.0	220	04/16 →	FCP4805	BREMBO	For vehicles without ceramic discs				
S 2.5	257	04/16 →				FCP1308	BREMBO		
718 CAYMAN (982)									
2.5 GTS	269	10/17 →	FCP4805	BREMBO	For vehicles without ceramic discs				
2.5 GTS	269	10/17 →				FCP1308	BREMBO		
S 2.5	257	04/16 →				FCP1308	BREMBO		
904									
2.0 Carrera GTS		01/63 → 12/65	FCP2	ATE					
2.0 Carrera GTS		01/63 → 12/65				FCP3	ATE		

PORSCHE

For material availability see page 16-18 / Per la disponibilità materiali vedere a pagina 16-18



KW



...PORSCHE

908/1

3.0		01/68 → 12/71	FCP11	ATE			
3.0		01/68 → 12/71			FCP11	ATE	

911

2.0		01/65 → 12/69	FCP2	ATE			
2.0		01/65 → 12/69			FCP3	ATE	
2.2		01/70 → 12/71	FCP11	ATE			
2.2		01/70 → 12/71			FCP2	ATE	
2.3		01/72 → 12/73	FCP11	ATE			
2.3		01/72 → 12/73			FCP2	ATE	
3.3 (Turbo)	235	01/90 → 06/91	FCP560	ATE			
3.3 (Turbo)	235	01/90 → 06/91			FCP451	ATE	
3.3 (Turbo)	235	07/91 → 09/93	FCP891	ATE			
3.3 (Turbo)	235	07/91 → 09/93			FCP451	ATE	
3.3 ,Sport (Turbo)	243	09/77 → 06/89	FCP451	ATE			
3.3 ,Sport (Turbo)	243	09/77 → 06/89			FCP451	ATE	
3.6 (Turbo)	300	03/95 → 04/98	FCP891	ATE			
3.6 (Turbo)	300	03/95 → 04/98			FCP560	ATE	
3.6 ,New Carrera (Turbo)	184	12/93 → 12/97	FCP560	ATE			
3.6 ,New Carrera (Turbo)	184	12/93 → 12/97			FCP451	ATE	
3.6 Carrera 2, 4	184	09/89 → 09/93	FCP451	ATE			
3.6 Carrera 2, 4	184	09/89 → 09/93			FCP451	ATE	
3.6 Carrera RS	191	09/91 → 06/93	FCP560	ATE			
3.6 Carrera RS	191	09/91 → 06/93			FCP451	ATE	
3.8 Carrera	210, 221	06/95 →	FCP560	ATE			
3.8 Carrera	210, 221	06/95 →			FCP451	ATE	

911 (991)

3.0 Carrera 4 GTS	331	03/17 →			FCP4713	BREMBO	For vehicles without ceramic discs
3.0 Carrera 4S	309	11/15 →	FCP4955	BREMBO			For vehicles without ceramic discs
3.0 Carrera 4S	309	11/15 →			FCP4713	BREMBO	
3.0 Carrera GTS	331	03/17 →			FCP4713	BREMBO	For vehicles without ceramic discs
3.0 Carrera S	309	11/15 →	FCP4955	BREMBO			For vehicles without ceramic discs
3.0 Carrera S	309	11/15 →			FCP4713	BREMBO	
3.4 Carrera	257	12/11 →	FCP4955	BREMBO			
3.4 Carrera	257	12/11 →			FCP4713	BREMBO	
3.4 Carrera	261	12/11 →	FCP4955	BREMBO			
3.4 Carrera	261	12/11 →			FCP4713	BREMBO	
3.4 Carrera 4	257	11/12 →	FCP4955	BREMBO			
3.4 Carrera 4	257	11/12 →			FCP4713	BREMBO	
3.4 Carrera 4	261	09/12 →	FCP4955	BREMBO			
3.4 Carrera 4	261	09/12 →			FCP4713	BREMBO	
3.8 Carrera 4S	294	11/12 →	FCP4955	BREMBO			
3.8 Carrera 4S	304	12/11 →	FCP4955	BREMBO			
3.8 Carrera 4S / 4 GTS	316	11/12 →	FCP4955	BREMBO			
3.8 Carrera S	294	12/11 →	FCP4955	BREMBO			
3.8 Carrera S	304	12/11 →	FCP4955	BREMBO			
3.8 Carrera S / GTS	316	07/12 →	FCP4955	BREMBO			
3.8 GT3	350	08/13 →	FCP4664	BREMBO			
3.8 GT3	350	08/13 →			FCP4665	BREMBO	
3.8 Turbo	383	09/13 →	FCP4664	BREMBO			
3.8 Turbo	383	09/13 →			FCP4665	BREMBO	
3.8 Turbo S	412	09/13 →	FCP4664	BREMBO			
3.8 Turbo S	412	09/13 →			FCP4665	BREMBO	

911 (996)

3.4 Carrera	221	09/97 → 09/01	FRP3051	BREMBO			
3.4 Carrera	221	09/97 → 09/01			FCP1308	BREMBO	
3.4 Carrera	235	05/01 → 08/05	FRP3051	BREMBO			
3.4 Carrera	235	05/01 → 08/05			FCP1308	BREMBO	
3.4 Carrera 4	221	09/97 → 09/01	FRP3051	BREMBO			
3.4 Carrera 4	221	09/97 → 09/01			FCP1308	BREMBO	
3.4 Carrera 4	235	05/01 → 08/05	FRP3051	BREMBO			
3.4 Carrera 4	235	05/01 → 08/05			FCP1308	BREMBO	
3.6 Carrera	235	10/01 → 08/05	FRP3051	BREMBO			
3.6 Carrera	235	10/01 → 08/05			FCP1308	BREMBO	
3.6 Carrera 4	235	10/01 → 08/05	FRP3051	BREMBO			
3.6 Carrera 4	235	10/01 → 08/05			FCP1308	BREMBO	
3.6 Carrera 4S	254	02/03 → 08/05	FRP3050	BREMBO			
3.6 Carrera 4S	254	02/03 → 08/05			FRP3051	BREMBO	
3.6 Carrera S	254	02/03 → 08/05	FRP3051	BREMBO			
3.6 Carrera S	254	02/03 → 08/05			FCP1308	BREMBO	
3.6 GT2	340	04/01 → 08/05	FRP3050	BREMBO			Model year to 12.02
3.6 GT2	340	04/01 → 08/05	FRP3075	BREMBO			Model year from 01.04
3.6 GT2	340	04/01 → 08/05			FRP3051	BREMBO	
3.6 GT2	355	10/03 → 08/05	FRP3075	BREMBO			For vehicles without ceramic discs
3.6 GT2	355	10/03 → 08/05			FRP3051	BREMBO	

For material availability see page 16-18 / Per la disponibilità materiali vedere a pagina 16-18



KW

**...PORSCHE****...911 (996)**

					NOTE			NOTE
3.6 GT3	265	03/99 → 08/05	FRP3050	BREMBO	Model year to 12.02			
3.6 GT3	265	03/99 → 08/05	FRP3075	BREMBO	Model year from 01.04			
3.6 GT3	265	03/99 → 08/05				FRP3051	BREMBO	
3.6 GT3	280	03/03 → 08/05	FRP3075	BREMBO	For vehicles without ceramic discs			
3.6 GT3	280	03/03 → 08/05				FRP3051	BREMBO	
3.6 S	331	08/04 → 08/05	FRP3050	BREMBO				
3.6 S	331	08/04 → 08/05				FRP3051	BREMBO	
3.6 Turbo 4	309	06/00 → 08/05	FRP3050	BREMBO	Model year to 12.02			
3.6 Turbo 4	309	06/00 → 08/05	FRP3075	BREMBO	Model year from 01.04			
3.6 Turbo 4	309	06/00 → 08/05				FRP3051	BREMBO	
3.6 Turbo 4S	331	02/03 → 08/05	FRP3075	BREMBO	For vehicles without ceramic discs			
3.6 Turbo 4S	331	02/03 → 08/05				FRP3051	BREMBO	

911 (997)

3.6 Carrera	235	08/04 → 07/05	FRP3051	BREMBO				
3.6 Carrera	235	08/04 → 07/05				FCP1308	BREMBO	
3.6 Carrera	239	07/04 → 12/08	FRP3051	BREMBO				
3.6 Carrera	239	07/04 → 12/08				FCP1308	BREMBO	
3.6 Carrera	254	06/08 → 12/11	FCP4805	BREMBO				
3.6 Carrera	254	06/08 → 12/11				FRP3143	BREMBO	
3.6 Carrera 4	239	07/04 → 12/08	FRP3051	BREMBO				
3.6 Carrera 4	239	07/04 → 12/08				FCP1308	BREMBO	
3.6 Carrera 4	254	06/08 → 12/12	FCP4805	BREMBO				
3.6 Carrera 4	254	06/08 → 12/12				FRP3143	BREMBO	
3.6 GT2	390	09/07 →	FRP3075	BREMBO				
3.6 GT2	390	09/07 →				FRP3095	BREMBO	
3.6 GT2	390	09/07 →				FRP3143	BREMBO	
3.6 GT3	305	03/06 → 12/09	FRP3075	BREMBO				
3.6 GT3	305	03/06 → 12/09				FRP3143	BREMBO	For vehicles without ceramic discs
3.6 Turbo	353	03/06 → 12/09	FRP3075	BREMBO				
3.6 Turbo	353	03/06 → 12/09				FRP3095	BREMBO	
3.6 Turbo	353	03/06 → 12/09				FRP3143	BREMBO	
3.8 Carrera 4 GTS	300	06/09 → 12/12	FRP3050	BREMBO				
3.8 Carrera 4 GTS	300	06/09 → 12/12				FRP3051	BREMBO	
3.8 Carrera 4S	283	06/08 → 12/12	FRP3050	BREMBO				
3.8 Carrera 4S	283	06/08 → 12/12				FRP3051	BREMBO	
3.8 Carrera 4S	261	07/04 → 12/08	FRP3050	BREMBO				
3.8 Carrera 4S	261	07/04 → 12/08				FRP3051	BREMBO	
3.8 Carrera 4S	280	08/05 → 12/08	FRP3050	BREMBO				
3.8 Carrera 4S	280	08/05 → 12/08				FRP3051	BREMBO	
3.8 Carrera GTS	300	06/09 → 12/11	FRP3050	BREMBO				
3.8 Carrera GTS	300	06/09 → 12/11				FRP3051	BREMBO	
3.8 Carrera S	283	06/08 → 12/11	FRP3050	BREMBO				
3.8 Carrera S	283	06/08 → 12/11				FRP3051	BREMBO	
3.8 Carrera S	261	07/04 → 12/08	FRP3050	BREMBO				
3.8 Carrera S	261	07/04 → 12/08				FRP3051	BREMBO	
3.8 Carrera S	280	08/05 → 12/08	FRP3050	BREMBO				
3.8 Carrera S	280	08/05 → 12/08				FRP3051	BREMBO	
3.8 GT3	320	05/09 → 12/11	FRP3075	BREMBO				
3.8 GT3	320	05/09 → 12/11				FRP3095	BREMBO	
3.8 GT3	320	05/09 → 12/11				FRP3143	BREMBO	
3.8 GT3 CUP		01/05 → 12/09	FRP3096	BREMBO				
3.8 GT3 CUP		01/05 → 12/09				FRP3095	BREMBO	
3.8 GT3 CUP		01/05 → 12/09				FRP3143	BREMBO	
3.8 GT3 CUP		01/10 →	FRP3075	BREMBO				
3.8 GT3 CUP		01/10 →				FRP3143	BREMBO	
3.8 GT3 Cup Grand Am Spec		01/07 →	FRP3123	BREMBO				
3.8 GT3 Cup Grand Am Spec		01/07 →				FRP302	BREMBO	
3.8 GT3 RSR		01/07 →	FRP3031	BREMBO				
3.8 GT3 RSR		01/07 →				FRP1078	BREMBO	
3.8 GT3 RSR		12/09 →	FRP3075	BREMBO				
3.8 GT3 RSR		12/09 →				FRP3095	BREMBO	
3.8 GT3 RSR		12/09 →				FRP3143	BREMBO	
3.8 Turbo	368	09/09 → 12/12	FRP3075	BREMBO				
3.8 Turbo	368	09/09 → 12/12				FRP3143	BREMBO	For vehicles without ceramic discs
3.8 Turbo S	390	02/10 → 12/12	FRP3075	BREMBO				
3.8 Turbo S	390	02/10 → 12/12				FRP3143	BREMBO	For vehicles without ceramic discs

911 Convertible (991)

3.0 Carrera 4 GTS	331	03/17 →				FCP4713	BREMBO	For vehicles without ceramic discs
3.0 Carrera 4S	309	11/15 →	FCP4955	BREMBO	For vehicles without ceramic discs			
3.0 Carrera 4S	309	11/15 →				FCP4713	BREMBO	
3.0 Carrera GTS	331	03/17 →				FCP4713	BREMBO	For vehicles without ceramic discs
3.0 Carrera S	309	11/15 →	FCP4955	BREMBO	For vehicles without ceramic discs			
3.0 Carrera S	309	11/15 →				FCP4713	BREMBO	
3.4 Carrera	257	03/12 →	FCP4955	BREMBO				
3.4 Carrera	257	03/12 →				FCP4713	BREMBO	

For material availability see page 16-18 / Per la disponibilità materiali vedere a pagina 16-18



KW



...PORSCHE

...911 Convertible (991)

						NOTE			NOTE
3.4 Carrera	261	03/12 →	FCP4955	BREMBO					
3.4 Carrera	261	03/12 →					FCP4713	BREMBO	
3.4 Carrera 4	257	11/12 →	FCP4955	BREMBO					
3.4 Carrera 4	257	11/12 →					FCP4713	BREMBO	
3.4 Carrera 4	261	03/12 →	FCP4955	BREMBO					
3.4 Carrera 4	261	03/12 →					FCP4713	BREMBO	
3.8 Carrera 4 GTS	304	03/12 → 12/12	FRP3050	BREMBO					
3.8 Carrera 4 GTS	304	03/12 → 12/12					FRP3051	BREMBO	
3.8 Carrera 4S	294	11/12 →	FCP4955	BREMBO					
3.8 Carrera 4S / 4 GTS	316	11/12 →	FCP4955	BREMBO					
3.8 Carrera GTS	304	03/12 → 12/12	FRP3050	BREMBO					
3.8 Carrera GTS	304	03/12 → 12/12					FRP3051	BREMBO	
3.8 Carrera S	294	03/12 →	FCP4955	BREMBO					
3.8 Carrera S / GTS	316	07/12 →	FCP4955	BREMBO					
3.8 Turbo	383	12/13 →	FCP4664	BREMBO					
3.8 Turbo	383	12/13 →					FCP4665	BREMBO	
3.8 Turbo S	412	12/13 →	FCP4664	BREMBO					
3.8 Turbo S	412	12/13 →					FCP4665	BREMBO	

911 Convertible (996)

3.4 Carrera	221	02/98 → 09/01	FRP3051	BREMBO					
3.4 Carrera	221	02/98 → 09/01					FCP1308	BREMBO	
3.4 Carrera	235	05/01 → 08/05	FRP3051	BREMBO					
3.4 Carrera	235	05/01 → 08/05					FCP1308	BREMBO	
3.4 Carrera 4	221	02/98 → 09/01	FRP3051	BREMBO					
3.4 Carrera 4	221	02/98 → 09/01					FCP1308	BREMBO	
3.4 Carrera 4	235	05/01 → 08/05	FRP3051	BREMBO					
3.4 Carrera 4	235	05/01 → 08/05					FCP1308	BREMBO	
3.6 Carrera	235	10/01 → 08/05	FRP3051	BREMBO					
3.6 Carrera	235	10/01 → 08/05					FCP1308	BREMBO	
3.6 Carrera 4	235	10/01 → 08/05	FRP3051	BREMBO					
3.6 Carrera 4	235	10/01 → 08/05					FCP1308	BREMBO	
3.6 Carrera 4S	254	06/02 → 08/05	FRP3075	BREMBO	For vehicles without ceramic discs				
3.6 Carrera 4S	254	06/02 → 08/05					FRP3051	BREMBO	
3.6 Carrera S	254	06/02 → 08/05	FRP3051	BREMBO					
3.6 Carrera S	254	06/02 → 08/05					FCP1308	BREMBO	
3.6 S	331	08/04 → 08/05	FRP3050	BREMBO					
3.6 S	331	08/04 → 08/05					FRP3051	BREMBO	
3.6 Turbo 4	309	10/03 → 08/05	FRP3075	BREMBO	For vehicles without ceramic discs				
3.6 Turbo 4	309	10/03 → 08/05					FRP3051	BREMBO	
3.6 Turbo 4S	331	10/03 → 08/05	FRP3075	BREMBO	For vehicles without ceramic discs				
3.6 Turbo 4S	331	10/03 → 08/05					FRP3051	BREMBO	

911 Convertible (997)

3.6 Carrera	235	04/05 → 07/05	FRP3051	BREMBO					
3.6 Carrera	235	04/05 → 07/05					FCP1308	BREMBO	
3.6 Carrera	239	04/05 → 12/08	FRP3051	BREMBO					
3.6 Carrera	239	04/05 → 12/08					FCP1308	BREMBO	
3.6 Carrera	254	06/08 → 12/11	FCP4805	BREMBO					
3.6 Carrera	254	06/08 → 12/11					FRP3143	BREMBO	
3.6 Carrera 4	239	04/05 → 12/08	FRP3051	BREMBO					
3.6 Carrera 4	239	04/05 → 12/08					FCP1308	BREMBO	
3.6 Carrera 4	254	06/08 → 12/12	FCP4805	BREMBO					
3.6 Carrera 4	254	06/08 → 12/12					FRP3143	BREMBO	
3.6 Carrera 4	395	09/10 → 12/11	FCP4805	BREMBO					
3.8 Carrera 4 GTS	300	06/09 → 12/12	FRP3050	BREMBO					
3.8 Carrera 4 GTS	300	06/09 → 12/12					FRP3051	BREMBO	
3.8 Carrera 4S	283	06/08 → 12/12	FRP3050	BREMBO					
3.8 Carrera 4S	283	06/08 → 12/12					FRP3051	BREMBO	
3.8 Carrera 4S	261	04/05 → 12/08	FRP3050	BREMBO					
3.8 Carrera 4S	261	04/05 → 12/08					FRP3051	BREMBO	
3.8 Carrera 4S	280	08/05 → 12/08	FRP3050	BREMBO					
3.8 Carrera 4S	280	08/05 → 12/08					FRP3051	BREMBO	
3.8 Carrera GTS	300	06/09 → 12/11	FRP3050	BREMBO					
3.8 Carrera GTS	300	06/09 → 12/11					FRP3051	BREMBO	
3.8 Carrera S	283	06/08 → 12/11	FRP3050	BREMBO					
3.8 Carrera S	283	06/08 → 12/11					FRP3051	BREMBO	
3.8 Carrera S	261	04/05 → 12/08	FRP3050	BREMBO					
3.8 Carrera S	261	04/05 → 12/08					FRP3051	BREMBO	
3.8 Carrera S	280	08/05 → 12/08	FRP3050	BREMBO					
3.8 Carrera S	280	08/05 → 12/08					FRP3051	BREMBO	
3.8 Turbo	368	09/09 → 12/12	FRP3075	BREMBO					
3.8 Turbo	368	09/09 → 12/12					FRP3143	BREMBO	For vehicles without ceramic discs
3.8 Turbo S	390	02/10 → 12/12	FRP3075	BREMBO					
3.8 Turbo S	390	02/10 → 12/12					FRP3143	BREMBO	For vehicles without ceramic discs

For material availability see page 16-18 / Per la disponibilità materiali vedere a pagina 16-18

1170

FERODO

RACING

Updated on 17th Aug 2018

PORSCHE



KW



...PORSCHE					NOTE			NOTE
911 Targa (991)								
3.0 Carrera 4 GTS	331	03/17 →				FCP4713	BREMBO	For vehicles without ceramic discs
3.0 Carrera 4S	309	11/15 →	FCP4955	BREMBO	For vehicles without ceramic discs	FCP4713	BREMBO	
3.0 Carrera 4S	309	11/15 →						
3.4 Carrera 4	257	05/14 →	FCP4955	BREMBO				
3.4 Carrera 4	257	05/14 →				FCP4713	BREMBO	
3.8 Carrera 4S	294	05/14 →	FCP4955	BREMBO	For vehicles without ceramic discs			
3.8 Carrera 4S / 4 GTS	316	05/14 →	FCP4955	BREMBO	For vehicles without ceramic discs			
911 Targa (996)								
3.6	235	12/01 → 08/05	FRP3051	BREMBO				
3.6	235	12/01 → 08/05				FCP1308	BREMBO	
911 Targa (997)								
3.6 Carrera 4	239	07/06 → 12/08	FRP3051	BREMBO				
3.6 Carrera 4	239	07/06 → 12/08				FCP1308	BREMBO	
3.6 Carrera 4	254	10/08 → 12/12	FCP4805	BREMBO				
3.6 Carrera 4	254	10/08 → 12/12				FRP3143	BREMBO	
3.8 Carrera 4S	283	10/08 → 12/12	FRP3050	BREMBO				
3.8 Carrera 4S	283	10/08 → 12/12				FRP3051	BREMBO	
3.8 Carrera 4S	261	07/06 → 12/08	FRP3050	BREMBO				
3.8 Carrera 4S	261	07/06 → 12/08				FRP3051	BREMBO	
912								
1.6	66	01/65 → 12/69	FCP2	ATE				
1.6	66	01/65 → 12/69				FCP3	ATE	
914								
1.7 VW-Porsche 4	63	01/69 → 12/75	FCP2	ATE				
1.7 VW-Porsche 4	63	01/69 → 12/75				FCP93	ATE	
2.0 VW-Porsche 6	92	01/69 → 12/73	FCP3	ATE				
928								
4.5 16V	177	12/79 → 07/82	FCP256	ATE				
4.7 S 16V	221	01/81 → 08/83	FCP256	ATE				
4.7 S series 2 16V	221	09/83 → 07/86	FCP560	ATE				
4.7 S series 2 16V	221	09/83 → 07/86				FCP541	LUCAS/TRW	
5.0 S series 4,GT 32V	235, 243	09/86 → 05/92	FCP560	ATE				
5.0 S series 4,GT 32V	235, 243	09/86 → 05/92				FCP541	LUCAS/TRW	
5.4 GTS 32V	257	05/92 → 01/95	FCP891	ATE				
5.4 GTS 32V	257	05/92 → 01/95				FCP451	ATE	
944								
2.5 (Turbo)	220, 250	09/85 → 08/88	FCP451	ATE				
2.5 (Turbo)	220, 250	09/85 → 08/88				FCP451	ATE	
2.5 (Turbo)	250	09/88 → 05/92	FCP560	ATE				
2.5 (Turbo)	250	09/88 → 05/92				FCP451	ATE	
2.7 S2	121	01/88 → 08/90	FCP451	ATE				
2.7 S2	121	01/88 → 08/90				FCP451	ATE	
3.0 S2 16V	156	01/89 → 05/92	FCP451	ATE				
3.0 S2 16V	156	01/89 → 05/92				FCP451	ATE	
959								
2.9	330	01/85 → 12/91	FCP560	ATE				
2.9	330	01/85 → 12/91				FCP560	ATE	
968								
3.0 (Turbo)	224	03/93 → 11/95	FCP891	ATE				
3.0 (Turbo)	224	03/93 → 11/95				FCP451	ATE	
3.0 Club Sport 16V	176	01/93 → 10/95	FCP560	ATE				
3.0 Club Sport 16V	176	01/93 → 10/95				FCP451	ATE	
3.0 Not Club Sport 16V	176	01/93 → 10/95	FCP451	ATE				
3.0 Not Club Sport 16V	176	01/93 → 10/95				FCP451	ATE	
993								
Carrera		01/94 → 12/97	FCP560	ATE				
Carrera		01/94 → 12/97				FCP451	ATE	
Carrera RS		01/94 → 12/97	FCP891	ATE				
Carrera RS		01/94 → 12/97				FCP560	ATE	
GT2	316	03/95 →	FRP3042	BREMBO				
Turbo		01/94 → 12/97	FCP891	ATE				
Turbo		01/94 → 12/97				FCP560	ATE	

PORSCHE

For material availability see page 16-18 / Per la disponibilità materiali vedere a pagina 16-18



KW



PORSCHE

...PORSCHE					NOTE			NOTE
BOXSTER (981)								
2.7	195	04/12 →	FCP4805	BREMBO				
2.7	195	04/12 →				FCP1308	BREMBO	
GTS 3.4	243	02/14 →	FCP4805	BREMBO				
GTS 3.4	243	02/14 →				FCP1308	BREMBO	
S 3.4	232	04/12 →	FCP4805	BREMBO				
S 3.4	232	04/12 →				FCP1308	BREMBO	
Boxster (986)								
2.5	150	09/96 → 08/99	FCP1307	BREMBO				
2.5	150	09/96 → 08/99				FCP1308	BREMBO	
S 3.2	191	07/02 → 12/04	FRP3051	BREMBO				
S 3.2	191	07/02 → 12/04				FCP1308	BREMBO	
S 3.2	185	08/99 → 07/02	FRP3051	BREMBO				
S 3.2	185	08/99 → 07/02				FCP1308	BREMBO	
S 3.2	196	01/04 → 12/04	FRP3051	BREMBO				
S 3.2	196	01/04 → 12/04				FCP1308	BREMBO	
Boxster (987)								
2.7	180	07/06 →	FCP1307	BREMBO				
2.7	180	07/06 →				FCP1308	BREMBO	
2.9	188	06/09 → 12/11	FCP1307	BREMBO				
2.9	188	06/09 → 12/11				FCP1308	BREMBO	
S 3.2	206	11/04 → 12/06	FRP3051	BREMBO				
S 3.2	206	11/04 → 12/06				FCP1308	BREMBO	
S 3.4	217	07/06 → 12/09	FRP3051	BREMBO				
S 3.4	217	07/06 → 12/09				FCP1308	BREMBO	
S 3.4	223	08/08 → 12/09	FRP3051	BREMBO				
S 3.4	223	08/08 → 12/09				FCP1308	BREMBO	
S 3.4	228	06/09 → 12/11	FRP3051	BREMBO				
S 3.4	228	06/09 → 12/11				FCP1308	BREMBO	
BOXSTER Spyder								
3.8	276	07/15 →	FCP4805	BREMBO				
BOXSTER Spyder (987)								
3.4	235	06/10 → 12/11	FRP3051	BREMBO				
3.4	235	06/10 → 12/11				FCP1308	BREMBO	
3.4 RS 60	223	09/07 → 12/08	FRP3051	BREMBO				
3.4 RS 60	223	09/07 → 12/08				FCP1308	BREMBO	
Cayenne								
3.0 D	176	06/10 →	FCP4064	BREMBO	PR 1LL/1LU/1LH			
3.0 S Hybrid	245	06/10 →	FCP4064	BREMBO	PR 1LL/1LU/1LH			
3.6	220	06/10 →	FCP4064	BREMBO	PR 1LL/1LU/1LH			
4.8 S	294	06/10 →	FCP4064	BREMBO	PR 1LL/1LU/1LH			
4.8 Turbo	368	06/10 →	FCP4064	BREMBO	PR 1LL/1LU/1LH			
CAYENNE (955)								
3.0 TDI	176	02/09 → 09/10	FCP4467	BREMBO	NOT FOR CERAMIC DISCS			
3.2	184	10/03 → 09/07	FCP1625	BREMBO	17"			
3.2	184	10/03 → 09/07	FCP4064	BREMBO	19"			
3.2	184	10/03 → 09/07				FCP1308	BREMBO	Rim size 19"
3.6	213	02/07 → 09/10	FCP1625	BREMBO	17"			
3.6	213	02/07 → 09/10	FCP4064	BREMBO	19"			
3.6	213	02/07 → 09/10				FCP1308	BREMBO	Rim size 19"
4.5 Turbo S	368	01/04 →	FCP4064	BREMBO	19"			
4.5 Turbo S	368	01/04 →				FCP1308	BREMBO	19"
GTS 4.8	298	10/07 → 09/10	FCP4467	BREMBO	NOT FOR CERAMIC DISCS			
GTS 4.8	298	10/07 → 09/10				FCP1308	BREMBO	Rim size 19"
S 4.5	250	09/02 → 09/07	FCP1625	BREMBO	17"			
S 4.5	250	09/02 → 09/07	FCP4064	BREMBO	19"			
S 4.5	250	09/02 → 09/07	FCP4467	BREMBO	NOT FOR CERAMIC DISCS			
S 4.5	250	09/02 → 09/07				FCP1308	BREMBO	Rim size 19"
S 4.8	283	02/07 → 09/10	FCP1625	BREMBO	17"			
S 4.8	283	02/07 → 09/10	FCP4064	BREMBO	19"			
S 4.8	283	02/07 → 09/10				FCP1308	BREMBO	Rim size 19"
Turbo 4.5	331	09/02 → 09/07	FCP1626	BREMBO	17" / 18"			
Turbo 4.5	331	09/02 → 09/07	FCP4064	BREMBO	19"			
Turbo 4.5	331	09/02 → 09/07	FCP4467	BREMBO	NOT FOR CERAMIC DISCS			
Turbo 4.5	331	09/02 → 09/07				FCP1308	BREMBO	Rim size 19"
Turbo S 4.5	368	01/04 → 09/07	FCP4467	BREMBO	NOT FOR CERAMIC DISCS			
Turbo S 4.5	368	01/04 → 09/07				FCP1308	BREMBO	Rim size 19"
Turbo S 4.5	383	03/06 → 09/07	FCP4064	BREMBO	19"			
Turbo S 4.5	383	03/06 → 09/07	FCP4467	BREMBO	NOT FOR CERAMIC DISCS			
Turbo S 4.5	383	03/06 → 09/07				FCP1308	BREMBO	Rim size 19"
Turbo S 4.8	368	02/07 → 09/10	FCP4064	BREMBO	19"			

For material availability see page 16-18 / Per la disponibilità materiali vedere a pagina 16-18

1172



Updated on 17th Aug 2018



KW



...PORSCHE

...CAYENNE (955)

Turbo S 4.8	368	02/07 → 09/10	FCP4467	BREMBO	NOT FOR CERAMIC DISCS			
Turbo S 4.8	368	02/07 → 09/10				FCP1308	BREMBO	Rim size 19"
Turbo S 4.8	397	02/07 → 09/10				FCP1308	BREMBO	
Turbo S 4.8	404	08/08 → 09/10				FCP1308	BREMBO	

CAYMAN (981)

2.7	202	03/13 →	FCP4805	BREMBO				
2.7	202	03/13 →				FCP1308	BREMBO	
3.8 GT4	283	01/15 →	FCP4664	BREMBO				
3.8 GT4	283	01/15 →				FCP4665	BREMBO	
GTS 3.4	250	02/14 →	FCP4805	BREMBO				
GTS 3.4	250	02/14 →				FCP1308	BREMBO	
S 3.4	239	03/13 →	FCP4805	BREMBO				
S 3.4	239	03/13 →				FCP1308	BREMBO	

Cayman (987)

2.7	180	07/06 →	FCP1307	BREMBO				
2.7	180	07/06 →				FCP1308	BREMBO	
2.7	205	09/12 → 12/11	FCP4805	BREMBO				
2.9	195	02/09 → 12/12	FRP3051	BREMBO				
2.9	195	02/09 → 12/12				FCP1308	BREMBO	
R 3.4	243	11/10 → 12/12	FRP3051	BREMBO				
R 3.4	243	11/10 → 12/12				FCP1308	BREMBO	
S 3.4	217	11/05 → 12/09	FRP3051	BREMBO				
S 3.4	217	11/05 → 12/09				FCP1308	BREMBO	
S 3.4	242	09/12 → 12/11	FCP4805	BREMBO				
S 3.4	235	02/09 → 06/13	FRP3051	BREMBO				
S 3.4	235	02/09 → 06/13				FCP1308	BREMBO	

MACAN (95B)

2.0	185	10/15 →	FCP4064	BREMBO	For PR number : 1ZK			
2.0	185	10/15 →				FCP4050	LUCAS/TRW	For PR numbers : 1KY, 1KE, 1KD
3.0 GTS	265	10/15 →	FCP4064	BREMBO	For PR number : 1ZK			
3.0 GTS	265	10/15 →				FCP4050	LUCAS/TRW	For PR numbers : 1KE, 1KD
3.0 S	250	02/14 →	FCP4064	BREMBO	For PR number : 1ZK			
3.0 S	250	02/14 →				FCP4050	LUCAS/TRW	For PR number : 1KE
3.0 S Diesel	155	02/14 →	FCP4064	BREMBO	For PR number : 1ZK			
3.0 S Diesel	155	02/14 →				FCP4050	LUCAS/TRW	For PR number : 1KE
3.0 S Diesel	184	02/14 →	FCP4064	BREMBO	For PR number : 1ZK			
3.0 S Diesel	184	02/14 →				FCP4050	LUCAS/TRW	For PR number : 1KD, 1KE
3.6 Turbo	324	09/16 →	FCP4064	BREMBO	For PR number : 1LH			
3.6 Turbo	394	02/14 →	FCP4064	BREMBO	For PR number : 1ZK			
3.6 Turbo	394	02/14 →				FCP4050	LUCAS/TRW	For PR number : 1KE

PANAMERA (970)

3.0 4S	235	10/13 →	FCP4064	BREMBO	For vehicles without ceramic discs			
3.0 4S	235	10/13 →				FCP4713	BREMBO	For vehicles without ceramic discs
3.0 4S	309	07/13 →	FCP4064	BREMBO	For vehicles without ceramic discs			
3.0 4S	309	07/13 →				FCP4713	BREMBO	For vehicles without ceramic discs
3.0 D	155	08/11 →	FCP4064	BREMBO	For vehicles without ceramic discs			
3.0 D	155	08/11 →				FCP4713	BREMBO	For vehicles without ceramic discs
3.0 D	184	08/11 →	FCP4064	BREMBO	For vehicles without ceramic discs			
3.0 D	184	08/11 →				FCP4713	BREMBO	For vehicles without ceramic discs
3.0 D	221	01/14 →	FCP4064	BREMBO	For vehicles without ceramic discs			
3.0 D	221	01/14 →				FCP4713	BREMBO	For vehicles without ceramic discs
3.0 S	235	10/13 →	FCP4064	BREMBO	For vehicles without ceramic discs			
3.0 S	235	10/13 →				FCP4713	BREMBO	For vehicles without ceramic discs
3.0 S	309	07/13 →	FCP4064	BREMBO	For vehicles without ceramic discs			
3.0 S	309	07/13 →				FCP4713	BREMBO	For vehicles without ceramic discs
3.0 S E-Hybrid	245	03/11 →	FCP4064	BREMBO	For vehicles without ceramic discs			
3.0 S E-Hybrid	245	03/11 →				FCP4713	BREMBO	For vehicles without ceramic discs
3.0 S E-Hybrid	279	03/11 →	FCP4064	BREMBO	For vehicles without ceramic discs			
3.0 S E-Hybrid	279	03/11 →				FCP4713	BREMBO	For vehicles without ceramic discs
3.0 S E-Hybrid	306	07/13 →	FCP4064	BREMBO	For vehicles without ceramic discs			
3.0 S E-Hybrid	306	07/13 →				FCP4713	BREMBO	For vehicles without ceramic discs
3.6	220	05/10 →	FCP4064	BREMBO	without ceramic brakes			
3.6	220	05/10 →	FCP1641	ATE	PR: 1LN,1ZC,1ZD			
3.6	220	05/10 →	FCP1094	ATE	PR: 1ZG,1LR,1ZJ			
3.6	220	05/10 →	FCP4064	BREMBO	For vehicles without ceramic discs			
3.6	220	05/10 →				FCP1491	LUCAS/TRW	PR: 1KK,1KT,1KV,2EJ
3.6	220	05/10 →				FCP4713	BREMBO	For vehicles without ceramic discs
3.6	228	07/13 →	FCP4064	BREMBO	For vehicles without ceramic discs			
3.6	228	07/13 →				FCP4713	BREMBO	For vehicles without ceramic discs
3.6 4	220	05/10 →	FCP4064	BREMBO	For vehicles without ceramic discs			
3.6 4	220	05/10 →				FCP4713	BREMBO	For vehicles without ceramic discs
3.6 4	228	07/13 →	FCP4064	BREMBO	For vehicles without ceramic discs			
3.6 4	228	07/13 →				FCP4713	BREMBO	For vehicles without ceramic discs

For material availability see page 16-18 / Per la disponibilità materiali vedere a pagina 16-18

PORSCHE



KW



...PORSCHE

...PANAMERA (970)

					NOTE			NOTE
4.8	302	09/09 →	FCP4064	BREMBO	For vehicles without ceramic discs			
4.8	302	09/09 →				FCP4713	BREMBO	For vehicles without ceramic discs
4.8 4S	294	09/09 →	FCP4064	BREMBO	For vehicles without ceramic discs			
4.8 4S	294	09/09 →				FCP4713	BREMBO	For vehicles without ceramic discs
4.8 4S	302	09/09 →	FCP4064	BREMBO	For vehicles without ceramic discs			
4.8 4S	302	09/09 →				FCP4713	BREMBO	For vehicles without ceramic discs
4.8 GTS	316	01/12 →	FCP4064	BREMBO	For vehicles without ceramic discs			
4.8 GTS	316	01/12 →				FCP4713	BREMBO	For vehicles without ceramic discs
4.8 GTS	320	09/12 →	FCP4064	BREMBO	For vehicles without ceramic discs			
4.8 GTS	320	09/12 →				FCP4713	BREMBO	For vehicles without ceramic discs
4.8 GTS	324	07/13 →	FCP4064	BREMBO	For vehicles without ceramic discs			
4.8 GTS	324	07/13 →				FCP4713	BREMBO	For vehicles without ceramic discs
4.8 S	294	09/09 →	FCP4064	BREMBO	For vehicles without ceramic discs			
4.8 S	294	09/09 →				FCP4713	BREMBO	For vehicles without ceramic discs
4.8 Turbo	368	09/09 →	FCP4064	BREMBO	For vehicles without ceramic discs			
4.8 Turbo	368	09/09 →				FCP4713	BREMBO	For vehicles without ceramic discs
4.8 Turbo	382	07/13 →	FCP4064	BREMBO	For vehicles without ceramic discs			
4.8 Turbo	382	07/13 →				FCP4713	BREMBO	For vehicles without ceramic discs
4.8 Turbo	397	08/10 →	FCP4064	BREMBO	For vehicles without ceramic discs			
4.8 Turbo	397	08/10 →				FCP4713	BREMBO	For vehicles without ceramic discs
4.8 Turbo S	404	05/11 →	FCP4064	BREMBO	For vehicles without ceramic discs			
4.8 Turbo S	404	05/11 →				FCP4713	BREMBO	For vehicles without ceramic discs
4.8 Turbo S	419	01/14 →	FCP4064	BREMBO	For vehicles without ceramic discs			
4.8 Turbo S	419	01/14 →				FCP4713	BREMBO	For vehicles without ceramic discs

RELIANT

Scimitar

1.3 SS1	49	02/85 → 01/90	FCP840	LOCKHEED				
1.4 SS1	53	02/85 → 01/90	FCP840	LOCKHEED				
1.4 SST	53	01/90 → 04/92	FCP840	LOCKHEED				
1.6 SS1	71	02/85 → 01/90	FCP840	LOCKHEED				

RENAULT

11

1.1		12/86 → 12/89	FCP393	BENDIX				
1.1		12/86 → 12/89	FCP845	LUCAS/TRW				
1.1	35	06/83 → 12/89	FCP845	LUCAS/TRW				
1.1	35	06/83 → 12/89	FCP393	BENDIX				
1.1	35	07/86 → 11/86	FCP845	LUCAS/TRW				
1.1	35	07/86 → 11/86	FCP393	BENDIX				
1.2	40	10/86 → 12/89	FCP845	LUCAS/TRW				
1.2	40	10/86 → 12/89	FCP393	BENDIX				
1.4	44, 50	06/83 → 09/86	FCP845	LUCAS/TRW				
1.4	44, 50	06/83 → 09/86	FCP393	BENDIX				
1.4	43	10/86 → 12/89	FCP845	LUCAS/TRW				
1.4	43	10/86 → 12/89	FCP393	BENDIX				
1.4	44	10/86 → 12/89	FCP845	LUCAS/TRW				
1.4	44	10/86 → 12/89	FCP393	BENDIX				
1.4	50	10/86 → 12/89	FCP845	LUCAS/TRW				
1.4	50	10/86 → 12/89	FCP393	BENDIX				
1.4 (Turbo)	85	01/84 → 09/86	FCP845	LUCAS/TRW				
1.4 (Turbo)	85	01/84 → 09/86	FCP393	BENDIX				
1.4 (Turbo)	85	01/84 → 09/86				FCP558	BENDIX	
1.4 (Turbo)	85	10/86 → 06/89	FCP845	LUCAS/TRW				
1.4 (Turbo)	85	10/86 → 06/89	FCP393	BENDIX				
1.4 (Turbo)	85	10/86 → 06/89				FCP558	BENDIX	
1.6 D	40	06/83 → 12/89	FCP845	LUCAS/TRW				
1.6 D	40	06/83 → 12/89	FCP393	BENDIX				
1.6 D	40	10/86 → 12/89	FCP845	LUCAS/TRW				
1.6 D	40	10/86 → 12/89	FCP393	BENDIX				
1.7	54, 55	10/86 → 12/89	FCP845	LUCAS/TRW				
1.7	54, 55	10/86 → 12/89	FCP393	BENDIX				
1.7	60, 66	06/83 → 09/86	FCP845	LUCAS/TRW				
1.7	60, 66	06/83 → 09/86	FCP393	BENDIX				

12

1.3 (1170)	37	07/75 → 04/80	FCP72	BENDIX				
1.3 (1170)	40	10/69 → 08/80	FCP72	BENDIX				
1.3 TS (1177, 1337)	44	08/72 → 08/80	FCP72	BENDIX				
1.4	49	08/76 → 05/79	FCP72	BENDIX				
1.6 Gordini		06/70 → 12/74	FCP72	BENDIX				

For material availability see page 16-18 / Per la disponibilità materiali vedere a pagina 16-18

1174

FERODO

RACING

Updated on 17th Aug 2018

PORSCHE



KW

**...RENAULT****...12**

1.6 Gordini 06/70 → 12/74

FCP72

BENDIX

14

1.2 41 04/76 → 12/84 FCP72 BENDIX

1.2 42 04/76 → 12/84 FCP72 BENDIX

1.2 51 04/76 → 12/84 FCP72 BENDIX

1.4 44, 52 04/76 → 12/84 FCP72 BENDIX

15

1.3 43 07/71 → 12/79 FCP72 BENDIX

1.6 TS 63 07/71 → 12/75 FCP72 BENDIX

1.6 TS 63 07/71 → 12/75 FCP72 BENDIX

16 (115_)

1.5 01/68 → 12/80 FCP72 BENDIX

1.6 TL (1152, 1153, 1157) 48 01/71 → 08/80 FCP72 BENDIX

1.6 TS (1151, 1154) 61 09/68 → 08/80 FCP72 BENDIX

1.6 TX (1156) 68 06/74 → 08/80 FCP72 BENDIX

17

1.6 66 03/72 → 10/80 FCP72 BENDIX

1.6 68 06/74 → 08/79 FCP72 BENDIX

1.6 (R177) 01/71 → 12/80 FCP72 BENDIX

1.6 Gordini 10/74 → 12/79 FCP72 BENDIX

1.6 Gordini 10/74 → 12/79 FCP72 BENDIX

1.7 (R177) 01/71 → 12/80 FCP72 BENDIX

18

1.4 i R1340/R1350 46 01/85 → 12/86 FCP393 BENDIX

1.4 i R1340/R1350 46 01/85 → 12/86 FCP845 LUCAS/TRW

1.4 R1340/R1350 46 04/78 → 06/82 FCP72 BENDIX

1.4 R1340/R1350 46 07/82 → 12/86 FCP845 LUCAS/TRW

1.6 70, 81 04/78 → 06/82 FCP393 BENDIX

1.6 70, 81 04/78 → 06/82 FCP845 LUCAS/TRW

1.6 92 07/82 → 12/86 FCP393 BENDIX

1.6 92 07/82 → 12/86 FCP845 LUCAS/TRW

1.6 (Turbo) 80, 92 01/82 → 12/86 FCP393 BENDIX

1.6 (Turbo) 80, 92 01/82 → 12/86 FCP845 LUCAS/TRW

1.6 (Turbo) 80, 92 01/82 → 12/86 FCP72 BENDIX

1.6 i R1341/R1351 52, 58 01/85 → 12/86 FCP393 BENDIX

1.6 i R1341/R1351 52, 58 01/85 → 12/86 FCP845 LUCAS/TRW

1.6 i TS 52, 58 01/85 → 07/86 FCP393 BENDIX

1.6 i TS 52, 58 01/85 → 07/86 FCP845 LUCAS/TRW

1.6 R1341/R1351 52, 58 07/82 → 12/86 FCP393 BENDIX

1.6 R1341/R1351 52, 58 07/82 → 12/86 FCP845 LUCAS/TRW

1.6 R1341/R1351 58 04/78 → 06/82 FCP72 BENDIX

1.6 R1342 70 07/82 → 12/86 FCP393 BENDIX

1.6 R1342 70 07/82 → 12/86 FCP845 LUCAS/TRW

1.6 SW Estate Turbo (R1355) 01/82 → 12/86 FCP393 BENDIX

1.6 SW Estate Turbo (R1355) 01/82 → 12/86 FCP845 LUCAS/TRW

1.6 SW Estate Turbo (R1355) 01/82 → 12/86 FCP72 BENDIX

1.6 TS 52, 58 05/82 → 07/86 FCP393 BENDIX

1.6 TS 52, 58 05/82 → 07/86 FCP845 LUCAS/TRW

1.6 TS 70 05/82 → 07/86 FCP393 BENDIX

1.6 TS 70 05/82 → 07/86 FCP845 LUCAS/TRW

2.0 i R1343/R1353 77 01/83 → 12/86 FCP393 BENDIX

2.0 i R1343/R1353 77 01/83 → 12/86 FCP845 LUCAS/TRW

2.0 R1343/R1353 77 07/81 → 12/86 FCP393 BENDIX

2.0 R1343/R1353 77 07/81 → 12/86 FCP845 LUCAS/TRW

2.1 D R1344/R1354 48 01/85 → 12/86 FCP845 LUCAS/TRW

2.1 D R1344/R1354 48 01/85 → 12/86 FCP393 BENDIX

2.1 D R1344/R1354 48 07/80 → 12/86 FCP845 LUCAS/TRW

2.1 D R1344/R1354 48 07/80 → 12/86 FCP393 BENDIX

2.1 TD R1346/R1356 65 01/83 → 12/86 FCP845 LUCAS/TRW

2.1 TD R1346/R1356 65 01/83 → 12/86 FCP393 BENDIX

19

1.2 i , Chamade 05/92 → 12/96 FCP393 BENDIX

1.2 i , Chamade 05/92 → 12/96 FCP845 LUCAS/TRW

1.2 i , Chamade 40 09/88 → 04/91 FCP845 LUCAS/TRW

1.2 i , Chamade 40 09/88 → 04/92 FCP393 BENDIX

1.2 i , Chamade 40 05/91 → 04/92 FCP845 LUCAS/TRW

1.7 Chamade 54, 66 09/88 → 04/92 FCP845 LUCAS/TRW

1.7 Chamade 54, 66 09/88 → 04/92 FCP393 BENDIX

1.7 Chamade 54, 66 09/88 → 04/92 FCP558 BENDIX ABS

1.7 Chamade D53C TXE/RT 69, 70 01/91 → 04/92 FCP845 LUCAS/TRW

For material availability see page 16-18 / Per la disponibilità materiali vedere a pagina 16-18

RENAULT



KW



...RENAULT

...19

					NOTE			NOTE
1.7 Chamade D53C TXE/RT	69, 70	01/91 → 04/92	FCP393	BENDIX				
1.7 Chamade D53C TXE/RT	69, 70	01/91 → 04/92				FCP558	BENDIX	
1.7 i , Chamade	54, 66	05/91 → 04/92	FCP845	LUCAS/TRW				
1.7 i , Chamade	54, 66	05/91 → 04/92	FCP393	BENDIX				
1.7 i ,Chamade D53C TXE/RT	69, 70	05/92 → 12/95	FCP845	LUCAS/TRW				
1.7 i ,Chamade D53C TXE/RT	69, 70	05/92 → 12/95	FCP393	BENDIX				
1.7 i ,Chamade D53C TXE/RT	69, 70	05/92 → 12/95				FCP558	BENDIX	
1.8 Chamade	81, 104	09/88 → 12/95	FCP845	LUCAS/TRW				
1.8 Chamade	81, 104	09/88 → 12/95	FCP393	BENDIX				
1.8 Chamade	81, 104	09/88 → 12/95				FCP558	BENDIX	ABS
1.8 Chamade B/C/L53Y	81	09/88 → 11/95	FCP845	LUCAS/TRW				
1.8 Chamade B/C/L53Y	81	09/88 → 11/95	FCP393	BENDIX				
1.8 Chamade B/C/L53Y	81	09/88 → 11/95				FCP558	BENDIX	ABS
1.8 Chamade RT (D53Y)	81	09/88 → 11/95	FCP845	LUCAS/TRW				
1.8 Chamade RT (D53Y)	81	09/88 → 11/95	FCP393	BENDIX				
1.8 Chamade RT (D53Y)	81	09/88 → 11/95				FCP558	BENDIX	ABS
1.8 i , Chamade B/C/L53Y	81	05/91 → 04/92	FCP845	LUCAS/TRW				
1.8 i , Chamade B/C/L53Y	81	05/91 → 04/92	FCP393	BENDIX				
1.8 i , Chamade B/C/L53Y	81	05/92 → 11/95	FCP845	LUCAS/TRW				
1.8 i , Chamade B/C/L53Y	81	05/92 → 11/95	FCP393	BENDIX				
1.8 i , D53Y Chamade RT	81	05/91 → 04/92	FCP845	LUCAS/TRW				
1.8 i , D53Y Chamade RT	81	05/91 → 04/92	FCP393	BENDIX				
1.8 i ,Chamade 16V	100, 104	01/90 → 12/96	FCP393	BENDIX				
1.8 i ,Chamade 16V	100, 104	01/90 → 12/96				FCP558	BENDIX	
1.9 D , Chamade	47	05/91 → 04/92	FCP845	LUCAS/TRW				
1.9 D , Chamade	47	05/91 → 04/92	FCP393	BENDIX				
1.9 D , Chamade	47	05/92 → 12/96	FCP845	LUCAS/TRW				
1.9 D, Chamade	47	09/88 → 12/96	FCP845	LUCAS/TRW				
1.9 D, Chamade	47	09/88 → 12/96	FCP393	BENDIX				
1.9 D, Chamade	47	09/88 → 12/96				FCP558	BENDIX	ABS
1.9 TD , Chamade	68	01/90 → 12/96	FCP845	LUCAS/TRW				
1.9 TD , Chamade	68	05/91 → 04/92	FCP845	LUCAS/TRW				
1.9 TD , Chamade	68	05/91 → 04/92	FCP393	BENDIX				
1.9 TD , Chamade	68	05/92 → 12/96	FCP845	LUCAS/TRW				
1.9 TD , Chamade	68	05/92 → 12/96	FCP393	BENDIX				

19 I Chamade (L53_)

1.4	55	09/90 → 04/92	FCP393	BENDIX				
1.4	55	09/90 → 04/92	FCP845	LUCAS/TRW				
1.4	55	09/90 → 04/92				FCP558	BENDIX	ABS
1.4	57	07/88 → 08/90	FCP393	BENDIX				
1.4	57	07/88 → 08/90	FCP845	LUCAS/TRW				
1.4	57	07/88 → 08/90				FCP558	BENDIX	ABS

19 II Chamade (L53_)

1.4	44	09/90 → 04/92	FCP393	BENDIX				
1.4	44	09/90 → 04/92	FCP845	LUCAS/TRW				
1.4	44	09/90 → 04/92				FCP558	BENDIX	ABS

20

1.6	66	11/75 → 06/80	FCP72	BENDIX				
1.6 (R1271)	66	07/80 → 12/84	FCP393	BENDIX				
1.6 (R1271)	66	07/80 → 12/84	FCP845	LUCAS/TRW				
1.6 i R1271		01/82 → 12/84	FCP393	BENDIX				
1.6 i R1271		01/82 → 12/84	FCP845	LUCAS/TRW				
2.0	77, 80	07/80 → 01/85	FCP393	BENDIX				
2.0	77, 80	07/80 → 01/85	FCP845	LUCAS/TRW				
2.1 D	48	12/79 → 01/85	FCP393	BENDIX				
2.1 D	48	12/79 → 01/85	FCP845	LUCAS/TRW				
2.1 TD	63	12/79 → 01/85	FCP393	BENDIX				
2.1 TD	63	12/79 → 01/85	FCP845	LUCAS/TRW				
2.2	85	08/81 → 01/85	FCP393	BENDIX				

21

1.4	50	02/86 → 12/94	FCP393	BENDIX				
1.4	50	02/86 → 12/94	FCP845	LUCAS/TRW				
1.4 i	50	03/91 → 12/94	FCP393	BENDIX				
1.4 i	50	03/91 → 12/94	FCP845	LUCAS/TRW				
1.7 i TL/GTL		03/91 → 12/94	FCP393	BENDIX				
1.7 i TL/GTL		03/91 → 12/94	FCP845	LUCAS/TRW				
1.7 i TS/GTS/RS/TSE		03/91 → 12/94	FCP393	BENDIX				
1.7 i TS/GTS/RS/TSE		03/91 → 12/94	FCP845	LUCAS/TRW				
1.7 Nevada, Savana TL/GTL		02/87 → 12/94	FCP393	BENDIX				
1.7 Nevada, Savana TL/GTL		02/87 → 12/94	FCP845	LUCAS/TRW				
1.7 Nevada, Savana TS/GTS/RS/TSE		02/87 → 12/94	FCP393	BENDIX				
1.7 Nevada, Savana TS/GTS/RS/TSE		02/87 → 12/94	FCP845	LUCAS/TRW				
1.7 TL/GTL		02/86 → 12/94	FCP393	BENDIX				

For material availability see page 16-18 / Per la disponibilità materiali vedere a pagina 16-18

1176

FERODO

RACING

Updated on 17th Aug 2018

RENAULT



KW

**...RENAULT****...21**

					NOTE				NOTE
1.7 TL/GTL	02/86 → 12/94	FCP845	LUCAS/TRW						
1.7 TL/GTL	03/87 → 02/91	FCP393	BENDIX						
1.7 TL/GTL	03/87 → 02/91	FCP845	LUCAS/TRW						
1.7 TS/GTS/RS/TSE	02/86 → 12/94	FCP393	BENDIX						
1.7 TS/GTS/RS/TSE	02/86 → 12/94	FCP845	LUCAS/TRW						
1.7 TS/GTS/RS/TSE	03/87 → 02/91	FCP393	BENDIX						
1.7 TS/GTS/RS/TSE	03/87 → 02/91	FCP845	LUCAS/TRW						
1.9 D	48 05/89 → 12/94	FCP393	BENDIX						
1.9 D	48 05/89 → 12/94	FCP845	LUCAS/TRW						
1.9 D Nevada, Savana	05/89 → 12/94	FCP393	BENDIX						
1.9 D Nevada, Savana	05/89 → 12/94	FCP845	LUCAS/TRW						
2.0 Nevada, Savana	85, 99 07/86 → 12/94				FCP72	BENDIX	ABS		
2.0 Nevada, Savana	85, 99 07/86 → 12/94				FCP878	BREMBO	ABS		
2.0 Turbo L485	06/87 → 12/93				FCP878	BREMBO			
2.0 TXI	99 02/86 → 12/94				FCP72	BENDIX	ABS		
2.0 TXI	99 02/86 → 12/94				FCP878	BREMBO	ABS		
2.1 D	51 02/86 → 12/94	FCP393	BENDIX						
2.1 D	51 02/86 → 12/94	FCP845	LUCAS/TRW						
2.1 D	51 02/86 → 12/94				FCP878	BREMBO	ABS		
2.1 D	51 02/86 → 12/94				FCP72	BENDIX	ABS		
2.1 D	53 02/86 → 12/94	FCP393	BENDIX						
2.1 D	53 02/86 → 12/94	FCP845	LUCAS/TRW						
2.1 D	53 02/86 → 12/94				FCP878	BREMBO	ABS		
2.1 D	53 02/86 → 12/94				FCP72	BENDIX	ABS		
2.1 D	65 02/86 → 12/94	FCP393	BENDIX						
2.1 D	65 02/86 → 12/94	FCP845	LUCAS/TRW						
2.1 D	65 02/86 → 12/94				FCP878	BREMBO	ABS		
2.1 D	65 02/86 → 12/94				FCP72	BENDIX	ABS		
2.1 TD	65 02/86 → 12/94	FCP393	BENDIX						
2.1 TD	65 02/86 → 12/94	FCP845	LUCAS/TRW						
2.1 TD	65 02/86 → 12/94				FCP72	BENDIX	ABS		
2.1 TD	65 02/86 → 12/94				FCP878	BREMBO	ABS		
2.1 TD	65 03/87 → 12/94	FCP393	BENDIX						
2.1 TD	65 03/87 → 12/94	FCP845	LUCAS/TRW						
2.2	75 07/86 → 12/94				FCP878	BREMBO	ABS		
2.2	75 07/86 → 12/94				FCP72	BENDIX	ABS		
2.2	79 07/86 → 12/94				FCP878	BREMBO	ABS		
2.2	79 07/86 → 12/94				FCP72	BENDIX	ABS		
2.2	81 07/86 → 12/94				FCP878	BREMBO	ABS		
2.2	81 07/86 → 12/94				FCP72	BENDIX	ABS		
2.2 Nevada, Savana	79 06/88 → 12/94				FCP72	BENDIX	ABS		
2.2 Nevada, Savana	79 06/88 → 12/94				FCP878	BREMBO	ABS		

21 Estate (K48_)

2.1 D (K/S486)	48 10/86 → 09/90	FCP393	BENDIX						
2.1 D (K/S486)	48 10/86 → 09/90	FCP845	LUCAS/TRW						
2.1 D (K/S486)	48 10/86 → 09/90				FCP878	BREMBO	ABS		
2.1 D (K/S486)	48 10/86 → 09/90				FCP72	BENDIX	ABS		
2.1 D (K/S48V, K/S480)	53 08/89 → 12/92	FCP393	BENDIX						
2.1 D (K/S48V, K/S480)	53 08/89 → 12/92	FCP845	LUCAS/TRW						
2.1 D (K/S48V, K/S480)	53 08/89 → 12/92				FCP878	BREMBO	ABS		
2.1 D (K/S48V, K/S480)	53 08/89 → 12/92				FCP72	BENDIX	ABS		
2.1 D (K480)	51 02/92 → 09/95	FCP393	BENDIX						
2.1 D (K480)	51 02/92 → 09/95	FCP845	LUCAS/TRW						
2.1 D (K480)	51 02/92 → 09/95				FCP878	BREMBO	ABS		
2.1 D (K480)	51 02/92 → 09/95				FCP72	BENDIX	ABS		
2.1 D 4x4 (K486)	48 10/88 → 05/92	FCP393	BENDIX						
2.1 D 4x4 (K486)	48 10/88 → 05/92	FCP845	LUCAS/TRW						
2.1 D 4x4 (K486)	48 10/88 → 05/92				FCP878	BREMBO	ABS		
2.1 D 4x4 (K486)	48 10/88 → 05/92				FCP72	BENDIX	ABS		
2.1 Turbo-D (K48A, K48W, K487, K488)	65 10/86 → 11/93	FCP393	BENDIX						
2.1 Turbo-D (K48A, K48W, K487, K488)	65 10/86 → 11/93	FCP845	LUCAS/TRW						
2.1 Turbo-D (K48A, K48W, K487, K488)	65 10/86 → 11/93				FCP878	BREMBO	ABS		
2.1 Turbo-D (K48A, K48W, K487, K488)	65 10/86 → 11/93				FCP72	BENDIX	ABS		

25

2.0 i TI/TXI (B294)	47, 51 01/90 → 12/92	FCP845	LUCAS/TRW						
2.0 i TI/TXI (B294)	47, 51 01/90 → 12/92				FCP72	BENDIX	ABS		
2.1 D	47, 51 02/84 → 12/92	FCP845	LUCAS/TRW						
2.1 D	47, 51 02/84 → 12/92	FCP406	LUCAS/TRW	ABS					
2.1 D	47, 51 02/84 → 12/92				FCP72	BENDIX	ABS		
2.1 D	47, 51 06/88 → 12/92	FCP845	LUCAS/TRW						
2.1 TD	63 02/84 → 12/92	FCP845	LUCAS/TRW						
2.1 TD	63 02/84 → 12/92	FCP406	LUCAS/TRW	ABS					
2.1 TD	63 02/84 → 12/92				FCP72	BENDIX	ABS		
2.1 TD	63 06/88 → 12/92	FCP845	LUCAS/TRW						
2.1 TD	63 06/88 → 12/92	FCP406	LUCAS/TRW						

For material availability see page 16-18 / Per la disponibilità materiali vedere a pagina 16-18



KW



...RENAULT

...25

						NOTE			NOTE
2.2	79	02/84 → 12/92	FCP845	LUCAS/TRW					
2.2	79	02/84 → 12/92	FCP406	LUCAS/TRW	ABS				
2.2	79	02/84 → 12/92				FCP72	BENDIX	ABS	
2.2	79	06/88 → 12/92	FCP845	LUCAS/TRW					
2.2	79	06/88 → 12/92	FCP406	LUCAS/TRW					
2.5 V6 (Turbo)	133	10/84 → 06/87	FCP406	LUCAS/TRW					
2.5 V6 (Turbo)	133	10/84 → 06/87				FCP72	BENDIX		
2.5 V6 (Turbo)	133	07/87 → 05/90	FCP845	LUCAS/TRW					
2.5 V6 (Turbo)	133	07/87 → 05/90				FCP72	BENDIX		
2.5 V6 (Turbo)	134, 151	03/85 → 12/92	FCP406	LUCAS/TRW					
2.5 V6 (Turbo)	134, 151	03/85 → 12/92				FCP72	BENDIX		
2.7 V6i (B293/298-B29F)	104	10/85 → 12/92	FCP406	LUCAS/TRW					
2.7 V6i (B293/298-B29F)	104	10/85 → 12/92				FCP72	BENDIX		

25 (B29_)

2.0 (B297)	74	04/84 → 12/92	FCP406	LUCAS/TRW	ABS				
2.0 (B297)	74	04/84 → 12/92	FCP845	LUCAS/TRW					
2.0 (B297)	74	04/84 → 12/92				FCP72	BENDIX	ABS	
2.0 12V	103	06/88 → 12/93	FCP406	LUCAS/TRW	ABS				
2.0 12V	103	06/88 → 12/93	FCP845	LUCAS/TRW					
2.0 12V	103	06/88 → 12/93				FCP72	BENDIX	ABS	
2.8 V6 (B293)	115	06/87 → 02/90	FCP406	LUCAS/TRW					
2.8 V6 (B293)	115	06/87 → 02/90				FCP72	BENDIX		
2.8 V6 Injection (B29A)	100	06/86 → 02/88	FCP406	LUCAS/TRW					
2.8 V6 Injection (B29A)	100	06/86 → 02/88				FCP72	BENDIX		
2.8 V6 Injection (B29F)	110	06/87 → 12/92	FCP406	LUCAS/TRW					
2.8 V6 Injection (B29F)	110	06/87 → 12/92				FCP72	BENDIX		
2.9 V6	100	01/84 → 12/92	FCP406	LUCAS/TRW					
2.9 V6	100	01/84 → 12/92				FCP72	BENDIX		
2.9 V6	104	01/84 → 12/92	FCP406	LUCAS/TRW					
2.9 V6	104	01/84 → 12/92				FCP72	BENDIX		
2.9 V6	110	01/84 → 12/92	FCP406	LUCAS/TRW					
2.9 V6	110	01/84 → 12/92				FCP72	BENDIX		

30

2.1 TD	63	09/82 → 12/84	FCP845	LUCAS/TRW					
--------	----	---------------	--------	-----------	--	--	--	--	--

4

0.9		01/82 → 12/92	FCP72	BENDIX					
1.0	30	07/86 → 12/92	FCP72	BENDIX					
1.1	25, 33	07/86 → 12/92	FCP72	BENDIX					

5

0.8 L, TL, TS, GTL	21	01/71 → 02/85	FCP72	BENDIX	alt Disc				
1.0	31	10/84 →	FCP881	BENDIX					
1.0 L, TL, TS, GTL	31	01/71 → 09/84	FCP72	BENDIX					
1.1	33	04/79 → 12/81	FCP72	BENDIX					
1.1	34	07/82 → 09/84	FCP72	BENDIX					
1.1	34	07/82 → 01/90	FCP393	BENDIX					
1.1	34	10/84 → 01/90	FCP881	BENDIX					
1.1	34	10/84 → 01/90	FCP845	LUCAS/TRW					
1.3		01/72 → 12/74	FCP72	BENDIX					
1.3	43	01/75 → 08/84	FCP72	BENDIX					
1.4	43	10/84 → 01/90	FCP393	BENDIX					
1.4	43	10/84 → 01/90	FCP881	BENDIX					
1.4	43	10/84 → 01/90	FCP845	LUCAS/TRW					
1.4	44	10/84 → 01/90	FCP393	BENDIX					
1.4	44	10/84 → 01/90	FCP845	LUCAS/TRW					
1.4	44	10/84 → 01/90	FCP881	BENDIX					
1.4	46	07/82 → 09/84	FCP72	BENDIX					
1.4	49	10/84 → 01/90	FCP393	BENDIX					
1.4	49	10/84 → 01/90	FCP845	LUCAS/TRW					
1.4	49	10/84 → 01/90	FCP881	BENDIX					
1.4	52	10/84 → 01/90	FCP393	BENDIX					
1.4	52	10/84 → 01/90	FCP845	LUCAS/TRW					
1.4	52	10/84 → 01/90	FCP881	BENDIX					
1.4	68	01/75 → 12/81	FCP72	BENDIX					
1.4	85	10/84 → 01/90	FCP393	BENDIX					
1.4	85	10/84 → 01/90	FCP845	LUCAS/TRW					
1.4	85	10/84 → 01/90	FCP881	BENDIX					
1.4 Gordini (Turbo)	81	06/80 → 12/85	FCP72	BENDIX					

For material availability see page 16-18 / Per la disponibilità materiali vedere a pagina 16-18



KW

**...RENAULT****5 Super**

				NOTE			NOTE
1.0	31	02/85 → 07/93	FCP393	BENDIX			
1.0	31	02/85 → 07/93	FCP881	BENDIX			
1.0	31	02/85 → 07/93	FCP845	LUCAS/TRW			
1.1	34	02/85 → 06/89	FCP393	BENDIX			
1.1	34	02/85 → 06/89	FCP881	BENDIX			
1.1	34	02/85 → 06/89	FCP845	LUCAS/TRW			
1.2	40	07/86 → 12/90	FCP393	BENDIX			
1.2	40	07/86 → 12/90	FCP881	BENDIX			
1.2	40	07/86 → 12/90	FCP845	LUCAS/TRW			
1.6 D	40	02/85 → 12/96	FCP393	BENDIX			
1.6 D	40	02/85 → 12/96	FCP881	BENDIX			
1.6 D	40	02/85 → 12/96	FCP845	LUCAS/TRW			
1.6 GT (Turbo)		02/86 → 10/91	FCP845	LUCAS/TRW			
1.6 GT (Turbo)		02/86 → 10/91			FCP558	BENDIX	
1.7	55	07/86 → 01/92	FCP845	LUCAS/TRW			
1.7	55	07/86 → 01/92	FCP881	BENDIX			
1.7	55	07/86 → 01/92	FCP393	BENDIX			
1.7	55	07/86 → 01/92			FCP558	BENDIX	
1.7	66	07/86 → 01/92	FCP845	LUCAS/TRW			
1.7	66	07/86 → 01/92	FCP881	BENDIX			
1.7	66	07/86 → 01/92	FCP393	BENDIX			
1.7	66	07/86 → 01/92			FCP558	BENDIX	
1.7	70	07/86 → 01/92	FCP845	LUCAS/TRW			
1.7	70	07/86 → 01/92	FCP881	BENDIX			
1.7	70	07/86 → 01/92	FCP393	BENDIX			
1.7	70	07/86 → 01/92			FCP558	BENDIX	

6

0.8	26	01/70 →	FCP72	BENDIX			
1.1	34	01/70 →	FCP72	BENDIX			

9

1.1	35	01/82 → 09/86	FCP845	LUCAS/TRW			
1.1	35	01/82 → 09/86	FCP393	BENDIX			
1.2	40	10/86 → 12/89	FCP845	LUCAS/TRW			
1.2	40	10/86 → 12/89	FCP393	BENDIX			
1.4	44, 50	01/82 → 09/86	FCP845	LUCAS/TRW			
1.4	44, 50	01/82 → 09/86	FCP393	BENDIX			
1.4	43	10/86 → 12/89	FCP845	LUCAS/TRW			
1.4	43	10/86 → 12/89	FCP393	BENDIX			
1.4	44	10/86 → 12/89	FCP845	LUCAS/TRW			
1.4	44	10/86 → 12/89	FCP393	BENDIX			
1.4	50	10/86 → 12/89	FCP845	LUCAS/TRW			
1.4	50	10/86 → 12/89	FCP393	BENDIX			
1.4 (Turbo)	85	02/86 → 12/88	FCP845	LUCAS/TRW			
1.4 (Turbo)	85	02/86 → 12/88	FCP393	BENDIX			
1.4 (Turbo)	85	02/86 → 12/88			FCP558	BENDIX	
1.6 D	40	01/82 → 12/89	FCP845	LUCAS/TRW			
1.6 D	40	01/82 → 12/89	FCP393	BENDIX			
1.7	60, 66	01/82 → 09/86	FCP845	LUCAS/TRW			
1.7	60, 66	01/82 → 09/86	FCP393	BENDIX			
1.7	54	10/86 → 12/89	FCP845	LUCAS/TRW			
1.7	54	10/86 → 12/89	FCP393	BENDIX			
1.7	66	10/86 → 12/89	FCP845	LUCAS/TRW			
1.7	66	10/86 → 12/89	FCP393	BENDIX			
1.7	70	10/86 → 12/89	FCP845	LUCAS/TRW			
1.7	70	10/86 → 12/89	FCP393	BENDIX			

Avantime

2.0i 16V	120	09/01 →			FCP1491	LUCAS/TRW	
3.0i V6	152	09/01 →			FCP1491	LUCAS/TRW	

Clio

1.0		06/90 → 05/95	FCP881	BENDIX			
1.1	35	06/90 → 05/95	FCP881	BENDIX			
1.1	35	06/90 → 05/95	FCP845	LUCAS/TRW			
1.1 i	35	04/91 → 05/95	FCP845	LUCAS/TRW			
1.2	40, 44	09/90 → 02/98	FCP393	BENDIX			
1.2	40, 44	09/90 → 02/98	FCP845	LUCAS/TRW			
1.2 i	40, 44	04/91 → 03/96	FCP845	LUCAS/TRW			
1.2 i	40, 44	04/91 → 02/98	FCP393	BENDIX			
1.2 i	40, 44	04/96 → 12/96	FCP845	LUCAS/TRW			
1.4	55, 57	06/90 → 02/98	FCP393	BENDIX			
1.4	55, 57	06/90 → 02/98	FCP845	LUCAS/TRW			
1.4 i	55, 57	04/91 → 03/96	FCP393	BENDIX			
1.4 i	55, 57	04/91 → 02/98	FCP845	LUCAS/TRW			
1.4 i	55, 57	04/96 → 12/96	FCP393	BENDIX			

For material availability see page 16-18 / Per la disponibilità materiali vedere a pagina 16-18



KW



...RENAULT

...Clio

					NOTE			NOTE
1.7	66	06/90 → 12/96	FCP845	LUCAS/TRW				
1.7	66	06/90 → 12/96				FCP558	BENDIX	ABS
1.7 i	66	04/91 → 12/96	FCP845	LUCAS/TRW				
1.8 16V	99	01/91 → 04/96	FCP845	LUCAS/TRW				
1.8 16V	99	01/91 → 04/96				FCP558	BENDIX	
1.9 D	47	06/90 → 02/98	FCP393	BENDIX				
1.9 D	47	06/90 → 02/98	FCP845	LUCAS/TRW				
1.9 D	47	02/94 → 04/96	FCP845	LUCAS/TRW				
1.9 D	47	02/94 → 04/96	FCP393	BENDIX				
1.9 D	47	05/96 → 02/98	FCP845	LUCAS/TRW				
1.9 D	47	05/96 → 02/98	FCP393	BENDIX				
1.9 D Societe	47	02/94 → 02/98	FCP393	BENDIX				
1.9 D Societe	47	06/90 → 02/98	FCP393	BENDIX				
2.0 Williams 16V	108	11/93 → 04/96	FCP845	LUCAS/TRW				
2.0 Williams 16V	108	11/93 → 04/96				FCP558	BENDIX	

CLIO I (B/C57_, 5/357_)

1.8	66	08/90 → 04/96	FCP393	BENDIX				
1.8	66	08/90 → 04/96	FCP845	LUCAS/TRW				
1.8	66	08/90 → 04/96				FCP558	BENDIX	ABS
1.8 (B/C578)	66	08/94 → 09/98	FCP393	BENDIX				
1.8 (B/C578)	66	08/94 → 09/98	FCP845	LUCAS/TRW				
1.8 (B/C578)	66	08/94 → 09/98				FCP558	BENDIX	ABS
1.8 (B/C57C, B/C57U)	65	01/91 → 09/98	FCP393	BENDIX				
1.8 (B/C57C, B/C57U)	65	01/91 → 09/98	FCP845	LUCAS/TRW				
1.8 (B/C57C, B/C57U)	65	01/91 → 09/98				FCP558	BENDIX	ABS
1.8 Rsi (B/C579)	80	01/93 → 08/95	FCP393	BENDIX				
1.8 Rsi (B/C579)	80	01/93 → 08/95	FCP845	LUCAS/TRW				
1.8 Rsi (B/C579)	80	01/93 → 08/95				FCP558	BENDIX	ABS
1.8 Rsi (B/C57H)	79	08/95 → 09/98	FCP393	BENDIX				
1.8 Rsi (B/C57H)	79	08/95 → 09/98	FCP845	LUCAS/TRW				
1.8 Rsi (B/C57H)	79	08/95 → 09/98				FCP558	BENDIX	

Clio II

1.2	40, 44	03/98 →	FCP393	BENDIX				
1.2	40, 44	03/98 →	FCP845	LUCAS/TRW				
1.2 i 16V	55	04/00 →	FCP845	LUCAS/TRW				
1.4 i 16V	70	10/99 → 07/00	FCP845	LUCAS/TRW				
1.4 i 16V	70	10/99 → 07/00				FCP558	BENDIX	
1.4 i K4J DOHC 16V	55, 57	03/98 → 07/00	FCP845	LUCAS/TRW				
1.5 DCi	42	06/01 →	FCP845	LUCAS/TRW				
1.6 i K4M DOHC 16V	66	03/98 →	FCP845	LUCAS/TRW				
1.9 D	47	03/98 →	FCP393	BENDIX				
1.9 DTi	59	03/99 →	FCP845	LUCAS/TRW				
1.9 DTi	59	02/00 →	FCP845	LUCAS/TRW				
2.0 i RS	124	02/00 →	FCP406	LUCAS/TRW				
2.0 i RS	124	02/00 →				FCP558	BENDIX	
2.0 i RS	132	01/04 →	FCP406	LUCAS/TRW				
2.0 i RS	132	01/04 →				FCP558	BENDIX	
3.0 V6 Sport	166	11/00 → 12/02	FCP1348	BREMBO				
3.0 V6 Sport	166	11/00 → 12/02	FRP3083	AP RACING				
3.0 V6 Sport	166	11/00 → 12/02				FCP1348	BREMBO	
3.0 V6 Sport	187	12/02 → 12/04	FRP3083	AP RACING				
3.0 V6 Sport	187	12/02 → 12/04	FCP1348	BREMBO				
3.0 V6 Sport	187	12/02 → 12/04				FCP1348	BREMBO	
Super 1600		01/01 →	FRP216	AP RACING				
Super 1600		01/01 →				FCP342	AP RACING	

Clio III

1.2 i	48	05/06 →	FCP1617	LUCAS/TRW				
1.2 i	48	05/06 →				FCP1491	LUCAS/TRW	
1.2 i	55	05/06 →	FCP1617	LUCAS/TRW				
1.2 i	55	05/06 →				FCP1491	LUCAS/TRW	
1.2 i	58	05/06 →	FCP1617	LUCAS/TRW				
1.2 i	58	05/06 →				FCP1491	LUCAS/TRW	
1.4 i	72	05/06 →	FCP1617	LUCAS/TRW				
1.4 i	72	05/06 →				FCP1491	LUCAS/TRW	
1.5 Dci	50	05/06 →	FCP1617	LUCAS/TRW				
1.5 Dci	50	05/06 →				FCP1491	LUCAS/TRW	
1.5 Dci	60	05/06 →	FCP1617	LUCAS/TRW				
1.5 Dci	60	05/06 →				FCP1491	LUCAS/TRW	
1.5 Dci	63	05/06 →	FCP1617	LUCAS/TRW				
1.5 Dci	63	05/06 →				FCP1491	LUCAS/TRW	
1.5 Dci	76	05/06 →	FCP1617	LUCAS/TRW				
1.5 Dci	76	05/06 →				FCP1491	LUCAS/TRW	
1.5 Dci	78	05/06 →	FCP1617	LUCAS/TRW				
1.5 Dci	78	05/06 →				FCP1491	LUCAS/TRW	

For material availability see page 16-18 / Per la disponibilità materiali vedere a pagina 16-18



KW



...RENAULT

...Clio III

1.6 16V	65	06/05 → 10/07
1.6 16V	65	06/05 → 10/07
1.6 16V	82	06/05 →
1.6 16V	82	06/05 →
1.6 16V	94	11/07 →
1.6 16V	94	11/07 →
2.0 i RS	145	01/06 →
2.0 i RS	145	01/06 →
2.0 i RS	148	01/06 →
2.0 i RS	148	01/06 →

FCP1617	LUCAS/TRW
FCP1617	LUCAS/TRW
FCP1617	LUCAS/TRW
FCP1617	LUCAS/TRW
FCP1667	BREMBO
FCP1667	BREMBO

NOTE

FCP1491	LUCAS/TRW
FCP1491	LUCAS/TRW
FCP1491	LUCAS/TRW
FCP1491	LUCAS/TRW
FCP1491	LUCAS/TRW
FCP1491	LUCAS/TRW

NOTE

Clio IV

1.6 RS	147	03/13 →
1.6 RS	147	03/13 →

FCP4249	ATE	320mm disc
---------	-----	------------

FCP1491	LUCAS/TRW
---------	-----------

CLIO IV Grandtour

0.9 TCe 90	66	01/13 →
1.2 16V	54	01/13 →
1.2 TCe 120	88	03/13 →
1.5 dCi 75	55	01/13 →
1.5 dCi 90	66	01/13 →

FCP1617	LUCAS/TRW	Brake system 17"
FCP1617	LUCAS/TRW	Brake system 17"
FCP1617	LUCAS/TRW	Brake system 17"
FCP1617	LUCAS/TRW	Brake system 17"
FCP1617	LUCAS/TRW	Brake system 17"

Clio R3

R3	170	01/08 → 12/08
R3	170	01/08 → 12/08
R3	170	01/09 →
R3	170	01/09 →

FCP1667	BREMBO
FCP1667	BREMBO
FCP1667	BREMBO

FCP1491	LUCAS/TRW
FRP3056	AP RACING

Espace I

2.0 J/S112	78	01/84 → 01/91
2.0 J/S112	78	01/84 → 01/91
2.0 J/S112	78	01/84 → 01/91
2.0 J116	87	01/87 → 01/91
2.0 J116	87	01/87 → 01/91
2.0 J116	87	01/87 → 01/91
2.0 Quadra	87	01/87 → 01/91
2.0 Quadra	87	01/87 → 01/91
2.1 TD	65	01/84 → 12/90
2.1 TD	65	01/84 → 12/90
2.2 J117		01/87 → 01/91
2.2 J117		01/87 → 01/91
2.2 Quadra	81	01/88 → 12/90
2.2 Quadra	81	01/88 → 12/90

FCP845	LUCAS/TRW
FCP393	BENDIX
FCP845	LUCAS/TRW
FCP393	BENDIX
FCP845	LUCAS/TRW
FCP393	BENDIX
FCP845	LUCAS/TRW
FCP845	LUCAS/TRW
FCP845	LUCAS/TRW
FCP845	LUCAS/TRW
FCP845	LUCAS/TRW
FCP845	LUCAS/TRW
FCP845	LUCAS/TRW

FCP72	BENDIX	ABS
FCP72	BENDIX	ABS
FCP72	BENDIX	ABS
FCP72	BENDIX	ABS
FCP72	BENDIX	ABS
FCP72	BENDIX	ABS
FCP72	BENDIX	ABS
FCP72	BENDIX	ABS
FCP72	BENDIX	ABS
FCP72	BENDIX	ABS
FCP72	BENDIX	ABS
FCP72	BENDIX	ABS

Espace II

2.0	87	01/91 → 10/96
2.0	87	01/91 → 10/96
2.1 TD	65	01/91 → 05/92
2.1 TD	65	01/91 → 05/92
2.2	79	01/91 → 10/96
2.2	79	01/91 → 10/96
2.2 i	79	05/92 → 10/96
2.8 V6 (J638)	110	01/91 → 10/96
2.8 V6 (J638)	110	01/91 → 10/96
2.9 V6 24V		10/96 → 04/99
2.9 V6 24V		10/96 → 04/99
2.9 V6 24V	140	01/91 → 09/96
2.9 V6 24V	140	01/91 → 09/96

FCP393	BENDIX
FCP406	LUCAS/TRW
FCP406	LUCAS/TRW
FCP406	LUCAS/TRW
FCP406	LUCAS/TRW
FCP406	LUCAS/TRW
FCP406	LUCAS/TRW
FCP406	LUCAS/TRW
FCP406	LUCAS/TRW
FCP406	LUCAS/TRW

FCP72	BENDIX	ABS
FCP72	BENDIX	ABS
FCP72	BENDIX	ABS
FCP72	BENDIX	ABS
FCP72	BENDIX	ABS
FCP72	BENDIX	ABS
FCP72	BENDIX	ABS
FCP72	BENDIX	ABS
FCP72	BENDIX	ABS
FCP72	BENDIX	ABS

Espace III

2.0 i	84	11/96 → 10/02
2.0 i 16V	103	10/98 → 10/02

FCP878	BREMBO
FCP878	BREMBO

FCP878	BREMBO
FCP878	BREMBO

Espace III (JE0_)

2.2 DCi		10/00 → 10/02
3.0i V6 24V		07/00 → 10/02

FCP1491	LUCAS/TRW
FCP1491	LUCAS/TRW

FCP1491	LUCAS/TRW
FCP1491	LUCAS/TRW

Espace IV

1.9 dCi	88	11/02 →
2.0 i	127	11/02 →
2.0 i Turbo	120	11/02 →
2.2 dCi	110	11/02 →
3.0 i V6 24v	133	11/02 →
3.5 i V6	177	11/02 →

FCP1540	ATE
FCP1540	ATE
FCP1540	ATE
FCP1540	ATE
FCP1540	ATE
FCP1540	ATE

FCP1540	ATE
FCP1540	ATE
FCP1540	ATE
FCP1540	ATE
FCP1540	ATE
FCP1540	ATE

For material availability see page 16-18 / Per la disponibilità materiali vedere a pagina 16-18

RENAULT



KW



...RENAULT

NOTE

NOTE

Express

1.0 F400	31	10/85 → 12/92	FCP393	BENDIX
1.0 F400	31	10/85 → 12/92	FCP881	BENDIX
1.0 F400	31	10/85 → 12/92	FCP845	LUCAS/TRW
1.1 F401	34	10/85 → 12/92	FCP393	BENDIX
1.1 F401	34	10/85 → 12/92	FCP881	BENDIX
1.1 F401	34	10/85 → 12/92	FCP845	LUCAS/TRW
1.1 i F401	34	01/88 → 12/92	FCP393	BENDIX
1.1 i F401	34	01/88 → 12/92	FCP845	LUCAS/TRW
1.2		01/91 →	FCP393	BENDIX
1.2		01/91 →	FCP845	LUCAS/TRW
1.2 i		01/95 →	FCP393	BENDIX
1.2 i		01/95 →	FCP845	LUCAS/TRW
1.4 i		01/90 →	FCP393	BENDIX
1.4 i		01/90 →	FCP845	LUCAS/TRW
1.4 Not inj	43, 44	03/86 → 12/94	FCP393	BENDIX
1.4 Not inj	43, 44	03/86 → 12/94	FCP881	BENDIX
1.4 Not inj	43, 44	03/86 → 12/94	FCP845	LUCAS/TRW
1.6 D F404	40	07/86 → 07/88	FCP393	BENDIX
1.6 D (F404)	40	10/85 → 07/88	FCP881	BENDIX
1.6 D (F404)	40	10/85 → 12/92	FCP393	BENDIX
1.6 D (F404)	40	07/88 → 12/92	FCP845	LUCAS/TRW
1.9 D	40, 47	01/90 →	FCP393	BENDIX
1.9 D	40, 47	01/90 →	FCP881	BENDIX
1.9 D	40, 47	01/90 →	FCP845	LUCAS/TRW

Extra

1.0		10/85 → 12/92	FCP393	BENDIX
1.0		10/85 → 12/92	FCP881	BENDIX
1.0		10/85 → 12/92	FCP845	LUCAS/TRW
1.1	34	10/85 → 12/94	FCP393	BENDIX
1.1	34	10/85 → 12/94	FCP881	BENDIX
1.1	34	10/85 → 12/94	FCP845	LUCAS/TRW
1.4	43	03/86 → 12/94	FCP393	BENDIX
1.4	43	03/86 → 12/94	FCP845	LUCAS/TRW
1.4 i	44	01/90 → 08/97	FCP393	BENDIX
1.4 i	44	01/90 → 08/97	FCP845	LUCAS/TRW
1.4 i	44	01/90 → 08/97	FCP881	BENDIX
1.4 i	54	01/90 → 08/97	FCP393	BENDIX
1.4 i	54	01/90 → 08/97	FCP845	LUCAS/TRW
1.4 i	54	01/90 → 08/97	FCP881	BENDIX
1.4 i	58	01/90 → 08/97	FCP393	BENDIX
1.4 i	58	01/90 → 08/97	FCP845	LUCAS/TRW
1.4 i	58	01/90 → 08/97	FCP881	BENDIX
1.4 i	59	01/90 → 08/97	FCP393	BENDIX
1.4 i	59	01/90 → 08/97	FCP845	LUCAS/TRW
1.4 i	59	01/90 → 08/97	FCP881	BENDIX
1.6 D	40	10/85 → 12/92	FCP393	BENDIX
1.6 D	40	10/85 → 12/92	FCP881	BENDIX
1.6 D	40	10/85 → 12/92	FCP845	LUCAS/TRW
1.9 D	47	01/90 → 11/98	FCP393	BENDIX
1.9 D	47	01/90 → 11/98	FCP881	BENDIX
1.9 D	47	01/90 → 11/98	FCP845	LUCAS/TRW

Fuego

1.4	46	03/80 → 12/86	FCP393	BENDIX
1.4	46	03/80 → 12/86	FCP845	LUCAS/TRW
1.4	46	07/83 → 12/86	FCP393	BENDIX
1.4	46	07/83 → 12/86	FCP845	LUCAS/TRW
1.6	70, 92	03/80 → 07/83	FCP393	BENDIX
1.6	70, 92	03/80 → 07/83	FCP845	LUCAS/TRW
1.6 (Turbo)	92	07/83 → 12/86	FCP845	LUCAS/TRW
1.6 (Turbo)	92	07/83 → 12/86		FCP72 BENDIX
1.6 TL-GTL (R1361)	52	07/83 → 12/86	FCP393	BENDIX
1.6 TL-GTL (R1361)	52	07/83 → 12/86	FCP845	LUCAS/TRW
1.6 TS-GTS (R1362)	70	07/83 → 12/86	FCP393	BENDIX
2.0	74	07/80 → 12/86	FCP393	BENDIX
2.0	74	07/80 → 07/83	FCP845	LUCAS/TRW
2.0	74	07/83 → 12/86	FCP393	BENDIX
2.1 D R1362 TS GTS	65	01/83 → 12/86	FCP393	BENDIX
2.1 D TS-GTS (R1362)	65	01/80 → 12/86	FCP393	BENDIX
2.1 TD (R1366)	65	07/83 → 12/86	FCP845	LUCAS/TRW
2.2 Turbo (R1365)	74	01/84 → 12/86	FCP845	LUCAS/TRW
2.2 Turbo (R1365)	74	01/84 → 12/86		FCP72 BENDIX

For material availability see page 16-18 / Per la disponibilità materiali vedere a pagina 16-18

1182

FERODO

RACING

Updated on 17th Aug 2018

RENAULT



KW



...RENAULT

Laguna

					NOTE			NOTE
1.6 16V	07/98 → 12/00	FCP406	LUCAS/TRW	ABS				
1.8	02/97 → 06/98	FCP406	LUCAS/TRW					
1.8	66, 69 01/94 → 01/97	FCP406	LUCAS/TRW	ABS				
1.8	66, 69 01/94 → 01/97					FCP878	BREMBO	ABS
1.8 i	66, 69 10/94 → 01/97	FCP406	LUCAS/TRW					
1.8 i	66, 69 10/94 → 01/97					FCP878	BREMBO	
1.8 Nevada	66, 69 11/95 → 06/98	FCP406	LUCAS/TRW					
1.9 16V	103 06/95 → 06/98	FCP406	LUCAS/TRW	ABS				
1.9 16V	103 06/95 → 06/98					FCP878	BREMBO	ABS
1.9 DCi	79 09/99 → 02/01	FCP565	LUCAS/TRW					
1.9 DTi	72 01/99 → 02/01	FCP406	LUCAS/TRW					
2.0	83 01/94 → 01/97	FCP406	LUCAS/TRW	ABS				
2.0	83 01/94 → 01/97					FCP878	BREMBO	ABS
2.0	83 02/97 → 03/01	FCP406	LUCAS/TRW					
2.0 (B/K56M) 16V	103 01/95 → 06/98	FCP406	LUCAS/TRW					
2.0 Baccara (B56H)	83 01/94 → 03/01	FCP406	LUCAS/TRW					
2.0 i	83 07/94 → 01/97	FCP406	LUCAS/TRW					
2.0 i	83 07/94 → 01/97					FCP878	BREMBO	
2.0 Nevada	83 11/95 → 06/98	FCP406	LUCAS/TRW					
2.2 D	61 01/94 → 01/97	FCP406	LUCAS/TRW					
2.2 D	61 01/94 → 01/97					FCP878	BREMBO	ABS
2.2 D	61 02/97 → 06/98	FCP406	LUCAS/TRW					
2.2 D Nevada	61 11/95 → 06/98	FCP406	LUCAS/TRW					
2.2 D Nevada	61 11/95 → 06/98					FCP878	BREMBO	
2.2 TD 12V	83 07/98 → 02/01	FCP406	LUCAS/TRW					
2.2 TD 12V	83 01/94 → 01/97	FCP406	LUCAS/TRW					
2.2 TD 12V	83 01/94 → 01/97					FCP878	BREMBO	ABS
2.2 TD 12V	83 02/97 → 02/01	FCP406	LUCAS/TRW					
2.9 V6 24V	140 04/97 → 02/01	FCP406	LUCAS/TRW					
2.9 V6 24V	140 04/97 → 02/01					FCP878	BREMBO	
3.0 V6 24V	123, 140 01/94 → 01/97	FCP406	LUCAS/TRW					
3.0 V6 24V	123, 140 01/94 → 01/97					FCP878	BREMBO	ABS
3.0 V6 24V	123, 140 02/97 → 06/98	FCP406	LUCAS/TRW					
3.0 V6, Nevada 24V	123, 140 02/97 → 06/98	FCP406	LUCAS/TRW					

Laguna Coupe (DT0/1)

2.0 16V Turbo	125 09/08 →	FCP4249	ATE					
2.0 dCi	127 09/08 →	FCP4249	ATE					
2.0 dCi (DT01, DT09, DT12, DT1D)	110 09/08 →	FCP4249	ATE					
2.0 dCi GT (DT11, DT1E, DT1N)	131 03/08 →	FCP4249	ATE					
2.0 GT	150 09/08 →	FCP4249	ATE					

Laguna II

1.6 i 16V	76 03/01 →					FCP1540	ATE	
1.6 i Berline 16V	79 03/01 →					FCP1540	ATE	
1.6 i Grandtour 16V	76 03/01 →					FCP1540	ATE	
1.8 i 16V	86 03/01 →					FCP1540	ATE	
1.8 i Berline/Grandtour 16V	86 03/01 →					FCP1540	ATE	
1.9 dCi	88 03/01 →					FCP1540	ATE	
1.9 dCi Berline/Grandtour	88 03/01 →					FCP1540	ATE	
2.0 i Berline/Grandtour 16V	103 03/01 →					FCP1540	ATE	
2.2 dCi Berline/Grandtour	110 03/01 →					FCP1540	ATE	
3.0 i Berline/Grandtour 24v	152 03/01 →					FCP1540	ATE	

Laguna III

2.0 dCi (BT08, BT0K, BT0J, BT14, BT1A, BT1D)	96 10/07 →	FCP4249	ATE					
2.0 Hi-Flex (BT1H)	103 06/09 →	FCP4249	ATE					
2.0 Hi-Flex Estate/Break (KT1H)	103 06/09 →	FCP4249	ATE					
3.0 dCi (BT03)	173 09/08 →	FCP4249	ATE					
3.0 dCi Coupe' (DT0L)	177 01/12 →	FCP4249	ATE					
3.0 dCi Coupe' (DT0L)	177 01/12 →					FCP1931	ATE	
3.0 dCi Estate/Break (KT03)	173 01/08 →	FCP4249	ATE					
3.5 (BT0C/BTOP)	175 09/08 →	FCP4249	ATE					
3.5 Coupe' (DT0C/DT0P)	175 09/08 →	FCP4249	ATE					
3.5 Estate/Break (KT0C/KTOP)	175 04/08 →	FCP4249	ATE					

Laguna III (BT0/1)

2.0 16V (BT05, BT0F, BT0W)	103 10/07 →	FCP4249	ATE					
2.0 16V Turbo	125 10/07 →	FCP4249	ATE					
2.0 dCi (BT01, BT09, BT12, BT1S)	110 10/07 →	FCP4249	ATE					
2.0 dCi (BT0M, BT0N, BT19)	127 01/08 →	FCP4249	ATE					
2.0 dCi GT (BT1E, BT1N)	131 03/08 →	FCP4249	ATE					
2.0 GT	150 03/08 →	FCP4249	ATE					

For material availability see page 16-18 / Per la disponibilità materiali vedere a pagina 16-18



KW



...RENAULT

Laguna III Grandtour (KT0/1)

2.0 16V (KT0F, KT0W)	103	10/07 →
2.0 16V Turbo	125	10/07 →
2.0 dCi (KT01, KT09, KT12, KT1S)	110	10/07 →
2.0 dCi (KT0M, KT0N, KT19)	127	01/08 →
2.0 dCi GT (KT11, KT1E, KT1N)	131	03/08 →
2.0 GT	150	03/08 →

Latitude

3.0 dCi (L70G)	177	02/11 →
----------------	-----	---------

Logan

1.4 8v (KS0A)	55	10/07 →
1.4 8v (LS0A/LS0C/LS0E)	55	08/04 →
1.6 8v (LS0B/LS0D)	64	08/05 →

Master

2.0	58	01/79 → 09/94
2.0	59	01/79 → 09/94
2.0	60	01/79 → 10/97
2.1	46	01/79 → 10/97
2.2	71	01/79 → 10/97
2.4 D	50	01/79 → 10/97
2.4 D	52	01/79 → 10/97
2.4 D	53	01/79 → 10/97
2.5 D	59	01/79 → 10/97
2.5 D	69	01/79 → 10/97
2.5 D	70	01/79 → 10/97

Megane

1.4 i		03/99 → 08/02
1.4 i	52, 55	10/95 → 02/99
1.6 Break		03/99 → 08/02
1.6 Cabrio 16V		03/99 → 08/02
1.6 i	55, 66	10/95 → 02/99
1.6 i Coupe	55, 66	02/96 → 02/99
1.6i Cabrio 16V		03/99 → 08/02
1.6i Classic		03/99 → 08/02
1.6i Coupe		02/96 → 02/99
1.6i Coupe		02/96 → 02/99
1.6i Coupe		03/99 → 08/02
1.6i SW Estate		03/99 → 08/02
1.6i SW Estate		03/99 → 08/02
1.6i SW Estate		03/99 → 08/02
1.8 i 16V	85	01/01 → 08/02
1.9 D	47, 66	10/95 → 08/02
1.9 DTi Break	66	03/99 → 08/02
1.9 DTi Classic	66	03/99 → 08/02
1.9 DTi Classic		03/99 → 08/02
1.9 DTi Classic		03/99 → 08/02
1.9 DTi Coupe	66	03/99 → 08/02
1.9 DTi Coupe		03/99 → 08/02
1.9 DTi Coupe		03/99 → 08/02
1.9 DTi SW Estate		03/99 → 08/02
1.9 DTi SW Estate		03/99 → 08/02
1.9 TD	47, 66	10/95 → 02/99
2.0 Coupe, Coach	103	03/99 → 08/02
2.0 i	84	10/95 → 08/02
2.0 i 16V	108	10/95 → 08/02
2.0 i 16V	108	10/95 → 08/02
2.0 i Coach 16V	108	02/96 → 02/99
2.0 i Coupe	83	02/96 → 02/99
2.0 i Coupe 16V	108	02/96 → 02/99
2.0i Coupe		02/96 → 02/99
2.0i Coupe		02/96 → 02/99
2.0i Coupe 16V		02/96 → 02/99
2.0i Coupe 16V		02/96 → 02/99
2.0i Coupe, Coach		03/99 → 08/02
2.0i Coupe, Coach		03/99 → 08/02

Megane II

1.4i 16V	72	09/02 →
1.5 DCi	60	09/02 →
1.6i 16V	83	09/02 →
1.9 DCi	88	09/02 →
2.0 20i Sport 16V Turbo	120	03/04 →

			NOTE		NOTE
FCP4249	ATE				
FCP4249	ATE				
FCP4249	ATE				
FCP4249	ATE				
FCP4249	ATE				
FCP4249	ATE				
FCP4249	ATE				
FCP4249	ATE				
FCP845	LUCAS/TRW				
FCP845	LUCAS/TRW				
FCP845	LUCAS/TRW				
FCP817	LUCAS/TRW				
FCP817	LUCAS/TRW				
FCP817	LUCAS/TRW				
FCP817	LUCAS/TRW				
FCP817	LUCAS/TRW				
FCP817	LUCAS/TRW				
FCP817	LUCAS/TRW				
FCP817	LUCAS/TRW				
FCP817	LUCAS/TRW				
FCP817	LUCAS/TRW				
FCP817	LUCAS/TRW				
FCP845	LUCAS/TRW				
FCP845	LUCAS/TRW				
FCP845	LUCAS/TRW				
FCP565	LUCAS/TRW				
FCP845	LUCAS/TRW				
FCP845	LUCAS/TRW				
FCP406	LUCAS/TRW				
FCP1491	LUCAS/TRW				
FCP1491	LUCAS/TRW				
FCP845	LUCAS/TRW				
FCP1491	LUCAS/TRW				
FCP1491	LUCAS/TRW				
FCP845	LUCAS/TRW				
FCP406	LUCAS/TRW				
FCP1491	LUCAS/TRW				
FCP558	BENDIX				
FCP845	LUCAS/TRW				
FCP565	LUCAS/TRW				
FCP565	LUCAS/TRW				
FCP406	LUCAS/TRW				
FCP1491	LUCAS/TRW				
FCP565	LUCAS/TRW				
FCP406	LUCAS/TRW				
FCP406	LUCAS/TRW				
FCP1491	LUCAS/TRW				
FCP1491	LUCAS/TRW				
FCP845	LUCAS/TRW				
FCP565	LUCAS/TRW				
FCP406	LUCAS/TRW				
FCP845	LUCAS/TRW				
FCP406	LUCAS/TRW				
FCP406	LUCAS/TRW				
FCP1491	LUCAS/TRW				
FCP1491	LUCAS/TRW				
FCP406	LUCAS/TRW				
FCP1491	LUCAS/TRW				
FCP1491	LUCAS/TRW				
FCP1491	LUCAS/TRW				
FCP1667	BREMBO				

For material availability see page 16-18 / Per la disponibilità materiali vedere a pagina 16-18



KW



...RENAULT

...Megane II

2.0i 16V 99 09/02 →

FCP1491 LUCAS/TRW

Megane III Coupe (DZ0/1_)

2.0 R.S. 195 11/08 →

FCP1334 BREMBO

340mm discs

2.0 R.S. 195 11/08 →

FCP1667 BREMBO

2.0 R.S. 195 11/08 →

FCP1491 LUCAS/TRW without el.handbrake, 300mm discs

2.0 R.S. 201 07/14 →

FCP1334 BREMBO

2.0 R.S. 201 07/14 →

FCP1491 LUCAS/TRW without el.handbrake, 300mm discs

Megane Scenic

1.4 i 55 01/96 → 05/99

FCP845 LUCAS/TRW

1.4 i 55 10/98 → 05/99

FCP845 LUCAS/TRW

1.4 i 16V 70 06/99 →

FCP565 LUCAS/TRW

1.4 i 16V 70 06/99 →

FCP541 LUCAS/TRW

1.6 i 55,66 01/96 → 05/99

FCP845 LUCAS/TRW

1.6 i 55,66 10/98 → 05/99

FCP845 LUCAS/TRW

1.6 i 16V 80 06/99 →

FCP565 LUCAS/TRW

1.6 i 16V 80 06/99 →

FCP541 LUCAS/TRW

1.9 D 47 01/96 → 05/99

FCP406 LUCAS/TRW

1.9 D 47 10/98 → 05/99

FCP406 LUCAS/TRW

1.9 DCi 72 06/99 →

FCP565 LUCAS/TRW

1.9 DCi 72 06/99 →

FCP541 LUCAS/TRW

1.9 TD 66 01/96 →

FCP406 LUCAS/TRW

1.9 TD 66 10/98 → 05/99

FCP406 LUCAS/TRW

2.0 i 84 01/96 → 05/99

FCP406 LUCAS/TRW

2.0 i 16V 103 06/99 →

FCP565 LUCAS/TRW

2.0 i 16V 103 06/99 →

FCP541 LUCAS/TRW

Modus

1.2 i 16V 55 12/04 →

FCP1617 LUCAS/TRW

1.4 i 16V 72 12/04 →

FCP1617 LUCAS/TRW

1.5 DCi 50 12/04 →

FCP1617 LUCAS/TRW

1.5 DCi 63 12/04 →

FCP1617 LUCAS/TRW

1.6 i 16V 82 12/04 →

FCP1617 LUCAS/TRW

R5

1.4 Alpine Turbo 68 01/76 → 12/84

FCP360 BENDIX

1.4 Alpine Turbo 68 01/81 → 12/84

FCP72 BENDIX

Rapid

0.9 F400 01/85 → 12/90

FCP881 BENDIX

1.1 F401 33 07/85 → 12/88

FCP845 LUCAS/TRW

1.1 F401 33 07/85 → 09/91

FCP881 BENDIX

1.2 40 09/91 →

FCP393 BENDIX

1.2 40 09/91 →

FCP845 LUCAS/TRW

1.4 01/97 →

FCP393 BENDIX

1.4 01/97 →

FCP845 LUCAS/TRW

1.4 43,44 07/85 → 06/87

FCP393 BENDIX

1.4 43,44 07/85 → 06/87

FCP845 LUCAS/TRW

1.6 D 40 03/86 → 08/91

FCP881 BENDIX

1.6 D 40 03/86 → 08/91

FCP845 LUCAS/TRW

1.9 D F40 40,47 01/97 → 07/98

FCP845 LUCAS/TRW

1.9 D F40 40,47 01/97 → 07/98

FCP393 BENDIX

1.9 D F40 40,47 09/91 → 07/98

FCP393 BENDIX

1.9 D F40 40,47 09/91 → 07/98

FCP845 LUCAS/TRW

RAPID Box (F40_, G40_)

1.4 (F402) 43 07/85 → 08/91

FCP393 BENDIX

1.4 (F402) 43 07/85 → 08/91

FCP845 LUCAS/TRW

1.4 (F40D) 58 01/94 → 03/98

FCP393 BENDIX

1.4 (F40D) 58 01/94 → 03/98

FCP845 LUCAS/TRW

1.4 (F40M) 44 03/86 → 08/91

FCP393 BENDIX

1.4 (F40M) 44 03/86 → 08/91

FCP845 LUCAS/TRW

1.4 (F40U, F40V) 55 09/91 → 03/98

FCP393 BENDIX

1.4 (F40U, F40V) 55 09/91 → 03/98

FCP845 LUCAS/TRW

1.4 Cat (F407) 43 08/88 → 03/98

FCP393 BENDIX

1.4 Cat (F407) 43 08/88 → 03/98

FCP845 LUCAS/TRW

1.4 RN 44 09/91 → 08/93

FCP393 BENDIX

1.4 RN 44 09/91 → 08/93

FCP845 LUCAS/TRW

Safrane

1.9 16V 100 04/92 → 01/97

FCP406 LUCAS/TRW

1.9 16V 100 04/92 → 01/97

FCP878 BREMBO ABS

1.9 16V 100 02/97 → 12/00

FCP406 LUCAS/TRW

2.0 i 77,97 04/92 → 09/96

FCP406 LUCAS/TRW

2.0 i 77,97 04/92 → 09/96

FCP878 BREMBO ABS

For material availability see page 16-18 / Per la disponibilità materiali vedere a pagina 16-18

RENAULT



KW



...RENAULT

...Safrane

					NOTE			NOTE
2.0 i (B54E)		01/92 → 09/96	FCP406	LUCAS/TRW				
2.0 i (B54E)		01/92 → 09/96				FCP878	BREMBO	
2.0 i 16V	101	10/96 → 12/00	FCP406	LUCAS/TRW				
2.0 i 16V	101	10/96 → 12/00				FCP878	BREMBO	
2.1 TD	65	10/96 → 12/00	FCP406	LUCAS/TRW				
2.1 TD (B546)	65	04/92 → 09/96	FCP406	LUCAS/TRW				
2.1 TD (B546)	65	04/92 → 09/96				FCP878	BREMBO	ABS
2.2 (B541)	79, 83	04/92 → 09/96	FCP406	LUCAS/TRW				
2.2 (B541)	79, 83	04/92 → 09/96				FCP878	BREMBO	ABS
2.2 (B543)	101	04/92 → 09/96	FCP406	LUCAS/TRW				
2.2 (B543)	101	04/92 → 09/96				FCP878	BREMBO	ABS
2.2 i B543	101	02/95 → 09/96	FCP406	LUCAS/TRW				
2.2 i B543	101	02/95 → 09/96				FCP878	BREMBO	
2.2 TD (B54G)	84	10/96 → 12/00	FCP406	LUCAS/TRW				
2.2 TD (B54G)	84	10/96 → 12/00				FCP878	BREMBO	ABS
2.4		04/92 → 01/97	FCP406	LUCAS/TRW				
2.4		04/92 → 01/97				FCP878	BREMBO	ABS
2.4		02/97 → 12/00	FCP406	LUCAS/TRW				
2.5 20V	123	10/96 → 12/00	FCP406	LUCAS/TRW				
2.5 20V	123	10/96 → 12/00				FCP878	BREMBO	ABS
2.5 TD (B548)	83	04/92 → 09/96	FCP406	LUCAS/TRW				
2.5 TD (B548)	83	04/92 → 09/96				FCP878	BREMBO	ABS
3.0 B54B		04/92 → 09/96	FCP406	LUCAS/TRW				
3.0 B54B		04/92 → 09/96				FCP878	BREMBO	
3.0 V6 (B54M)	124	10/96 → 12/00	FCP406	LUCAS/TRW				
3.0 V6 (B54M)	124	10/96 → 12/00				FCP878	BREMBO	ABS
3.0 V6 Quadra (B544)	123	04/92 → 09/96	FCP406	LUCAS/TRW				
3.0 V6 Quadra (B544)	123	04/92 → 09/96				FCP878	BREMBO	ABS

Scenic

1.4i 16V		06/99 → 05/03	FCP406	LUCAS/TRW				
1.4i 16V		06/99 → 05/03				FCP1491	LUCAS/TRW	
1.6i 16V		06/99 → 05/03	FCP406	LUCAS/TRW				
1.6i 16V		06/99 → 05/03				FCP1491	LUCAS/TRW	
1.9 DCi	75	11/00 → 05/03	FCP406	LUCAS/TRW				
1.9 DCi	75	11/00 → 05/03				FCP1491	LUCAS/TRW	
1.9 DCi RX4	75	11/00 → 05/03	FCP406	LUCAS/TRW				
1.9 DCi RX4	75	11/00 → 05/03				FCP1491	LUCAS/TRW	
1.9 DTi		06/99 → 05/03	FCP406	LUCAS/TRW				
1.9 DTi		06/99 → 05/03				FCP1491	LUCAS/TRW	
2.0i 16V		06/99 → 05/03	FCP406	LUCAS/TRW				
2.0i 16V		06/99 → 05/03				FCP1491	LUCAS/TRW	
2.0i RX4 16V	102	06/00 → 05/03	FCP406	LUCAS/TRW				
2.0i RX4 16V	102	06/00 → 05/03				FCP1491	LUCAS/TRW	

Scenic II (JM0/1_)

1.4i 16V	72	06/03 →				FCP1491	LUCAS/TRW	
1.5 DCi 16V	74	06/03 →				FCP1491	LUCAS/TRW	
1.6i 16V	83	06/03 →				FCP1491	LUCAS/TRW	
1.9DCi 16V	88	06/03 →				FCP1491	LUCAS/TRW	
2.0i 16V	99	06/03 →				FCP1491	LUCAS/TRW	

Spider

2.0 16V	108	01/96 →	FCP406	LUCAS/TRW				
2.0 16V	108	01/96 →	FCP565	LUCAS/TRW				

SUPER 5 (B/C40_)

1.4 (B/C402)	43	10/84 → 06/88	FCP393	BENDIX				
1.4 (B/C402)	43	10/84 → 06/88	FCP845	LUCAS/TRW				
1.4 (B/C402)	43	10/84 → 06/88	FCP881	BENDIX				
1.4 (B/C403)	52	10/84 → 07/89	FCP393	BENDIX				
1.4 (B/C403)	52	10/84 → 07/89	FCP845	LUCAS/TRW				
1.4 (B/C403)	52	10/84 → 07/89	FCP881	BENDIX				
1.4 (B/C40J)	49	06/87 → 07/89	FCP393	BENDIX				
1.4 (B/C40J)	49	06/87 → 07/89	FCP845	LUCAS/TRW				
1.4 (B/C40J)	49	06/87 → 07/89	FCP881	BENDIX				
1.4 (B/C40M)	44	06/87 → 08/90	FCP393	BENDIX				
1.4 (B/C40M)	44	06/87 → 08/90	FCP845	LUCAS/TRW				
1.4 (B/C40M)	44	06/87 → 08/90	FCP881	BENDIX				
1.4 Cat (B/C407)	43	10/85 → 12/96	FCP393	BENDIX				
1.4 Cat (B/C407)	43	10/85 → 12/96	FCP845	LUCAS/TRW				
1.4 Cat (B/C407)	43	10/85 → 12/96	FCP881	BENDIX				
1.4 Turbo (C405)	88	04/85 → 08/90	FCP845	LUCAS/TRW				
1.4 Turbo (C405)	88	04/85 → 08/90				FCP558	BENDIX	
1.4 Turbo GT (C405)	118	01/85 → 05/91	FCP845	LUCAS/TRW				
1.4 Turbo GT (C405)	118	01/85 → 05/91				FCP558	BENDIX	

For material availability see page 16-18 / Per la disponibilità materiali vedere a pagina 16-18



KW

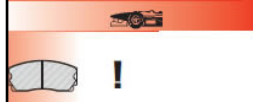

...RENAULT

Twingo

1.1	40, 44	05/96 → 12/98	FCP881	BENDIX
1.1	40, 44	01/98 →	FCP845	LUCAS/TRW
1.2	40	03/93 → 05/96	FCP881	BENDIX
1.2 i	44	09/00 →	FCP845	LUCAS/TRW
1.2 i 16V	55	01/01 →	FCP845	LUCAS/TRW
1.6 16V 133Cv		01/10 →	FCP1441	ATE
1.6 16V 133Cv		01/10 →		FCP1491 LUCAS/TRW
R2		01/10 → 12/10	FCP1441	ATE
R2		01/10 → 12/10		FCP1491 LUCAS/TRW
R2		01/11 →	FRP3119	
R2		01/11 →		FCP1491 LUCAS/TRW

Twingo II

1.2 8v (CN0D/GN0D)	43	03/07 →	FCP845	LUCAS/TRW
1.5 dCi 8v (CN0E/GN0E)	47	03/07 →	FCP845	LUCAS/TRW

Vel Satis

2.0 i 16V	120	04/02 →		FCP1540 ATE
2.2 dCi	85	04/02 →		FCP1540 ATE
3.0 dCi V6	130	04/02 →		FCP1540 ATE
3.5 i V6	177	04/02 →		FCP1540 ATE

RENAULT-ALPINE

1300

1.3		03/73 → 06/76	FCP72	BENDIX
1.3		03/73 → 06/76		FCP72 BENDIX

1600

1.6		03/73 → 06/76	FCP72	BENDIX
1.6		03/73 → 06/76		FCP72 BENDIX

2500

2.5		02/85 →	FCP845	LUCAS/TRW
2.5		02/85 →		FCP393 BENDIX

2700

2.7		10/76 → 12/80	FCP72	BENDIX
2.7		10/76 → 12/80		FCP72 BENDIX

2800

2.8		02/85 → 02/90	FCP845	LUCAS/TRW
2.8		02/85 → 02/90		FCP393 BENDIX

3000

3.0		06/91 →	FCP406	LUCAS/TRW
3.0		06/91 →		FCP72 BENDIX

A110

1300		01/73 → 12/76		FCP360 BENDIX
1600		01/73 → 12/76		FCP360 BENDIX

A310 (GTA)

1.4		01/71 → 08/83	FCP72	BENDIX
1.4		01/71 → 08/83		FCP72 BENDIX

A610 (GTA)

3.0 (Turbo)		01/91 →	FCP406	LUCAS/TRW
3.0 (Turbo)		01/91 →	FCP565	LUCAS/TRW

Alpine (GTA)

GT/V6 Turbo		09/85 → 12/90	FCP845	LUCAS/TRW
GT/V6 Turbo		09/85 → 12/90		FCP393 BENDIX

ROVER

For material availability see page 16-18 / Per la disponibilità materiali vedere a pagina 16-18



KW



ROVER

1500

1.5 & TC Triumph 45, 55 01/70 → 12/74 **FCP810** LUCAS/TRW

1800

1.8 56 01/72 → 12/74 **FCP9** LUCAS/TRW

1885

All i Wolseley S 56 01/69 → 12/72 **FCP9** LUCAS/TRW

200 Convertible (XW)

216 1.6i 90 01/92 → 11/99 **FCP613** LUCAS/TRW Vented

216 1.6i 90 01/92 → 11/99 **FCP613** LUCAS/TRW Vented **FCP472** AKEBONO

216 1.6i 16V 82 01/96 → 11/99 **FCP613** LUCAS/TRW Vented

200 Coupe (XW)

216 82 01/96 → 12/97 **FCP613** LUCAS/TRW Vented

216 82 01/96 → 12/97 **FCP613** LUCAS/TRW Vented **FCP472** AKEBONO

216 90 10/92 → 06/99 **FCP613** LUCAS/TRW Vented

216 90 10/92 → 06/99 **FCP613** LUCAS/TRW Vented **FCP472** AKEBONO

220 GSi 100 05/94 → 06/99 **FCP613** LUCAS/TRW

220 GSi 100 05/94 → 06/99 **FCP613** LUCAS/TRW **FCP472** AKEBONO

220 Turbo 147 10/92 → 06/99 **FCP613** LUCAS/TRW

220 Turbo 147 10/92 → 06/99 **FCP613** LUCAS/TRW **FCP472** AKEBONO

200 Hatchback (RF)

216 Si 82 11/95 → 03/00 **FCP613** LUCAS/TRW Vented

216 Si 82 11/95 → 03/00 **FCP613** LUCAS/TRW Vented **FCP472** AKEBONO

200 Hatchback (XW)

216 GSi 82 10/89 → 10/95 **FCP613** LUCAS/TRW Vented

216 GSi 85 10/89 → 10/95 **FCP613** LUCAS/TRW Vented

216 GTi 90 09/90 → 10/95 **FCP613** LUCAS/TRW Vented

220 GTi 100 01/93 → 10/95 **FCP613** LUCAS/TRW

220 GTi 100 01/93 → 10/95 **FCP613** LUCAS/TRW **FCP472** AKEBONO

220 GTi 103 09/91 → 10/95 **FCP613** LUCAS/TRW

220 GTi 103 09/91 → 10/95 **FCP613** LUCAS/TRW **FCP472** AKEBONO

220 Turbo 147 01/93 → 10/95 **FCP613** LUCAS/TRW

220 Turbo 147 01/93 → 10/95 **FCP613** LUCAS/TRW **FCP472** AKEBONO

214

1.4 55 10/89 → 12/95 **FCP613** LUCAS/TRW Vented

1.4 55 10/89 → 12/95 **FCP613** LUCAS/TRW Vented **FCP472** AKEBONO

1.4 66 10/89 → 12/95 **FCP613** LUCAS/TRW Vented

1.4 66 10/89 → 12/95 **FCP613** LUCAS/TRW Vented **FCP472** AKEBONO

1.4 76 10/89 → 12/95 **FCP613** LUCAS/TRW Vented

1.4 76 10/89 → 12/95 **FCP613** LUCAS/TRW Vented **FCP472** AKEBONO

1.4 16V 55, 76 03/95 → 06/99 **FCP613** LUCAS/TRW

1.4 16V 55, 76 03/95 → 06/99 **FCP613** LUCAS/TRW **FCP472** AKEBONO

218

1.8 16V 107 03/95 → 06/99 **FCP613** LUCAS/TRW

1.8 16V 107 03/95 → 06/99 **FCP613** LUCAS/TRW **FCP472** AKEBONO

1.8 D 64, 65 03/91 → 12/95 **FCP613** LUCAS/TRW Vented

1.8 D 64, 65 03/91 → 12/95 **FCP613** LUCAS/TRW Vented **FCP472** AKEBONO

1.8 i Coupe 16V 01/92 → 06/99 **FCP613** LUCAS/TRW

1.8 i Vi 16V 01/96 → 06/99 **FCP613** LUCAS/TRW

1.9 D 44, 47 03/91 → 12/95 **FCP613** LUCAS/TRW Vented

1.9 D 44, 47 03/91 → 12/95 **FCP613** LUCAS/TRW Vented **FCP472** AKEBONO

220

2.0 D 63, 77 11/95 → 06/99 **FCP613** LUCAS/TRW

2.0 D SDi 77 01/96 → 06/99 **FCP613** LUCAS/TRW

2200

2.2 01/72 → 12/74 **FCP9** LUCAS/TRW

25

1.1 60 09/99 → **FCP613** LUCAS/TRW

1.1 60 09/99 → **FCP613** LUCAS/TRW **FCP472** AKEBONO

1.4 16V 62, 76 07/99 → **FCP613** LUCAS/TRW

1.4 16V 62, 76 07/99 → **FCP613** LUCAS/TRW **FCP472** AKEBONO

1.6 16V 80 07/99 → **FCP613** LUCAS/TRW

1.6 16V 80 07/99 → **FCP613** LUCAS/TRW **FCP472** AKEBONO

1.8 16V 86, 107 07/99 → **FCP613** LUCAS/TRW

1.8 16V 86, 107 07/99 → **FCP613** LUCAS/TRW **FCP472** AKEBONO

2.0 D 74 07/99 → **FCP613** LUCAS/TRW

For material availability see page 16-18 / Per la disponibilità materiali vedere a pagina 16-18



KW



...ROVER

...25

2.0 D 74 07/99 →

400 (RT)

416 Si	82	05/95 → 03/00	FCP613	LUCAS/TRW	
416 Si	82	05/95 → 03/00			
416 Si	83	05/95 → 03/00	FCP613	LUCAS/TRW	
416 Si	83	05/95 → 03/00			
416 Si	85	05/95 → 03/00	FCP613	LUCAS/TRW	
416 Si	85	05/95 → 03/00			

400 (XW)

416 GSI	82	04/90 → 04/95	FCP613	LUCAS/TRW	Vented
416 GSI	82	04/90 → 04/95			
416 GSI/GSE	85	04/90 → 04/95	FCP613	LUCAS/TRW	Vented
416 GSI/GSE	85	04/90 → 04/95			
416 GTI	90	04/90 → 04/95	FCP613	LUCAS/TRW	Vented
416 GTI	90	04/90 → 04/95			
416 GTI/GTE	96	04/90 → 04/95	FCP613	LUCAS/TRW	Vented
416 GTI/GTE	96	04/90 → 04/95			

400 Hatchback (RT)

416 Si	82	05/95 → 03/00	FCP613	LUCAS/TRW	
416 Si	82	05/95 → 03/00			
416 Si	83	06/95 → 03/00	FCP613	LUCAS/TRW	
416 Si	83	06/95 → 03/00			
416 Si	85	06/95 → 03/00	FCP613	LUCAS/TRW	
416 Si	85	06/95 → 03/00			

414

1.4 16V	66, 76	03/95 → 06/99	FCP613	LUCAS/TRW	
1.4 16V	66, 76	03/95 → 06/99			
1.4 16V	66	03/90 → 12/95	FCP613	LUCAS/TRW	Vented
1.4 16V	66	03/90 → 12/95			
1.4 16V	70	03/90 → 12/95	FCP613	LUCAS/TRW	Vented
1.4 16V	70	03/90 → 12/95			
1.4 16V	76	03/90 → 12/95	FCP613	LUCAS/TRW	Vented
1.4 16V	76	03/90 → 12/95			

418

1.8 TD	65	03/90 → 12/95	FCP613	LUCAS/TRW	Vented
1.8 TD	65	03/90 → 12/95			
1.8 TD	65	03/95 → 06/99	FCP613	LUCAS/TRW	
1.8 TD	65	03/95 → 06/99			
1.9 D	47	03/90 → 12/95	FCP613	LUCAS/TRW	Vented
1.9 D	47	03/90 → 12/95			

420

2.0 i ,Tourer, Turbo 16V	103, 152	01/91 → 12/96	FCP613	LUCAS/TRW	
2.0 i ,Tourer, Turbo 16V	103, 152	01/91 → 12/96			
2.0 i 16V	103	05/95 → 06/99	FCP613	LUCAS/TRW	
2.0 i 16V	103	05/95 → 06/99			
2.0 i Sli,Gsi,Exec.,Sport 16V		01/91 → 12/95	FCP613	LUCAS/TRW	
2.0 i Sli,Gsi,Exec.,Sport 16V		01/91 → 12/95			
2.0 TD	63	05/95 → 06/99	FCP613	LUCAS/TRW	
2.0 TD	63	05/95 → 06/99			
2.0 TDi	77	05/95 → 06/99	FCP613	LUCAS/TRW	
2.0 TDi	77	05/95 → 06/99			

45

1.4 16V	76	09/99 →	FCP613	LUCAS/TRW	
1.4 16V	76	09/99 →			
1.6 16V	80	09/99 →	FCP613	LUCAS/TRW	
1.6 16V	80	09/99 →			
1.8 16V	86	09/99 →	FCP613	LUCAS/TRW	
1.8 16V	86	09/99 →			

618

1.8 16V	84	04/93 → 06/99	FCP904	AKEBONO	14" wheel
1.8 16V	84	04/93 → 06/99	FCP905	AKEBONO	15" wheel
1.8 16V	84	04/93 → 06/99			

FCP472 AKEBONO

FCP472 AKEBONO

FCP472 AKEBONO

FCP472 AKEBONO

FCP472 AKEBONO

FCP472 AKEBONO

FCP472 AKEBONO

FCP472 AKEBONO

FCP472 AKEBONO

FCP472 AKEBONO

FCP472 AKEBONO

FCP472 AKEBONO

FCP472 AKEBONO

FCP472 AKEBONO

FCP472 AKEBONO

FCP472 AKEBONO

FCP472 AKEBONO

FCP472 AKEBONO

FCP472 AKEBONO

FCP472 AKEBONO

FCP472 AKEBONO

FCP472 AKEBONO

FCP472 AKEBONO

FCP472 AKEBONO

FCP472 AKEBONO

FCP472 AKEBONO

FCP956 NISSIN

For material availability see page 16-18 / Per la disponibilità materiali vedere a pagina 16-18



KW



...ROVER					NOTE			NOTE
620								
2.0 16V		04/93 → 02/96	FCP904	AKEBONO	14" wheel			
2.0 16V		04/93 → 02/96	FCP905	AKEBONO	15" wheel			
2.0 16V		04/93 → 02/96				FCP956	NISSIN	
2.0 TD	77	04/93 → 06/99	FCP904	AKEBONO	14" wheel			
2.0 TD	77	04/93 → 06/99	FCP905	AKEBONO	15" wheel			
2.0 TD	77	04/93 → 06/99				FCP956	NISSIN	
623								
2.3 16V	116	04/93 → 06/99	FCP904	AKEBONO	14" wheel			
2.3 16V	116	04/93 → 06/99	FCP905	AKEBONO	15" wheel			
2.3 16V	116	04/93 → 06/99				FCP956	NISSIN	
820								
2.0 16V	98, 100	11/91 → 09/93	FCP613	LUCAS/TRW				
2.0 Sterling 16V	100	01/93 → 10/98	FCP613	LUCAS/TRW				
2.0 Turbo 16V	132	11/91 → 09/93	FCP613	LUCAS/TRW				
825								
2.5	86	01/93 → 10/98	FCP613	LUCAS/TRW				
2.5 Sterling	129	01/93 → 10/98	FCP613	LUCAS/TRW				
827								
2.7 24V	124	01/93 → 01/96	FCP613	LUCAS/TRW				
2.7 Sterling 24V		01/93 → 01/96	FCP613	LUCAS/TRW				
Allegro								
		01/73 → 12/82	FCP810	LUCAS/TRW				
All i		01/73 → 12/82	FCP810	LUCAS/TRW				
Cityrover								
1.4 i 16V	62	01/04 →	FCP613	LUCAS/TRW				
Dolomite								
1.3	42	01/76 → 12/80	FCP809	LUCAS/TRW				
1.5	52	01/76 → 12/80	FCP809	LUCAS/TRW				
1.9	67	01/76 → 12/80	FCP809	LUCAS/TRW				
2.0	92	01/73 → 12/80	FCP809	LUCAS/TRW				
Healey								
3.0 BJ7 Mark II	100	01/62 → 12/64	FCP9	LUCAS/TRW				
3.0 BJ8 Mark III	112	01/64 → 12/67	FCP167	LUCAS/TRW				
3.0 BJ8 Mark III	112	01/64 → 12/67				FCP815	LUCAS/TRW	
Ital								
1.3	44	01/80 → 12/84	FCP810	LUCAS/TRW				
1.3 440	44	05/82 → 12/87	FCP810	LUCAS/TRW				
1.3 575	44	05/82 → 12/87	FCP810	LUCAS/TRW				
1.5 440		05/82 → 12/87	FCP810	LUCAS/TRW				
1.5 575		05/82 → 12/87	FCP810	LUCAS/TRW				
1.7	59	01/80 → 12/84	FCP810	LUCAS/TRW				
1.7 440	59	05/82 → 12/87	FCP810	LUCAS/TRW				
1.7 575	59	05/82 → 12/87	FCP810	LUCAS/TRW				
2.0	69	01/80 → 12/84	FCP810	LUCAS/TRW				
Ital van								
1.3 440, 575	44	05/82 → 12/87	FCP810	LUCAS/TRW				
1.5 440, 575		05/82 → 12/87	FCP810	LUCAS/TRW				
1.7 440, 575	59	05/82 → 12/87	FCP810	LUCAS/TRW				
Marina								
		01/71 → 12/80	FCP810	LUCAS/TRW				
1.3 i 440		01/72 → 12/78	FCP810	LUCAS/TRW				
1.3 i 575		01/72 → 12/78	FCP810	LUCAS/TRW				
1.8 i 440		01/72 → 12/78	FCP810	LUCAS/TRW				
1.8 i 440		01/79 → 04/82	FCP810	LUCAS/TRW				
1.8 i 575		01/72 → 12/78	FCP810	LUCAS/TRW				
1.8 i 575		01/79 → 04/82	FCP810	LUCAS/TRW				
All i		01/71 → 12/80	FCP810	LUCAS/TRW				
Marina van								
1.3 440, 575		01/72 → 12/78	FCP810	LUCAS/TRW				
1.8 440, 575		01/72 → 12/78	FCP810	LUCAS/TRW				
1.8 440, 575		01/79 → 04/82	FCP810	LUCAS/TRW				

For material availability see page 16-18 / Per la disponibilità materiali vedere a pagina 16-18



KW

**...ROVER****Maxi**

1.5	46	01/69 → 12/82	FCP810	LUCAS/TRW			
1.7	54	01/69 → 12/82	FCP810	LUCAS/TRW			

Metro

1.0	31, 35	10/80 → 05/90	FCP840	LOCKHEED			
1.0 i	31, 35	01/85 → 05/90	FCP840	LOCKHEED			
1.3	45, 46	10/80 → 05/90	FCP840	LOCKHEED			
1.3 i	45, 46	01/84 → 05/90	FCP840	LOCKHEED			

Metro Van

1.3		01/82 → 05/90	FCP840	LOCKHEED			
1.3 i		01/84 → 05/90	FCP840	LOCKHEED			

Mini

1.3	41, 53	01/69 → 12/80	FCP825	LOCKHEED	10" wheel		
1.3 Cooper		01/63 → 12/69	FCP342	LOCKHEED			
1.3 Cooper S		01/63 → 12/71	FCP825	LOCKHEED			

P5B

3.5 Rover V8		01/68 → 12/69	FCP9	LUCAS/TRW			
--------------	--	---------------	------	-----------	--	--	--

P6

3.5 Rover V8		01/68 → 12/69	FCP9	LUCAS/TRW			
--------------	--	---------------	------	-----------	--	--	--

Princess

		01/75 → 12/82	FCP832	LOCKHEED			
All i		01/75 → 12/82	FCP832	LOCKHEED			

Six

All i Wolseley		01/72 → 12/74	FCP9	LUCAS/TRW			
Wolseley		01/72 → 12/74	FCP9	LUCAS/TRW			

Spitfire

1.1		01/62 → 12/80	FCP809	LUCAS/TRW			
-----	--	---------------	--------	-----------	--	--	--

Streetwise

1.4 i	62	08/03 →	FCP613	LUCAS/TRW			
2.0 TD	74	08/03 →	FCP613	LUCAS/TRW			

Toledo

		01/70 → 12/76	FCP810	LUCAS/TRW			
All i		01/70 → 12/76	FCP810	LUCAS/TRW			

SAAB**9-3 (YS3D)**

2.0 i	96	02/98 → 09/02	FCP1068	ATE			
2.0 SE Turbo	147	02/98 → 09/02	FCP1068	ATE			
2.0 Turbo	113	10/98 → 09/02	FCP1068	ATE			
2.0 Turbo	136	02/98 → 09/02	FCP1068	ATE			
2.2 TiD	85	02/98 → 11/00	FCP1068	ATE			
2.2 TiD	92	11/00 → 09/02	FCP1068	ATE			
2.3 i	110	02/98 → 09/02	FCP1068	ATE			
2.3 Turbo	165	10/98 → 09/02	FCP1068	ATE			

9-3 (YS3F)

1.8	90	11/03 → 03/09	FCP1520	ATE			
1.8t BioPower	110	01/07 →	FCP1706	ATE	For Rims 17 inch		
1.8t BioPower	110	01/07 →				FCP1931	ATE
1.8t BioPower	129	05/09 →	FCP1706	ATE	For Rims 17 inch		Until 12/08
1.8t BioPower	129	05/09 →				FCP1931	ATE
1.9 TDi	110	04/04 → 07/12	FCP1520	ATE			
1.9 TDi	88	08/04 → 07/12	FCP1520	ATE			
1.9 TTiD	118	12/07 →	FCP1520	ATE	Not for Rims 17 inch		
1.9 TTiD	118	12/07 →	FCP1706	ATE	For Rims 17 inch		
1.9 TTiD	118	12/07 →				FCP1931	ATE
1.9 TTiD	132	12/07 →	FCP1520	ATE	Not for Rims 17 inch		
1.9 TTiD	132	12/07 →	FCP1706	ATE	For Rims 17 inch		
1.9 TTiD	132	12/07 →				FCP1931	ATE
1.9 TTiD	132	12/07 →					Until 12/08
1.9 TTiD	96	12/07 →	FCP1520	ATE	Not for Rims 17 inch		
1.9 TTiD	96	12/07 →	FCP1706	ATE	For Rims 17 inch		
1.9 TTiD	96	12/07 →				FCP1931	ATE
2.0	143	04/06 → 09/07	FCP1520	ATE			

For material availability see page 16-18 / Per la disponibilità materiali vedere a pagina 16-18



KW

**...SAAB****...9-3 (YS3F)**

					NOTE			NOTE
2.0 t	120	01/07 →	FCP1520	ATE	Not for Rims 17 inch			
2.0 t	120	01/07 →	FCP1706	ATE	For Rims 17 inch			
2.0 t	120	01/07 →				FCP1931	ATE	Until 12/08
2.0 t	147	02/09 → 07/12	FCP1520	ATE				
2.0 t	147	02/09 →	FCP1520	ATE	Not for Rims 17 inch			
2.0 t	147	02/09 →	FCP1706	ATE	For Rims 17 inch			
2.0 t	147	02/09 →				FCP1931	ATE	
2.0 t	177	05/09 →	FCP1520	ATE	Not for Rims 17 inch			
2.0 t	177	05/09 →	FCP1706	ATE	For Rims 17 inch			
2.0 t	177	05/09 →				FCP1931	ATE	
2.0 t	185	04/04 → 08/07	FCP1520	ATE				
2.0 t BioPower	110	01/07 → 07/12	FCP1520	ATE				
2.0 t BioPower	120	01/07 →	FCP1520	ATE	Not for Rims 17 inch			
2.0 t BioPower	120	01/07 →	FCP1706	ATE	For Rims 17 inch			
2.0 t BioPower	120	01/07 →				FCP1931	ATE	Until 12/08
2.0 t BioPower	129	01/07 →	FCP1520	ATE	Not for Rims 17 inch			
2.0 t BioPower	129	01/07 →	FCP1706	ATE	For Rims 17 inch			
2.0 t BioPower	129	01/07 →				FCP1931	ATE	
2.0 t BioPower	145	06/07 →	FCP1520	ATE				
2.0 t BioPower	145	06/07 →	FCP1706	ATE	For Rims 17 inch			
2.0 t BioPower	145	06/07 →				FCP1931	ATE	Until 12/08
2.0 t BioPower	147	05/09 →	FCP1520	ATE	Not for Rims 17 inch			
2.0 t BioPower	147	05/09 →	FCP1520	ATE				
2.0 t BioPower	147	05/09 →	FCP1706	ATE	For Rims 17 inch			
2.0 t BioPower	147	05/09 →				FCP1931	ATE	
2.0 t BioPower	154	09/02 →	FCP1706	ATE	For Rims 17 inch			
2.0 t BioPower	154	09/02 →	FCP1520	ATE	Not for Rims 17 inch			
2.0 t BioPower	154	09/02 →				FCP1931	ATE	Until 12/08
2.0 t BioPower XWD	120	01/08 →	FCP1520	ATE				
2.0 t BioPower XWD	120	01/08 →	FCP1706	ATE	For Rims 17 inch			
2.0 t BioPower XWD	120	01/08 →				FCP1931	ATE	
2.0 t BioPower XWD	154	01/08 →	FCP1520	ATE	Not for Rims 17 inch			
2.0 t BioPower XWD	154	01/08 →	FCP1706	ATE	For Rims 17 inch			
2.0 t BioPower XWD	154	01/08 →				FCP1931	ATE	Until 12/08
2.0 t BioPower XWD	162	01/08 →	FCP1520	ATE	Not for Rims 17 inch			
2.0 t BioPower XWD	162	01/08 →	FCP1706	ATE	For Rims 17 inch			
2.0 t BioPower XWD	162	01/08 →				FCP1931	ATE	
2.0 t XWD	120	01/07 →	FCP1520	ATE				
2.0 t XWD	120	01/07 →	FCP1706	ATE	For Rims 17 inch			
2.0 t XWD	120	01/07 →				FCP1931	ATE	Until 12/08
2.0 t XWD	162	01/08 →	FCP1520	ATE	Not for Rims 17 inch			
2.0 t XWD	162	01/08 →	FCP1706	ATE	For Rims 17 inch			
2.0 t XWD	162	01/08 →				FCP1931	ATE	
2.0 Turbo XWD	154	01/08 →	FCP1520	ATE	Not for Rims 17 inch			
2.0 Turbo XWD	154	01/08 →	FCP1706	ATE	For Rims 17 inch			
2.0 Turbo XWD	154	01/08 →				FCP1931	ATE	
2.8 Turbo V6	169	03/05 →	FCP1520	ATE	Not for Rims 17 inch			
2.8 Turbo V6	169	03/05 →	FCP1706	ATE	For Rims 17 inch			
2.8 Turbo V6	169	03/05 →				FCP1931	ATE	Until 12/08
2.8 Turbo V6	184	06/05 → 07/12	FCP1520	ATE				
2.8 Turbo V6	188	12/07 →	FCP1520	ATE	Not for Rims 17 inch			
2.8 Turbo V6	188	12/07 →	FCP1706	ATE	For Rims 17 inch			
2.8 Turbo V6	188	12/07 →				FCP1931	ATE	Until 12/08
2.8 Turbo V6	203	04/08 →	FCP1706	ATE				
2.8 Turbo V6	203	04/08 →				FCP1931	ATE	Until 12/08
2.8 Turbo V6 XWD	206	05/08 →	FCP1706	ATE				
2.8 Turbo V6 XWD	206	05/08 →				FCP1931	ATE	Until 12/08

9-3 Convertible (YS3F)

1.8t BioPower	110	01/07 →	FCP1706	ATE	For Rims 17 inch			
1.8t BioPower	110	01/07 →				FCP1931	ATE	Until 12/08
1.8t BioPower	129	01/07 →	FCP1706	ATE	For Rims 17 inch			
1.8t BioPower	129	01/07 →				FCP1931	ATE	Until 12/08
1.9 TDi	110	02/06 → 07/12	FCP1520	ATE				
1.9 TTiD	118	12/07 →	FCP1520	ATE	Not for Rims 17 inch			
1.9 TTiD	118	12/07 →	FCP1706	ATE	For Rims 17 inch			
1.9 TTiD	118	12/07 →				FCP1931	ATE	
1.9 TTiD	132	12/07 →	FCP1520	ATE	Not for Rims 17 inch			
1.9 TTiD	132	12/07 →	FCP1706	ATE	For Rims 17 inch			
1.9 TTiD	132	12/07 →				FCP1931	ATE	Until 12/08
1.9 TTiD	96	12/07 →	FCP1520	ATE	Not for Rims 17 inch			
1.9 TTiD	96	12/07 →	FCP1706	ATE	For Rims 17 inch			
1.9 TTiD	96	12/07 →				FCP1931	ATE	Until 12/08
2.0	129	08/03 → 07/12	FCP1520	ATE				
2.0	143	04/06 → 09/07	FCP1520	ATE				
2.0 t	120	01/11 →	FCP1520	ATE	Not for Rims 17 inch			
2.0 t	120	01/11 →	FCP1706	ATE	For Rims 17 inch			

For material availability see page 16-18 / Per la disponibilità materiali vedere a pagina 16-18

1192

FERODO

RACING

Updated on 17th Aug 2018



KW



...SAAB

...9-3 Convertible (YS3F)

					NOTE			NOTE
2.0 t	120	01/11 →	FCP1520	ATE		FCP1931	ATE	
2.0 t	154	07/03 → 07/12	FCP1706	ATE				
2.0 t	162	01/11 →	FCP1706	ATE	For Rims 17 inch			
2.0 t	162	01/11 →	FCP1520	ATE	Not for Rims 17 inch			
2.0 t	162	01/11 →				FCP1931	ATE	
2.0 t	185	04/04 → 08/07	FCP1520	ATE				
2.0 t BioPower	120	01/11 →	FCP1520	ATE	Not for Rims 17 inch			
2.0 t BioPower	120	01/11 →	FCP1706	ATE	For Rims 17 inch			
2.0 t BioPower	120	01/11 →				FCP1931	ATE	
2.0 t BioPower	129	01/07 →	FCP1520	ATE	Not for Rims 17 inch			
2.0 t BioPower	129	01/07 → 07/12	FCP1520	ATE				
2.0 t BioPower	129	01/07 →	FCP1706	ATE	For Rims 17 inch			
2.0 t BioPower	129	01/07 →				FCP1931	ATE	Until 12/08
2.0 t BioPower	147	06/07 →	FCP1706	ATE	For Rims 17 inch			
2.0 t BioPower	147	06/07 →	FCP1520	ATE	Not for Rims 17 inch			
2.0 t BioPower	147	06/07 →				FCP1931	ATE	Until 12/08
2.0 t BioPower	162	01/11 →	FCP1706	ATE	For Rims 17 inch			
2.0 t BioPower	162	01/11 →	FCP1520	ATE	Not for Rims 17 inch			
2.0 t BioPower	162	01/11 →				FCP1931	ATE	
2.8 Turbo V6	169	02/06 →	FCP1520	ATE	Not for Rims 17 inch			
2.8 Turbo V6	169	02/06 →	FCP1706	ATE	For Rims 17 inch			
2.8 Turbo V6	169	02/06 →				FCP1931	ATE	Until 12/08
2.8 Turbo V6	184	06/05 → 07/12	FCP1520	ATE				
2.8 Turbo V6	188	12/07 →	FCP1520	ATE	Not for Rims 17 inch			
2.8 Turbo V6	188	12/07 →	FCP1706	ATE	For Rims 17 inch			
2.8 Turbo V6	188	12/07 →				FCP1931	ATE	Until 12/08
2.8 Turbo V6	203	02/09 →	FCP1706	ATE				
2.8 Turbo V6	203	02/09 →				FCP1931	ATE	
2.8 Turbo V6	206	02/09 →	FCP1706	ATE				
2.8 Turbo V6	206	02/09 →				FCP1931	ATE	

9-3 Estate

1.8	90	03/05 → 03/09	FCP1520	ATE				
1.8 t	110	03/05 →	FCP1706	ATE	For Rims 17 inch			
1.8 t	110	03/05 →				FCP1931	ATE	Until 12/08
1.8 t BioPower	110	01/07 →	FCP1706	ATE	For Rims 17 inch			
1.8 t BioPower	110	01/07 →				FCP1931	ATE	Until 12/08
1.9 TDi	110	02/05 → 07/12	FCP1520	ATE				
1.9 TDi	88	02/05 → 07/12	FCP1520	ATE				
1.9 TTiD	118	12/07 →	FCP1520	ATE	Not for Rims 17 inch			
1.9 TTiD	118	12/07 →	FCP1706	ATE	For Rims 17 inch			
1.9 TTiD	118	12/07 →				FCP1931	ATE	
1.9 TTiD	132	12/07 →	FCP1520	ATE	Not for Rims 17 inch			
1.9 TTiD	132	12/07 →	FCP1706	ATE	For Rims 17 inch			
1.9 TTiD	132	12/07 →				FCP1931	ATE	Until 12/08
1.9 TTiD	96	12/07 →	FCP1520	ATE	Not for Rims 17 inch			
1.9 TTiD	96	12/07 →	FCP1706	ATE	For Rims 17 inch			
1.9 TTiD	96	12/07 →				FCP1931	ATE	
2.0	110	03/05 → 07/12	FCP1520	ATE				
2.0	143	04/06 → 09/07	FCP1520	ATE				
2.0 t	120	01/07 →	FCP1520	ATE	Not for Rims 17 inch			
2.0 t	120	01/07 →	FCP1706	ATE	For Rims 17 inch			
2.0 t	120	01/07 →				FCP1931	ATE	Until 12/08
2.0 t	129	02/05 → 07/12	FCP1520	ATE				
2.0 t	154	03/05 → 07/12	FCP1520	ATE				
2.0 t	177	05/09 → 07/12	FCP1520	ATE				
2.0 t BioPower	129	01/07 → 07/12	FCP1520	ATE				
2.0 t BioPower	129	01/07 →	FCP1706	ATE	For Rims 17 inch			
2.0 t BioPower	129	01/07 →	FCP1520	ATE	Not for Rims 17 inch			
2.0 t BioPower	129	01/07 →				FCP1931	ATE	Until 12/08
2.0 t BioPower	145	06/07 →	FCP1520	ATE	Not for Rims 17 inch			
2.0 t BioPower	145	06/07 →	FCP1706	ATE	For Rims 17 inch			
2.0 t BioPower	145	06/07 →				FCP1931	ATE	Until 12/08
2.0 t BioPower	147	02/09 →	FCP1520	ATE	Not for Rims 17 inch			
2.0 t BioPower	147	02/09 →	FCP1706	ATE	For Rims 17 inch			
2.0 t BioPower	147	02/09 →				FCP1931	ATE	
2.0 t BioPower	162	01/11 → 07/12	FCP1520	ATE				
2.0 t BioPower XWD	120	01/11 →	FCP1706	ATE	For Rims 17 inch			
2.0 t BioPower XWD	120	01/11 →	FCP1520	ATE	Not for Rims 17 inch			
2.0 t BioPower XWD	120	01/11 →				FCP1931	ATE	
2.0 t BioPower XWD	154	06/08 →	FCP1520	ATE	Not for Rims 17 inch			
2.0 t BioPower XWD	154	06/08 →	FCP1706	ATE	For Rims 17 inch			
2.0 t BioPower XWD	154	06/08 →				FCP1931	ATE	Until 12/08
2.0 t XWD	120	01/07 →	FCP1520	ATE	Not for Rims 17 inch			
2.0 t XWD	120	01/07 →	FCP1706	ATE	For Rims 17 inch			
2.0 t XWD	120	01/07 →				FCP1931	ATE	
2.0 t XWD	154	06/08 →	FCP1520	ATE	Not for Rims 17 inch			

For material availability see page 16-18 / Per la disponibilità materiali vedere a pagina 16-18



KW



SAAB

...SAAB					NOTE			NOTE
...9-3 Estate								
2.0 t XWD	154	06/08 →	FCP1706	ATE	For Rims 17 inch			
2.0 t XWD	154	06/08 →				FCP1931	ATE	
2.0 t XWD	162	01/11 →	FCP1520	ATE	Not for Rims 17 inch			
2.0 t XWD	162	01/11 →	FCP1706	ATE	For Rims 17 inch			
2.0 t XWD	162	01/11 →				FCP1931	ATE	
2.8 Turbo V6	169	03/05 →	FCP1520	ATE	Not for Rims 17 inch			
2.8 Turbo V6	169	03/05 →	FCP1706	ATE	For Rims 17 inch			
2.8 Turbo V6	169	03/05 →				FCP1931	ATE	Until 12/08
2.8 Turbo V6	184	06/05 → 07/12	FCP1520	ATE				
2.8 Turbo V6	188	12/07 →	FCP1520	ATE	Not for Rims 17 inch			
2.8 Turbo V6	188	12/07 →	FCP1706	ATE	For Rims 17 inch			
2.8 Turbo V6	188	12/07 →				FCP1931	ATE	Until 12/08
2.8 Turbo V6	203	05/08 →	FCP1706	ATE				
2.8 Turbo V6	203	05/08 →				FCP1931	ATE	Until 12/08
2.8 Turbo V6 XWD	206	05/08 →	FCP1706	ATE				
2.8 Turbo V6 XWD	206	05/08 →				FCP1931	ATE	Until 12/08
9-3 Sport (D45/D49)								
2.0	110	09/02 → 07/12	FCP1520	ATE				
2.0	110	09/02 → 07/12				FCP1540	ATE	
2.0 Turbo	129	06/02 → 07/12	FCP1520	ATE				
2.0 Turbo	129	06/02 → 07/12				FCP1540	ATE	
2.2 TiD	92	06/02 → 10/04	FCP1520	ATE				
2.2 TiD	92	06/02 → 10/04				FCP1540	ATE	
9-3 Sport (D46/D49)								
2.0 Turbo	154	09/02 → 07/12	FCP1520	ATE				
2.0 Turbo	154	09/02 → 07/12				FCP1540	ATE	
9-3X								
1.9 TTiD	132	02/09 →	FCP1520	ATE	Not for Rims 17 inch			
1.9 TTiD	132	02/09 →	FCP1706	ATE	For Rims 17 inch			
1.9 TTiD	132	02/09 →				FCP1931	ATE	
2.0 t BioPower	162	01/11 → 07/12	FCP1520	ATE				
2.0 t BioPower	162	01/11 →	FCP1706	ATE	For Rims 17 inch			
2.0 t BioPower	162	01/11 →	FCP1520	ATE	Not for Rims 17 inch			
2.0 t BioPower	162	01/11 →				FCP1931	ATE	
2.0 t BioPower XWD	154	02/09 →	FCP1520	ATE	Not for Rims 17 inch			
2.0 t BioPower XWD	154	02/09 →	FCP1706	ATE	For Rims 17 inch			
2.0 t BioPower XWD	154	02/09 →				FCP1931	ATE	
2.0 t XWD	154	02/09 →	FCP1520	ATE	Not for Rims 17 inch			
2.0 t XWD	154	02/09 →	FCP1706	ATE	For Rims 17 inch			
2.0 t XWD	154	02/09 →				FCP1931	ATE	
9-5 (YS3E)								
2.0 t	110	09/97 →	FCP1068	ATE				
2.3 t	125	09/97 →	FCP1068	ATE				
3.0 V6t	147	01/98 →	FCP1068	ATE				
90								
2.0 i L	73	09/84 → 12/87				FCP3	ATE	
900								
2.0	74	10/78 → 12/80				FCP3	ATE	
2.0	74	10/80 → 08/87				FCP3	ATE	
2.0 16V	98, 136	09/93 → 07/96	FCP685	ATE				
2.0 16V	98, 136	09/93 → 07/96				FCP586	ATE	
2.3 16V	110	09/93 → 07/96	FCP685	ATE				
2.3 16V	110	09/93 → 07/96				FCP586	ATE	
2.3 16V	110	08/96 → 05/98	FCP1068	ATE				
2.5 24V	125	08/96 → 05/98	FCP1068	ATE				
2.5 V6 24V	125	09/93 → 07/96	FCP685	ATE				
2.5 V6 24V	125	09/93 → 07/96				FCP586	ATE	
900 II								
2.0 -16 Turbo	136	07/93 → 02/98	FCP1068	ATE				
2.0 i	96	08/94 → 02/98	FCP1068	ATE				
900 II Convertible								
2.0 -16 Turbo	136	12/93 → 02/98	FCP1068	ATE				
2.0 i	96	12/93 → 02/98	FCP1068	ATE				

For material availability see page 16-18 / Per la disponibilità materiali vedere a pagina 16-18



KW



...SAAB

900 II Coupe

2.0 -16 Turbo	136	12/93 → 02/98	FCP1068	ATE			
2.0 i	96	08/94 → 02/98	FCP1068	ATE			
2.0 i	98	12/93 → 07/94	FCP1068	ATE			

9000

2.0 -16	94	01/89 → 01/93	FCP660	LUCAS/TRW	ABS		
2.0 -16 CD	96	09/93 → 12/98	FCP660	LUCAS/TRW	ABS		
2.0 -16 Turbo	118	05/88 → 08/93	FCP660	LUCAS/TRW	ABS		
2.0 -16 Turbo CD	136	09/89 → 12/98	FCP660	LUCAS/TRW			

9000 Hatchback

2.0 -16	94	12/85 → 08/88	FCP660	LUCAS/TRW	ABS		
2.0 -16 CS	94	01/89 → 12/98	FCP660	LUCAS/TRW	ABS		
2.0 -16 CS	96	09/93 → 12/98	FCP660	LUCAS/TRW	ABS		
2.0 -16 Turbo	118	09/84 → 08/93	FCP660	LUCAS/TRW	ABS		

99

2.0	69	01/69 → 09/74	FCP2	ATE			
2.0	69	01/69 → 09/74				FCP3	ATE
2.0 EMS	87	09/74 → 12/78				FCP3	ATE
2.0 GL	74	09/74 → 12/84				FCP3	ATE

99 Combi Coupe

2.0	74	09/74 → 12/79				FCP3	ATE
2.0 i	87	01/81 → 12/84				FCP3	ATE
2.0 Turbo	107	10/77 → 06/80				FCP3	ATE

SAO

Penza

1.3	50, 55	01/91 → 12/94	FCP487	SUMITOMO			
-----	--------	---------------	--------	----------	--	--	--

SCION

FR-S

2.0 L	147	03/12 →	FCP1639	SUMITOMO			
2.0 L	147	03/12 →				FCP4187	SUMITOMO

SEAT

124

		01/68 → 12/83	FCP29	BENDIX			
All i		01/68 → 12/83	FCP29	BENDIX			

127

0.9 Not C, CL	36	01/71 → 12/82	FCP29	BENDIX			
1.0	39	01/71 → 12/86	FCP29	BENDIX			
1.0 i		01/83 → 12/86	FCP29	BENDIX			

128

		01/72 → 12/85	FCP29	BENDIX			
All i		01/72 → 12/85	FCP29	BENDIX			

131

1.4	55	01/75 → 12/85	FCP29	BENDIX			
1.6	72	01/75 → 12/85	FCP29	BENDIX			
1.8 CLX		01/75 → 12/85	FCP29	BENDIX			
2.0	83	01/75 → 12/85	FCP29	BENDIX			
2.4	54	01/75 → 12/85	FCP29	BENDIX			

132

1.8		01/74 → 12/79	FCP29	BENDIX			
2.0		01/79 → 12/83	FCP29	BENDIX			

SEAT

For material availability see page 16-18 / Per la disponibilità materiali vedere a pagina 16-18



KW



...SEAT

133

0.8 25 01/74 → 12/82 FCP29 BENDIX

1430

01/71 → 12/83 FCP29 BENDIX
01/71 → 12/83 FCP29 BENDIX

850

All i 01/75 → 12/79 FCP29 BENDIX

Alhambra

1.8 20V 110 11/95 → 04/00 FCP590 ATE
1.8 20V 110 11/95 → 04/00 FCP590 ATE
1.9 TDi 11/95 → 04/00 FCP590 ATE
1.9 TDi 11/95 → 04/00 FCP590 ATE
2.0 85 11/95 → 04/00 FCP590 ATE
2.0 85 11/95 → 04/00 FCP590 ATE

ALHAMBRA (710, 711)

1.4 TSI 110 06/10 → FCP4425 LUCAS/TRW PR 1LX,1LW(314mm disc)
1.4 TSI 110 06/10 → FCP1636 LUCAS/TRW
2.0 TDI 100 06/10 → 05/11 FCP4425 LUCAS/TRW PR 1LX,1LW(314mm disc)
2.0 TDI 100 06/10 → 05/11 FCP1636 LUCAS/TRW
2.0 TDI 103 06/10 → FCP4425 LUCAS/TRW PR 1LX,1LW(314mm disc)
2.0 TDI 103 06/10 → FCP1636 LUCAS/TRW
2.0 TDI 125 06/10 → FCP4425 LUCAS/TRW PR 1LX,1LW(314mm disc)
2.0 TDI 125 06/10 → FCP1636 LUCAS/TRW
2.0 TDI 85 05/11 → FCP4425 LUCAS/TRW PR 1LX,1LW(314mm disc)
2.0 TDI 85 05/11 → FCP1636 LUCAS/TRW
2.0 TDI 4Drive 103 05/11 → FCP4425 LUCAS/TRW PR 1LX,1LW(314mm disc)
2.0 TDI 4Drive 103 05/11 → FCP1636 LUCAS/TRW
2.0 TSI 147 11/10 → FCP4425 LUCAS/TRW PR 1LX,1LW(314mm disc)
2.0 TSI 147 11/10 → FCP1636 LUCAS/TRW

Altea

1.6 i 75 06/04 → FCP1094 ATE
1.9 TDi 77 06/04 → FCP1094 ATE
2.0 FSi 110 06/04 → FCP1641 ATE
2.0 TDi 103 06/04 → FCP1641 ATE

Arosa

1.0 37 05/97 → FCP1101 ATE
1.4 44 05/97 → FCP1101 ATE
1.7 SDi 42 05/97 → FCP1101 ATE

Arosa (6H)

1.4 i 16V 74 01/00 → FCP1312 LUCAS/TRW

ATECA (KH7)

1.0 TSI 85 05/16 → FCP4433 TRW Disc Diam mm:312,For PR code:1ZA
1.0 TSI 85 05/16 → FCP4434 ATE Disc Diam mm:272,For PR code:1KE
1.4 TSI 110 06/16 → FCP4433 TRW Disc Diam mm:312,For PR code:1ZA
1.4 TSI 110 06/16 → FCP4434 ATE Disc Diam mm:272,For PR code:1KE
1.4 TSI 4Drive 110 06/16 → FCP4433 TRW Disc Diam mm:312,For PR code:1ZA
1.4 TSI 4Drive 110 06/16 → FCP4434 ATE Disc Diam mm:272,For PR code:1KE
1.6 TDI 85 04/16 → FCP4433 TRW Disc Diam mm:312,For PR code:1ZA
1.6 TDI 85 04/16 → FCP4434 ATE Disc Diam mm:272,For PR code:1KE
2.0 TDI 105 10/16 → FCP4433 TRW
2.0 TDI 105 10/16 → FCP4434 ATE
2.0 TDI 110 04/16 → FCP4433 TRW Disc Diam mm:312,For PR code:1ZA
2.0 TDI 110 04/16 → FCP4434 ATE Disc Diam mm:272,For PR code:1KE
2.0 TDI 81 10/16 → FCP4433 TRW
2.0 TDI 81 10/16 → FCP4434 ATE
2.0 TDI 4Drive 110 04/16 → FCP4433 TRW Disc Diam mm:312,For PR code:1ZA
2.0 TDI 4Drive 110 04/16 → FCP4434 ATE Disc Diam mm:272,For PR code:1KE
2.0 TDI 4Drive 140 06/16 → FCP4433 TRW Disc Diam mm:312,For PR code:1ZA
2.0 TDI 4Drive 140 06/16 → FCP4434 ATE Disc Diam mm:272,For PR code:1KE

Cordoba

1.0 37 01/93 → FCP385 KELGATE
1.3 01/93 → FCP385 KELGATE
1.4 44 01/93 → 05/96 FCP419 KELGATE
1.4 44 01/93 → 05/96 FCP385 KELGATE
1.4 44 06/96 → 06/99 FCP1054 ATE
1.6 55 01/93 → 05/95 FCP419 KELGATE
1.6 55, 74 06/95 → 06/99 FCP419 KELGATE

For material availability see page 16-18 / Per la disponibilità materiali vedere a pagina 16-18

1196

FERODO

RACING

Updated on 17th Aug 2018

SEAT



KW

**...SEAT****...Cordoba**

				NOTE			NOTE
1.6	55, 74	06/95 → 06/99	FCP1054	ATE			
1.8	66	06/95 → 06/99	FCP419	KELGATE			
1.8	66	06/95 → 06/99	FCP1054	ATE			
1.8	66, 95	01/93 → 05/95	FCP419	KELGATE			
1.8 16V	95	01/94 → 06/99	FCP774	LUCAS/TRW	Vented		
1.8 16V	95	01/94 → 06/99				FCP541	LUCAS/TRW
1.9 TDi	150	01/97 →	FCP1312	LUCAS/TRW			
1.9 TDi	150	01/97 →				FCP541	LUCAS/TRW
1.9 TDi	55, 66	06/95 → 06/99	FCP419	KELGATE			
1.9 TDi	55, 66	06/95 → 06/99	FCP1054	ATE			
2.0 GT	85	01/93 →	FCP774	LUCAS/TRW			
2.0 GT	85	01/93 →				FCP541	LUCAS/TRW

CORDOBA (6K1, 6K2)

1.9 D	47	01/96 → 08/96	FCP1054	ATE			
1.9 D	50	02/93 → 08/96	FCP419	KELGATE			
1.9 D	50	02/93 → 08/96	FCP1054	ATE			
1.9 SDI	47	08/96 → 06/99	FCP1054	ATE			
1.9 TD	55	02/93 → 08/96	FCP419	KELGATE			
1.9 TD	55	02/93 → 08/96	FCP1054	ATE			

Cordoba (I)

1.0 i	37	07/96 → 06/99	FCP1054	ATE			
1.0 i	37	07/96 → 06/99	FCP1288	ATE			
1.4 i	44	06/94 → 06/99	FCP419	KELGATE			
1.4 i	44	06/94 → 06/99	FCP385	KELGATE			
1.4 i	44	06/94 → 06/99	FCP1054	ATE			
1.4 i	44	06/94 → 06/99	FCP1288	ATE			
1.4 i , Vario 16V	74	09/96 → 06/99	FCP1054	ATE			
1.4 i , Vario 16V	74	09/96 → 06/99	FCP1288	ATE			
1.6 i , Vario	55	02/93 → 06/99	FCP419	KELGATE			
1.6 i , Vario	55	02/93 → 06/99	FCP1054	ATE			
1.6 i , Vario	74	07/96 → 06/99	FCP1312	LUCAS/TRW			
1.6 i , Vario	74	07/96 → 06/99	FCP1054	ATE			
1.7 SDi , Vario	44	07/97 → 06/99	FCP1054	ATE			
1.7 SDi , Vario	44	07/97 → 06/99	FCP1288	ATE			
1.8 i	66	02/93 → 06/99	FCP419	KELGATE			
1.8 i	66	02/93 → 06/99	FCP1054	ATE			
1.8 i	66	02/93 → 06/99	FCP392	KELGATE			
1.8 i	66	02/93 → 06/99	FCP1288	ATE			
1.8 i 16V	95	01/94 → 08/96	FCP774	LUCAS/TRW			
1.8 i 16V	95	01/94 → 08/96	FCP1312	LUCAS/TRW			
1.8 i 16V	95	01/94 → 08/96				FCP541	LUCAS/TRW
1.9 D, SDi , Vario	47	01/96 → 06/99	FCP1054	ATE			
1.9 D, SDi , Vario	47	01/96 → 06/99	FCP1288	ATE			
1.9 D, TD	50, 55	08/93 → 08/96	FCP419	KELGATE			
1.9 D, TD	50, 55	08/93 → 08/96	FCP1054	ATE			
1.9 D, TD	50, 55	08/93 → 08/96	FCP392	KELGATE			
1.9 D, TD	50, 55	08/93 → 08/96	FCP1288	ATE			
1.9 TDi , Vario	66, 81	08/96 → 06/99	FCP1312	LUCAS/TRW			
1.9 TDi , Vario	66, 81	08/96 → 06/99				FCP541	LUCAS/TRW
2.0 i 16V	85	08/96 → 06/99	FCP775	LUCAS/TRW			
2.0 i GT	85	01/93 → 06/99	FCP1312	LUCAS/TRW			
2.0 i GT	85	01/93 → 06/99				FCP541	LUCAS/TRW

Cordoba (I) Facelift (6K2)

1.8 T 20V Cupra	115	07/00 → 10/08	FCP1348	BREMBO			
-----------------	-----	---------------	---------	--------	--	--	--

Cordoba (II)

1.4 i , Vario 8V, 16V	44, 55	06/99 → 09/02	FCP1288	ATE			
1.6 i , Vario	55	06/99 → 09/02	FCP1288	ATE			
1.6 i , Vario	74	06/99 → 09/02	FCP1288	ATE			
1.6 i , Vario	74	06/99 → 09/02	FCP1312	LUCAS/TRW			
1.9 SDi , Vario	50	06/99 → 09/02	FCP1288	ATE			
1.9 TDi , Vario	66	06/99 → 09/02	FCP1288	ATE			
1.9 TDi , Vario	66	06/99 → 09/02	FCP1312	LUCAS/TRW			
1.9 TDi , Vario	81	06/99 → 09/02	FCP1312	LUCAS/TRW			

Cordoba (III)

1.2 i	47	10/02 →	FCP1094	ATE			
1.2 i 12V	51	05/06 →	FCP1419	LUCAS/TRW			
1.4 i 16V	55	09/02 → 12/07	FCP1094	ATE			
1.4 i 16V	55	09/02 → 12/07	FCP1419	LUCAS/TRW			
1.4 i 16V	55	10/02 →	FCP1094	ATE			
1.4 i 16V	63	05/06 →	FCP1419	LUCAS/TRW			
1.4 i 16V	74	10/02 →	FCP1419	LUCAS/TRW			

For material availability see page 16-18 / Per la disponibilità materiali vedere a pagina 16-18



KW



...SEAT

...Cordoba (III)

1.4 TDi	51	05/05 →	FCP1419	LUCAS/TRW		
1.4 TDi	55	10/02 →	FCP1094	ATE		
1.4 TDi	55	10/02 → 12/05	FCP1094	ATE		
1.4 TDi	55	10/02 → 12/05	FCP1419	LUCAS/TRW		
1.4 TDi	59	06/05 →	FCP1419	LUCAS/TRW		

Cordoba Vario

1.4	44	01/96 →	FCP1054	ATE		
1.6		01/96 →	FCP1054	ATE		
1.7 SDi		01/96 →	FCP1054	ATE		
1.9 SDi		01/96 →	FCP1288	ATE		
1.9 TDi		01/96 →	FCP1312	LUCAS/TRW		
1.9 TDi		01/96 →			FCP541	LUCAS/TRW

CORDOBA Vario (6K5)

1.9 SDi	47	09/96 → 06/99	FCP1054	ATE		
---------	----	---------------	---------	-----	--	--

EXEO (3R2)

1.6	75	03/09 → 09/10	FCP1717	ATE	PR1LB,1LE(288mm disc)1LT,1LF(312mm disc)	
1.6	75	03/09 → 09/10				FCP1491 LUCAS/TRW
1.6	75	03/09 → 09/10				FCP1636 LUCAS/TRW
1.8 T	110	12/08 → 05/10	FCP1717	ATE	PR1LB,1LE(288mm disc)1LT,1LF(312mm disc)	
1.8 T	110	12/08 → 05/10				FCP1491 LUCAS/TRW
1.8 T	110	12/08 → 05/10				FCP1636 LUCAS/TRW
2.0 TDi	105	12/08 →	FCP1717	ATE	PR1LB,1LE(288mm disc)1LT,1LF(312mm disc)	
2.0 TDi	105	12/08 →				FCP1491 LUCAS/TRW
2.0 TDi	105	12/08 →				FCP1636 LUCAS/TRW
2.0 TDi	125	02/09 →	FCP1717	ATE	PR1LB,1LE(288mm disc)1LT,1LF(312mm disc)	
2.0 TDi	125	02/09 →				FCP1491 LUCAS/TRW
2.0 TDi	125	02/09 →				FCP1636 LUCAS/TRW
2.0 TDi	88	12/08 →	FCP1717	ATE	PR1LB,1LE(288mm disc)1LT,1LF(312mm disc)	
2.0 TDi	88	12/08 →				FCP1491 LUCAS/TRW
2.0 TDi	88	12/08 →				FCP1636 LUCAS/TRW
2.0 TFSI	147	03/09 →	FCP1717	ATE	PR1LB,1LE(288mm disc)1LT,1LF(312mm disc)	
2.0 TFSI	147	03/09 →				FCP1491 LUCAS/TRW
2.0 TFSI	147	03/09 →				FCP1636 LUCAS/TRW

EXEO ST (3R5)

1.6	75	06/09 → 09/10	FCP1717	ATE	PR1LB,1LE(288mm disc)1LT,1LF(312mm disc)	
1.6	75	06/09 → 09/10				FCP1491 LUCAS/TRW
1.6	75	06/09 → 09/10				FCP1636 LUCAS/TRW
1.8 T	110	06/09 → 05/10	FCP1717	ATE	PR1LB,1LE(288mm disc)1LT,1LF(312mm disc)	
1.8 T	110	06/09 → 05/10				FCP1491 LUCAS/TRW
1.8 T	110	06/09 → 05/10				FCP1636 LUCAS/TRW
2.0 TDi	105	05/09 →	FCP1717	ATE	PR1LB,1LE(288mm disc)1LT,1LF(312mm disc)	
2.0 TDi	105	05/09 →				FCP1491 LUCAS/TRW
2.0 TDi	105	05/09 →				FCP1636 LUCAS/TRW
2.0 TDi	125	05/09 →	FCP1717	ATE	PR1LB,1LE(288mm disc)1LT,1LF(312mm disc)	
2.0 TDi	125	05/09 →				FCP1491 LUCAS/TRW
2.0 TDi	125	05/09 →				FCP1636 LUCAS/TRW
2.0 TDi	88	07/09 →	FCP1717	ATE	PR1LB,1LE(288mm disc)1LT,1LF(312mm disc)	
2.0 TDi	88	07/09 →				FCP1491 LUCAS/TRW
2.0 TDi	88	07/09 →				FCP1636 LUCAS/TRW
2.0 TFSI	147	06/09 →	FCP1717	ATE	PR1LB,1LE(288mm disc)1LT,1LF(312mm disc)	
2.0 TFSI	147	06/09 →				FCP1491 LUCAS/TRW
2.0 TFSI	147	06/09 →				FCP1636 LUCAS/TRW

Fura

0.9	29	01/82 → 12/85	FCP29	BENDIX		
0.9	29	01/85 → 12/87	FCP351	BENDIX		
1.4	55	01/82 → 12/85	FCP29	BENDIX		
1.4	55	01/85 → 12/87	FCP351	BENDIX		

Ibiza

0.9	29, 31	08/84 → 04/93	FCP351	BENDIX		
1.0	33, 37	05/93 →	FCP385	KELGATE		
1.2	45	08/84 → 04/93	FCP351	BENDIX		
1.2	46	08/84 → 04/93	FCP351	BENDIX		
1.2	52	08/84 → 04/93	FCP351	BENDIX		
1.3	40	05/93 →	FCP385	KELGATE		
1.4	44	06/94 →	FCP385	KELGATE		
1.6	55, 74	05/93 →	FCP419	KELGATE		
1.8	66	05/93 → 08/99	FCP419	KELGATE		
1.8	66	05/93 → 08/99			FCP541	LUCAS/TRW
1.8 16V	95	05/93 → 08/99	FCP774	LUCAS/TRW		
1.8 16V	95	05/93 → 08/99			FCP541	LUCAS/TRW

For material availability see page 16-18 / Per la disponibilità materiali vedere a pagina 16-18



KW



...SEAT

...Ibiza

					NOTE			NOTE
1.9 D	47, 48	05/93 → 08/99	FCP419	KELGATE	Solid			
1.9 D	47, 48	05/93 → 08/99	FCP774	LUCAS/TRW	Vented			
1.9 D	47, 48	05/93 → 08/99				FCP541	LUCAS/TRW	
1.9 TD	55	05/93 → 08/99	FCP419	KELGATE	Solid			
1.9 TD	55	05/93 → 08/99	FCP774	LUCAS/TRW	Vented			
1.9 TD	55	05/93 → 08/99				FCP541	LUCAS/TRW	
1.9 TDi	66	07/96 → 02/02	FCP1054	ATE				
1.9 TDi	66	07/96 → 02/02				FCP541	LUCAS/TRW	
1.9 TDi	81	07/97 → 02/02	FCP1312	LUCAS/TRW				
1.9 TDi	81	07/97 → 02/02				FCP541	LUCAS/TRW	
1.9 TDi		01/05 →	FCP1094	ATE				
2.0 i GTi, Cupra 16V	110	05/93 → 12/96	FCP774	LUCAS/TRW				
2.0 i GTi, Cupra 16V	110	05/93 → 12/96				FCP541	LUCAS/TRW	
2.0 i Sport 16V	110	01/97 → 02/02	FCP1054	ATE				

Ibiza (II)

1.3 i	40	05/93 → 08/99	FCP1054	ATE				
1.3 i	40	05/93 → 08/99	FCP1288	ATE				
1.4 i	44	09/93 → 08/99	FCP1288	ATE				
1.4 i	44	09/93 → 08/99	FCP385	KELGATE				
1.4 i	44	09/93 → 08/99	FCP1054	ATE				
1.4 i	44	09/93 → 08/99	FCP419	KELGATE				
1.4 i 16V	74	05/93 → 08/99	FCP1288	ATE				
1.4 i 16V	74	05/93 → 08/99	FCP1054	ATE				
1.6 i	55	05/93 → 08/99	FCP1054	ATE				
1.6 i	55	05/93 → 08/99	FCP419	KELGATE				
1.6 i	74	04/96 → 08/99	FCP1312	LUCAS/TRW				
1.7 SDi	44	07/97 → 08/99	FCP1054	ATE				
1.7 SDi	44	07/97 → 08/99	FCP1288	ATE				
1.8 i	66	05/93 → 08/99	FCP1054	ATE				
1.8 i	66	05/93 → 08/99	FCP419	KELGATE				
1.8 i	66	05/93 → 08/99	FCP392	KELGATE				
1.8 i	66	05/93 → 08/99	FCP1288	ATE				
1.8 i 16V	95	05/93 → 08/99	FCP774	LUCAS/TRW				
1.8 i 16V	95	05/93 → 08/99	FCP1312	LUCAS/TRW				
1.8 i 16V	95	05/93 → 08/99				FCP541	LUCAS/TRW	
1.9 D, TD	47	05/93 → 08/99	FCP1054	ATE				
1.9 D, TD	47	05/93 → 08/99	FCP1288	ATE				
1.9 D, TD	47	05/93 → 08/99	FCP419	KELGATE				
1.9 D, TD	47	05/93 → 08/99	FCP392	KELGATE				
1.9 D, TD	50	05/93 → 08/99	FCP1054	ATE				
1.9 D, TD	50	05/93 → 08/99	FCP1288	ATE				
1.9 D, TD	50	05/93 → 08/99	FCP419	KELGATE				
1.9 D, TD	50	05/93 → 08/99	FCP392	KELGATE				
1.9 D, TD	55	05/93 → 08/99	FCP1054	ATE				
1.9 D, TD	55	05/93 → 08/99	FCP1288	ATE				
1.9 D, TD	55	05/93 → 08/99	FCP419	KELGATE				
1.9 D, TD	55	05/93 → 08/99	FCP392	KELGATE				
1.9 TDi	66.81	08/96 → 08/99	FCP1312	LUCAS/TRW				
1.9 TDi	66.81	08/96 → 08/99				FCP541	LUCAS/TRW	
2.0 i	88	05/93 → 08/99	FCP774	LUCAS/TRW				
2.0 i	88	05/93 → 08/99	FCP1312	LUCAS/TRW				
2.0 i	88	05/93 → 08/99				FCP541	LUCAS/TRW	
2.0 i 16V	110	08/96 → 08/99	FCP775	LUCAS/TRW				

Ibiza (III)

1.4 i	44	08/99 → 02/02	FCP1288	ATE				
1.4 i 16V	74	08/99 → 02/02	FCP1312	LUCAS/TRW				
1.4 i 16V	74	08/99 → 02/02	FCP1288	ATE				
1.6 i	55	08/99 → 02/02	FCP1288	ATE				
1.6 i	74	08/99 → 02/02	FCP1288	ATE				
1.6 i	74	08/99 → 02/02	FCP1312	LUCAS/TRW				
1.9 SDi	50	08/99 → 02/02	FCP1288	ATE				
1.9 TDi	66	08/99 → 02/02	FCP1288	ATE				
1.9 TDi	66	08/99 → 02/02	FCP1312	LUCAS/TRW				
1.9 TDi	81	08/99 → 02/02	FCP1312	LUCAS/TRW				

IBIZA I (021A)

1.5	63	11/84 → 05/93	FCP351	BENDIX				
1.5 i	65	10/86 → 05/93	FCP351	BENDIX				
1.5 i	74	10/86 → 05/93	FCP351	BENDIX				
1.5 i Cat	66	10/86 → 05/93	FCP351	BENDIX				

For material availability see page 16-18 / Per la disponibilità materiali vedere a pagina 16-18

SEAT



KW

**...SEAT****Ibiza IV (6L1)**

					NOTE			NOTE
1.2 i	47	02/02 → 06/06	FCP1419	LUCAS/TRW				
1.2 i	47	02/02 → 06/06				FCP1491	LUCAS/TRW	
1.4 i 16V	55	02/02 → 12/07	FCP1419	LUCAS/TRW				
1.4 i 16V	55	02/02 → 12/07				FCP1491	LUCAS/TRW	
1.4 TDi	55	05/02 → 12/05	FCP1419	LUCAS/TRW				
1.4 TDi	55	05/02 → 12/05				FCP1491	LUCAS/TRW	
1.8 T Cupra R	132	01/04 → 02/08	FRP3083	AP RACING				
1.8 T Cupra R	132	01/04 → 02/08	FCP590	ATE				
1.8 T Cupra R	132	01/04 → 02/08				FCP1491	LUCAS/TRW	
1.8 T FR	110	12/03 → 05/08	FCP1419	LUCAS/TRW				
1.8 T FR	110	12/03 → 05/08				FCP1491	LUCAS/TRW	
1.9 SDi	47	02/02 → 12/05	FCP1419	LUCAS/TRW				
1.9 SDi	47	02/02 → 12/05				FCP1491	LUCAS/TRW	
1.9 TDi	96	02/02 → 09/11	FCP1419	LUCAS/TRW				
1.9 TDi	96	02/02 → 09/11				FCP1491	LUCAS/TRW	
1.9 TDi Cupra R	118	03/04 → 02/08	FCP590	ATE				
1.9 TDi Cupra R	118	03/04 → 02/08	FRP3083	AP RACING				
1.9 TDi Cupra R	118	03/04 → 02/08				FCP1491	LUCAS/TRW	

Ibiza V Sportcoupe (6J1)

1.4 TSI Cupra	132	06/09 →	FCP1094	ATE	PR: 1LQ,1LR,1ZG			
1.4 TSI Cupra	132	06/09 →				FCP1491	LUCAS/TRW	PR: 1KK,1KT

Ibiza V Sportcoupe (6J1,6P1)

1.2 TSI	77	09/10 →	FCP1094	ATE	PR 1LQ ,1LR			
1.2 TSI	77	09/10 →	FCP1419	LUCAS/TRW				
1.2 TSI	77	09/10 →				FCP1491	LUCAS/TRW	

Ibiza V Sportcoupe (6J1,6P5)

1.8 TSI Cupra	141	11/15 →	FCP1094	ATE	For PR number 1ZG			
1.8 TSI Cupra	141	11/15 →	FCP1641	ATE	For PR Number 1ZC,1ZR,1ZS			
1.8 TSI Cupra	141	11/15 →				FCP1491	LUCAS/TRW	

Inca

1.4	44	01/95 → 03/96	FCP419	KELGATE				
1.4	44	01/95 → 03/96	FCP775	LUCAS/TRW				
1.4	44	04/96 →	FCP774	LUCAS/TRW				
1.6	55	01/95 → 03/96	FCP419	KELGATE				
1.6	55	01/95 → 03/96	FCP775	LUCAS/TRW				
1.6	55	04/96 →	FCP774	LUCAS/TRW				
1.7	42	01/95 → 03/96	FCP419	KELGATE				
1.7	42	01/95 → 03/96	FCP775	LUCAS/TRW				
1.7	42	04/96 →	FCP774	LUCAS/TRW				
1.9 SDi	47	01/95 → 03/96	FCP419	KELGATE				
1.9 SDi	47	01/95 → 03/96	FCP775	LUCAS/TRW				
1.9 SDi	47	04/96 →	FCP774	LUCAS/TRW				

Leon (1M1)

1.4 16V	55	11/99 →	FCP1094	ATE				
1.4 16V	55	11/99 →				FCP1491	LUCAS/TRW	
1.6	74	11/99 →	FCP1094	ATE				
1.6	74	11/99 →				FCP1491	LUCAS/TRW	
1.6	77	11/99 →	FCP1094	ATE				
1.6	77	11/99 →				FCP1491	LUCAS/TRW	
1.6 16V	77	09/00 →	FCP1094	ATE				
1.6 16V	77	09/00 →				FCP1491	LUCAS/TRW	
1.8 20V	92	11/99 →	FCP1094	BREMBO				
1.8 20V	92	11/99 →				FCP1491	LUCAS/TRW	
1.8 20V T, 1.8 20V T 4	132	11/99 →	FCP590	ATE				
1.8 20V T, 1.8 20V T 4	132	11/99 →				FCP1491	LUCAS/TRW	
1.8 T Cupra R	154	11/99 →	FCP590	ATE				
1.8 T Cupra R	154	11/99 →				FCP1491	LUCAS/TRW	
1.8T Cupra R	165	07/03 →	FCP590	ATE				
1.8T Cupra R	165	07/03 →	FCP1348	BREMBO				
1.8T Cupra R	165	07/03 →				FCP1491	LUCAS/TRW	
1.9 SDi	50	11/99 →	FCP1094	ATE				
1.9 SDi	50	11/99 →				FCP1491	LUCAS/TRW	
1.9 Tdi	110	02/01 →	FCP590	ATE				
1.9 Tdi	110	02/01 →				FCP1491	LUCAS/TRW	
1.9 TDi	66	11/99 →	FCP1094	ATE				
1.9 TDi	66	11/99 →				FCP1491	LUCAS/TRW	
1.9 TDi	74	10/05 →	FCP1094	ATE				
1.9 TDi	74	10/05 →				FCP1491	LUCAS/TRW	
1.9 TDi	81	11/99 →	FCP1094	ATE				
1.9 TDi	81	11/99 →				FCP1491	LUCAS/TRW	
1.9 TDi	96	05/03 →	FCP1094	ATE	PR 1LQ/1LR/1LS			

For material availability see page 16-18 / Per la disponibilità materiali vedere a pagina 16-18

1200

FERODO

RACING

Updated on 17th Aug 2018

SEAT



KW



...SEAT

...Leon (1M1)

				NOTE			NOTE
1.9 TDi	96	05/03 →	FCP590	ATE	PR 1LE/1LN/1ZE		
1.9 TDi	96	05/03 →				FCP1491	LUCAS/TRW
1.9 TDi Syncro	110	02/01 →	FCP1348	BREMBO			
1.9 TDi Syncro	110	02/01 →				FCP1491	LUCAS/TRW
2.8 Cupra 4	150	02/01 →	FCP590	ATE	Ch. Y000001 ->		
2.8 Cupra 4	150	02/01 →				FCP1491	LUCAS/TRW

Leon (1P1)

1.4 16V	55	09/05 →	FCP1094	ATE			
1.4 16V	55	09/05 →				FCP1491	LUCAS/TRW
1.4 16V	63	09/05 →	FCP1094	ATE			
1.4 16V	63	09/05 →				FCP1491	LUCAS/TRW
1.4 TSi	92	11/07 →	FCP1094	ATE	PR 1ZF, 1ZM		
1.4 TSi	92	11/07 →	FCP1641	ATE	PR 1LJ, 1ZE		
1.4 TSi	92	11/07 →				FCP1491	LUCAS/TRW
1.6, 1.6 16V	75	09/05 →	FCP1094	ATE			
1.6, 1.6 16V	75	09/05 →				FCP1491	LUCAS/TRW
1.6, 1.6 16V	77	09/05 →	FCP1094	ATE			
1.6, 1.6 16V	77	09/05 →				FCP1491	LUCAS/TRW
1.8 T 20V	132	09/05 →	FCP1641	ATE			
1.8 T 20V	132	09/05 →				FCP1491	LUCAS/TRW
1.8 T 20V	165	09/05 →	FCP1348	BREMBO			
1.8 T 20V	165	09/05 →				FCP1491	LUCAS/TRW
1.8 TSi	118	06/07 →	FCP1641	ATE			
1.8 TSi	118	06/07 →				FCP1491	LUCAS/TRW
1.9 TDi	66	09/05 →	FCP1094	ATE			
1.9 TDi	66	09/05 →				FCP1491	LUCAS/TRW
1.9 TDi	77	09/05 →	FCP1094	ATE			
1.9 TDi	77	09/05 →				FCP1491	LUCAS/TRW
2.0 Cupra R	195	09/09 →	FCP1641	ATE	PR Number 1LJ, 1ZA, 1ZE		
2.0 Cupra R	195	09/09 →	FCP1765	ATE	PR Number: 1LT, 1LU		
2.0 Cupra R	195	09/09 → 12/12	FCP4223	ATE			
2.0 Cupra R	195	09/09 → 12/12				FCP1636	LUCAS/TRW Disc Diam mm:286,For PR code:1KZ/1KY
2.0 Cupra R	195	09/09 →				FCP4316	BOSCH PR Numbers: 1KS
2.0 Cupra R	195	09/09 →				FCP1491	LUCAS/TRW PR Number: 1KD
2.0 FSi	110	09/05 →	FCP1641	ATE			
2.0 FSi	110	09/05 →				FCP1491	LUCAS/TRW
2.0 FSi 16v	110	07/05 → 05/10	FCP1641	ATE	PR 1ZA, 1LJ,1ZE		
2.0 FSi 16v	110	07/05 → 05/10				FCP4316	BOSCH
2.0 TDi	100	09/05 →	FCP1641	ATE			
2.0 TDi	100	09/05 →				FCP1491	LUCAS/TRW
2.0 TDi	103	09/05 →	FCP1641	ATE			
2.0 TDi	103	09/05 →				FCP1491	LUCAS/TRW
2.0 TDi	125	02/06 →	FCP1641	ATE			
2.0 TDi	125	02/06 →				FCP1491	LUCAS/TRW
2.0 TDi 16v	125	05/06 → 10/10	FCP1641	ATE	PR 1LJ/1ZA, 1ZE		
2.0 TDi 16v	125	05/06 → 10/10				FCP4316	BOSCH
2.0 TFSI	177	11/06 → 05/11	FCP4223	ATE			
2.0 TFSI	177	11/06 → 05/11	FCP1765	ATE	Disc Diam mm:345,For PR code:1LU		
2.0 TFSI	177	11/06 → 05/11				FCP1636	LUCAS/TRW Disc Diam mm:286,For PR code:1KZ/1KY
2.0 TFSi	136	09/05 →	FCP1765	ATE			
2.0 TFSi	136	09/05 →				FCP1491	LUCAS/TRW
2.0 TFSi	147	09/05 →	FCP1765	ATE			
2.0 TFSi	147	09/05 →				FCP1491	LUCAS/TRW
2.0 TFSi	177	11/06 →	FCP1765	ATE			
2.0 TFSi	177	11/06 →				FCP1491	LUCAS/TRW
2.0 TFSi 16v	136	10/05 → 05/06	FCP1765	ATE	PR 1LU		
2.0 TFSi 16v	136	10/05 → 05/06	FCP1641	ATE	PR 1LJ/1ZA, 1ZE		
2.0 TFSi 16v	136	10/05 → 05/06				FCP4316	BOSCH
2.0 TSFI	136	09/05 →	FCP1641	ATE			
2.0 TSFI	136	09/05 →				FCP1491	LUCAS/TRW
2.0 TSFI	147	09/05 →	FCP1641	ATE			
2.0 TSFI	147	09/05 →				FCP1491	LUCAS/TRW
2.0 TSi 16v	147	05/05 → 03/09	FCP1765	ATE	PR 1LU		
2.0 TSi 16v	147	05/05 → 03/09	FCP1641	ATE	PR 1LJ, 1ZE		
2.0 TSi 16v	147	05/05 → 03/09				FCP4316	BOSCH

LEON (5F1)

1.0 TSi	85	05/15 →				FCP4434	ATE
1.2 TSi	63	01/13 →	FCP4433	LUCAS/TRW			
1.2 TSi	77	01/13 →	FCP4433	LUCAS/TRW			
1.4 TSi	103	09/12 →	FCP4433	LUCAS/TRW			
1.4 TSi	110	05/14 →	FCP4433	TRW	Disc Diam mm:288,For PR code:1ZE		
1.4 TSi	110	05/14 →				FCP4434	ATE
1.4 TSi	90	11/12 →	FCP4433	LUCAS/TRW			
1.6 TDi	66	11/12 →	FCP4433	LUCAS/TRW			
1.6 TDi	77	11/12 →	FCP4433	LUCAS/TRW			

For material availability see page 16-18 / Per la disponibilità materiali vedere a pagina 16-18

SEAT



KW



...SEAT

...LEON (5F1)

					NOTE			NOTE
1.6 TDI	85	11/16 →	FCP4433	TRW	Disc Diam mm:288,For PR code:1ZE			
1.6 TDI	85	11/16 →				FCP4434	ATE	Disc Diam mm:272,For PR code:1KE
1.8 TSI	132	02/13 →	FCP4433	LUCAS/TRW				
2.0 Cupra	206	10/13 →	FCP4425	LUCAS/TRW	PR 1LJ			
2.0 Cupra	206	10/13 →				FCP1636	LUCAS/TRW	PR 1KW
2.0 TDI	105	05/13 →	FCP4433	TRW	Disc Diam mm:288,For PR code:1ZE			
2.0 TDI	105	05/13 →				FCP4434	ATE	
2.0 TDI	110	10/12 →	FCP4433	LUCAS/TRW				
2.0 TDI	110	10/12 →				FCP4434	ATE	
2.0 TDI	135	09/12 →	FCP4433	LUCAS/TRW				
2.0 TDI	135	09/12 →				FCP4434	ATE	
2.0 TDI	81	05/13 →	FCP4433	TRW	Disc Diam mm:288,For PR code:1ZE			
2.0 TDI	81	05/13 →				FCP4434	ATE	

Leon (MK1)

2.0 SuperCopa		01/99 → 12/05	FRP3084	AP RACING				
2.0 SuperCopa		01/99 → 12/05				FCP541	AP RACING	

Leon (MK2)

2.0 SuperCopa	220	01/05 → 12/12	FRP3084	AP RACING				
2.0 SuperCopa	220	01/05 → 12/12				FCP541	AP RACING	

Leon (MK3)

2.0 SuperCopa		01/12 →	FRP3014	AP RACING				
2.0 SuperCopa		01/12 →				FCP541	AP RACING	

LEON SC (5F5)

1.0 TSI	85	05/15 →				FCP4434	ATE	
1.4 TSI	110	05/14 →	FCP4433	TRW	Disc Diam mm:288,For PR code:1ZE			
1.4 TSI	110	05/14 →				FCP4434	ATE	
1.6 TDI	85	11/16 →	FCP4433	TRW	Disc Diam mm:288,For PR code:1ZE			Disc Diam mm:272,For PR code:1KE
1.6 TDI	85	11/16 →				FCP4434	ATE	
1.8 TSI	132	02/13 →	FCP4433	LUCAS/TRW				
2.0 Cupra	206	10/13 →	FCP4425	LUCAS/TRW	PR 1LJ			
2.0 Cupra	206	10/13 →				FCP1636	LUCAS/TRW	PR 1KW
2.0 Cupra	213	10/15 →	FCP4425	LUCAS/TRW	PR 1LJ,1LG,1LD			
2.0 Cupra	213	10/15 →				FCP1636	LUCAS/TRW	PR 1KW, 1KF
2.0 TDI	105	05/13 →	FCP4433	TRW	Disc Diam mm:288,For PR code:1ZE			
2.0 TDI	105	05/13 →				FCP4434	ATE	
2.0 TDI	110	02/13 →	FCP4433	TRW	Disc Diam mm:288,For PR code:1ZE			
2.0 TDI	110	02/13 →				FCP4434	ATE	
2.0 TDI	135	03/13 →	FCP4433	TRW	Disc Diam mm:288,For PR code:1ZE			
2.0 TDI	135	03/13 →				FCP4434	ATE	
2.0 TDI	81	02/13 →	FCP4433	TRW	Disc Diam mm:288,For PR code:1ZE			
2.0 TDI	81	02/13 →				FCP4434	ATE	

LEON ST (5F8)

1.0 TSI	85	05/15 →				FCP4434	ATE	
1.2 TSI	63	11/13 →	FCP4433	LUCAS/TRW	PR 1LJ			
1.2 TSI	63	11/13 →				FCP1491	LUCAS/TRW	PR Number 1KD
1.2 TSI	63	11/13 →				FCP1636	LUCAS/TRW	PR Number 1KS
1.2 TSI	77	08/13 →	FCP4433	LUCAS/TRW	PR 1LJ			
1.2 TSI	77	08/13 →				FCP1491	LUCAS/TRW	PR Number 1KD
1.2 TSI	77	08/13 →				FCP1636	LUCAS/TRW	PR Number 1KS
1.4 TGI	81	10/13 →	FCP4433	LUCAS/TRW	PR 1LJ			
1.4 TGI	81	10/13 →				FCP1491	LUCAS/TRW	PR Number 1KD
1.4 TGI	81	10/13 →				FCP1636	LUCAS/TRW	PR Number 1KS
1.4 TSI	103	10/13 →	FCP4433	LUCAS/TRW	PR 1 LJ			
1.4 TSI	103	10/13 →				FCP1491	LUCAS/TRW	PR Number 1KD
1.4 TSI	103	10/13 →				FCP1636	LUCAS/TRW	PR Number 1KS
1.4 TSI	110	05/14 →	FCP4433	TRW	Disc Diam mm:312,For PR code:1ZA			
1.4 TSI	110	05/14 →				FCP4434	ATE	
1.4 TSI	90	10/13 →	FCP4433	LUCAS/TRW	PR 1LJ			
1.4 TSI	90	10/13 →				FCP1491	LUCAS/TRW	PR Number 1KD
1.4 TSI	90	10/13 →				FCP1636	LUCAS/TRW	PR Number 1KS
1.6 TDI	66	11/13 →	FCP4433	LUCAS/TRW	PR 1LJ			
1.6 TDI	66	11/13 →				FCP1491	LUCAS/TRW	PR Number 1KD
1.6 TDI	66	11/13 →				FCP1636	LUCAS/TRW	PR Number 1KS
1.6 TDI	77	10/13 →	FCP4433	LUCAS/TRW	PR 1LJ			
1.6 TDI	77	10/13 →				FCP1491	LUCAS/TRW	PR Number 1KD
1.6 TDI	77	10/13 →				FCP1636	LUCAS/TRW	PR Number 1KS
1.6 TDI	81	09/13 →	FCP4433	LUCAS/TRW	PR 1LJ			
1.6 TDI	81	09/13 →				FCP1491	LUCAS/TRW	PR Number 1KD
1.6 TDI	81	09/13 →				FCP1636	LUCAS/TRW	PR Number 1KS
1.6 TDI	85	11/16 →	FCP4433	TRW	Disc Diam mm:288,For PR code:1ZE			
1.6 TDI	85	11/16 →				FCP4434	ATE	Disc Diam mm:272,For PR code:1KE

For material availability see page 16-18 / Per la disponibilità materiali vedere a pagina 16-18

1202

FERODO

RACING

Updated on 17th Aug 2018



KW



...SEAT

...LEON ST (5F8)

			NOTE			NOTE		
1.6 TDI 4Drive	77	04/14 →	FCP4433	LUCAS/TRW	PR 1LJ	FCP1491	LUCAS/TRW	PR Number 1KD
1.6 TDI 4Drive	77	04/14 →				FCP1636	LUCAS/TRW	PR Number 1KS
1.6 TDI 4Drive	77	04/14 →						
1.8 TFSI	132	10/13 →	FCP4433	LUCAS/TRW	PR 1LJ	FCP1491	LUCAS/TRW	PR Number 1KD
1.8 TFSI	132	10/13 →				FCP1636	LUCAS/TRW	PR Number 1KS
1.8 TFSI	132	10/13 →						
2.0 Cupra	206	10/13 →	FCP4433	LUCAS/TRW	PR 1LJ			
2.0 Cupra	206	10/13 →	FCP4433	LUCAS/TRW	PR 1LJ			
2.0 Cupra	206	10/13 →				FCP1636	LUCAS/TRW	PR 1KW,1KF
2.0 TDI	105	10/13 →	FCP4433	LUCAS/TRW	PR 1LJ			
2.0 TDI	105	10/13 →				FCP1491	LUCAS/TRW	PR Number 1KD
2.0 TDI	105	10/13 →				FCP1636	LUCAS/TRW	PR Number 1KS
2.0 TDI	105	10/13 →				FCP4434	ATE	
2.0 TDI	110	10/13 →	FCP4433	LUCAS/TRW	PR 1LJ			
2.0 TDI	110	10/13 →				FCP1491	LUCAS/TRW	PR Number 1KD
2.0 TDI	110	10/13 →				FCP1636	LUCAS/TRW	PR Number 1KS
2.0 TDI	110	10/13 →				FCP4434	ATE	
2.0 TDI	135	08/13 →	FCP4433	LUCAS/TRW	PR 1LJ			
2.0 TDI	135	08/13 →				FCP1491	LUCAS/TRW	PR Number 1KD
2.0 TDI	135	08/13 →				FCP1636	LUCAS/TRW	PR Number 1KS
2.0 TDI	135	08/13 →				FCP4434	ATE	
2.0 TDI	81	11/13 →	FCP4433	LUCAS/TRW	PR 1LJ			
2.0 TDI	81	11/13 →				FCP1491	LUCAS/TRW	PR Number 1KD
2.0 TDI	81	11/13 →				FCP1636	LUCAS/TRW	PR Number 1KS
2.0 TDI	81	11/13 →				FCP4434	ATE	
2.0 TDI 4Drive	135	11/14 →	FCP4433	TRW	For PR code:1ZE			
2.0 TDI 4Drive	135	11/14 →				FCP4434	ATE	

Malaga

0.8	25	01/87 → 12/93	FCP351	BENDIX				
0.9	29, 30	01/87 →	FCP351	BENDIX				
1.2	45	05/85 → 04/91	FCP351	BENDIX				
1.2	46	05/85 → 04/91	FCP351	BENDIX				
1.2	52	05/85 → 04/91	FCP351	BENDIX				
1.5	64	05/85 → 04/91	FCP351	BENDIX				
1.5 i	73	01/87 → 04/91	FCP351	BENDIX				
1.7 D	41	01/87 → 04/91	FCP351	BENDIX				

Marbella

0.8	25	11/86 → 09/89	FCP351	BENDIX				
0.9	29, 30	11/86 → 05/89	FCP351	BENDIX				
1.3	33	11/86 → 09/91	FCP351	BENDIX				

Panda

0.9	31	01/79 → 12/82	FCP29	BENDIX				
-----	----	---------------	-------	--------	--	--	--	--

Ritmo

1.2	46	01/78 → 12/88	FCP29	BENDIX				
1.4	55	01/78 → 12/88	FCP29	BENDIX				

Ronda

1.2	45, 46	06/82 → 12/87	FCP351	BENDIX				
1.4	54	06/82 → 11/88	FCP351	BENDIX				
1.5	66	08/83 → 12/87	FCP351	BENDIX				
1.6	68	06/82 → 12/87	FCP351	BENDIX				
1.7	41	06/82 → 12/87	FCP351	BENDIX				

Terra

0.9	29	01/84 →	FCP351	BENDIX				
1.3	33	03/90 → 12/94	FCP351	BENDIX				
1.4	35	01/84 →	FCP351	BENDIX				

Toledo

1.6	55	04/91 → 10/98	FCP419	KELGATE				
1.6	74	11/98 →	FCP1289	LUCAS/TRW				
1.6	74	11/98 →				FCP541	LUCAS/TRW	
1.8	66	04/91 → 10/98	FCP419	KELGATE				
1.8	92	11/98 →	FCP1289	LUCAS/TRW				
1.8	92	11/98 →				FCP541	LUCAS/TRW	
1.8 16V	95, 102	04/91 → 03/99	FCP774	LUCAS/TRW				
1.8 16V	95, 102	04/91 → 03/99				FCP541	LUCAS/TRW	
1.9 TD	55	01/91 →	FCP419	KELGATE				
1.9 TDi	66, 81	08/95 → 10/98	FCP775	LUCAS/TRW				
1.9 TDi	66, 81	08/95 → 10/98	FCP774	LUCAS/TRW				
1.9 TDi	66, 81	11/98 →	FCP1289	LUCAS/TRW				
1.9 TDi	66, 81	11/98 →				FCP541	LUCAS/TRW	

For material availability see page 16-18 / Per la disponibilità materiali vedere a pagina 16-18

SEAT



KW

**...SEAT****...Toledo**

					NOTE		NOTE
2.0	85	04/91 → 10/98	FCP774	LUCAS/TRW			
2.0	85	04/91 → 10/98				FCP541	LUCAS/TRW
2.0 GT 16V	110	01/94 → 10/98	FCP774	LUCAS/TRW			
2.0 GT 16V	110	01/94 → 10/98				FCP541	LUCAS/TRW
2.3 V5	110	11/98 →	FCP590	ATE			
2.3 V5	110	11/98 →				FCP541	LUCAS/TRW

Toledo (I)

1.6 i	55	04/91 → 03/99	FCP419	KELGATE			
1.6 i	55	04/91 → 03/99	FCP1054	ATE			
1.6 i	55	04/91 → 03/99	FCP1288	ATE			
1.8 i	66	04/91 → 12/96	FCP419	KELGATE			
1.8 i	66	04/91 → 12/96	FCP1054	ATE			
1.8 i	66	04/91 → 12/96	FCP1288	ATE			
1.8 i 16V	92, 98	05/91 → 03/99	FCP1312	LUCAS/TRW			
1.9 D, TD, SDi	47	05/91 → 03/99	FCP1288	ATE			
1.9 D, TD, SDi	47	05/91 → 03/99	FCP1054	ATE			
1.9 D, TD, SDi	47	05/91 → 03/99	FCP419	KELGATE			
1.9 D, TD, SDi	50	05/91 → 03/99	FCP1288	ATE			
1.9 D, TD, SDi	50	05/91 → 03/99	FCP1054	ATE			
1.9 D, TD, SDi	50	05/91 → 03/99	FCP419	KELGATE			
1.9 D, TD, SDi	55	05/91 → 03/99	FCP1288	ATE			
1.9 D, TD, SDi	55	05/91 → 03/99	FCP1054	ATE			
1.9 D, TD, SDi	55	05/91 → 03/99	FCP419	KELGATE			
1.9 TDi	66.81	08/95 → 03/99	FCP1312	LUCAS/TRW			
1.9 TDi	66.81	08/95 → 03/99	FCP774	LUCAS/TRW			
1.9 TDi	66.81	08/95 → 03/99	FCP775	LUCAS/TRW			
2.0 i	85	04/91 → 10/98	FCP774	LUCAS/TRW			
2.0 i	85	04/91 → 10/98	FCP1312	LUCAS/TRW			
2.0 i	85	04/91 → 10/98				FCP541	LUCAS/TRW

Toledo (II)

1.8 i		04/99 →	FCP590	ATE			
1.8 i		04/99 →				FCP541	LUCAS/TRW
2.3 i V5		04/99 →	FCP590	ATE			
2.3 i V5		04/99 →				FCP541	LUCAS/TRW

Toledo (III)

1.6 i	75	12/04 →	FCP1094	ATE			
1.9 TDi	77	10/04 →	FCP1641	ATE			
1.9 TDi	77	12/04 →	FCP1094	ATE			
2.0 Tdi 16V	103	12/04 →	FCP1641	ATE			
2.0 Tdi 16V	103	12/04 →				FCP1636	LUCAS/TRW

Toledo I (1L)

1.9 D	47	12/95 → 03/99	FCP1054	ATE			
1.9 D	50	05/91 → 03/99	FCP1054	ATE			
1.9 D	50	05/91 → 03/99	FCP419	KELGATE			
1.9 TD	55	05/91 → 03/99	FCP1054	ATE			
1.9 TD	55	05/91 → 03/99	FCP419	KELGATE			

Toledo III (5P2)

2.0 FSi	110	12/04 →	FCP1641	ATE			
2.0 FSi	110	12/04 →				FCP1636	LUCAS/TRW

SINGER**Gazelle**01/64 → 12/65 **FCP823** LOCKHEED**Vogue**01/61 → 12/67 **FCP823** LOCKHEED

For material availability see page 16-18 / Per la disponibilità materiali vedere a pagina 16-18

1204**FERODO®**

RACING

Updated on 17th Aug 2018

SEAT



KW

**SKODA****130 (Estelle)**

1.3 Rapide Coupe 46 01/85 → 12/90

FCP461 ATE

NOTE

NOTE

135 (Estelle)

1.3 01/85 → 12/90

FCP461 ATE

Fabia

1.0 37 07/00 →

FCP1101 ATE

1.2 40 07/00 →

FCP1094 ATE

1.4 50 10/99 → 07/03

FCP1094 ATE

1.4 16V 55, 74 10/99 →

FCP1094 ATE

1.4 16V 55, 74 10/99 →

FCP1094 ATE

1.4 TDi PD 16V 55 08/03 →

FCP1094 ATE

1.9 SDi 47 01/00 →

FCP1094 ATE

1.9 TDi 74 01/00 →

FCP1094 ATE

1.9 TDi 74 01/00 →

FCP1094 ATE

1.9 TDi RS 96 07/03 →

FCP1419 LUCAS/TRW

2.0 i 88 08/03 →

FCP1419 LUCAS/TRW

2.0 i 88 08/03 →

FCP1491 LUCAS/TRW

2.0 Saloon & SW Estate 85 08/00 →

FCP1419 LUCAS/TRW

2.0 Saloon & SW Estate 85 08/00 →

FCP1419 LUCAS/TRW

Octavia

1.4 EU4 55 08/00 → 05/04

FCP1094 ATE

1.4 i 44 04/99 → 05/04

FCP1094 ATE

1.4 i 16V 55 12/99 → 07/00

FCP1094 ATE

1.4 TSi 16v (1Z3,1Z5) 90 11/08 →

FCP1094 ATE

1.4 TSi 16v (1Z3,1Z5) 90 11/08 →

FCP1094 ATE

1.6 8v (1Z3,1Z5) 75 05/04 →

FCP1094 ATE

1.6 8v (1Z3,1Z5) 75 05/04 →

FCP1094 ATE

1.6 EU4 75 08/00 → 05/04

FCP1094 ATE

1.6 FSi 8v (1Z5) 75 09/04 →

FCP1094 ATE

1.6 FSi 8v (1Z5) 75 09/04 →

FCP1094 ATE

1.6 i 55 09/96 → 07/00

FCP1094 ATE

1.6 i 74 02/97 → 05/04

FCP1094 ATE

1.6 Multifuel 8v (1Z3,1Z5) 75 11/07 → 05/10

FCP1094 ATE

1.6 Multifuel 8v (1Z3,1Z5) 75 11/07 → 05/10

FCP1094 ATE

1.6 TDi 16v (1Z5) 77 06/09 →

FCP1094 ATE

1.6 TDi 16v (1Z5) 77 06/09 →

FCP1094 ATE

1.8 20V 10/96 → 04/99

FCP1094 ATE

1.8 20V 10/96 → 04/99

FCP1094 ATE

1.8 FSi/TSi 16v (1Z3,1Z5) 118 06/07 →

FCP1641 ATE

1.8 FSi/TSi 16v (1Z3,1Z5) 118 06/07 →

FCP1641 ATE

1.8 TFSi 16v (1Z3,1Z5) 112 03/09 →

FCP1641 ATE

1.8 TFSi 16v (1Z3,1Z5) 112 03/09 →

FCP1641 ATE

1.8 TSi 16v (1Z5,1Z5) 118 11/08 →

FCP1641 ATE

1.8 TSi 16v (1Z5,1Z5) 118 11/08 →

FCP1641 ATE

1.8 Turbo 20V 01/97 → 07/00

FCP590 ATE

1.8 Turbo 20V 01/97 → 07/00

FCP590 ATE

1.8 Turbo EU3 (4x4), EU4 (RS) 20V 110 08/00 → 05/04

FCP590 ATE

1.8 Turbo EU3 (4x4), EU4 (RS) 20V 110 08/00 → 05/04

FCP590 ATE

1.9 SDi EU3 10/96 → 07/00

FCP1094 ATE

1.9 TDi 66 10/97 → 07/00

FCP1094 ATE

1.9 TDi 81 10/97 → 07/00

FCP1094 ATE

1.9 TDi 4x4 74 10/97 → 07/00

FCP1094 ATE

1.9 TDi (4x4) 77 11/04 → 12/10

FCP1641 ATE

1.9 TDi (4x4) 77 11/04 → 12/10

FCP1641 ATE

1.9 TDi 8v (1Z5) 77 05/04 → 12/10

FCP1094 ATE

1.9 TDi 8v (1Z5) 77 05/04 → 12/10

FCP1094 ATE

1.9 TDi EU3 10/96 → 07/00

FCP1094 ATE

1.9 TDi EU3 (4x4) 74 08/00 → 05/04

FCP1094 ATE

1.9 TDi EU3 (4x4) 74 08/00 → 05/04

FCP1094 ATE

2.0 (4x4) 85 08/00 → 05/04

FCP1094 ATE

2.0 (4x4) 85 08/00 → 05/04

FCP1094 ATE

2.0 16v (1Z3,1Z5) 100 02/04 → 05/10

FCP1641 ATE

2.0 16v (1Z3,1Z5) 100 02/04 → 05/10

FCP1641 ATE

2.0 EU4 85 08/00 → 05/04

FCP1094 ATE

2.0 EU4 85 08/00 → 05/04

FCP1094 ATE

2.0 i 85 10/96 → 07/00

FCP1094 ATE

2.0 TDi 16v (1Z3, 1Z5) 125 04/06 →

FCP1641 ATE

2.0 TDi 16v (1Z3, 1Z5) 125 04/06 →

FCP1641 ATE

2.0 TDi 16v (1Z3,1Z5) 103 02/04 →

FCP1641 ATE

2.0 TDi 16v (1Z3,1Z5) 103 02/04 →

FCP1641 ATE

2.0 TDi 16v (1Z3,1Z5) 81 03/10 →

FCP1641 ATE

2.0 TDi 16v (1Z3,1Z5) 81 03/10 →

FCP1641 ATE

2.0 TDi 8v (1Z3,1Z5) 103 11/05 → 05/10

FCP1641 ATE

2.0 TDi 8v (1Z3,1Z5) 103 11/05 → 05/10

FCP1641 ATE

2.0 TFSi/TSi 16v (1Z3,1Z5) 147 10/05 →

FCP1641 ATE

For material availability see page 16-18 / Per la disponibilità materiali vedere a pagina 16-18



KW



...SKODA

...Octavia

2.0 TFSi/TSi 16v (1Z3,1Z5) 147 10/05 →

FCP4316 BOSCH

Octavia (5E3)

Model	Power	Year	Code	Brand	Note	Code	Brand	Note
1.2 TSI	63	11/12 →	FCP4425	LUCAS/TRW	PR 1LG (340mm disc)			
1.2 TSI	63	11/12 →				FCP1491	LUCAS/TRW	PR Number: 1KD
1.2 TSI	77	11/12 →	FCP4425	LUCAS/TRW	PR 1LG (340mm disc)			
1.2 TSI	77	11/12 →				FCP1491	LUCAS/TRW	PR Number: 1KD
1.4 TSI	103	11/12 →	FCP4425	LUCAS/TRW	PR 1LG (340mm disc)			
1.4 TSI	103	11/12 →				FCP1491	LUCAS/TRW	PR Number: 1KD
1.6 TDI	66	11/12 →	FCP4425	LUCAS/TRW	PR 1LG (340mm disc)			
1.6 TDI	66	11/12 →				FCP1491	LUCAS/TRW	PR Number: 1KD
1.6 TDI	77	11/12 →	FCP4425	LUCAS/TRW	PR 1LG (340mm disc)			
1.6 TDI	77	11/12 →				FCP1491	LUCAS/TRW	PR Number: 1KD
1.8 TSI	132	11/12 →	FCP4425	LUCAS/TRW	PR 1LG (340mm disc)			
1.8 TSI	132	11/12 →				FCP1491	LUCAS/TRW	PR Number: 1KD
2.0 TDI	105	11/12 →	FCP4425	LUCAS/TRW	PR 1LG (340mm disc)			
2.0 TDI	105	11/12 →				FCP1491	LUCAS/TRW	PR Number: 1KD
2.0 TDI	110	11/12 →	FCP4425	LUCAS/TRW	PR 1LG (340mm disc)			
2.0 TDI	110	11/12 →				FCP1491	LUCAS/TRW	PR Number: 1KD
2.0 TDI RS	135	05/13 →	FCP4425	LUCAS/TRW	PR 1LG (340mm disc)			
2.0 TDI RS	135	05/13 →				FCP1491	LUCAS/TRW	PR Number: 1KD
2.0 TSI RS	162	05/13 →	FCP4425	LUCAS/TRW	PR 1LG (340mm disc)			
2.0 TSI RS	162	05/13 →				FCP1491	LUCAS/TRW	PR Number: 1KD

Octavia Combi (5E5)

1.2 TSI	63	11/12 →	FCP4425	LUCAS/TRW	PR 1LG (340mm disc)			
1.2 TSI	63	11/12 →				FCP1491	LUCAS/TRW	PR Number: 1KD
1.2 TSI	77	11/12 →	FCP4425	LUCAS/TRW	PR 1LG (340mm disc)			
1.2 TSI	77	11/12 →				FCP1491	LUCAS/TRW	PR Number: 1KD
1.4 TSI	103	11/12 →	FCP4425	LUCAS/TRW	PR 1LG (340mm disc)			
1.4 TSI	103	11/12 →				FCP1491	LUCAS/TRW	PR Number: 1KD
1.6 TDI	66	11/12 →	FCP4425	LUCAS/TRW	PR 1LG (340mm disc)			
1.6 TDI	66	11/12 →				FCP1491	LUCAS/TRW	PR Number: 1KD
1.6 TDI	77	11/12 →	FCP4425	LUCAS/TRW	PR 1LG (340mm disc)			
1.6 TDI	77	11/12 →				FCP1491	LUCAS/TRW	PR Number: 1KD
1.6 TDI 4x4	77	11/12 →	FCP4425	LUCAS/TRW	PR 1LG (340mm disc)			
1.6 TDI 4x4	77	11/12 →				FCP1491	LUCAS/TRW	PR Number: 1KD
1.8 TSI	132	11/12 →	FCP4425	LUCAS/TRW	PR 1LG (340mm disc)			
1.8 TSI	132	11/12 →				FCP1491	LUCAS/TRW	PR Number: 1KD
1.8 TSI 4x4	132	11/12 →	FCP4425	LUCAS/TRW	PR 1LG (340mm disc)			
1.8 TSI 4x4	132	11/12 →				FCP1491	LUCAS/TRW	PR Number: 1KD
2.0 TDI	105	11/12 →	FCP4425	LUCAS/TRW	PR 1LG (340mm disc)			
2.0 TDI	105	11/12 →				FCP1491	LUCAS/TRW	PR Number: 1KD
2.0 TDI	110	11/12 →	FCP4425	LUCAS/TRW	PR 1LG (340mm disc)			
2.0 TDI	110	11/12 →				FCP1491	LUCAS/TRW	PR Number: 1KD
2.0 TDI 4x4	110	11/12 →	FCP4425	LUCAS/TRW	PR 1LG (340mm disc)			
2.0 TDI 4x4	110	11/12 →				FCP1491	LUCAS/TRW	PR Number: 1KD
2.0 TDI RS	135	05/13 →	FCP4425	LUCAS/TRW	PR 1LG (340mm disc)			
2.0 TDI RS	135	05/13 →				FCP1491	LUCAS/TRW	PR Number: 1KD
2.0 TSI RS	162	11/12 →	FCP4425	LUCAS/TRW	PR 1LG (340mm disc)			
2.0 TSI RS	162	11/12 →				FCP1491	LUCAS/TRW	PR Number: 1KD

Octavia II

1.4	59	06/04 →				FCP1636	LUCAS/TRW	
1.6		06/04 →				FCP1636	LUCAS/TRW	
1.6 FSi	85	06/04 →				FCP1636	LUCAS/TRW	
1.9 TDi		06/04 →				FCP1636	LUCAS/TRW	
1.9 TDi	77	06/04 →				FCP1636	LUCAS/TRW	
2.0 FSi	110	06/04 →	FCP1641	ATE				
2.0 FSi	110	06/04 →				FCP1636	LUCAS/TRW	
2.0 i	110	06/04 →	FCP1641	ATE				
2.0 i	110	06/04 →				FCP1636	LUCAS/TRW	
2.0 TDi	103	06/04 →	FCP1641	ATE				
2.0 TDi	103	06/04 →				FCP1636	LUCAS/TRW	

Octavia Scout

1.8 TFSi 16v (4x4)	112	03/09 →	FCP1641	ATE	PR 1ZE			
1.8 TFSi 16v (4x4)	112	03/09 →				FCP4316	BOSCH	
1.8 TSi 16v (4x4)	118	11/08 →	FCP1641	ATE	PR 1ZE			
1.8 TSi 16v (4x4)	118	11/08 →				FCP4316	BOSCH	
2.0 TDi 8v (1Z5)	103	10/06 → 05/10	FCP1641	ATE	PR 1ZE			
2.0 TDi 8v (1Z5)	103	10/06 → 05/10				FCP4316	BOSCH	

For material availability see page 16-18 / Per la disponibilità materiali vedere a pagina 16-18

1206

FERODO

RACING

Updated on 17th Aug 2018

SKODA



KW

**...SKODA****Superb**

			NOTE			NOTE		
1.4 TFSi 16v (3T4)	92	08/08 →	FCP1641	ATE	PR 1LJ/1ZA, 1ZE			
1.4 TFSi 16v (3T4)	92	08/08 →				FCP4316	BOSCH	
1.4 TFSi 16v (3T5)	92	08/08 →	FCP1641	ATE	PR 1LJ/1ZA, 1ZE			
1.4 TFSi 16v (3T5)	92	08/08 →				FCP4316	BOSCH	
1.6 TDi 16v (3T4)	77	09/10 →	FCP1641	ATE	PR 1LJ/1ZA			
1.6 TDi 16v (3T4)	77	09/10 →				FCP4316	BOSCH	
1.6 TDi 16v (3T5)	77	09/10 →	FCP1641	ATE	PR 1LJ/1ZA			
1.6 TDi 16v (3T5)	77	09/10 →				FCP4316	BOSCH	
1.8 FSi/TSi 16v (3T4)	118	03/08 →	FCP1641	ATE	PR 1LJ/1ZA, 1ZE			
1.8 FSi/TSi 16v (3T4)	118	03/08 →				FCP4316	BOSCH	
1.8 TFSi 16v (3T4)	112	03/09 →	FCP1641	ATE	PR 1LJ/1ZA/1ZE			
1.8 TFSi 16v (3T4)	112	03/09 →				FCP4316	BOSCH	
1.8 TFSi 16v (3T5)	112	03/09 →	FCP1641	ATE	PR 1LJ/1ZA/1ZE			
1.8 TFSi 16v (3T5)	112	03/09 →				FCP4316	BOSCH	
1.8 TSi 16v (3T5)	118	03/09 →	FCP1641	ATE	PR 1LJ/1ZA/1ZE			
1.8 TSi 16v (3T5)	118	03/09 →				FCP4316	BOSCH	
1.9 TDi 8v (3T4)	77	03/08 →	FCP1641	ATE	PR 1LJ/1ZA/1ZE			
1.9 TDi 8v (3T4)	77	03/08 →				FCP4316	BOSCH	
1.9 TDi 8v (3T5)	77	03/08 →	FCP1641	ATE	PR 1LJ/1ZA/1ZE			
1.9 TDi 8v (3T5)	77	03/08 →				FCP4316	BOSCH	
2.0 TDi 16v (3T4)	103	01/09 →	FCP1641	ATE	PR 1LJ/1ZA/1ZE			
2.0 TDi 16v (3T4)	103	01/09 →				FCP4316	BOSCH	
2.0 TDi 16v (3T4)	125	06/08 →	FCP1641	ATE	PR 1LJ/1ZA/1ZE			
2.0 TDi 16v (3T4)	125	06/08 →				FCP4316	BOSCH	
2.0 TDi 16v (3T5)	103	01/09 →	FCP1641	ATE	PR 1LJ/1ZA/1ZE			
2.0 TDi 16v (3T5)	103	01/09 →				FCP4316	BOSCH	
2.0 TDi 16v (3T5)	125	06/08 →	FCP1641	ATE	PR 1LJ/1ZA/1ZE			
2.0 TDi 16v (3T5)	125	06/08 →				FCP4316	BOSCH	
2.0 TDi 8v (3T4)	103	03/08 → 03/10	FCP1641	ATE	PR 1LJ/1ZA/1ZE			
2.0 TDi 8v (3T4)	103	03/08 → 03/10				FCP4316	BOSCH	
2.0 TDi 8v (3T5)	103	03/08 → 03/10	FCP1641	ATE	PR 1LJ/1ZA/1ZE			
2.0 TDi 8v (3T5)	103	03/08 → 03/10				FCP4316	BOSCH	

Superb (3U4)

1.8 T	110	12/01 → 03/08	FCP1717	ATE				
1.8 T	110	12/01 → 03/08				FCP1491	LUCAS/TRW	PR Number: 1KD
1.9 TDI	74	08/02 → 10/05	FCP1717	ATE				
1.9 TDI	74	08/02 → 10/05				FCP1491	LUCAS/TRW	PR Number: 1KD
1.9 TDI	77	10/05 → 05/07	FCP1717	ATE				
1.9 TDI	77	10/05 → 05/07				FCP1491	LUCAS/TRW	PR Number: 1KD
1.9 TDI	85	01/07 → 03/08	FCP1717	ATE				
1.9 TDI	85	01/07 → 03/08				FCP1491	LUCAS/TRW	PR Number: 1KD
1.9 TDI	96	12/01 → 03/08	FCP1717	ATE				
1.9 TDI	96	12/01 → 03/08				FCP1491	LUCAS/TRW	PR Number: 1KD
2.0	85	12/01 → 03/08	FCP1717	ATE				
2.0	85	12/01 → 03/08				FCP1491	LUCAS/TRW	PR Number: 1KD
2.0 TDI	103	10/05 → 03/08	FCP1717	ATE				
2.0 TDI	103	10/05 → 03/08				FCP1491	LUCAS/TRW	PR Number: 1KD
2.5 TDI	114	12/01 → 08/03	FCP1717	ATE				
2.5 TDI	114	12/01 → 08/03				FCP1491	LUCAS/TRW	PR Number: 1KD
2.5 TDI	120	06/03 → 03/08	FCP1717	ATE				
2.5 TDI	120	06/03 → 03/08				FCP1491	LUCAS/TRW	PR Number: 1KD
2.8 V6	142	12/01 → 03/08	FCP1717	ATE				
2.8 V6	142	12/01 → 03/08				FCP1491	LUCAS/TRW	PR Number: 1KD

SUPERB (3V3)

1.4 TSI	110	03/15 →	FCP4425	LUCAS/TRW	Pr Number 1LA			
1.4 TSI	110	03/15 →	FCP4433	LUCAS/TRW	Pr Number 1ZA			
1.4 TSI	110	03/15 →				FCP4697	ATE	For PR code:1KU/1KZ
1.4 TSI	92	03/15 →	FCP4425	LUCAS/TRW	Pr Number 1LA			
1.4 TSI	92	03/15 →	FCP4433	LUCAS/TRW	Pr Number 1ZA			
1.4 TSI	92	03/15 →				FCP4697	ATE	For PR code:1KU/1KZ
1.4 TSI 4x4	110	03/15 →	FCP4425	LUCAS/TRW	Pr number 1LA			
1.4 TSI 4x4	110	03/15 →	FCP4433	LUCAS/TRW	Pr Number 1ZA			
1.4 TSI 4x4	110	03/15 →				FCP4697	ATE	For PR code:1KU/1KZ
1.6 TDI	88	03/15 →	FCP4425	LUCAS/TRW	Pr Number 1LA			
1.6 TDI	88	03/15 →	FCP4433	LUCAS/TRW	Pr Number 1ZA			
1.6 TDI	88	03/15 →				FCP4697	ATE	For PR code:1KU/1KZ
1.8 TSI	132	03/15 →	FCP4425	LUCAS/TRW	Pr Number 1LA			
1.8 TSI	132	03/15 →	FCP4433	LUCAS/TRW	Pr Number 1ZA			
1.8 TSI	132	03/15 →				FCP4697	ATE	For PR code:1KU/1KZ
2.0 TDI	110	03/15 →	FCP4425	LUCAS/TRW	Pr Number 1LA			
2.0 TDI	110	03/15 →	FCP4433	LUCAS/TRW	Pr Number 1ZA			
2.0 TDI	110	03/15 →				FCP4697	ATE	For PR code:1KU/1KZ
2.0 TDI	140	03/15 →	FCP4425	LUCAS/TRW	Pr number 1LA			
2.0 TDI	140	03/15 →	FCP4433	LUCAS/TRW	Pr Number 1ZA			
2.0 TDI	140	03/15 →				FCP4697	ATE	For PR code:1KU/1KZ

For material availability see page 16-18 / Per la disponibilità materiali vedere a pagina 16-18



KW

**...SKODA****...SUPERB (3V3)**

					NOTE			NOTE
2.0 TDI 4x4	110	03/15 →	FCP4425	LUCAS/TRW	Pr number 1LA			
2.0 TDI 4x4	110	03/15 →	FCP4433	LUCAS/TRW	Pr Number 1ZA			
2.0 TDI 4x4	110	03/15 →				FCP4697	ATE	For PR code:1KU/1KZ
2.0 TDI 4x4	140	03/15 →	FCP4425	LUCAS/TRW	Pr Number 1LA			
2.0 TDI 4x4	140	03/15 →	FCP4433	LUCAS/TRW	1ZA			
2.0 TDI 4x4	140	03/15 →				FCP4697	ATE	For PR code:1KU/1KZ
2.0 TSI	162	03/15 →	FCP4425	LUCAS/TRW	Pr Number 1LA			
2.0 TSI	162	03/15 →	FCP4433	LUCAS/TRW	Pr Number 1ZA			
2.0 TSI	162	03/15 →				FCP4697	ATE	For PR code:1KU/1KZ
2.0 TSI 4x4	206	03/15 →	FCP4425	LUCAS/TRW	Pr Number 1LA			
2.0 TSI 4x4	206	03/15 →	FCP4433	LUCAS/TRW	Pr Number 1ZA			
2.0 TSI 4x4	206	03/15 →				FCP4697	ATE	For PR code:1KU/1KZ

SUPERB Estate (3V5)

1.4 TSI	110	03/15 →	FCP4425	LUCAS/TRW	Pr Number 1LA			
1.4 TSI	110	03/15 →	FCP4433	LUCAS/TRW	Pr Number 1ZA			
1.4 TSI	110	03/15 →				FCP4697	ATE	For PR code:1KU/1KZ
1.4 TSI	92	03/15 →	FCP4425	LUCAS/TRW	Pr Number 1LA			
1.4 TSI	92	03/15 →	FCP4433	LUCAS/TRW	Pr Number 1ZA			
1.4 TSI	92	03/15 →				FCP4697	ATE	For PR code:1KU/1KZ
1.4 TSI 4x4	110	03/15 →	FCP4425	LUCAS/TRW	Pr Number 1LA			
1.4 TSI 4x4	110	03/15 →	FCP4433	LUCAS/TRW	Pr Number 1ZA			
1.4 TSI 4x4	110	03/15 →				FCP4697	ATE	For PR code:1KU/1KZ
1.6 TDI	88	03/15 →	FCP4425	LUCAS/TRW	Pr Number 1LA			
1.6 TDI	88	03/15 →	FCP4433	LUCAS/TRW	Pr Number 1ZA			
1.6 TDI	88	03/15 →				FCP4697	ATE	For PR code:1KU/1KZ
1.8 TSI	132	03/15 →	FCP4425	LUCAS/TRW	Pr Number 1LA			
1.8 TSI	132	03/15 →	FCP4433	LUCAS/TRW	Pr Number 1ZA			
1.8 TSI	132	03/15 →				FCP4697	ATE	For PR code:1KU/1KZ
2.0 TDI	110	03/15 →	FCP4425	LUCAS/TRW	Pr Number 1LA			
2.0 TDI	110	03/15 →	FCP4433	LUCAS/TRW	Pr Number 1ZA			
2.0 TDI	110	03/15 →				FCP4697	ATE	For PR code:1KU/1KZ
2.0 TDI	140	03/15 →	FCP4425	LUCAS/TRW	Pr Number 1LA			
2.0 TDI	140	03/15 →	FCP4433	LUCAS/TRW	Pr Number 1ZA			
2.0 TDI	140	03/15 →				FCP4697	ATE	For PR code:1KU/1KZ
2.0 TDI 4x4	110	03/15 →	FCP4425	LUCAS/TRW	Pr Number 1LA			
2.0 TDI 4x4	110	03/15 →	FCP4433	LUCAS/TRW	Pr Number 1ZA			
2.0 TDI 4x4	110	03/15 →				FCP4697	ATE	For PR code:1KU/1KZ
2.0 TDI 4x4	140	03/15 →	FCP4425	LUCAS/TRW	Pr Number 1LA			
2.0 TDI 4x4	140	03/15 →	FCP4433	LUCAS/TRW	Pr Number 1ZA			
2.0 TDI 4x4	140	03/15 →				FCP4697	ATE	For PR code:1KU/1KZ
2.0 TSI	162	03/15 →	FCP4425	LUCAS/TRW	Pr Number 1LA			
2.0 TSI	162	03/15 →	FCP4433	LUCAS/TRW	Pr Number 1ZA			
2.0 TSI	162	03/15 →				FCP4697	ATE	For PR code:1KU/1KZ
2.0 TSI 4x4	206	03/15 →	FCP4425	LUCAS/TRW	Pr number 1LA			
2.0 TSI 4x4	206	03/15 →	FCP4433	LUCAS/TRW	Pr number 1ZA			
2.0 TSI 4x4	206	03/15 →				FCP4697	ATE	For PR code:1KU/1KZ

SUPERB II (3T4)

3.6 FSI 4x4	191	11/08 → 05/15	FCP4223	ATE				
3.6 FSI 4x4	191	11/08 → 05/15	FCP1765	ATE	For PR code:1LK			
3.6 FSI 4x4	191	11/08 → 05/15				FCP1636	LUCAS/TRW	

SUPERB II Estate (3T5)

3.6 V6 4x4	191	10/09 → 05/15	FCP4223	ATE				
3.6 V6 4x4	191	10/09 → 05/15	FCP1765	ATE	For PR code:1LK			
3.6 V6 4x4	191	10/09 → 05/15				FCP1636	LUCAS/TRW	

Yeti

1.6 TDi 16v (5L7)	77	11/10 →	FCP1094	ATE	PR 1ZF			
1.6 TDi 16v (5L7)	77	11/10 →	FCP1641	ATE	PR 1ZE			
1.6 TDi 16v (5L7)	77	11/10 →				FCP4316	BOSCH	
1.6 TDi 16v (5L7)	77	11/10 →				FCP4316	BOSCH	
1.8 TFSi 16v (4x4)	112	11/09 →	FCP1641	ATE	PR 1ZE			
1.8 TFSi 16v (4x4)	112	11/09 →				FCP4316	BOSCH	
1.8 TSi 16v (4x4)	118	05/09 →	FCP1641	ATE	PR 1ZE			
1.8 TSi 16v (4x4)	118	05/09 →				FCP4316	BOSCH	
2.0 TDi 16v (4x4)	103	05/09 →	FCP1641	ATE	PR 1ZE			
2.0 TDi 16v (4x4)	103	05/09 →				FCP4316	BOSCH	
2.0 TDi 16v (4x4)	125	11/09 →	FCP1641	ATE	PR 1ZA			
2.0 TDi 16v (4x4)	125	11/09 →				FCP4316	BOSCH	
2.0 TDi 16v (4x4)	81	11/09 →	FCP1641	ATE	PR 1ZE			
2.0 TDi 16v (4x4)	81	11/09 →				FCP4316	BOSCH	
2.0 TDi 16v (5L7)	103	05/09 →	FCP1641	ATE	PR 1ZE			
2.0 TDi 16v (5L7)	103	05/09 →				FCP4316	BOSCH	
2.0 TDi 16v (5L7)	81	11/09 →	FCP1094	ATE	PR 1ZF			
2.0 TDi 16v (5L7)	81	11/09 →	FCP1641	ATE	PR 1ZE			

For material availability see page 16-18 / Per la disponibilità materiali vedere a pagina 16-18

1208**FERODO**

RACING

Updated on 17th Aug 2018



KW

**...SKODA****...Yeti**

2.0 TDi 16v (5L7)	81	11/09 →							
2.0 TDi 16v (5L7)	81	11/09 →				FCP4316	BOSCH		

SMART (until 2002 MCC)**Cabrio (450)**

Cabrio 0.6	40	03/00 → 01/03	FCP1162	BOSCH					
Cabrio 0.6	45	01/01 → 01/04	FCP1162	BOSCH					
Cabrio 0.6	52	01/01 → 01/04	FCP1162	BOSCH					
Cabrio 0.7	40	03/00 → 01/03	FCP1162	BOSCH					
Cabrio 0.7	45	01/03 → 01/04	FCP1162	BOSCH					
Cabrio 0.7	46	01/01 → 01/03	FCP1162	BOSCH					
Cabrio 0.7	55	05/03 → 01/04	FCP1162	BOSCH					
Cabrio 0.8 CDi	30	03/02 → 01/04	FCP1162	BOSCH					

City Coupe (450)

City Coupe 0.6	33	07/98 → 01/04	FCP1162	BOSCH					
City Coupe 0.6	40	07/98 → 01/04	FCP1162	BOSCH					
City Coupe 0.6	45	10/00 → 10/03	FCP1162	BOSCH					
City Coupe 0.6	52	06/02 → 01/04	FCP1162	BOSCH					
City Coupe 0.7	33	07/98 → 01/04	FCP1162	BOSCH					
City Coupe 0.7	37	01/03 → 01/04	FCP1162	BOSCH					
City Coupe 0.7	40	08/98 → 01/03	FCP1162	BOSCH					
City Coupe 0.7	45	01/03 → 01/04	FCP1162	BOSCH					
City Coupe 0.7	55	05/03 → 01/04	FCP1162	BOSCH					
City Coupe 0.8 CDi	30	12/99 → 01/04	FCP1162	BOSCH					

Crossblade (450)

Crossblade 0.6	52	09/02 → 12/03	FCP1162	BOSCH					
----------------	----	---------------	---------	-------	--	--	--	--	--

Fortwo (450)

Fortwo Cabrio 0.6	55	08/03 → 12/06	FCP1162	BOSCH					
Fortwo Cabrio 0.7	45	08/03 → 12/06	FCP1162	BOSCH					
Fortwo Cabrio 0.7	55	08/03 → 12/06	FCP1162	BOSCH					
Fortwo Cabrio 0.8 CDi	30	08/03 → 12/06	FCP1162	BOSCH					
Fortwo Coupe 0.6	37	01/04 → 02/07	FCP1162	BOSCH					
Fortwo Coupe 0.6	45	01/04 → 02/07	FCP1162	BOSCH					
Fortwo Coupe 0.6	55	01/04 → 02/07	FCP1162	BOSCH					
Fortwo Coupe 0.7	37	01/04 → 02/07	FCP1162	BOSCH					
Fortwo Coupe 0.7	45	01/04 → 02/07	FCP1162	BOSCH					
Fortwo Coupe 0.7	55	01/04 → 02/07	FCP1162	BOSCH					
Fortwo Coupe 0.8 CDi	30	01/04 → 02/07	FCP1162	BOSCH					

Fortwo (451)

Fortwo Cabrio 0.0 Elektrik	20	12/10 →	FCP1162	BOSCH					
Fortwo Cabrio 0.0 Elektrik	35	09/11 →	FCP1162	BOSCH					
Fortwo Cabrio 0.8 CDi	33	01/07 →	FCP1162	BOSCH					
Fortwo Cabrio 0.8 CDi	40	08/09 →	FCP1162	BOSCH					
Fortwo Cabrio 1.0	52	01/07 →	FCP1162	BOSCH					
Fortwo Cabrio 1.0	62	01/07 →	FCP1162	BOSCH					
Fortwo Cabrio 1.0	72	01/07 →	FCP1162	BOSCH					
Fortwo Cabrio 1.0	75	07/10 →	FCP1162	BOSCH					
Fortwo Cabrio 1.0 Hybrid	52	01/07 →	FCP1162	BOSCH					
Fortwo Coupe 0.0 Elektrik	20	12/10 →	FCP1162	BOSCH					
Fortwo Coupe 0.0 Elektrik	35	09/11 →	FCP1162	BOSCH					
Fortwo Coupe 0.8 CDi	33	01/07 →	FCP1162	BOSCH					
Fortwo Coupe 0.8 CDi	40	08/09 →	FCP1162	BOSCH					
Fortwo Coupe 1.0	45	01/07 →	FCP1162	BOSCH					
Fortwo Coupe 1.0	52	01/07 →	FCP1162	BOSCH					
Fortwo Coupe 1.0	62	01/07 →	FCP1162	BOSCH					
Fortwo Coupe 1.0	72	01/07 →	FCP1162	BOSCH					
Fortwo Coupe 1.0	75	07/10 →	FCP1162	BOSCH					
Fortwo Coupe 1.0 Hybrid	45	01/07 →	FCP1162	BOSCH					
Fortwo Coupe 1.0 Hybrid	52	01/07 →	FCP1162	BOSCH					

Roadster (452)

Roadster 0.7	45	07/03 → 04/06	FCP1162	BOSCH					
Roadster 0.7	60	01/04 → 08/04	FCP1162	BOSCH					
Roadster 0.7	60	03/04 → 04/06	FCP1162	BOSCH					
Roadster Coupe 0.7	45	07/03 → 04/06	FCP1162	BOSCH					
Roadster Coupe 0.7	60	01/03 → 04/06	FCP1162	BOSCH					
Roadster Coupe 0.7	60	03/04 → 04/06	FCP1162	BOSCH					

SSANGYONG

For material availability see page 16-18 / Per la disponibilità materiali vedere a pagina 16-18



KW



SSANGYONG

Korando

2.3 16V 103 10/97 →

FCP600 AKEBONO

NOTE

NOTE

SUBARU

Baja (US)

2.5 01/01 →

FCP1639 TOKICO

2.5 Turbo 01/01 →

FCP1639 TOKICO

BRZ

2.0 L 147 03/12 →

FCP1639 SUMITOMO

2.0 L 147 03/12 →

FCP4187 SUMITOMO

Forester (US)

2.5 Turbo 193 02/11 →

FCP1639 TOKICO

Forester I (SF)

2.0 S Turbo 130 04/01 → 09/02

FCP1639 TOKICO

Forester II (SG)

2.0 92 09/02 →

FCP1639 TOKICO

2.0 92 09/02 →

FCP1333 AKEBONO

2.0 S Turbo 130 09/02 →

FCP1639 TOKICO

2.0 S Turbo 130 09/02 →

FCP1333 AKEBONO

2.0 X 116 09/01 →

FCP1639 TOKICO

2.0 X 116 09/01 →

FCP1333 AKEBONO

2.5 155 12/01 →

FCP1639 TOKICO

2.5 155 12/01 →

FCP1333 AKEBONO

2.5 155 12/03 →

FCP1639 TOKICO

2.5 XT 169 09/01 →

FCP1639 TOKICO

2.5 XT 169 09/01 →

FCP1333 AKEBONO

Forester III (SH)

2.0 AWD 110 01/08 →

FCP1639 TOKICO

2.0 AWD 110 01/08 →

FCP1947 AKEBONO

2.0 AWD 110 01/10 →

FCP1639 TOKICO

2.0 AWD 110 01/10 →

FCP1947 AKEBONO

2.0 D AWD 108 09/08 →

FCP1639 TOKICO

2.0 D AWD 108 09/08 →

FCP1947 AKEBONO

2.5 AWD 126 01/09 →

FCP1639 TOKICO

2.5 AWD 126 01/09 →

FCP1947 AKEBONO

2.5 AWD 169 06/08 →

FCP1639 TOKICO

2.5 AWD 169 06/08 →

FCP1947 AKEBONO

Forester IV (SJ)

2.0 XT 177 03/13 →

FCP1984 AKEBONO

Impreza

1.5 R 01/01 →

FCP1639 TOKICO

1.6 16V 09/98 →

FCP1327 AKEBONO

1.6 16V 09/98 →

FCP1333 AKEBONO

1.6 GF3, GC3 16V 05/93 → 08/98

FCP789 AKEBONO

1.6 GF3, GC3 16V 05/93 → 08/98

FCP790 AKEBONO ABS

1.8 GF6 16V 05/93 → 08/98

FCP789 AKEBONO

1.8 GF6 16V 05/93 → 08/98

FCP790 AKEBONO ABS

2.0 16V 01/94 → 08/98

FCP789 AKEBONO

2.0 16V 01/94 → 08/98

FCP790 AKEBONO ABS

2.0 16V 01/97 → 12/98

FCP1327 AKEBONO

2.0 16V 01/97 → 12/98

FCP1333 AKEBONO

2.0 GC8 (Turbo) 16V 01/94 → 08/98

FCP948 AKEBONO

2.0 GC8 (Turbo) 16V 01/94 → 08/98

FCP790 AKEBONO

2.0 i 92 12/00 →

FCP986 SUMITOMO

2.0 i 92 12/00 →

FCP1333 AKEBONO

2.0 i 92 01/01 → 12/07

FCP1639 TOKICO

2.0 i 4x4 16V 09/98 →

FCP1327 AKEBONO

2.0 i 4x4 16V 09/98 →

FCP790 AKEBONO

2.0 R 01/01 →

FCP1639 TOKICO

2.0 Sport 01/01 →

FCP1639 TOKICO

2.0 STi (Brembo KIT 6 pistons) 01/08 →

FRP3100 BREMBO

2.0 STi (Brembo KIT 6 pistons) 01/08 →

FCP1562 BREMBO

EVO Gr N 01/06 →

FRP216 AP RACING

EVO Gr N 01/06 →

FRP219 AP RACING

For material availability see page 16-18 / Per la disponibilità materiali vedere a pagina 16-18

1210

FERODO

RACING

Updated on 17th Aug 2018

SSANGYONG



KW



...SUBARU

Impreza (US)

2.0 Turbo WRX	160	01/01 → 12/05	FCP1639	TOKICO			
2.5 RS/TS		01/01 → 12/07	FCP1639	TOKICO			
2.5 WRX Turbo	169	01/01 → 12/05	FCP1639	TOKICO			

Impreza Hatchback

2.5 WRX	169	09/05 →	FCP1639	TOKICO			
2.5 WRX	169	09/05 →			FCP1947	AKEBONO	

Impreza Hatchback (GR, GH, G3)

1.5 All-wheel Drive	79	02/08 →	FCP1639	TOKICO			
1.5 All-wheel Drive	79	02/08 →			FCP1947	AKEBONO	
1.5 F	79	02/08 →			FCP1947	AKEBONO	
2.0	110	02/08 →			FCP1947	AKEBONO	
2.0 D All-wheel Drive	110	01/09 →	FCP1639	TOKICO			
2.0 D All-wheel Drive	110	01/09 →			FCP1947	AKEBONO	
2.0 i All-wheel Drive	110	01/08 →	FCP1639	TOKICO			
2.0 i All-wheel Drive	110	01/08 →			FCP1947	AKEBONO	
2.5 All-wheel Drive	169	01/08 →	FCP1639	TOKICO			
2.5 All-wheel Drive	169	01/08 →			FCP1947	AKEBONO	

Impreza I (GC)

1.6 i	70	06/98 → 12/00	FCP986	SUMITOMO			
1.6 i	70	06/98 → 12/00			FCP790	AKEBONO	(+) ABS
2.0 i 4WD	92	06/98 → 12/00	FCP986	SUMITOMO	01/99->		
2.0 i 4WD	92	06/98 → 12/00			FCP1333	AKEBONO	->12/98, (+) ABS
2.0 Turbo GT 4WD	160	06/98 → 12/00	FCP986	SUMITOMO			

Impreza I SW (GF)

2.0 16V AWD	92	06/98 → 12/00	FCP986	SUMITOMO			
2.0 16V AWD	92	06/98 → 12/00			FCP790	AKEBONO	->12/98, (+) ABS
2.0 Turbo GT 4WD	160	06/98 → 12/00	FCP986	SUMITOMO			

Impreza II (GD, GG)

2.0 WRX STi	195	11/01 → 07/05	FRP3067	BREMBO			
2.0 WRX STi	195	11/01 → 07/05			FCP1562	BREMBO	
2.0 WRX Turbo	160	10/00 → 12/05	FCP986	SUMITOMO			
2.0 WRX Turbo	160	10/00 → 12/05			FCP1372	AKEBONO	
2.0 WRX Turbo	165	12/02 → 03/07	FCP986	SUMITOMO			
2.0 WRX Turbo	165	12/02 → 03/07			FCP1372	AKEBONO	
2.0 WRX Turbo	165	01/15 →	FCP1984	TOKICO			
2.0 WRX Turbo	165	01/15 →			FCP1947	TOKICO	
2.5 i WRX	169	09/05 → 12/08	FCP986	SUMITOMO			
2.5 i WRX	169	09/05 → 12/08			FCP1372	AKEBONO	
2.5 WRX STi	206	09/05 → 12/07	FRP3067	BREMBO			
2.5 WRX STi	206	09/05 → 12/07			FCP1562	BREMBO	

Impreza II SW (GD, GG)

2.0 Turbo	160	12/00 →	FCP986	SUMITOMO			
2.0 Turbo	160	12/00 → 12/05	FCP986	SUMITOMO			
2.0 Turbo	160	12/00 → 12/05			FCP1372	AKEBONO	
2.0 WRX Turbo	165	12/02 → 09/06	FCP986	SUMITOMO			
2.0 WRX Turbo	165	12/02 → 09/06			FCP1372	AKEBONO	
2.5 WRX	169	09/05 → 03/07	FCP986	SUMITOMO			
2.5 WRX	169	09/05 → 03/07			FCP1372	AKEBONO	

Impreza III (GR, GH, G3)

2.5 WRX SE AWD	195	06/12 →	FRP3067	BREMBO			
2.5 WRX SE AWD	195	06/12 →			FCP1562	BREMBO	
2.5 WRX STi	221	01/08 →	FRP3067	BREMBO			
2.5 WRX STi	221	01/08 →			FCP1562	BREMBO	
2.5 WRX STi	294	04/10 →	FRP3067	BREMBO			
2.5 WRX STi	294	04/10 →			FCP1562	BREMBO	
2.5 WRX STi AWD	221	01/11 →	FRP3067	BREMBO			
2.5 WRX STi AWD	221	01/11 →			FCP1562	BREMBO	

Impreza Outback (US)

2.2		01/01 → 12/02	FCP1639	TOKICO			
-----	--	---------------	---------	--------	--	--	--

Impreza Saloon (GR)

1.5	79	02/08 →			FCP1947	AKEBONO	
1.5 AWD	79	02/08 →	FCP1639	TOKICO			
1.5 AWD	79	02/08 →			FCP1947	AKEBONO	

SUBARU

For material availability see page 16-18 / Per la disponibilità materiali vedere a pagina 16-18



KW



...SUBARU

Justy (III)

1.3 1.3i G3X 16V 09/03 →

FCP1459 BOSCH

NOTE

NOTE

Legacy

1.8 4WD (Turbo) 76 07/90 → 12/93

FCP948 AKEBONO

FCP790 AKEBONO

1.8 4WD (Turbo) 76 07/90 → 12/93

FCP789 AKEBONO

1.8 BC3, BF3 16V 76 10/89 → 09/92

FCP790 AKEBONO

1.8 BC3, BF3 16V 76 10/89 → 09/92

FCP1639 TOKICO

2.0 (Turbo) 16V 147 10/91 → 12/93

FCP948 AKEBONO

FCP790 AKEBONO

2.0 (Turbo) 16V 147 10/91 → 12/93

FCP1327 AKEBONO

2.0 2.0 i BE/BH 08/00 →

FCP1333 AKEBONO

2.0 2.0 i BE/BH 08/00 →

FCP789 AKEBONO

2.0 BC5, BF5 16V 85 10/91 → 12/93

FCP789 AKEBONO

FCP790 AKEBONO

2.0 BC5, BF5 16V 85 10/91 → 12/93

FCP789 AKEBONO

2.0 BG5, BD5 16V 01/94 → 08/97

FCP790 AKEBONO

2.0 BG5, BD5 16V 01/94 → 08/97

FCP1639 TOKICO

2.0 TD 01/01 →

FCP789 AKEBONO

FCP790 AKEBONO

2.2 BF7, 8 16V 100 10/89 → 12/93

FCP789 AKEBONO

2.2 BF7, 8 16V 100 10/89 → 12/93

FCP789 AKEBONO

2.2 BG7, BD7 16V 01/94 → 08/97

FCP790 AKEBONO

2.2 BG7, BD7 16V 01/94 → 08/97

FCP1639 TOKICO

2.5 01/01 →

FCP789 AKEBONO

FCP790 AKEBONO

2.5 16V 01/96 → 08/97

FCP1327 AKEBONO

2.5 16V 01/96 → 08/97

FCP1333 AKEBONO

2.5 16V 01/02 →

Legacy (US)

2.5 01/01 →

FCP1639 TOKICO

2.5 GT 01/01 → 12/04

FCP1639 TOKICO

Legacy IV

2.0 101 09/03 →

FCP1639 TOKICO

FCP1947 AKEBONO

2.0 101 09/03 →

FCP1984 AKEBONO

2.0 121 06/05 →

FCP1984 AKEBONO

FCP1333 AKEBONO

2.0 121 06/05 →

FCP1984 AKEBONO

2.0 140 06/05 →

FCP1639 TOKICO

2.0 D 110 02/08 →

FCP1947 AKEBONO

2.0 D 110 02/08 →

FCP1984 AKEBONO

2.0 R 110 09/07 →

FCP1333 AKEBONO

2.0 R 110 09/07 →

FCP1639 TOKICO

2.5 121 09/03 →

FCP1947 AKEBONO

2.5 121 09/03 →

FCP1639 TOKICO

2.5 i 127 09/07 →

FCP1947 AKEBONO

2.5 i 127 09/07 →

FCP1984 AKEBONO

3.0 R 180 09/03 →

FCP1333 AKEBONO

3.0 R 180 09/03 →

Legacy IV Estate (B13_)

2.0 AWD 101 09/03 →

FCP1639 TOKICO

FCP1947 AKEBONO

2.0 AWD 101 09/03 →

FCP1984 AKEBONO

2.0 AWD 121 06/05 →

FCP1984 AKEBONO

FCP1333 AKEBONO

2.0 AWD 121 06/05 →

FCP1984 AKEBONO

2.0 AWD 140 06/05 →

FCP1639 TOKICO

2.0 D AWD 110 02/08 →

FCP1947 AKEBONO

2.0 D AWD 110 02/08 →

FCP1984 AKEBONO

2.0 R AWD 110 09/07 →

FCP1333 AKEBONO

2.0 R AWD 110 09/07 →

FCP1639 TOKICO

2.5 AWD 121 09/03 →

FCP1947 AKEBONO

2.5 AWD 121 09/03 →

FCP1639 TOKICO

2.5 i AWD 127 01/08 →

FCP1947 AKEBONO

2.5 i AWD 127 01/08 →

FCP1984 AKEBONO

3.0 R AWD 180 09/03 →

FCP1333 AKEBONO

3.0 R AWD 180 09/03 →

Legacy V

2.0 D AWD 110 09/09 →

FCP1639 TOKICO

FCP1947 AKEBONO

2.0 D AWD 110 09/09 →

FCP1984 AKEBONO

2.5 GT AWD 195 07/10 →

FCP4187 SUMITOMO

2.5 GT AWD 195 07/10 →

FCP1639 TOKICO

2.5 i AWD 123 09/09 →

FCP1947 AKEBONO

2.5 i AWD 123 09/09 →

FCP4187 SUMITOMO

3.6 AWD 191 09/10 →

For material availability see page 16-18 / Per la disponibilità materiali vedere a pagina 16-18

1212

FERODO

RACING

Updated on 17th Aug 2018



KW



...SUBARU

Legacy V Estate

2.0 D	110	09/09 →	FCP1639	TOKICO
2.0 D	110	09/09 →		
2.0 i	110	09/09 →	FCP1639	TOKICO
2.0 i	110	09/09 →		
2.5 GT	195	07/10 →	FCP1984	AKEBONO
2.5 GT	195	07/10 →		
2.5 i	123	09/09 →	FCP1639	TOKICO
2.5 i	123	09/09 →		

Outback

2.0 TD		01/01 →	FCP1639	TOKICO
2.5		01/01 →	FCP1639	TOKICO
3.0		01/01 →	FCP1639	TOKICO

Outback (BL, BP)

2.0 D	110	09/08 → 09/09	FCP1639	TOKICO
2.0 D	110	09/08 → 09/09		
2.5	121	11/03 → 09/09	FCP1327	AKEBONO
2.5	121	11/03 → 09/09	FCP1639	TOKICO
2.5	121	11/03 → 09/09		
2.5	121	11/03 → 09/09		
2.5	127	09/08 → 09/09	FCP1639	TOKICO
2.5	127	09/08 → 09/09		

Outback (BM, BR)

2.0 D	110	09/09 →	FCP1639	TOKICO
2.0 D	110	09/09 →		
2.5 i	123	09/09 →	FCP1639	TOKICO
2.5 i	123	09/09 →		
3.6 R	191	09/09 →	FCP1984	AKEBONO
3.6 R	191	09/09 →		

Outback (US)

2.5		01/01 → 12/04	FCP1639	TOKICO
2.5		01/01 →	FCP1639	SUMITOMO
2.5 Turbo		01/01 →	FCP1639	SUMITOMO
3.0		01/01 →	FCP1639	SUMITOMO

SVX

3.3 i Coupe	169	01/92 → 12/97		
-------------	-----	---------------	--	--

Tribeca (B9)

3.0	184	01/05 →	FCP1984	AKEBONO
3.0	184	01/05 →		
3.0	180	10/06 →	FCP1984	AKEBONO
3.0	180	10/06 →		
3.6	188	01/12 →	FCP1984	AKEBONO
3.6	190	09/07 →	FCP1984	AKEBONO
3.6	190	09/07 →		

SUNBEAM

Rapier

		01/59 → 12/67	FCP823	LOCKHEED
--	--	---------------	--------	----------

Venezia

		01/64 → 12/65	FCP823	LOCKHEED
--	--	---------------	--------	----------

SUZUKI

Swift

1.0 1.0i		01/98 →	FCP1459	BOSCH
1.3 1.3i		01/98 →	FCP1459	BOSCH
Swift Cup (NZ-Australia)- Tokico Caliper		01/10 →	FRP3118	SUMITOMO

Swift III

1.3	68	05/05 →	FCP1617	LUCAS/TRW
1.5	75	05/05 →	FCP1617	LUCAS/TRW
1.6	92	05/06 →	FCP1617	LUCAS/TRW
1.6	92	05/06 →		
1.6 Tokico Caliper	92	05/06 →	FRP3118	SUMITOMO

NOTE

NOTE

SUZUKI

For material availability see page 16-18 / Per la disponibilità materiali vedere a pagina 16-18



KW

**...SUZUKI****Swift IV**

1.2	66	10/10 →	FCP4426	LUCAS/TRW
1.2	66	10/10 →		
1.2	69	10/10 →	FCP4426	LUCAS/TRW
1.2	69	10/10 →		
1.2 4x4	66	10/10 →	FCP4426	LUCAS/TRW
1.2 4x4	66	10/10 →		
1.2 4x4	69	10/10 →	FCP4426	LUCAS/TRW
1.2 4x4	69	10/10 →		
1.3 DDiS	55	10/10 →	FCP4426	LUCAS/TRW
1.3 DDiS	55	10/10 →		
1.6	100	01/12 →	FCP4426	LUCAS/TRW
1.6	100	01/12 →		

TALBOT**1000**

1.0 1000, Rallye I		01/69 → 12/81	FCP3	ATE
1.0 Rallye II, III		09/72 → 12/81	FCP2	ATE

1100

1.1 Not Ti		10/70 → 12/84	FCP3	ATE
------------	--	---------------	------	-----

Avenger

1.2		01/70 → 12/73	FCP809	LUCAS/TRW
1.3		09/79 → 04/81	FCP810	LUCAS/TRW
1.3 GT, SW Estate		01/70 → 12/76	FCP810	LUCAS/TRW
1.5		01/70 → 12/73	FCP809	LUCAS/TRW
1.6		09/79 → 04/81	FCP810	LUCAS/TRW

SAMBA (51A)

0.9	31	01/81 → 12/85	FCP72	BENDIX
1.1	37	01/81 → 06/86	FCP72	BENDIX
1.2 Rallye	65	01/83 → 10/86	FCP72	BENDIX
1.4	44	06/83 → 10/86	FCP72	BENDIX
1.4	53	01/81 → 06/86	FCP72	BENDIX
1.4 Rallye	58	01/83 → 10/86	FCP72	BENDIX

SAMBA Convertible (51E)

1.4	58	01/81 → 06/86	FCP72	BENDIX
-----	----	---------------	-------	--------

Simca 1301

1.3	43, 48	01/66 → 12/76	FCP2	ATE
-----	--------	---------------	------	-----

Simca 1501

1.5	54	01/66 → 12/76	FCP2	ATE
-----	----	---------------	------	-----

Sunbeam

0.9	33	09/77 → 05/81	FCP810	LUCAS/TRW
1.3	42, 50	09/77 → 05/81	FCP810	LUCAS/TRW
1.6	59	09/77 → 05/81	FCP810	LUCAS/TRW
2.2	110, 114	10/79 → 03/82	FCP810	LUCAS/TRW

TATRA**T613**

All		01/78 → 12/95		
-----	--	---------------	--	--

T700

All i		01/95 →		
-------	--	---------	--	--

NOTE

NOTE

FCP4430 AKEBONO

FCP4430 AKEBONO

FCP4430 AKEBONO

FCP4430 AKEBONO

FCP4430 AKEBONO

FCP4430 AKEBONO

FCP4430 AKEBONO

FCP3 ATE

FCP2 ATE

FCP3 ATE

FCP809 LUCAS/TRW

FCP810 LUCAS/TRW

FCP810 LUCAS/TRW

FCP809 LUCAS/TRW

FCP810 LUCAS/TRW

FCP72 BENDIX

FCP72 BENDIX

FCP72 BENDIX

FCP72 BENDIX

FCP72 BENDIX

FCP72 BENDIX

FCP72 BENDIX

FCP2 ATE

FCP2 ATE

FCP810 LUCAS/TRW

FCP810 LUCAS/TRW

FCP810 LUCAS/TRW

FCP810 LUCAS/TRW

FCP461 ATE

FCP461 ATE

For material availability see page 16-18 / Per la disponibilità materiali vedere a pagina 16-18

1214

FERODO

RACING

Updated on 17th Aug 2018

SUZUKI



KW



TESLA

MODEL S

				NOTE		NOTE
60	225	11/13 → 04/15	FRP3067	BREMBO		
60	225	11/13 → 04/15			FCP1348	BREMBO
60	283	02/15 → 04/15	FRP3067	BREMBO		
60	283	02/15 → 04/15			FCP1348	BREMBO
60	285	06/16 →	FRP3067	BREMBO		
60	285	06/16 →			FCP1348	BREMBO
70	235	09/15 →	FRP3067	BREMBO		
70	235	09/15 →			FCP1348	BREMBO
70	285	09/15 →	FRP3067	BREMBO		
70	285	09/15 →			FCP1348	BREMBO
70D AWD	245	04/15 →	FRP3067	BREMBO		
70D AWD	245	04/15 →			FCP1348	BREMBO
70D AWD	386	09/15 →	FRP3067	BREMBO		
70D AWD	386	09/15 →			FCP1348	BREMBO
75	285	06/16 →	FRP3067	BREMBO		
75	285	06/16 →			FCP1348	BREMBO
75D AWD	386	06/16 →	FRP3067	BREMBO		
75D AWD	386	06/16 →			FCP1348	BREMBO
85	270	09/12 → 02/16	FRP3067	BREMBO		
85	270	09/12 → 02/16			FCP1348	BREMBO
85	283	02/15 → 02/16	FRP3067	BREMBO		
85	283	02/15 → 02/16			FCP1348	BREMBO
85	285	09/15 → 02/16	FRP3067	BREMBO		
85	285	09/15 → 02/16			FCP1348	BREMBO
85D AWD	315	04/15 → 02/16	FRP3067	BREMBO		
85D AWD	315	04/15 → 02/16			FCP1348	BREMBO
85D AWD	386	09/15 → 02/16	FRP3067	BREMBO		
85D AWD	386	09/15 → 02/16			FCP1348	BREMBO
90D AWD	310	03/16 →	FRP3067	BREMBO		
90D AWD	310	03/16 →			FCP1348	BREMBO
P100D AWD	568	10/16 →	FRP3067	BREMBO		
P100D AWD	568	10/16 →			FCP1348	BREMBO
P85	310	11/13 → 02/16	FRP3067	BREMBO		
P85	310	11/13 → 02/16			FCP1348	BREMBO
P85D AWD	515	10/14 → 02/16	FRP3067	BREMBO		
P85D AWD	515	10/14 → 02/16			FCP1348	BREMBO
P85D AWD	568	09/15 → 02/16	FRP3067	BREMBO		
P85D AWD	568	09/15 → 02/16			FCP1348	BREMBO
P90D AWD	346	03/16 →	FRP3067	BREMBO		
P90D AWD	346	03/16 →			FCP1348	BREMBO
P90D AWD	397	03/16 →	FRP3067	BREMBO		
P90D AWD	397	03/16 →			FCP1348	BREMBO

TOYOTA

Alphard

Alphard 240	125	01/08 →	FRP3121			
Alphard 350	206	01/08 →	FRP3121			

Alphard I

2.4	117	09/03 → 04/08	FRP3120	AKEBONO		
2.4	96	09/03 → 04/08	FRP3120	AKEBONO		
2.4 4WD	117	09/03 → 04/08	FRP3120	AKEBONO		
2.4 Hybrid	117	09/03 → 04/08	FRP3120	AKEBONO		
2.4 Hybrid 4WD	117	09/03 → 04/08	FRP3120	AKEBONO		
2.4 Hybrid 4WD	96	09/03 → 04/08	FRP3120	AKEBONO		
3.0	162	09/03 → 04/08	FRP3120	AKEBONO		
3.0 4WD	162	09/03 → 04/08	FRP3120	AKEBONO		

Avalon

		01/98 → 12/01	FCP1437	AKEBONO		
--	--	---------------	---------	---------	--	--

Aygo

1.0 GPL	50	07/05 →	FCP1790	BOSCH		
1.0 VVTi	50	07/05 →	FCP1790	BOSCH		
1.4 D4d	40	07/05 →	FCP1790	BOSCH		

Camry

1.8		01/82 → 12/86	FCP308	AKEBONO		
1.8	66	11/86 → 12/89	FCP308	AKEBONO		
2.0		10/91 → 12/92	FCP867	AKEBONO		
2.0	66	03/83 → 10/86	FCP308	AKEBONO		
2.0	73, 79	04/84 → 01/87	FCP308	AKEBONO		
2.0 TD	62	04/84 → 10/86	FCP602	AKEBONO		
2.0 TD	62	11/86 → 01/88	FCP602	AKEBONO		

TOYOTA

For material availability see page 16-18 / Per la disponibilità materiali vedere a pagina 16-18



KW

**...TOYOTA****...Camry**

2.0 TD	62	02/88 → 05/91	FCP602	AKEBONO
2.0 TD Executive	62	01/84 → 12/87	FCP308	AKEBONO
2.2 (SXV10) 16V	100	10/91 → 09/96	FCP867	AKEBONO
2.2 (SXV20) 16V	96	10/96 →	FCP867	AKEBONO
2.5 (VZV21) 24V	118	02/88 → 08/88	FCP602	AKEBONO
2.5 24V	118	03/89 → 09/91	FCP602	AKEBONO
2.5 24V	118	10/91 → 12/92	FCP867	AKEBONO
Solara 6 cyl		01/92 → 12/01	FCP1437	AKEBONO

CAMRY (_V2_)

2.0 (SV21_)	94	11/86 → 05/91	FCP602	AKEBONO
2.0 Gli 16V (SV21_)	89	11/86 → 05/91	FCP602	AKEBONO
2.0 Turbo-D (CV20_)	62	11/86 → 05/91	FCP602	AKEBONO
2.0 Turbo-D (CV20_)	63	11/88 → 05/91	FCP602	AKEBONO

CAMRY Station Wagon (_V2_)

2.0 (SV21_)	94	11/86 → 05/91	FCP602	AKEBONO
2.0 GLi 16V (SV21_)	89	11/86 → 02/93	FCP602	AKEBONO
2.0 Turbo-D (CV20_)	62	11/86 → 05/91	FCP602	AKEBONO
2.0 Turbo-D (CV20_)	63	11/88 → 05/91	FCP602	AKEBONO

Carina

1.6 AT151	52, 63	10/83 → 12/88	FCP308	AKEBONO
2.0 D (CT150)		10/83 → 12/88	FCP308	AKEBONO

Carina E

1.6 (AT190) 16V	73, 85	05/92 → 09/97	FCP867	AKEBONO
1.8 (AT191) 16V	79	01/95 → 12/98	FCP867	AKEBONO
2.0 D (CT190)	54, 62	01/92 → 12/98	FCP867	AKEBONO
2.0 Not GTi 16V	94	05/92 → 09/97	FCP867	AKEBONO

Carina II

1.6	66	04/84 → 02/88	FCP308	AKEBONO
1.6	66	03/88 → 05/92	FCP602	AKEBONO
1.6	70	04/84 → 02/88	FCP308	AKEBONO
1.6	70	03/88 → 05/92	FCP602	AKEBONO
1.6	77	04/84 → 02/88	FCP308	AKEBONO
1.6	77	03/88 → 05/92	FCP602	AKEBONO
1.8 (ST150)	74	04/84 → 03/88	FCP308	AKEBONO
2.0	88, 94	04/84 → 02/89	FCP308	AKEBONO
2.0	88, 94	03/89 → 05/92	FCP602	AKEBONO
2.0 D (CT170)	54	01/88 → 12/92	FCP308	AKEBONO

Celica

1.6 AT160 16V	63, 91	01/85 → 12/89	FCP308	AKEBONO
1.6 i	55	01/77 → 12/82	FCP170	SUMITOMO
1.6 i	63	01/77 → 12/82	FCP170	SUMITOMO
1.6 i	79	01/77 → 12/82	FCP170	SUMITOMO
1.6 Sti 16V	77	01/94 → 10/99	FCP867	AKEBONO
1.6 Sti 16V	77, 85	01/90 → 12/94	FCP308	AKEBONO
1.8 16V	85	11/95 → 10/99	FCP867	AKEBONO
1.8 VVTi 16V	105	11/99 →	FCP1528	AKEBONO
2.0	77, 88	11/85 → 01/90	FCP308	AKEBONO
2.0 16V	115	01/90 → 03/94	FCP602	AKEBONO
2.0 16V	118, 136	01/90 → 03/94	FCP602	AKEBONO
2.0 16V	129	03/94 → 10/99	FCP867	AKEBONO
2.0 16V	150	01/90 → 03/94	FCP602	AKEBONO
2.0 GT 16V	115	01/90 → 03/94	FCP602	AKEBONO
2.0 i	65	01/77 → 12/82	FCP170	SUMITOMO
2.0 i	77	01/77 → 12/82	FCP170	SUMITOMO
2.0 i	86	01/77 → 12/82	FCP170	SUMITOMO

CELICA (ZZT23_)

1.8 16V TS	141	08/99 → 08/02	FCP1392	AKEBONO
1.8 16V TS	141	09/02 → 03/06	FCP1528	AKEBONO

Corolla

1.3		01/83 → 08/87	FCP308	AKEBONO
1.3 (AE80/EE80)	48, 55	05/83 → 12/88	FCP308	AKEBONO
1.3 (EE101) 16V		08/92 → 04/97	FCP867	AKEBONO
1.3 (EE90)	52, 55	08/87 → 08/92	FCP308	AKEBONO
1.3 i EE101 16V		08/95 → 04/97	FCP867	AKEBONO
1.4 VVTi (E12U)	71	01/02 →	FCP1573	LUCAS/TRW
1.6 (AE101) 16V		08/92 → 04/97	FCP867	AKEBONO
1.6 (AE82)	54, 63	05/83 → 12/88	FCP308	AKEBONO
1.6 (AE92) 16V		01/87 → 12/92	FCP308	AKEBONO

NOTE

NOTE

For material availability see page 16-18 / Per la disponibilità materiali vedere a pagina 16-18

1216

FERODO

RACING

Updated on 17th Aug 2018



KW

**...TOYOTA****...Corolla**

1.6 (AE92) GTI 16V		01/87 → 12/92	FCP308	AKEBONO
1.6 (AE95) 4WD 16V	77	03/88 → 04/91	FCP308	AKEBONO
1.6 (AE95) Not 4WD	77	08/87 → 08/92	FCP308	AKEBONO
1.6 GT (AE82) 16V	85, 91	10/84 → 08/87	FCP308	AKEBONO
1.6 GT (AE82) 16V	91	05/87 → 12/88	FCP308	AKEBONO
1.6 Not GT		01/83 → 05/87	FCP308	AKEBONO
1.6 VVTi (E12U)	81	01/02 →	FCP1573	LUCAS/TRW
1.8 (AE102) 16V		08/92 → 07/95	FCP867	AKEBONO
1.8 D (CE70)		01/83 → 05/87	FCP308	AKEBONO
1.8 D (CE80)		01/83 → 05/87	FCP308	AKEBONO
1.8 D (CE90)		06/87 → 08/92	FCP308	AKEBONO
1.8 D SW Estate		01/90 →	FCP308	AKEBONO
1.8 VVTi (E12U)	141	01/02 →	FCP1573	LUCAS/TRW
2.0 D (CE100)	54	11/92 → 07/95	FCP867	AKEBONO

Corolla (_ E12_)

1.8 VVTi- TS (ZZE123)	165	02/05 → 02/07	FCP1573	LUCAS/TRW
-----------------------	-----	---------------	---------	-----------

Corolla Verso

1.4 i VVTi 16V	71	01/02 → 03/04	FCP1528	AKEBONO
1.6 16V	81	01/02 →	FCP1528	AKEBONO
1.6 i VVTi 16V	81	04/04 →	FCP1528	AKEBONO
1.8 16V	99	01/02 →	FCP1528	AKEBONO
2.0 D4D	66	01/02 →	FCP1528	AKEBONO

Corolla Wagon (_ E11_)

2.0 D-4D	66	09/00 → 10/01	FCP1573	LUCAS/TRW
2.0 D-4D	81	01/02 → 12/06	FCP1573	LUCAS/TRW

Corona

1.6		01/83 → 12/85	FCP308	AKEBONO
1.8	85	10/83 → 12/85	FCP308	AKEBONO
2.0		10/83 → 12/85	FCP308	AKEBONO
2.0 2000		01/83 →	FCP308	AKEBONO

Cressida

2.0 i GX71 24V	110	01/84 → 12/88	FCP170	SUMITOMO
2.4 TD LX70/71	66	08/84 → 12/88	FCP170	SUMITOMO

FJ CRUISER (GSJ1_)

4.0 i V6	200	12/10 →	FCP1698	SUMITOMO
4.0 i V6	200	12/10 →		FCP1021 SUMITOMO
4.0 i V6	203	01/11 →	FCP1698	SUMITOMO
4.0 i V6	203	01/11 →		FCP1021 SUMITOMO
4.0 i V6 4WD	193	12/10 →	FCP1698	SUMITOMO
4.0 VVTi	178	01/06 → 12/11	FCP1698	SUMITOMO
4.0 VVTi 4WD	178	01/06 → 12/11	FCP1698	SUMITOMO
4.0 VVTi 4WD	178	01/06 → 12/11		FCP1021 SUMITOMO

FORTUNER (TGN6_, KUN6_, GGN6_, TGN5_, LAN5_, KUN5_, GGN5_)

2.5 D-4D 4WD	75	01/09 → 05/15	FCP1698	SUMITOMO
3.0 D 4WD	125	08/09 → 05/15	FCP1698	SUMITOMO

FT-86

2.0 L	147	03/12 →	FCP1639	SUMITOMO
2.0 L	147	03/12 →		FCP4187 SUMITOMO

GT-86

2.0 L	147	03/12 →	FCP1639	SUMITOMO
2.0 L	147	03/12 →		FCP4187 SUMITOMO

HIACE

RZH101G		01/93 → 12/02	FRP3127	
RZH102V		01/96 → 12/03	FRP3127	
RZH111G		01/95 → 12/02	FRP3127	
RZH112K		01/96 → 12/03	FRP3127	
RZH112V		01/96 → 12/03	FRP3127	
RZH124B		01/96 → 12/03	FRP3127	

HIACE / COMMUTER IV (TRH2_, KDH2_)

2.5 D-4D	75	09/06 →	FCP4327	AKEB/SUMI
2.5 D-4D 4WD	94	01/05 →	FCP4327	AKEB/SUMI
2.7 VVTi	111	01/05 →	FCP4327	AKEB/SUMI
3.0 D	100	01/05 →	FCP4327	AKEB/SUMI

TOYOTA

For material availability see page 16-18 / Per la disponibilità materiali vedere a pagina 16-18

FERODO

RACING

Updated on 17th Aug 2018

1217



KW



...TOYOTA

HIACE IV Box (LXH1_, RZH1_, LH1_)

2.5 D-4D	70	09/06 →	FCP4327	AKEB/SUMI				
2.5 D-4D	86	09/06 →	FCP4327	AKEB/SUMI				

HIACE IV Box (TRH2_, KDH2_)

2.5 D-4D	70	09/06 →	FCP4327	AKEB/SUMI				
2.5 D-4D	75	09/06 →	FCP4327	AKEB/SUMI				
2.5 D-4D	86	09/06 →	FCP4327	AKEB/SUMI				
2.7 VVTi (TRH201, TRH221)	111	01/05 →	FCP4327	AKEB/SUMI				
3.0 D	100	01/05 →	FCP4327	AKEB/SUMI				

HILUX Closed Off-Road Vehicle (RZN1_, LN1_)

2.7	107	08/01 → 07/04	FCP1698	SUMITOMO				
3.4 4WD	131	08/00 → 07/04	FCP1698	SUMITOMO				

HILUX II Pickup (RN6_, RN5_, LN6_, YN6_, YN5_, LN5_)

3.4	131	08/01 → 07/05	FCP1698	SUMITOMO				
3.4 4WD	131	08/01 → 07/05	FCP1698	SUMITOMO				

HILUX III Pickup (TGN1_, GGN2_, LAN_, GGN1_, KUN2_, KUN1_)

2.5 D-4D	106	01/10 →	FCP1698	SUMITOMO				
2.5 D-4D 4WD	106	12/07 →	FCP1698	SUMITOMO				
3.0 D 4WD (KUN26)	120	08/05 →	FCP1698	SUMITOMO				
3.0 D-4D 4WD	145	05/08 →	FCP1698	SUMITOMO				

LAND CRUISER (LJ12_, KDJ12_, KZJ12_, GRJ12_, TRJ12_)

2.7 (RZJ12)	112	09/02 → 08/04	FCP1698	SUMITOMO				
2.7 (RZJ12)	112	09/02 → 08/04			FCP1021	SUMITOMO		
2.7 (TRJ12)	120	11/03 → 02/10	FCP1698	SUMITOMO				
2.7 (TRJ12)	120	11/03 → 02/10			FCP1021	SUMITOMO		
3.0 D	70	09/02 → 07/09	FCP1698	SUMITOMO				
3.0 D	70	09/02 → 07/09			FCP1021	SUMITOMO		
3.0 D-4D (KDJ120, KDJ125)	127	09/02 →	FCP1698	SUMITOMO				
3.0 D-4D (KDJ120, KDJ125)	127	09/02 →			FCP1021	SUMITOMO		
3.0 D-4D (KDJ120, KDJ150, KDJ125)	120	01/03 → 02/10	FCP1698	SUMITOMO				
3.0 D-4D (KDJ120, KDJ150, KDJ125)	120	01/03 → 02/10			FCP1021	SUMITOMO		
3.0 D-4D (KZJ12)	92	09/02 → 02/10	FCP1698	SUMITOMO				
3.0 D-4D (KZJ12)	92	09/02 → 02/10			FCP1021	SUMITOMO		
3.4	136	09/02 → 08/04	FCP1698	SUMITOMO				
4.0	179	09/02 → 08/04	FCP1698	SUMITOMO				
4.0	179	09/02 → 08/04			FCP1021	SUMITOMO		
4.0 (GRJ12, GRJ125)	183	01/03 →	FCP1698	SUMITOMO				
4.0 (GRJ12, GRJ125)	183	01/03 →			FCP1021	SUMITOMO		

LAND CRUISER (PZJ7_, KZJ7_, HZJ7_, BJ7_, LJ7_, RJ7_)

2.4 (RJ70_, RJ73_)	77	11/84 → 05/93			FCP1021	SUMITOMO		
2.4 (RJ70_, RJ73_)	81	11/84 → 05/93			FCP1021	SUMITOMO		
2.4 (RJ70_V, RJ73_V)	84	12/88 → 12/96			FCP1021	SUMITOMO		
2.4 TD (LJ70)	66	01/90 → 05/93			FCP1021	SUMITOMO		
2.4 TD (LJ70_, LJ73_)	63	10/85 → 05/90			FCP1021	SUMITOMO		
3.0 TD (KZJ70_, KZJ73_, KZJ77_)	92	05/93 → 05/96			FCP1021	SUMITOMO		
3.5 D 4x4 (PZJ75, PZJ70)	85	01/90 → 12/94			FCP1021	SUMITOMO		
4.2 TD (HZJ7_V)	96	01/90 →	FCP1456	SUMITOMO				
4.2 TD (HZJ7_V)	96	01/90 →			FCP1021	SUMITOMO		
4.2 TD (HZJ7_V)	96	01/90 →			FCP1457	SUMITOMO		
4.5 TD 24V 4x4 (VDJ76, VDJ78)	151	03/07 →	FCP1456	SUMITOMO				

LAND CRUISER 100 (FZJ1_, UZJ100)

4.2 D (HZJ105)	96	03/98 → 10/07	FCP1456	SUMITOMO				
4.2 TD (HDJ100_)	150	01/98 →	FCP1456	SUMITOMO				
4.2 TD (HDJ100_)	150	01/98 →			FCP1457	SUMITOMO		
4.7 (UZJ100)	175	02/02 →	FCP1456	SUMITOMO				
4.7 (UZJ100)	175	02/02 →			FCP1457	SUMITOMO		
4.7 (UZJ100_)	173	01/98 →	FCP1456	SUMITOMO				
4.7 (UZJ100_)	173	01/98 →			FCP1457	SUMITOMO		

LAND CRUISER 100 (UZJ100)

4.2 TDi 24V (HDJ100)	150	01/98 → 07/08	FCP1456	SUMITOMO				
----------------------	-----	---------------	---------	----------	--	--	--	--

LAND CRUISER 150 (KDJ15_, GRJ15_)

2.7	120	01/10 →	FCP1456	SUMITOMO				
2.7	120	01/10 →	FCP1698	SUMITOMO				
2.8 D-4D	130	06/15 →	FCP1456	SUMITOMO				
2.8 D-4D	130	06/15 →	FCP1698	SUMITOMO				
2.8 D-4D	130	06/15 →			FCP1021	SUMITOMO		
3.0 D-4D	127	03/10 →	FCP1456	SUMITOMO				

For material availability see page 16-18 / Per la disponibilità materiali vedere a pagina 16-18

1218

FERODO

RACING

Updated on 17th Aug 2018

TOYOTA



KW



...TOYOTA

...LAND CRUISER 150 (KDJ15_, GRJ15_)

3.0 D-4D	127	03/10 →	FCP1698	SUMITOMO	
3.0 D-4D	127	03/10 →			
3.0 D-4D	140	01/10 →	FCP1456	SUMITOMO	
3.0 D-4D	140	01/10 →	FCP1698	SUMITOMO	
3.0 D-4D	140	01/10 →			
4.0 V6 Dual VVTi	205	01/10 →	FCP1456	SUMITOMO	
4.0 V6 Dual VVTi	205	01/10 →	FCP1698	SUMITOMO	
4.0 V6 VVT-i	207	01/10 →	FCP1456	SUMITOMO	
4.0 V6 VVT-i	207	01/10 →	FCP1698	SUMITOMO	
4.0 V6 VVT-i	207	01/10 →			
4.0 V6 VVTi	183	01/10 →	FCP1698	SUMITOMO	
4.0 V6 VVTi	203	01/10 →	FCP1698	SUMITOMO	

LAND CRUISER 80 (_J8_)

4.0 (FJ80_)	115	01/90 → 08/92			
4.2 D (HZJ80_)	99	01/90 → 12/97			
4.2 TD (HDJ80)	118	10/92 → 12/97			
4.2 TD (HDJ80)	123	01/90 → 12/97			
4.2 TD 24V (HDJ80_)	125	03/95 →			
4.5 24V (FZJ80_)	151	08/92 → 12/97			

LAND CRUISER 90 (_J9_)

2.7	110	04/95 → 07/02			
3.0 D-4D (KDJ90, KDJ95, KDJ 125)	120	10/00 →			
3.0 TD	103	04/95 → 07/00			
3.0 TD (KZJ90_, KZJ95_)	92	04/96 →			
3.4 i 24V (VZJ90_, VZJ95_)	131	04/96 →			
4.7	175	08/02 →	FCP1456	SUMITOMO	

LAND CRUISER Hardtop (_J7_)

2.4 TD (LJ77)	66	07/90 → 05/96			
3.0 TD	92	05/93 → 05/96			
4.2 D	123	07/90 → 05/96			

LAND CRUISER Pickup (_J7_)

4.2 TD 4x4 (HZJ7_V)	96	01/90 → 02/07	FCP1456	SUMITOMO	
---------------------	----	---------------	---------	----------	--

LAND CRUISER PRADO (LJ12_, KDJ12_, KZJ12_, GRJ12_, TRJ12_)

3.0 D-4D (KDJ120, KDJ125)	122	08/04 → 02/10	FCP1698	SUMITOMO	
3.0 D-4D (KDJ120, KDJ125)	122	08/04 → 02/10			

MR2 I (W1)

1.6 16V (AW11)	85	11/84 → 06/90	FCP308	AKEBONO	
----------------	----	---------------	--------	---------	--

MR2 III (W3)

1.8 VT-i 16V	103	05/00 →	FCP1392	AKEBONO	
--------------	-----	---------	---------	---------	--

Paseo

1.5 16V	66	11/95 → 03/99	FCP308	AKEBONO	
---------	----	---------------	--------	---------	--

Picnic

2.0 16V	94	08/96 →	FCP867	AKEBONO	
2.2 TD	66	08/96 →	FCP867	AKEBONO	

PRADO

3.0 D (GRJ120, KZJ120, RZJ120)	120	01/03 → 12/06	FCP1698	SUMITOMO	
3.0 D (GRJ120, KZJ120, RZJ120)	120	01/03 → 12/06			
3.0 TD 2 Door SWB Wagon (KDJ155)		01/09 →	FCP1698		
3.0 TD 2 Door SWB Wagon (KDJ155)		01/09 →			
4.6 V6 Door Wagon (KDJ150, GRJ150)		01/09 →	FCP1698		
4.6 V6 Door Wagon (KDJ150, GRJ150)		01/09 →			

Prius

1.5 Hybrid	54	05/00 →	FCP1392	AKEBONO	
------------	----	---------	---------	---------	--

RAV4

2.0 i 16V	90	06/94 → 07/00	FCP867	AKEBONO	
-----------	----	---------------	--------	---------	--

SIENNA (_L3_)

3.5 4WD (GSL35_)	198	01/10 →	FCP4354	ADVICS	
------------------	-----	---------	---------	--------	--

TOYOTA

For material availability see page 16-18 / Per la disponibilità materiali vedere a pagina 16-18



KW



!



!

TOYOTA

...TOYOTA				NOTE		NOTE	
Tercel							
1.3 (AL20)	51	01/82 → 12/84	FCP308	AKEBONO			
1.5	55	01/82 → 04/88	FCP308	AKEBONO			
1.5 4WD	55	01/82 → 12/88	FCP308	AKEBONO			
Vios (_P4_)							
1.3 VVTi (AXP41_)	64	07/02 → 01/08	FCP1368	AKEBONO			
1.5 (AXP42_,NCP42_)	68	07/02 → 01/08	FCP1368	AKEBONO			
1.5 VVTi (AXP42_,NCP42_)	78	07/02 → 01/08	FCP1368	AKEBONO			
Yaris							
1.0 16V	50	04/99 →	FCP1368	AKEBONO			
1.3 16V	63	04/99 →	FCP1368	AKEBONO			
1.4 D D-4D 16V	55	02/02 →	FCP1392	AKEBONO			
1.5 T-Sport 16V	78	01/01 →	FCP1392	AKEBONO			
YARIS (NHP13_, NSP13_, NCP13_, KSP13_, NLP13_)							
1.3	70	09/11 →	FCP4081	Advics			
1.3	73	09/11 →	FCP4081	Advics			
1.3 4WD	70	12/10 →	FCP4081	Advics			
1.3 VVT-i	63	12/10 →	FCP4081	Advics			
YARIS (SCP9_, NSP9_, KSP9_, NCP9_, ZSP9_)							
1.0 GPL	51	01/06 →	FCP4081	Advics			
1.0 VVT-i	51	08/05 →	FCP4081	Advics			
1.3 4WD	64	08/07 →	FCP4081	Advics			
1.3 VVT-i	64	08/05 →	FCP4081	Advics			
1.3 VVT-i	63	11/05 →	FCP4081	Advics			
1.4 D-4D	66	08/05 →	FCP4081	Advics			
1.5 (NCP91)	80	11/05 →	FCP4081	Advics			
1.8 VVTi	97	11/05 →	FCP4081	Advics			
1.8 VVTi	98	01/07 →	FCP4081	Advics			
Yaris Verso							
1.3 16V	63	09/99 →	FCP1392	AKEBONO			
1.4 D D-4D 16V	55	02/02 →	FCP1392	AKEBONO			
TRIUMPH							
TR4/TR5							
2.2	74	01/62 → 12/69			FCP815	LUCAS/TRW	
TR6							
2.5		01/69 → 12/72			FCP815	LUCAS/TRW	
TVR							
Cerbera							
3.9 16V	176	06/96 →	FCP206	ATE			
3.9 16V	176	06/96 →			FCP408	LUCAS/TRW	
Chimaera							
5.0 16V	240	06/96 →	FCP206	ATE			
5.0 16V	240	06/96 →			FCP408	LUCAS/TRW	
Griffith							
4.3 16V	198	10/93 → 10/94	FCP206	ATE			
4.3 16V	198	10/93 → 10/94			FCP408	LUCAS/TRW	
5.0 16V	240	10/93 →	FCP206	ATE			
5.0 16V	240	10/93 →			FCP408	LUCAS/TRW	

For material availability see page 16-18 / Per la disponibilità materiali vedere a pagina 16-18

1220

FERODO

RACING

Updated on 17th Aug 2018



KW



VAUXHALL

Astra

						NOTE			NOTE
1.2	44	09/81 → 08/91	FCP173	GM					
1.3	51, 55	09/81 → 08/91	FCP173	GM					
1.3	51, 55	10/84 → 08/91	FCP173	GM					
1.4	44, 55	10/89 → 08/91	FCP173	GM					
1.4 Saloon/SW Estate	44, 60	09/91 → 02/98	FCP732	ATE					
1.4 Saloon/SW Estate	44, 60	09/91 → 02/98	FCP584	ATE	ABS				
1.6	66	10/84 → 08/91	FCP173	GM					
1.6	52	02/92 → 02/98	FCP584	ATE	ABS				
1.6	52	02/92 → 02/98	FCP732	ATE					
1.6	55	02/92 → 02/98	FCP584	ATE	ABS				
1.6	55	02/92 → 02/98	FCP732	ATE					
1.6	74	02/92 → 02/98	FCP584	ATE	ABS				
1.6	74	02/92 → 02/98	FCP732	ATE					
1.7 D	42	01/89 → 08/91	FCP173	GM					
1.7 TD		09/91 → 02/98	FCP732	ATE					
1.7 TD		09/91 → 02/98	FCP584	ATE	ABS				
1.8		01/92 → 12/98	FCP173	GM					
1.8	81, 85	10/84 → 09/91	FCP173	GM					
1.8	85	01/80 → 10/84	FCP173	GM					
1.8 Cabrio 16V	85	01/97 → 02/98	FCP584	ATE					
1.8 Cabrio 16V	85	01/97 → 02/98				FCP586	ATE		
2.0 GTE	90	03/87 → 08/91	FCP173	GM					
2.0 GTE 16V	110	05/88 → 08/91	FCP584	ATE					
2.0 GTE 16V	110	05/88 → 08/91				FCP586	ATE		
2.0 i GSi 16V	110	09/91 → 02/98	FCP584	ATE					
2.0 i SRi	85	09/91 → 02/98	FCP584	ATE					

Astra (F48)

2.0 DTi	74	09/00 → 03/05	FCP1520	ATE					
---------	----	---------------	---------	-----	--	--	--	--	--

ASTRA (L48)

2.0 VXR	177	11/05 → 05/09	FCP1520	ATE					
---------	-----	---------------	---------	-----	--	--	--	--	--

ASTRA Mk IV (G)

1.2 i 16V	44	02/98 → 03/04	FCP1293	ATE					
1.2 i 16V	44	02/98 → 03/04				FCP1294	BOSCH		
1.6	55	03/98 → 03/04	FCP1293	ATE					
1.6	55	03/98 → 03/04				FCP1294	BOSCH		
1.6	52	03/98 → 03/04	FCP1293	ATE					
1.6	52	03/98 → 03/04				FCP1294	BOSCH		
1.8 16V	85	03/98 → 03/04	FCP1295	ATE	ABS				
1.8 16V	85	03/98 → 03/04				FCP1294	BOSCH		
2.0 16V	85	03/98 → 03/04	FCP1295	ATE	ABS				
2.0 16V	85	03/98 → 03/04				FCP1294	BOSCH		
2.0 TDi 16V	74	03/98 → 03/04	FCP1295	ATE	ABS				
2.0 TDi 16V	74	03/98 → 03/04				FCP1294	BOSCH		

ASTRA Mk IV (G) Convertible

1.6 16V	74	03/98 → 03/04	FCP1293	ATE					
1.6 16V	74	03/98 → 03/04				FCP1294	BOSCH		
1.6 16V	74	03/01 → 10/05	FCP1293	ATE					
1.6 16V	74	03/01 → 10/05				FCP1521	LUCAS/TRW		
1.6 16V	76	03/03 → 10/05	FCP1293	ATE					
1.6 16V	76	03/03 → 10/05				FCP1521	LUCAS/TRW		
1.8 16V	92	03/01 → 10/05	FCP1293	ATE	256mm disc				
1.8 16V	92	03/01 → 10/05	FCP1295	ATE	280mm disc				
1.8 16V	92	03/01 → 10/05				FCP1521	LUCAS/TRW		
2.0	147	09/02 → 07/06	FCP1068	ATE					
2.0	147	09/02 → 07/06				FCP1521	LUCAS/TRW		
2.0 Turbo	141	03/02 → 10/05	FCP1068	ATE					
2.0 Turbo	141	03/02 → 10/05				FCP1521	LUCAS/TRW		
2.2 16V	108	03/01 → 10/05	FCP1295	ATE					
2.2 16V	108	03/01 → 10/05				FCP1521	LUCAS/TRW		

ASTRA Mk IV (G) Coupe (F67)

1.6 16V	76	03/00 → 08/05	FCP1293	ATE					
1.6 16V	76	03/00 → 08/05				FCP1521	LUCAS/TRW		
1.8 16V	92	09/00 → 08/05	FCP1293	ATE	256mm disc				
1.8 16V	92	09/00 → 08/05	FCP1295	ATE	280mm disc				
1.8 16V	92	09/00 → 08/05				FCP1521	LUCAS/TRW		
2.0	147	08/02 → 05/05	FCP1068	ATE					
2.0	147	08/02 → 05/05				FCP1521	LUCAS/TRW		
2.0 16V Turbo	140	09/00 → 08/05	FCP1293	ATE	256mm disc				
2.0 16V Turbo	140	09/00 → 08/05	FCP1295	ATE	280mm disc				
2.0 16V Turbo	140	09/00 → 08/05				FCP1521	LUCAS/TRW		
2.2 16V	108	03/00 → 08/05	FCP1295	ATE					

For material availability see page 16-18 / Per la disponibilità materiali vedere a pagina 16-18

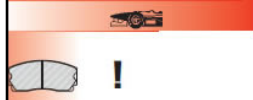

KW

**...VAUXHALL****...ASTRA Mk IV (G) Coupe (F67)**

2.2 16V 108 03/00 → 08/05

FCP1521 LUCAS/TRW

ASTRA Mk IV (G) Estate

1.4 16V 66 02/98 → 05/05

FCP1293 ATE

FCP1521 LUCAS/TRW

1.4 16V 66 02/98 → 05/05

FCP1293 ATE

FCP1521 LUCAS/TRW

1.4 16V 66 03/98 → 03/04

FCP1293 ATE

FCP1294 BOSCH

1.4 16V 66 03/98 → 03/04

FCP1293 ATE

FCP1294 BOSCH

1.6 76 12/02 → 05/05

FCP1293 ATE

FCP1521 LUCAS/TRW

1.6 76 12/02 → 05/05

FCP1293 ATE

FCP1521 LUCAS/TRW

1.7 CDTI 16V 59 04/03 → 05/05

FCP1293 ATE

FCP1521 LUCAS/TRW

1.7 CDTI 16V 59 04/03 → 05/05

FCP1293 ATE

FCP1521 LUCAS/TRW

2.2 16V 108 03/01 → 05/05

FCP1295 ATE

FCP1521 LUCAS/TRW

2.2 16V 108 03/01 → 05/05

FCP1295 ATE

FCP1521 LUCAS/TRW

ASTRA Mk IV (G) Hatchback

1.7 CDTI 16V 59 04/03 → 05/05

FCP1293 ATE

FCP1521 LUCAS/TRW

1.7 CDTI 16V 59 04/03 → 05/05

FCP1293 ATE

FCP1521 LUCAS/TRW

1.8 16V 92 09/00 → 05/05

FCP1293 ATE

256mm disc

FCP1521 LUCAS/TRW

1.8 16V 92 09/00 → 05/05

FCP1295 ATE

280mm disc

FCP1521 LUCAS/TRW

1.8 16V 92 09/00 → 05/05

FCP1293 ATE

256mm disc

FCP1521 LUCAS/TRW

1.8 16V Dualfuel 87 09/02 → 05/05

FCP1295 ATE

280mm disc

FCP1521 LUCAS/TRW

1.8 16V Dualfuel 87 09/02 → 05/05

FCP1295 ATE

280mm disc

FCP1521 LUCAS/TRW

2.0 118 10/99 → 08/00

FCP1068 ATE

FCP1521 LUCAS/TRW

2.0 118 10/99 → 08/00

FCP1068 ATE

FCP1521 LUCAS/TRW

2.0 SRI Turbo 141 07/02 → 05/05

FCP1295 ATE

FCP1521 LUCAS/TRW

2.0 SRI Turbo 141 07/02 → 05/05

FCP1295 ATE

FCP1521 LUCAS/TRW

2.2 16V 108 03/01 → 05/05

FCP1295 ATE

FCP1521 LUCAS/TRW

2.2 16V 108 03/01 → 05/05

FCP1295 ATE

FCP1521 LUCAS/TRW

ASTRA Mk IV (G) Saloon

1.4 44 05/98 → 05/05

FCP1293 ATE

FCP1521 LUCAS/TRW

1.4 44 05/98 → 05/05

FCP1293 ATE

FCP1521 LUCAS/TRW

2.2 16V 108 03/01 → 05/05

FCP1295 ATE

FCP1521 LUCAS/TRW

2.2 16V 108 03/01 → 05/05

FCP1295 ATE

FCP1521 LUCAS/TRW

2.2 DTI 92 09/02 → 05/05

FCP1295 ATE

FCP1521 LUCAS/TRW

2.2 DTI 92 09/02 → 05/05

FCP1295 ATE

FCP1521 LUCAS/TRW

ASTRA Mk V (H) Estate

1.2 59 08/05 → 10/10

FCP1640 ATE

FCP1521 LUCAS/TRW

1.2 59 08/05 → 10/10

FCP1640 ATE

FCP1521 LUCAS/TRW

1.3 CDTi 66 08/04 → 03/09

FCP1640 ATE

FCP1521 LUCAS/TRW

1.3 CDTi 66 08/04 → 03/09

FCP1640 ATE

FCP1521 LUCAS/TRW

1.4 55 08/04 → 10/10

FCP1640 ATE

FCP1521 LUCAS/TRW

1.4 55 08/04 → 10/10

FCP1640 ATE

FCP1521 LUCAS/TRW

1.4 66 08/04 → 03/09

FCP1640 ATE

FCP1521 LUCAS/TRW

1.4 66 08/04 → 03/09

FCP1640 ATE

FCP1521 LUCAS/TRW

1.6 132 08/04 → 03/09

FCP1640 ATE

FCP1521 LUCAS/TRW

1.6 132 08/04 → 03/09

FCP1640 ATE

FCP1521 LUCAS/TRW

1.6 77 08/04 → 03/09

FCP1640 ATE

FCP1521 LUCAS/TRW

1.6 77 08/04 → 03/09

FCP1640 ATE

FCP1521 LUCAS/TRW

1.6 85 08/04 → 03/09

FCP1640 ATE

FCP1521 LUCAS/TRW

1.6 85 08/04 → 03/09

FCP1640 ATE

FCP1521 LUCAS/TRW

1.7 CDTI 59 03/04 → 05/09

FCP1640 ATE

FCP1521 LUCAS/TRW

1.7 CDTi 74 08/04 → 03/09

FCP1640 ATE

FCP1521 LUCAS/TRW

1.7 CDTi 74 08/04 → 03/09

FCP1640 ATE

FCP1521 LUCAS/TRW

1.7 CDTi 81 08/04 → 03/09

FCP1640 ATE

FCP1521 LUCAS/TRW

1.7 CDTi 81 08/04 → 03/09

FCP1640 ATE

FCP1521 LUCAS/TRW

1.7 CDTi 92 02/07 → 10/10

FCP1640 ATE

FCP1521 LUCAS/TRW

1.7 CDTi 92 02/07 → 10/10

FCP1640 ATE

FCP1521 LUCAS/TRW

1.7 TD 79 08/04 → 03/09

FCP1640 ATE

FCP1521 LUCAS/TRW

1.7 TD 79 08/04 → 03/09

FCP1640 ATE

FCP1521 LUCAS/TRW

1.8 103 10/04 → 03/09

FCP1640 ATE

FCP1521 LUCAS/TRW

1.8 103 10/04 → 03/09

FCP1640 ATE

FCP1521 LUCAS/TRW

1.8 92 10/04 → 03/09

FCP1640 ATE

FCP1521 LUCAS/TRW

1.8 92 10/04 → 03/09

FCP1640 ATE

FCP1521 LUCAS/TRW

1.9 CDTi 110 08/04 → 03/09

FCP1640 ATE

FCP1521 LUCAS/TRW

1.9 CDTi 110 08/04 → 03/09

FCP1640 ATE

FCP1521 LUCAS/TRW

1.9 CDTi 74 08/04 → 03/09

FCP1640 ATE

FCP1521 LUCAS/TRW

1.9 CDTi 74 08/04 → 03/09

FCP1640 ATE

FCP1521 LUCAS/TRW

1.9 CDTi 88 08/04 → 03/09

FCP1640 ATE

FCP1521 LUCAS/TRW

1.9 CDTi 88 08/04 → 03/09

FCP1640 ATE

FCP1521 LUCAS/TRW

2.0 Turbo 125 08/04 → 10/10

FCP1640 ATE

FCP1521 LUCAS/TRW

2.0 Turbo 125 08/04 → 10/10

FCP1640 ATE

FCP1521 LUCAS/TRW

2.0 Turbo 147 08/04 → 10/10

FCP1640 ATE

FCP1521 LUCAS/TRW

2.0 Turbo 147 08/04 → 10/10

FCP1640 ATE

FCP1521 LUCAS/TRW

For material availability see page 16-18 / Per la disponibilità materiali vedere a pagina 16-18

1222

FERODO

RACING

Updated on 17th Aug 2018

VAUXHALL

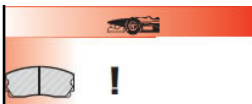

KW

**...VAUXHALL****ASTRA Mk V (H) Hatchback**

					NOTE			NOTE
1.2	59	08/05 → 05/09	FCP1640	ATE				
1.2	59	08/05 → 05/09	FCP1640	ATE		FCP1521	LUCAS/TRW	
1.3 CDTI	66	01/04 → 05/09	FCP1640	ATE				
1.3 CDTI	66	01/04 → 05/09	FCP1640	ATE		FCP1521	LUCAS/TRW	
1.4	55	04/04 → 12/05	FCP1640	ATE				
1.4	55	04/04 → 12/05	FCP1640	ATE		FCP1521	LUCAS/TRW	
1.4	66	01/04 → 05/09	FCP1640	ATE				
1.4	66	01/04 → 05/09	FCP1640	ATE		FCP1521	LUCAS/TRW	
1.6	77	01/04 → 05/09	FCP1640	ATE				
1.6	77	01/04 → 05/09	FCP1640	ATE		FCP1521	LUCAS/TRW	
1.6	85	01/04 → 05/09	FCP1640	ATE				
1.6	85	01/04 → 05/09	FCP1640	ATE		FCP1521	LUCAS/TRW	
1.6 Turbo	132	09/06 →	FCP1640	ATE				
1.7 CDTI	59	01/04 → 05/09	FCP1640	ATE				
1.7 CDTI	59	01/04 → 05/09	FCP1640	ATE		FCP1521	LUCAS/TRW	
1.7 CDTI	74	01/04 → 05/09	FCP1640	ATE				
1.7 CDTI	74	01/04 → 05/09	FCP1640	ATE		FCP1521	LUCAS/TRW	
1.7 CDTi	81	01/04 → 05/09	FCP1640	ATE				
1.7 CDTi	81	01/04 → 05/09	FCP1640	ATE		FCP1521	LUCAS/TRW	
1.7 CDTI	92	02/07 → 09/09	FCP1640	ATE				
1.7 TD	79	01/04 → 05/09	FCP1640	ATE				
1.7 TD	79	01/04 → 05/09	FCP1640	ATE		FCP1521	LUCAS/TRW	
1.8	103	01/04 → 05/09	FCP1640	ATE				
1.8	103	01/04 → 05/09	FCP1640	ATE		FCP1521	LUCAS/TRW	
1.8	92	01/04 → 05/09	FCP1640	ATE				
1.8	92	01/04 → 05/09	FCP1640	ATE		FCP1521	LUCAS/TRW	
1.9 CDTI	110	01/04 → 05/09	FCP1640	ATE				
1.9 CDTI	110	01/04 → 05/09	FCP1640	ATE		FCP1521	LUCAS/TRW	
1.9 CDTI	88	01/04 → 05/09	FCP1640	ATE				
1.9 CDTI	88	01/04 → 05/09	FCP1640	ATE		FCP1521	LUCAS/TRW	
1.9 CDTI 16V	88	01/04 → 05/09	FCP1640	ATE				
1.9 CDTI 16V	88	01/04 → 05/09	FCP1640	ATE		FCP1521	LUCAS/TRW	
2.0 Turbo	125	01/04 → 05/09	FCP1640	ATE				
2.0 Turbo	125	01/04 → 05/09	FCP1640	ATE		FCP1521	LUCAS/TRW	
2.0 Turbo	147	01/04 → 05/09	FCP1640	ATE				
2.0 Turbo	147	01/04 → 05/09	FCP1640	ATE		FCP1521	LUCAS/TRW	
2.0 Turbo	177	01/04 → 05/09	FCP1640	ATE				
2.0 Turbo	177	01/04 → 05/09	FCP1640	ATE		FCP1521	LUCAS/TRW	

ASTRA Mk V (H) Sport Hatch

1.3 CDTi	66	04/05 → 11/10	FCP1640	ATE				
1.3 CDTi	66	04/05 → 11/10	FCP1640	ATE		FCP1521	LUCAS/TRW	
1.4	55	02/05 → 11/10	FCP1640	ATE				
1.4	55	02/05 → 11/10	FCP1640	ATE		FCP1521	LUCAS/TRW	
1.4 i 16V	66	03/05 → 11/10	FCP1640	ATE				
1.4 i 16V	66	03/05 → 11/10	FCP1640	ATE		FCP1521	LUCAS/TRW	
1.6	132	10/06 → 11/10	FCP1640	ATE				
1.6	132	10/06 → 11/10	FCP1640	ATE		FCP1521	LUCAS/TRW	
1.6	77	02/05 → 11/10	FCP1640	ATE				
1.6	77	02/05 → 11/10	FCP1640	ATE		FCP1521	LUCAS/TRW	
1.6 i 16V	85	12/06 → 11/10	FCP1640	ATE				
1.6 i 16V	85	12/06 → 11/10	FCP1640	ATE		FCP1521	LUCAS/TRW	
1.7 CDTi	74	02/05 → 11/10	FCP1640	ATE				
1.7 CDTi	74	02/05 → 11/10	FCP1640	ATE		FCP1521	LUCAS/TRW	
1.7 CDTi	81	02/07 → 11/10	FCP1640	ATE				
1.7 CDTi	81	02/07 → 11/10	FCP1640	ATE		FCP1521	LUCAS/TRW	
1.7 CDTI	92	02/07 →	FCP1640	ATE				
1.8	92	02/05 → 11/10	FCP1640	ATE				
1.8	92	02/05 → 11/10	FCP1640	ATE		FCP1521	LUCAS/TRW	
1.8 i 16V	103	03/07 → 11/10	FCP1640	ATE				
1.8 i 16V	103	03/07 → 11/10	FCP1640	ATE		FCP1521	LUCAS/TRW	
1.9 CDTi	110	02/05 → 11/10	FCP1640	ATE				
1.9 CDTi	110	02/05 → 11/10	FCP1640	ATE		FCP1521	LUCAS/TRW	
1.9 CDTi	74	08/05 → 11/10	FCP1640	ATE				
1.9 CDTi	74	08/05 → 11/10	FCP1640	ATE		FCP1521	LUCAS/TRW	
1.9 CDTi	88	02/05 → 11/10	FCP1640	ATE				
1.9 CDTi	88	02/05 → 11/10	FCP1640	ATE		FCP1521	LUCAS/TRW	
2.0 Turbo	125	02/05 → 11/10	FCP1640	ATE				
2.0 Turbo	125	02/05 → 11/10	FCP1640	ATE		FCP1521	LUCAS/TRW	
2.0 VXR	176	02/09 → 11/10	FCP1520	ATE				
2.0 VXR	176	02/09 → 11/10	FCP1520	ATE		FCP1521	LUCAS/TRW	

For material availability see page 16-18 / Per la disponibilità materiali vedere a pagina 16-18



KW



...VAUXHALL

ASTRA Mk VI (J) (P10)

						NOTE			NOTE
1.3 CDTI	70	12/09 →	FCP4262	MANDO					
1.4	64	12/09 →	FCP4262	MANDO					
1.4	74	12/09 → 12/16	FCP4262	MANDO					
1.4 Turbo	103	12/09 →	FCP4262	MANDO					
1.4 Turbo	88	08/11 →	FCP4262	MANDO	Disc Diam mm:276				
1.6	85	12/09 →	FCP4262	MANDO	Disc Diam mm:276				
1.7 CDTI	74	10/10 →	FCP4262	MANDO	Disc Diam mm:276				

ASTRA Mk VI (J) Estate (P10)

1.3 CDTi	70	10/10 →	FCP4262	MANDO	Disc Diam mm:276				
1.4	64	10/10 →	FCP4262	MANDO	Disc Diam mm:276				
1.4	74	10/10 → 12/16	FCP4262	MANDO					
1.4 Turbo	103	10/10 →	FCP4262	MANDO					
1.4 Turbo	88	10/10 →	FCP4262	MANDO					
1.6	85	10/10 →	FCP4262	MANDO	Disc Diam mm:276				

ASTRA Mk VI (J) Saloon (P10)

1.3 CDTI	70	06/12 →	FCP4262	MANDO	Disc Diam mm:276				
1.4	74	06/12 →	FCP4262	MANDO	Disc Diam mm:276				
1.4 Turbo	103	06/12 →	FCP4262	MANDO	Disc Diam mm:276				
1.6	85	06/12 →	FCP4262	MANDO	Disc Diam mm:276				

ASTRA Mk VI (J) Sports Tourer

1.4	64	12/09 →	FCP4262	MANDO					
-----	----	---------	---------	-------	--	--	--	--	--

ASTRA TwinTop Mk V (H)

1.6	132	10/06 → 11/10	FCP1640	ATE					
1.6	132	10/06 → 11/10				FCP1521	LUCAS/TRW		
1.6	77	09/05 → 11/10	FCP1640	ATE					
1.6	77	09/05 → 11/10				FCP1521	LUCAS/TRW		
1.6 i 16V	85	10/06 → 11/10	FCP1640	ATE					
1.6 i 16V	85	10/06 → 11/10				FCP1521	LUCAS/TRW		
1.8	103	05/08 → 11/10	FCP1640	ATE					
1.8	103	05/08 → 11/10				FCP1521	LUCAS/TRW		
1.8	92	09/05 → 11/10	FCP1640	ATE					
1.9 CDTi	110	01/06 → 11/10	FCP1640	ATE					
1.9 CDTi	110	01/06 → 11/10				FCP1521	LUCAS/TRW		
2.0	125	02/06 → 11/10	FCP1640	ATE					
2.0	125	02/06 → 11/10				FCP1521	LUCAS/TRW		
2.0 Turbo	147	01/06 → 11/10	FCP1640	ATE					
2.0 Turbo	147	01/06 → 11/10				FCP1521	LUCAS/TRW		

Astramax

1.4	44	11/91 → 03/04	FCP732	ATE					
1.4	44, 55	09/85 → 10/91	FCP173	GM					
1.6		11/91 → 03/04	FCP732	ATE					
1.6 D	40, 42	09/85 → 10/91	FCP173	GM					
1.7 D	42, 44	11/91 → 03/04	FCP732	ATE					
1.7 D 365	42, 44	09/85 → 10/91	FCP173	GM					

ASTRAVAN

1.3	51, 55	07/82 → 09/84	FCP173	GM					
1.3	34	10/84 → 10/89	FCP173	GM					
1.3	44	10/84 → 10/89	FCP173	GM					
1.3	55	10/84 → 10/89	FCP173	GM					
1.4	44	09/89 → 10/91	FCP173	GM					
1.4	44	11/91 → 03/04	FCP732	ATE					
1.4 i	44	06/90 → 10/91	FCP173	GM					
1.6	52, 55	11/91 → 08/95	FCP732	ATE					
1.6	66	10/84 → 10/91	FCP173	GM					
1.7 D	42	01/89 → 10/91	FCP173	GM					

ASTRAVAN Mk III (F) (T92)

1.7 D	44	01/91 → 08/94	FCP732	ATE					
1.7 TD	50	01/94 → 08/98	FCP732	ATE					

ASTRAVAN Mk IV (G)

1.7 CDTI	59	04/04 → 08/06	FCP1640	ATE					
1.7 CDTI	59	04/04 → 08/06				FCP1521	LUCAS/TRW		
1.7 DTI 16V	55	04/01 → 08/06	FCP1293	ATE					
1.7 DTI 16V	55	04/01 → 08/06				FCP1521	LUCAS/TRW		
1.7 TD	50	03/98 → 03/04	FCP1293	ATE					
1.7 TD	50	03/98 → 03/04				FCP1294	BOSCH		
1.7 TD	50	08/98 → 08/06	FCP1293	ATE					
1.7 TD	50	08/98 → 08/06				FCP1521	LUCAS/TRW		
2.0 DI	60	08/98 → 08/06	FCP1293	ATE	256mm disc				

For material availability see page 16-18 / Per la disponibilità materiali vedere a pagina 16-18

1224

FERODO

RACING

Updated on 17th Aug 2018

VAUXHALL



KW



...VAUXHALL					NOTE			NOTE
...ASTRAVAN Mk IV (G)								
2.0 DI	60	08/98 → 08/06	FCP1295	ATE	280mm disc			
2.0 DI	60	08/98 → 08/06				FCP1521	LUCAS/TRW	
2.0 DTI	74	04/04 → 08/06	FCP1640	ATE				
2.0 DTI	74	04/04 → 08/06				FCP1521	LUCAS/TRW	
ASTRAVAN Mk V (H)								
1.3 CDTi	66	08/05 →	FCP1640	ATE				
1.3 CDTi	66	08/05 →				FCP1521	LUCAS/TRW	
1.4 i	66	03/05 →	FCP1640	ATE				
1.4 i	66	03/05 →				FCP1521	LUCAS/TRW	
1.6	76	03/05 →	FCP1640	ATE				
1.6	76	03/05 →				FCP1521	LUCAS/TRW	
1.7 CDTi	59	03/05 → 07/06	FCP1640	ATE				
1.7 CDTi	59	03/05 → 07/06				FCP1521	LUCAS/TRW	
1.7 CDTi	74	03/05 → 11/11	FCP1640	ATE				
1.7 CDTi	74	03/05 → 11/11				FCP1521	LUCAS/TRW	
1.7 CDTi	81	06/11 → 12/13	FCP4262	MANDO				
1.7 CDTi	92	11/11 →	FCP4262	MANDO				
1.9 CDTi	110	03/05 → 11/11	FCP1640	ATE				
1.9 CDTi	110	03/05 → 11/11				FCP1521	LUCAS/TRW	
1.9 CDTi	88	03/05 → 11/11	FCP1640	ATE				
1.9 CDTi	88	03/05 → 11/11				FCP1521	LUCAS/TRW	
Belmont								
1.3	55	01/86 → 10/89	FCP173	GM				
1.4	55	10/89 → 06/92	FCP173	GM				
1.6	66	01/86 → 06/92	FCP173	GM				
1.7 D	42	01/89 → 06/92	FCP173	GM				
1.8	85	01/86 → 06/92	FCP173	GM				
Calibra								
2.0	85	09/89 → 12/96	FCP584	ATE				
2.0	85	09/89 → 12/96				FCP586	ATE	
2.0 (Turbo) 16V	150	09/89 → 12/96	FCP685	ATE				
2.0 (Turbo) 16V	150	09/89 → 12/96				FCP586	ATE	
2.5 24V	125	09/89 → 12/96	FCP584	ATE				
2.5 24V	125	09/89 → 12/96				FCP586	ATE	
Carlton								
1.8	55, 66	01/79 → 12/83	FCP173	GM				
1.8	55, 66	01/79 → 12/83	FCP116	ATE				
1.8	55	01/84 → 10/86	FCP173	GM				
1.8	60	01/89 → 08/92	FCP584	ATE				
1.8	65	01/84 → 10/86	FCP173	GM				
1.8	66	01/84 → 10/86	FCP173	GM				
1.8	66	01/89 → 08/92	FCP584	ATE				
1.8	85	01/89 → 08/92	FCP584	ATE				
2.0	81	07/83 → 10/86	FCP173	GM				
2.0	85	01/89 → 04/94	FCP584	ATE				
2.0	85, 90	11/86 → 12/88	FCP173	GM				
2.0	66	01/79 → 12/83	FCP173	GM				
2.0	66	01/79 → 12/83	FCP116	ATE				
2.0	74	01/79 → 12/83	FCP173	GM				
2.0	74	01/79 → 12/83	FCP116	ATE				
2.0	81	01/79 → 12/83	FCP173	GM				
2.0	81	01/79 → 12/83	FCP116	ATE				
2.2	85	08/84 → 08/86	FCP173	GM				
2.3 D		01/84 → 12/88	FCP173	GM				
2.3 D	48	01/79 → 12/88	FCP173	GM				
2.3 TD		11/86 → 12/88	FCP173	GM				
2.3 TD		01/89 → 04/94	FCP584	ATE				
2.6	110	09/90 → 04/94	FCP584	ATE				
3.0 24V	150	03/87 → 12/88	FCP173	GM				
3.0 24V	150	01/89 → 12/90	FCP584	ATE				
3.6 Lotus 24V	280	09/90 → 04/94				FCP825	LOCKHEED	
CARLTON Mk III (V87)								
1.8	65	09/87 → 03/94	FCP173	GM				
1.8 i	85	09/86 → 03/94	FCP173	GM				
1.8 N	60	09/86 → 08/87	FCP173	GM				
1.8 S	66	09/86 → 03/94	FCP173	GM				

VAUXHALL

For material availability see page 16-18 / Per la disponibilità materiali vedere a pagina 16-18



KW

**...VAUXHALL**

NOTE

NOTE

CARLTON Mk III Estate (V87)

1.8	65	09/87 → 03/94	FCP173	GM		
1.8 i	85	09/86 → 03/94	FCP173	GM		
1.8 N	60	09/86 → 08/87	FCP173	GM		
1.8 S	66	09/86 → 03/94	FCP173	GM		

Cavalier

1.3	42	01/78 → 09/78	FCP116	ATE		
1.3	42	10/78 → 07/81	FCP173	GM		
1.3	44, 55	08/81 → 08/88	FCP173	GM		
1.4	55	10/88 → 09/91	FCP173	GM		
1.4	55	09/91 → 08/92	FCP732	ATE		
1.6		01/84 → 09/91	FCP173	GM		
1.6	55	01/75 → 09/78	FCP116	ATE		
1.6	55	10/78 → 07/81	FCP173	GM		
1.6	66	08/81 → 12/83	FCP173	GM		
1.6	52	09/91 → 12/95	FCP732	ATE		
1.6	55	09/91 → 12/95	FCP732	ATE		
1.6	60	09/91 → 12/95	FCP732	ATE		
1.6 D SW Estate	40	01/84 → 12/85	FCP173	GM		
1.6 D SW Estate	40, 42	01/85 → 08/88	FCP173	GM		
1.7 D	42	09/88 → 09/91	FCP173	GM		
1.7 D	42	10/91 → 12/95	FCP732	ATE		
1.7 D	42	10/91 → 12/95	FCP732	ATE		
1.7 D	44	10/91 → 12/95	FCP732	ATE		
1.7 D	60	10/91 → 12/95	FCP732	ATE		
1.7 TD	60	10/91 → 12/95	FCP732	ATE		
1.8	65, 66	10/89 → 09/91	FCP173	GM		
1.8	65, 66	10/91 → 12/95	FCP732	ATE		
1.8	68	10/82 → 12/83	FCP173	GM		
1.8	68, 85	01/84 → 08/88	FCP173	GM		
1.9	62	01/75 → 12/78	FCP116	ATE		
2.0		10/88 → 12/95	FCP584	ATE		
2.0		10/88 → 12/95			FCP586	ATE
2.0	74	01/78 → 09/78	FCP116	ATE		
2.0	74	10/78 → 07/81	FCP173	GM		
2.0	102	08/86 → 10/88	FCP173	GM		
2.0	110	08/86 → 10/88	FCP173	GM		
2.0	92	08/86 → 10/88	FCP173	GM		
2.0	95	08/86 → 10/88	FCP173	GM		
2.0 4x4	85, 95	01/89 → 12/92	FCP584	ATE		
2.0 4x4	85, 95	01/89 → 12/92			FCP586	ATE
2.0 4x4 (Turbo) 16V	150	10/92 → 12/95	FCP685	ATE		
2.0 4x4 (Turbo) 16V	150	10/92 → 12/95			FCP586	ATE
2.0 i		01/92 → 12/95	FCP584	ATE		
2.0 i		01/92 → 12/95			FCP586	ATE
2.5 24V	125	05/93 → 12/95	FCP584	ATE		
2.5 24V	125	05/93 → 12/95	FCP685	ATE		
2.5 24V	125	05/93 → 12/95	FCP1068	ATE		
2.5 24V	125	05/93 → 12/95			FCP586	ATE

Chevanne

1.3	39, 42	01/76 → 12/82	FCP2	ATE		
-----	--------	---------------	------	-----	--	--

Chevette

1.2	33	01/75 → 12/84	FCP2	ATE		
1.2	33	01/75 → 12/84	FCP116	ATE		
1.3	37	01/75 → 12/84	FCP2	ATE		
1.3	37	01/75 → 12/84	FCP116	ATE		
1.3	39	01/75 → 12/84	FCP2	ATE		
1.3	39	01/75 → 12/84	FCP116	ATE		
1.3	42	01/75 → 12/84	FCP2	ATE		
1.3	42	01/75 → 12/84	FCP116	ATE		
2.3 HS	80	01/77 → 12/83	FCP116	ATE		

COMBO

1.4	44	10/91 →	FCP732	ATE		
1.6		10/91 →	FCP732	ATE		
1.7 D	44	10/91 →	FCP732	ATE		

COMBO Mk II (C) Box Body / Estate (F25)

1.3 CDTI 16V	51	09/04 → 02/12	FCP1640	ATE		
1.3 CDTI 16V	51	09/04 → 02/12			FCP1521	LUCAS/TRW
1.3 i 16V	55	10/05 → 11/11	FCP1424	LUCAS/TRW		
1.3 i 16V	55	10/05 → 11/11	FCP1640	ATE		
1.3 i 16V	55	10/05 → 11/11			FCP1521	LUCAS/TRW
1.4 16V	66	09/00 →	FCP1424	LUCAS/TRW		

For material availability see page 16-18 / Per la disponibilità materiali vedere a pagina 16-18

1226

FERODO

RACING

Updated on 17th Aug 2018

VAUXHALL



KW



...VAUXHALL					NOTE			NOTE
...COMBO Mk II (C) Box Body / Estate (F25)								
1.4 16V	66	10/01 → 05/07	FCP1640	ATE				
1.4 16V	66	10/01 → 05/07				FCP1521	LUCAS/TRW	
1.4 i 16V	66	01/04 → 11/11	FCP1640	ATE				
1.4 i 16V	66	01/04 → 11/11				FCP1521	LUCAS/TRW	
1.6	62	08/01 → 10/04	FCP1640	ATE				
1.6	62	08/01 → 10/04				FCP1521	LUCAS/TRW	
1.6	64	10/01 → 11/11	FCP1640	ATE				
1.6	64	10/01 → 11/11				FCP1521	LUCAS/TRW	
1.6 CNG 16V	69	06/06 → 02/12	FCP1640	ATE				
1.6 CNG 16V	69	06/06 → 02/12				FCP1521	LUCAS/TRW	
1.6 CNG 16V	71	04/05 → 02/12	FCP1640	ATE				
1.6 CNG 16V	71	04/05 → 02/12				FCP1521	LUCAS/TRW	
1.7 CDTI 16V	74	12/04 → 11/11	FCP1640	ATE				
1.7 CDTI 16V	74	12/04 → 11/11				FCP1521	LUCAS/TRW	
1.7 Di	48	09/00 →	FCP1424	LUCAS/TRW				
1.7 Di	48	09/01 → 11/11	FCP1640	ATE				
1.7 Di	48	09/01 → 11/11				FCP1521	LUCAS/TRW	
1.7 DTi	55	09/00 →	FCP1424	LUCAS/TRW				
1.7 DTi	55	09/00 → 11/11	FCP1424	LUCAS/TRW				
1.7 DTi	55	10/01 → 11/11	FCP1640	ATE				
1.7 DTi	55	10/01 → 11/11				FCP1521	LUCAS/TRW	
COMBO TOUR Mk II (C) (F25)								
1.3 CDTI 16V	51	09/04 → 09/06	FCP1640	ATE				
1.3 CDTI 16V	55	07/06 → 02/12	FCP1640	ATE				
1.4	66	10/04 → 09/10	FCP1640	ATE				
1.6	64	10/01 → 06/04	FCP1640	ATE				
1.7 DI 16V	48	09/01 → 06/04	FCP1640	ATE				
1.7 DTI 16V	55	10/01 → 02/12	FCP1640	ATE				
CORSA								
1.0		03/93 → 08/00	FCP732	ATE				
1.2		03/93 → 08/00	FCP732	ATE				
1.4		03/93 → 08/94	FCP732	ATE				
1.4 16V	40, 44	03/93 → 08/94	FCP732	ATE				
1.4 SE		03/93 → 08/00	FCP732	ATE				
1.5 D		03/93 → 08/94	FCP732	ATE				
1.5 TD		03/93 → 08/94	FCP732	ATE				
1.6 Gsi 16V	78	03/93 → 07/94	FCP732	ATE				
1.6 Gsi 16V	80	03/93 → 07/94	FCP732	ATE				
1.6 Gsi 16V	95	03/93 → 07/94	FCP732	ATE				
1.7 D		03/93 → 08/00	FCP732	ATE				
CORSA Mk II (C) (W5L, F08)								
1.0 12V	43	09/00 → 10/03	FCP1424	LUCAS/TRW				
1.0 12V	43	09/00 → 10/03				FCP1521	LUCAS/TRW	
1.2 16V	55	09/00 → 10/06	FCP1424	LUCAS/TRW				
1.2 16V	55	09/00 → 10/06				FCP1521	LUCAS/TRW	
1.3 CDTI 16V	55	09/05 → 09/06	FCP1424	LUCAS/TRW				
1.3 CDTI 16V	55	09/05 → 09/06				FCP1521	LUCAS/TRW	
1.4 i 16V	66	09/00 →	FCP1424	LUCAS/TRW				
1.4 Twinport	66	06/03 → 10/06	FCP1424	LUCAS/TRW				
1.4 Twinport	66	06/03 → 10/06				FCP1521	LUCAS/TRW	
1.7 CDTI 16V	74	08/00 → 09/06	FCP1640	ATE				
1.7 DI 16V	48	08/00 → 09/06	FCP1424	LUCAS/TRW				
1.7 DI 16V	48	08/00 → 09/06				FCP1521	LUCAS/TRW	
1.7 DTI 16V	55	08/00 → 09/06	FCP1424	LUCAS/TRW				
1.7 DTI 16V	55	08/00 → 09/06				FCP1521	LUCAS/TRW	
1.8 i 16V	92	09/00 →	FCP1424	LUCAS/TRW				
CORSA Mk III (D) (L_8)								
1.6 SRi	110	05/07 →	FCP1640	ATE				
1.6 SRi	110	05/07 →				FCP1858	BOSCH	
1.6 VXR	141	02/07 →	FCP1640	ATE				
1.6 VXR	141	02/07 →				FCP1858	BOSCH	
1.6 VXR	150	06/11 → 03/12	FCP1640	ATE				
1.6 VXR	150	06/11 → 03/12				FCP1858	BOSCH	
CORSAVAN								
1.4	44	10/91 →	FCP732	ATE				
1.7	42, 44	10/91 →	FCP732	ATE				

VAUXHALL

For material availability see page 16-18 / Per la disponibilità materiali vedere a pagina 16-18

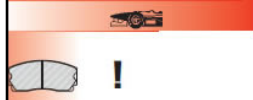

KW

**...VAUXHALL****CORSAVAN Mk II (C)**

1.4	66	11/03 → 06/06	FCP1424	LUCAS/TRW			
1.4	66	11/03 → 06/06				FCP1521	LUCAS/TRW

MERIVA Mk I (A)

1.3 CDTI	51	04/05 → 06/10	FCP1640	ATE			
1.3 CDTI	51	04/05 → 06/10				FCP1521	LUCAS/TRW
1.3 CDTI	55	01/03 → 10/09	FCP1640	ATE	Rims 15"		
1.3 CDTI	55	01/03 → 10/09				FCP1521	LUCAS/TRW
1.4 16V Twinport	66	01/03 → 10/09	FCP1640	ATE	Rims 15"		
1.4 16V Twinport	66	01/03 → 10/09				FCP1521	LUCAS/TRW
1.6 i	64	01/03 → 06/10	FCP1640	ATE	Rims 15"		
1.6 i	64	01/03 → 06/10				FCP1521	LUCAS/TRW
1.6 i 16V	74	01/03 → 09/05	FCP1640	ATE	Rims 15"		
1.6 i 16V	74	01/03 → 09/05				FCP1521	LUCAS/TRW
1.6 i 16V Twinport	77	05/03 → 06/10	FCP1640	ATE	Rims 15"		
1.6 i 16V Twinport	77	05/03 → 06/10				FCP1521	LUCAS/TRW
1.6 Turbo	132	05/06 → 06/10	FCP1640	ATE			
1.6 Turbo	132	05/06 → 06/10				FCP1521	LUCAS/TRW
1.7 CDTI	92	08/06 → 06/10	FCP1640	ATE			
1.7 CDTI	92	08/06 → 06/10				FCP1521	LUCAS/TRW
1.7 CDTI 16V	74	09/03 → 08/05	FCP1640	ATE			
1.7 CDTI 16V	74	09/03 → 08/05				FCP1521	LUCAS/TRW
1.7 DTI 16V	55	06/03 → 06/10	FCP1640	ATE			
1.7 DTI 16V	55	06/03 → 06/10				FCP1521	LUCAS/TRW
1.8 i 16V	92	05/03 → 08/05	FCP1640	ATE			
1.8 i 16V	92	05/03 → 08/05				FCP1521	LUCAS/TRW

MERIVA Mk II (B)

1.3 CDTI	55	06/10 →	FCP1640	ATE			
1.3 CDTI	55	06/10 →				FCP1521	LUCAS/TRW
1.3 CDTi	70	06/10 →	FCP1640	ATE			
1.3 CDTi	70	06/10 →				FCP1521	LUCAS/TRW
1.4	103	06/10 →	FCP1640	ATE			
1.4	103	06/10 →				FCP1521	LUCAS/TRW
1.4	88	06/10 →	FCP1640	ATE			
1.4	88	06/10 →				FCP1521	LUCAS/TRW
1.4	74	06/10 →	FCP1640	ATE			
1.4	74	06/10 →				FCP1521	LUCAS/TRW
1.4 LPG	88	06/11 →	FCP1640	ATE			
1.7 CDTI	74	06/10 →	FCP1640	ATE			
1.7 CDTI	74	06/10 →				FCP1521	LUCAS/TRW
1.7 CDTi	81	06/10 →	FCP1640	ATE			
1.7 CDTi	81	06/10 →				FCP1521	LUCAS/TRW
1.7 CDTi	96	06/10 →	FCP1640	ATE			
1.7 CDTi	96	06/10 →				FCP1521	LUCAS/TRW

Nova

1.0	33	04/83 → 12/91	FCP173	GM			
1.0	33	01/92 → 03/93	FCP732	ATE			
1.0 i	33	01/84 → 12/91	FCP173	GM			
1.2	33	01/92 → 03/93	FCP732	ATE			
1.2	33, 40	04/83 → 12/91	FCP173	GM			
1.2 i	33, 40	01/84 → 12/91	FCP173	GM			
1.3	44, 51	01/84 → 09/89	FCP173	GM			
1.3	51	06/83 → 12/84	FCP173	GM			
1.4	44	10/89 → 12/91	FCP173	GM			
1.4	44	01/92 → 03/93	FCP732	ATE			
1.4	55	10/89 → 12/91	FCP173	GM			
1.4	55	01/92 → 03/93	FCP732	ATE			
1.4	60	10/89 → 12/91	FCP173	GM			
1.4	60	01/92 → 03/93	FCP732	ATE			
1.4 i		11/90 → 12/91	FCP173	GM			
1.5 D	37, 49	09/89 → 12/91	FCP173	GM			
1.5 D	37, 49	01/92 → 03/93	FCP732	ATE			
1.6 GSi, GTE	74	01/92 → 03/93	FCP732	ATE			

NOVA Hatchback (S83)

1.6	60	09/88 → 08/90	FCP173	GM			
1.6 GSi	72	09/89 → 03/93	FCP173	GM			
1.6 GSi	74	05/88 → 03/92	FCP173	GM			

For material availability see page 16-18 / Per la disponibilità materiali vedere a pagina 16-18

1228

FERODO

RACING

Updated on 17th Aug 2018

VAUXHALL



KW



...VAUXHALL

Omega

2.0 16V	100	04/94 →	FCP685	ATE
2.5 V6 24V	125	04/94 →	FCP685	ATE

Royale

2.8	103	01/78 → 12/84	FCP11	ATE
2.8	103	01/78 → 12/84		
3.0	132	01/78 → 12/84	FCP11	ATE
3.0	132	01/78 → 12/84		

Senator

2.5	103	10/84 → 12/85	FCP11	ATE
2.5	103	10/84 → 12/85		
3.0	132	10/84 → 12/85	FCP11	ATE
3.0	132	10/84 → 12/85		

Signum (F48)

1.8	103	08/05 → 03/08	FCP1520	ATE
1.8	90	06/03 → 07/05	FCP1520	ATE
1.8	90	06/03 → 07/05		
1.9	74	01/05 → 05/08	FCP1520	ATE
1.9 CDTi	88	04/04 → 03/08	FCP1520	ATE
1.9 CDTi 16V	110	04/04 → 03/08	FCP1520	ATE
2.0 DTi	74	05/03 → 04/04	FCP1520	ATE
2.0 DTi	74	05/03 → 04/04		
2.0 I Turbo	129	09/03 → 03/08	FCP1520	ATE
2.0 I Turbo	129	09/03 → 03/08		
2.2 DGi	114	06/03 → 03/08	FCP1520	ATE
2.2 DGi	114	06/03 → 03/08		
2.2 DTi	92	05/03 → 04/04	FCP1520	ATE
2.2 DTi	92	05/03 → 04/04		
3.0 CDTi	130	06/03 → 07/05	FCP1520	ATE
3.0 CDTi	130	06/03 → 07/05		
3.2 DGi	155	06/03 → 07/05	FCP1520	ATE
3.2 DGi	155	06/03 → 07/05		

Tigra

1.4 16V	66	09/94 →	FCP732	ATE
1.6 16V	78	09/94 →	FCP732	ATE

Tigra Twin Top

1.3 CDTi 16v	51	06/04 →	FCP1424	LUCAS/TRW
1.4 i 16V	66	06/04 →	FCP1424	LUCAS/TRW
1.8 i 16V	92	06/04 →	FCP1424	LUCAS/TRW

Vectra

2.0 16V	100	10/95 → 04/02	FCP1068	ATE
2.5 V6 24V	125	10/95 → 04/02	FCP1068	ATE

Vectra (F19)

2.6	125	09/00 → 03/02	FCP1520	ATE
-----	-----	---------------	---------	-----

Vectra (F35)

1.6	74	06/04 → 07/08	FCP1520	ATE
1.6	77	10/06 → 08/08	FCP1520	ATE
1.8	103	08/05 → 08/08	FCP1520	ATE
1.8	81	04/02 → 07/08	FCP1520	ATE
1.8	81	04/02 → 07/08		
1.8	90	04/02 → 08/05	FCP1520	ATE
1.8	90	04/02 → 08/05		
1.9 CDTi	110	04/04 → 08/08	FCP1520	ATE
1.9 CDTi	88	04/04 → 08/05	FCP1520	ATE
2.0 DTi	74	04/02 → 08/05	FCP1520	ATE
2.0 DTi	74	04/02 → 08/05		
2.0 Turbo	129	08/03 → 08/08	FCP1520	ATE
2.2 DGi	114	07/03 → 08/08	FCP1520	ATE
2.2 DTi	92	10/03 → 07/08	FCP1520	ATE
2.2 DTi	92	10/03 → 07/08		
2.6	125	09/00 → 03/02	FCP1520	ATE
3.0 CDTi	130	04/02 → 07/05	FCP1520	ATE
3.0 CDTi	130	04/02 → 07/05		
3.2	155	04/02 → 07/05	FCP1520	ATE
3.2	155	04/02 → 07/05		

NOTE

NOTE

VAUXHALL

For material availability see page 16-18 / Per la disponibilità materiali vedere a pagina 16-18



KW



...VAUXHALL

Vectra (F68)

1.6	74	06/04 → 07/08
1.6	77	01/06 → 08/08
1.8	103	08/05 → 08/08
1.8	90	08/02 → 07/08
1.8	90	08/02 → 07/08
1.8 DualFuel	90	08/02 → 07/08
1.9 CDTi	110	04/04 → 08/08
1.9 CDTi	74	08/05 → 08/08
1.9 CDTi	88	04/04 → 08/05
2.0 DTi	74	04/02 → 08/05
2.0 DTi	74	04/02 → 08/05
2.0 Turbo	129	02/03 → 08/08
2.2	108	08/02 → 07/08
2.2	108	08/02 → 07/08
2.2 DGi	114	04/04 → 08/08
2.2 DTi	92	04/02 → 07/08
2.2 DTi	92	04/02 → 07/08
3.2	155	08/02 → 07/05
3.2	155	08/02 → 07/05

Vectra (F69)

1.6	74	04/02 → 09/05
1.6	77	08/05 → 08/08
1.8	103	08/05 → 08/08
1.8	81	04/02 → 07/08
1.8	81	04/02 → 07/08
1.8 DualFuel	90	04/02 → 07/08
1.8 DualFuel	90	04/02 → 07/08
1.8 DualFuel	90	04/02 → 07/08
1.9 CDTi	110	04/04 → 08/08
1.9 CDTi	74	10/05 → 07/08
1.9 CDTi	88	04/04 → 09/08
2.0 DTi	74	04/02 → 08/05
2.0 DTi	74	04/02 → 08/05
2.0 Turbo	129	02/03 → 08/08
2.2	108	01/02 → 10/08
2.2	108	01/02 → 10/08
2.2 DGi	114	04/04 → 08/08
2.2 DTi	92	04/02 → 03/04
2.2 DTi	92	04/02 → 03/04
3.2	155	08/02 → 07/05
3.2	155	08/02 → 07/05

Viceroy

2.5 24V	125	01/80 → 12/84
---------	-----	---------------

Viva

1.8 1800		01/72 → 12/78	FCP810	LUCAS/TRW
1.8 i 1800		01/73 → 12/78	FCP810	LUCAS/TRW
2.3 2300		01/72 → 12/78	FCP810	LUCAS/TRW
2.3 i 2300		01/73 → 12/78	FCP810	LUCAS/TRW

VX220

2.2 2.2i	108	10/00 →	FCP1562	BREMBO
2.2 2.2i	108	10/00 →	FCP1560	BREMBO

ZAFIRA (L75)

2.0 VXR	177	11/05 →	FCP1520	ATE
---------	-----	---------	---------	-----

ZAFIRA Mk I (A) (F75)

1.6 16V	74	04/99 →	FCP1295	ATE
1.6 16V	74	04/99 → 08/05	FCP1295	ATE
1.6 16V	74	04/99 →		FCP1294 BOSCH
1.6 16V	74	04/99 → 08/05		FCP1521 LUCAS/TRW
1.8 16V	85	04/99 →	FCP1295	ATE
1.8 16V	85	04/99 →		FCP1294 BOSCH
1.8 16V	85	05/99 → 08/00	FCP1295	ATE
1.8 16V	85	05/99 → 08/00		FCP1521 LUCAS/TRW
1.8 16V	92	09/00 → 08/05	FCP1295	ATE
1.8 16V	92	09/00 → 08/05		FCP1521 LUCAS/TRW
1.8 Dualfuel	92	09/00 → 08/05	FCP1295	ATE
1.8 Dualfuel	92	09/00 → 08/05		FCP1521 LUCAS/TRW
2.0	147	06/02 → 06/05	FCP1068	ATE
2.0	147	06/02 → 06/05		FCP1521 LUCAS/TRW
2.0 DI 16V	60	02/99 →	FCP1295	ATE
2.0 DI 16V	60	02/99 →		FCP1294 BOSCH

For material availability see page 16-18 / Per la disponibilità materiali vedere a pagina 16-18

1230

FERODO

RACING

Updated on 17th Aug 2018

VAUXHALL



KW

**...VAUXHALL****...ZAFIRA Mk I (A) (F75)**

2.0 DI 16V	60	10/99 → 08/05
2.0 DI 16V	60	10/99 → 08/05
2.0 DTi 16V	74	04/99 → 08/05
2.0 DTi 16V	74	04/99 → 08/05
2.0 DTi 16V	74	07/00 →
2.0 DTi 16V	74	07/00 →
2.0 GSI Turbo	141	09/01 → 06/05
2.0 GSI Turbo	141	09/01 → 06/05
2.2 16V	108	11/98 → 08/04
2.2 16V	108	11/98 → 08/04
2.2 D	92	06/01 → 06/05
2.2 D	92	06/01 → 06/05

ZAFIRA Mk II (B) (M75)

1.6	77	07/05 →
1.6	77	07/05 →
1.6	85	12/07 →
1.6	85	12/07 →
1.6 CNG	69	07/05 →
1.6 CNG	69	07/05 →
1.6 CNG Turbo	110	02/09 →
1.6 CNG Turbo	110	02/09 →
1.7 CDTi	81	04/09 →
1.7 CDTi	81	04/09 →
1.7 CDTi	92	01/08 →
1.7 CDTi	92	01/08 →
1.8	103	04/05 →
1.8	103	04/05 →
1.9 CDTi	110	07/05 →
1.9 CDTi	110	07/05 →
1.9 CDTi	74	07/05 →
1.9 CDTi	74	07/05 →
1.9 CDTi	88	07/05 →
1.9 CDTi	88	07/05 →
2.0	147	07/05 →
2.0	147	07/05 →
2.0	176	01/06 →
2.0	176	01/06 →
2.2	110	07/05 →
2.2	110	07/05 →

VOLKSWAGEN**1600**

1.6 TA, TE, Variant		01/72 → 12/73
---------------------	--	---------------

411

1.7		01/67 → 12/73
-----	--	---------------

Beetle

1.8 (Turbo) 20V		01/98 →
1.8 (Turbo) 20V		01/98 →
1.8 (Turbo) 20V		01/98 →
1.8 i Turbo 20V		10/99 →
1.9 TDi		01/98 →
1.9 TDi		01/98 →
2.0		01/98 →
2.0		01/98 →
2.0 i		01/98 →
2.3 V5 20V		01/98 →
2.3 V5 20V		01/98 →

BORA (1J2)

1.4 16V	55	03/00 → 05/05
1.4 16V	55	03/00 → 05/05
1.6	74	10/98 →
1.6	74	10/98 →
1.6	75	08/00 → 05/05
1.6	75	08/00 → 05/05
1.6	78	06/02 → 10/04
1.6	78	06/02 → 10/04
1.6 16V	77	05/00 → 05/05
1.6 16V	77	05/00 → 05/05
1.6 FSI	81	01/02 → 05/05
1.6 FSI	81	01/02 → 05/05

NOTE

NOTE

FCP1295

ATE

FCP1521

LUCAS/TRW

FCP1295

ATE

FCP1521

LUCAS/TRW

FCP1295

ATE

FCP1294

BOSCH

FCP1068

ATE

FCP1521

LUCAS/TRW

FCP1295

ATE

FCP1521

LUCAS/TRW

FCP1295

ATE

FCP1521

LUCAS/TRW

FCP1295

ATE

FCP1521

LUCAS/TRW

FCP1640

ATE

FCP1521

LUCAS/TRW

FCP1640

ATE

FCP1521

LUCAS/TRW

FCP1640

ATE

FCP1521

LUCAS/TRW

FCP1640

ATE

FCP1521

LUCAS/TRW

FCP1640

ATE

FCP1521

LUCAS/TRW

FCP1640

ATE

FCP1521

LUCAS/TRW

FCP1640

ATE

FCP1521

LUCAS/TRW

FCP1640

ATE

FCP1521

LUCAS/TRW

FCP1640

ATE

FCP1521

LUCAS/TRW

FCP1640

ATE

FCP1521

LUCAS/TRW

FCP1640

ATE

FCP1521

LUCAS/TRW

FCP1640

ATE

FCP1521

LUCAS/TRW

FCP1640

ATE

FCP1521

LUCAS/TRW

VOLKSWAGEN**1600**

1.6 TA, TE, Variant		01/72 → 12/73
---------------------	--	---------------

411

1.7		01/67 → 12/73
-----	--	---------------

Beetle

1.8 (Turbo) 20V		01/98 →
1.8 (Turbo) 20V		01/98 →
1.8 (Turbo) 20V		01/98 →
1.8 i Turbo 20V		10/99 →
1.9 TDi		01/98 →
1.9 TDi		01/98 →
2.0		01/98 →
2.0		01/98 →
2.0 i		01/98 →
2.3 V5 20V		01/98 →
2.3 V5 20V		01/98 →

BORA (1J2)

1.4 16V	55	03/00 → 05/05
1.4 16V	55	03/00 → 05/05
1.6	74	10/98 →
1.6	74	10/98 →
1.6	75	08/00 → 05/05
1.6	75	08/00 → 05/05
1.6	78	06/02 → 10/04
1.6	78	06/02 → 10/04
1.6 16V	77	05/00 → 05/05
1.6 16V	77	05/00 → 05/05
1.6 FSI	81	01/02 → 05/05
1.6 FSI	81	01/02 → 05/05

PR 1LQ-1LR-1LS-1ZM-1ZP

PR 1LE-1LJ-1LN-1ZD-1ZE

For material availability see page 16-18 / Per la disponibilità materiali vedere a pagina 16-18

FERODO

RACING

Updated on 17th Aug 2018

1231



KW

**...VOLKSWAGEN****...BORA (1J2)**

			NOTE			NOTE		
1.6 FSI	81	01/02 → 05/05	FCP1094	ATE	PR 1LQ-1LS-1ZM(To Ch.No. 1JX800000)	FCP1491	LUCAS/TRW	
1.8	92	10/98 → 05/05	FCP590	ATE	PR 1LJ-1LE-1ZE(da ChJY000001),1ZD(da ChJ1000001)			
1.8	92	10/98 → 05/05				FCP1491	LUCAS/TRW	
1.8 4motion	92	02/99 → 05/05	FCP1094	ATE	PR 1LQ-1LS-1ZM(To Ch.No. 1JX800000)			
1.8 4motion	92	02/99 → 05/05	FCP590	ATE	PR 1LJ-1LE-1ZE(da ChJY000001),1ZD(da ChJ1000001)			
1.8 4motion	92	02/99 → 05/05				FCP1491	LUCAS/TRW	
1.8 T	110	05/00 → 05/05	FCP590	ATE				
1.8 T	110	05/00 → 05/05				FCP1491	LUCAS/TRW	
1.8 T	132	03/02 → 05/05	FCP590	ATE				
1.8 T	132	03/02 → 05/05				FCP1491	LUCAS/TRW	
1.9 SDI	50	10/98 → 05/05	FCP1094	ATE	PR 1LQ-1LR-1LS-1ZM(To Ch.No. 1JX800000)			
1.9 SDI	50	10/98 → 05/05	FCP590	ATE	PR 1LJ-1LE-1ZE(da ChJY000001),1ZD(da ChJ1000001)			
1.9 SDI	50	10/98 → 05/05				FCP1491	LUCAS/TRW	
1.9 TDI	110	05/00 → 05/05	FCP590	ATE				
1.9 TDI	110	05/00 → 05/05				FCP1491	LUCAS/TRW	
1.9 TDI	66	10/98 → 06/01	FCP1094	ATE	PR 1LQ-1LR-1LS-1ZM(To Ch.No. 1JX800000)			
1.9 TDI	66	10/98 → 06/01	FCP590	ATE	PR 1LJ-1LE-1ZE(da ChJY000001),1ZD(da ChJ1000001)			
1.9 TDI	66	10/98 → 06/01				FCP1491	LUCAS/TRW	
1.9 TDI	74	09/00 → 05/05	FCP590	ATE	PR 1LE-1LJ-1ZE&PR 1ZD(From Ch.No. 1J1000001)			
1.9 TDI	74	09/00 → 05/05	FCP1094	ATE	PR 1LQ-1LS-1ZM-1ZP			
1.9 TDI	74	09/00 → 05/05				FCP1491	LUCAS/TRW	
1.9 TDI	81	10/98 → 06/01	FCP590	ATE	PR 1LJ-1LE-1ZE(da ChJY000001),1ZD(da ChJ1000001)			
1.9 TDI	81	10/98 → 06/01	FCP1094	ATE	PR 1LQ-1LR-1LS-1ZM(To Ch.No. 1JX800000)			
1.9 TDI	81	10/98 → 06/01				FCP1491	LUCAS/TRW	
1.9 TDI	85	12/98 → 01/02	FCP590	ATE	PR 1LJ-1LE-1ZE(da ChJY000001),1ZD(da ChJ1000001)			
1.9 TDI	85	12/98 → 01/02	FCP1094	ATE	PR 1LQ-1LR-1LS-1ZM(To Ch.No. 1JX800000)			
1.9 TDI	85	12/98 → 01/02				FCP1491	LUCAS/TRW	
1.9 TDI	96	11/00 → 05/05	FCP590	ATE				
1.9 TDI	96	11/00 → 05/05				FCP1491	LUCAS/TRW	
1.9 TDI 4motion	110	05/00 → 05/05	FCP590	ATE				
1.9 TDI 4motion	110	05/00 → 05/05				FCP1491	LUCAS/TRW	
1.9 TDI 4motion	66	02/99 → 06/01	FCP1094	ATE	PR 1LQ-1LR-1LS-1ZM(To Ch.No. 1JX800000)			
1.9 TDI 4motion	66	02/99 → 06/01	FCP590	ATE	PR 1LJ-1LE-1ZE(da ChJY000001),1ZD(da ChJ1000001)			
1.9 TDI 4motion	66	02/99 → 06/01				FCP1491	LUCAS/TRW	
1.9 TDI 4motion	74	09/00 → 05/05	FCP1094	ATE	PR 1LQ-1LS-1ZF-1ZM(From Ch.No. 1JY000001)			
1.9 TDI 4motion	74	09/00 → 05/05	FCP590	ATE	PR 1LE-1LJ-1ZE&PR 1ZD(From Ch.No. 1J1000001)			
1.9 TDI 4motion	74	09/00 → 05/05				FCP1491	LUCAS/TRW	
1.9 TDI 4motion	85	02/99 → 06/01	FCP1094	ATE	PR 1LQ-1LR-1LS-1ZM(To Ch.No. 1JX800000)			
1.9 TDI 4motion	85	02/99 → 06/01	FCP590	ATE	PR 1LJ-1LE-1ZE(da ChJY000001),1ZD(da ChJ1000001)			
1.9 TDI 4motion	85	02/99 → 06/01				FCP1491	LUCAS/TRW	
1.9 TDI 4motion	96	11/00 → 05/05	FCP590	ATE				
1.9 TDI 4motion	96	11/00 → 05/05				FCP1491	LUCAS/TRW	
2.0	85	10/98 → 05/05	FCP1094	ATE	PR 1LQ-1LR-1LS-1ZM(To Ch.No. 1JX800000)			
2.0	85	10/98 → 05/05	FCP590	ATE	PR 1LJ-1LE-1ZE(da ChJY000001),1ZD(da ChJ1000001)			
2.0	85	10/98 → 05/05				FCP1491	LUCAS/TRW	
2.0 4motion	85	04/00 → 05/05	FCP1094	ATE	PR 1LQ-1LR-1LS-1ZM(To Ch.No. 1JX800000)			
2.0 4motion	85	04/00 → 05/05	FCP590	ATE	PR 1LJ-1LE-1ZE(da ChJY000001),1ZD(da ChJ1000001)			
2.0 4motion	85	04/00 → 05/05				FCP1491	LUCAS/TRW	
2.3 V5	110	10/98 → 10/00	FCP590	ATE				
2.3 V5	110	10/98 → 10/00				FCP1491	LUCAS/TRW	
2.3 V5	125	10/00 → 05/05	FCP590	ATE				
2.3 V5	125	10/00 → 05/05				FCP1491	LUCAS/TRW	
2.3 V5 4motion	110	12/98 → 10/00	FCP590	ATE				
2.3 V5 4motion	110	12/98 → 10/00				FCP1491	LUCAS/TRW	
2.3 V5 4motion	125	10/00 → 05/05	FCP590	ATE				
2.3 V5 4motion	125	10/00 → 05/05				FCP1491	LUCAS/TRW	
2.8 V6 4Motion	150	03/99 → 05/05	FCP590	ATE				
2.8 V6 4Motion	150	03/99 → 05/05				FCP1491	LUCAS/TRW	

BORA Estate (1J6)

1.4 16V	55	09/01 → 05/05	FCP1094	ATE				
1.4 16V	55	09/01 → 05/05				FCP1491	LUCAS/TRW	
1.6	74	05/99 → 05/05	FCP1094	ATE				
1.6	74	05/99 → 05/05				FCP1491	LUCAS/TRW	
1.6	75	08/00 → 05/05	FCP1094	ATE				
1.6	75	08/00 → 05/05				FCP1491	LUCAS/TRW	
1.6 16V	77	02/00 → 05/05	FCP1094	ATE				
1.6 16V	77	02/00 → 05/05				FCP1491	LUCAS/TRW	
1.6 FSI	81	01/02 → 05/05	FCP1094	ATE	PR 1LQ-1LS-1ZF-1ZM-1ZP			
1.6 FSI	81	01/02 → 05/05	FCP590	ATE	PR 1LE-1LJ-1ZD-1ZE			
1.6 FSI	81	01/02 → 05/05				FCP1491	LUCAS/TRW	
1.8 4motion	92	05/99 → 05/05	FCP1094	ATE	PR 1LQ-1LR-1LS-1ZM(To Ch.No. 1JX800000)			
1.8 4motion	92	05/99 → 05/05	FCP590	ATE	PR 1LJ-1LE-1ZE(da ChJY000001),1ZD(da ChJ1000001)			
1.8 4motion	92	05/99 → 05/05				FCP1491	LUCAS/TRW	
1.8 T	110	05/00 → 05/05	FCP590	ATE				
1.8 T	110	05/00 → 05/05				FCP1491	LUCAS/TRW	

For material availability see page 16-18 / Per la disponibilità materiali vedere a pagina 16-18

1232

FERODO

RACING

Updated on 17th Aug 2018

VOLKSWAGEN



KW



...VOLKSWAGEN

...BORA Estate (1J6)

					NOTE			NOTE
1.8 T	132	05/02 → 05/05	FCP590	ATE				
1.8 T	132	05/02 → 05/05				FCP1491	LUCAS/TRW	
1.9 TDI	110	05/01 → 05/05	FCP590	ATE				
1.9 TDI	110	05/01 → 05/05				FCP1491	LUCAS/TRW	
1.9 TDI	66	07/04 → 05/05	FCP1094	ATE	PR 1LQ-1LR-1LS-1ZM(To Ch.No. 1JX800000)			
1.9 TDI	66	07/04 → 05/05	FCP590	ATE	PR 1LJ-1LE-1ZE(da ChJY000001),1ZD(da ChJ1000001)			
1.9 TDI	66	07/04 → 05/05				FCP1491	LUCAS/TRW	
1.9 TDI	74	09/00 → 05/05	FCP1094	ATE	PR 1LQ-1LR-1LS-1ZM(To Ch.No. 1JX800000)			
1.9 TDI	74	09/00 → 05/05	FCP590	ATE	PR 1LJ-1LE-1ZE(da ChJY000001),1ZD(da ChJ1000001)			
1.9 TDI	74	09/00 → 05/05				FCP1491	LUCAS/TRW	
1.9 TDI	81	05/99 → 06/01	FCP1094	ATE	PR 1LQ-1LR-1LS-1ZM(To Ch.No. 1JX800000)			
1.9 TDI	81	05/99 → 06/01	FCP590	ATE	PR 1LJ-1LE-1ZE(da ChJY000001),1ZD(da ChJ1000001)			
1.9 TDI	81	05/99 → 06/01				FCP1491	LUCAS/TRW	
1.9 TDI	85	05/99 → 06/01	FCP1094	ATE	PR 1LQ-1LR-1LS-1ZM(To Ch.No. 1JX800000)			
1.9 TDI	85	05/99 → 06/01	FCP590	ATE	PR 1LJ-1LE-1ZE(da ChJY000001),1ZD(da ChJ1000001)			
1.9 TDI	85	05/99 → 06/01				FCP1491	LUCAS/TRW	
1.9 TDI	96	11/00 → 05/05	FCP590	ATE				
1.9 TDI	96	11/00 → 05/05				FCP1491	LUCAS/TRW	
1.9 TDI 4motion	110	05/01 → 05/05	FCP590	ATE				
1.9 TDI 4motion	110	05/01 → 05/05				FCP1491	LUCAS/TRW	
1.9 TDI 4motion	74	09/00 → 05/05	FCP1094	ATE	PR 1LQ-1LR-1LS-1ZM(To Ch.No. 1JX800000)			
1.9 TDI 4motion	74	09/00 → 05/05	FCP590	ATE	PR 1LJ-1LE-1ZE(da ChJY000001),1ZD(da ChJ1000001)			
1.9 TDI 4motion	74	09/00 → 05/05				FCP1491	LUCAS/TRW	
1.9 TDI 4motion	85	05/99 → 06/01	FCP1094	ATE	PR 1LQ-1LR-1LS-1ZM(To Ch.No. 1JX800000)			
1.9 TDI 4motion	85	05/99 → 06/01	FCP590	ATE	PR 1LJ-1LE-1ZE(da ChJY000001),1ZD(da ChJ1000001)			
1.9 TDI 4motion	85	05/99 → 06/01				FCP1491	LUCAS/TRW	
1.9 TDI 4motion	96	11/00 → 05/05	FCP590	ATE				
1.9 TDI 4motion	96	11/00 → 05/05				FCP1491	LUCAS/TRW	
2.0	85	05/99 → 05/05	FCP1094	ATE	PR 1LQ-1LR-1LS-1ZM(To Ch.No. 1JX800000)			
2.0	85	05/99 → 05/05	FCP590	ATE	PR 1LJ-1LE-1ZE(da ChJY000001),1ZD(da ChJ1000001)			
2.0	85	05/99 → 05/05				FCP1491	LUCAS/TRW	
2.0 4motion	85	04/00 → 05/05	FCP1094	ATE	PR 1LQ-1LS-1ZF-1ZM-1ZP			
2.0 4motion	85	04/00 → 05/05	FCP590	ATE	PR 1LE-1LJ-1ZE&PR 1ZD(From Ch.No. 1J1000001)			
2.0 4motion	85	04/00 → 05/05				FCP1491	LUCAS/TRW	
2.0 4motion	88	12/99 → 05/03	FCP1094	ATE				
2.0 4motion	88	12/99 → 05/03				FCP1491	LUCAS/TRW	
2.3 V5	110	05/99 → 10/00	FCP590	ATE				
2.3 V5	110	05/99 → 10/00				FCP1491	LUCAS/TRW	
2.3 V5	125	10/00 → 05/05	FCP590	ATE				
2.3 V5	125	10/00 → 05/05				FCP1491	LUCAS/TRW	
2.3 V5 4motion	110	05/99 → 10/00	FCP590	ATE				
2.3 V5 4motion	110	05/99 → 10/00				FCP1491	LUCAS/TRW	
2.3 V5 4motion	125	10/00 → 05/05	FCP590	ATE				
2.3 V5 4motion	125	10/00 → 05/05				FCP1491	LUCAS/TRW	
2.8 V6 4motion	150	05/99 → 05/05	FCP590	ATE				
2.8 V6 4motion	150	05/99 → 05/05				FCP1491	LUCAS/TRW	
2.8 VR6	150	03/00 → 05/00	FCP590	ATE				
2.8 VR6	150	03/00 → 05/00				FCP1491	LUCAS/TRW	
Caddy								
1.4 (CH No ->TR513)	44	01/96 →	FCP775	LUCAS/TRW				
1.4 (CH No TR514->)	44	04/96 →	FCP1312	LUCAS/TRW				
1.5	51	08/82 → 07/83	FCP419	KELGATE				
1.6	55	01/84 → 12/93	FCP419	KELGATE				
1.6 (CH No ->TR513)	55	01/96 → 12/00	FCP775	LUCAS/TRW				
1.6 (CH No TR514->)	55	04/96 → 12/00	FCP1312	LUCAS/TRW				
1.7 SD (CH No ->TR513)		01/96 → 12/00	FCP775	LUCAS/TRW				
1.7 SD (CH No TR514->)		04/96 → 12/00	FCP1312	LUCAS/TRW				
1.8	70	01/84 → 12/93	FCP419	KELGATE				
1.9 SDi (CH No ->TR513)		01/96 → 12/00	FCP775	LUCAS/TRW				
1.9 SDi (CH No TR514->)		04/96 → 12/00	FCP1312	LUCAS/TRW				
Caddy (II)								
1.4 i Ch.->TR513	44	01/96 → 02/04	FCP775	LUCAS/TRW				
1.4 i Ch.TR514->	44	04/96 → 02/04	FCP1312	LUCAS/TRW				
1.6 i Ch.->TR513	55	01/96 → 02/04	FCP775	LUCAS/TRW				
1.6 i Ch.TR514->	55	04/96 → 02/04	FCP1312	LUCAS/TRW				
1.7 SD Ch.->TR513		01/96 → 02/04	FCP775	LUCAS/TRW				
1.7 SD Ch.TR514->		04/96 → 02/04	FCP1312	LUCAS/TRW				
1.9 SDi Ch.->TR513		01/96 → 02/04	FCP775	LUCAS/TRW				
1.9 SDi Ch.TR514->		04/96 → 02/04	FCP1312	LUCAS/TRW				

For material availability see page 16-18 / Per la disponibilità materiali vedere a pagina 16-18



KW

**...VOLKSWAGEN**

NOTE

NOTE

Caddy (III)

1.4 i Life, Van	55	03/04 →	FCP1094	ATE				
1.6 i Life, Van	75	03/04 →	FCP1641	ATE				
1.9 TDi Life, Van	77	03/04 →	FCP1641	ATE				
2.0 SDi Life, Van	51	03/04 →	FCP1641	ATE				
2.0 TDi 16v (2CA,2CB)	81	10/10 →	FCP1094	ATE	PR 1ZF			
2.0 TDi 16v (2CA,2CB)	81	10/10 →	FCP1641	ATE	PR 1ZE, 1ZA			
2.0 TDi 16v (2CA,2CB)	81	10/10 →				FCP4316	BOSCH	
2.0 TDi 16v (2CA,2CB)	81	10/10 →				FCP4316	BOSCH	

Caddy (IV)

2.0 TDi 16v (2CA,2CB)	103	11/10 →	FCP1094	ATE	PR 1ZF			
2.0 TDi 16v (2CA,2CB)	103	11/10 →	FCP1641	ATE	PR 1ZE,1ZA			
2.0 TDi 16v (2CA,2CB)	103	11/10 →				FCP4316	BOSCH	
2.0 TDi 16v (2CA,2CB)	103	11/10 →				FCP4316	BOSCH	

Caddy Maxi (IV)

2.0 TDi 16v (2CH,2CJ)	103	11/10 →	FCP1094	ATE	PR 1ZF			
2.0 TDi 16v (2CH,2CJ)	103	11/10 →	FCP1641	ATE	PR 1ZE, 1ZA			
2.0 TDi 16v (2CH,2CJ)	103	11/10 →				FCP4316	BOSCH	
2.0 TDi 16v (2CH,2CJ)	103	11/10 →				FCP4316	BOSCH	
2.0 TDi 16v (2CH,2CJ)	81	10/10 →	FCP1094	ATE	PR 1ZF			
2.0 TDi 16v (2CH,2CJ)	81	10/10 →	FCP1641	ATE	PR 1ZE, 1ZA			
2.0 TDi 16v (2CH,2CJ)	81	10/10 →				FCP4316	BOSCH	
2.0 TDi 16v (2CH,2CJ)	81	10/10 →				FCP4316	BOSCH	

CC (358)

3.6 FSI 4motion	220	11/11 → 12/16	FCP4425	LUCAS/TRW	Date To:2012-06,For PR code:1LA			
3.6 FSI 4motion	220	11/11 → 12/16	FCP4223	ATE				
3.6 FSI 4motion	220	11/11 → 12/16				FCP1636	LUCAS/TRW	For PR code:2EA

Corrado

1.8	118	01/88 → 06/94	FCP774	LUCAS/TRW				
1.8	118	01/88 → 06/94				FCP541	LUCAS/TRW	
1.8 G60	118	01/88 → 06/94	FCP775	LUCAS/TRW				
1.8 G60	118	01/88 → 06/94				FCP541	LUCAS/TRW	
2.0	85	01/88 → 05/95	FCP774	LUCAS/TRW				
2.0	85	01/88 → 05/95				FCP541	LUCAS/TRW	
2.8 VR6		07/92 → 06/94	FCP775	LUCAS/TRW				
2.8 VR6		07/92 → 06/94				FCP541	LUCAS/TRW	
2.9	140	01/88 → 05/95	FCP774	LUCAS/TRW				
2.9	140	01/88 → 05/95				FCP541	LUCAS/TRW	

Derby

0.9	29	01/77 → 12/85	FCP105	ATE				
0.9	29	08/78 → 09/81	FCP105	ATE				
0.9	29	10/81 → 12/85	FCP105	ATE				
1.0	29	08/78 → 12/85	FCP105	ATE				
1.0	29	10/81 → 12/85	FCP105	ATE				
1.1	37, 44	01/77 → 12/85	FCP105	ATE				
1.1	37, 44	08/78 → 09/81	FCP105	ATE				
1.1	37, 44	10/81 → 12/85	FCP105	ATE				
1.3	40	08/78 → 12/85	FCP105	ATE				
1.3	40	10/81 → 12/85	FCP105	ATE				
1.3	44	08/78 → 12/85	FCP105	ATE				
1.3	44	10/81 → 12/85	FCP105	ATE				
1.3	55	08/78 → 12/85	FCP105	ATE				
1.3	55	10/81 → 12/85	FCP105	ATE				

EOS (1F7, 1F8)

2.0 TSi 16v (1F8)	155	11/10 →	FCP1641	ATE	PR 1ZA			
2.0 TSi 16v (1F8)	155	11/10 →				FCP4316	BOSCH	
3.2 3.2 V6	184	06/06 →	FCP1765	ATE				
3.2 3.2 V6	184	06/06 →				FCP1636	LUCAS/TRW	
3.6 V6	191	05/09 → 11/10	FCP4223	ATE				
3.6 V6	191	05/09 → 11/10	FCP1765	ATE	Disc Diam mm:345,For PR code:1LK			
3.6 V6	191	05/09 → 11/10				FCP1636	LUCAS/TRW	For PR code:1KZ

Fox

1.2 i 6V	40	04/05 →	FCP1101	ATE				
1.2 i 6V	40	04/05 →	FCP1094	ATE				
1.4 i	55	04/05 →	FCP1101	ATE				
1.4 i	55	04/05 →	FCP1094	ATE				
1.4 TDi	51	04/05 →	FCP1101	ATE				
1.4 TDi	51	04/05 →	FCP1094	ATE				

For material availability see page 16-18 / Per la disponibilità materiali vedere a pagina 16-18

1234

FERODO

RACING

Updated on 17th Aug 2018

VOLKSWAGEN



KW

**...VOLKSWAGEN**

NOTE

NOTE

Golf (1)

1.1	37, 38	01/74 → 06/83	FCP105	ATE			
1.1	37, 38	08/75 → 12/78	FCP105	ATE			
1.1 i	37, 38	01/79 → 06/83	FCP105	ATE			
1.3	43, 44	01/74 → 06/83	FCP105	ATE			
1.3 i	43, 44	01/79 → 06/83	FCP105	ATE			
1.5	51	04/74 → 08/78	FCP105	ATE			
1.5	51	09/78 → 07/83	FCP419	KELGATE			
1.5 D	37	01/74 → 07/80	FCP105	ATE			
1.5 D	37	01/79 → 07/80	FCP105	ATE			
1.5 D	37	08/80 → 06/83	FCP419	KELGATE			
1.6	51, 55	01/74 → 07/80	FCP105	ATE			
1.6	51, 55	08/80 → 06/83	FCP419	KELGATE			
1.6 Cabrio	55	08/81 → 07/83	FCP419	KELGATE			
1.6 Cabrio	81	01/79 → 07/81	FCP105	ATE			
1.6 D		01/74 → 12/78	FCP105	ATE			
1.6 D	40	01/81 → 06/83	FCP105	ATE			
1.6 i GTi	81	01/75 → 10/79	FCP105	ATE			
1.6 i GTi	81	01/75 → 07/83	FCP392	KELGATE			
1.6 TD	51	07/82 → 07/83	FCP419	KELGATE			
1.8 GTi	82	01/75 → 12/83	FCP392	KELGATE			

Golf (2)

1.0	33	11/83 → 08/91	FCP385	KELGATE	Manual		
1.0	37	11/83 → 08/91	FCP419	KELGATE	Automatic		
1.0	37	01/89 → 08/91	FCP419	KELGATE			
1.1	33	07/83 → 08/91	FCP385	KELGATE	Manual		
1.1	37	07/83 → 08/91	FCP419	KELGATE	Automatic		
1.3	33	07/83 → 08/91	FCP385	KELGATE	Manual		
1.3	37	07/83 → 08/91	FCP419	KELGATE	Automatic		
1.3 Van		01/84 → 05/92	FCP385	KELGATE			
1.6	51	07/83 → 08/91	FCP419	KELGATE			
1.6	53	07/83 → 08/91	FCP419	KELGATE			
1.6	55	07/83 → 08/91	FCP419	KELGATE			
1.6 Cabrio	53, 55	01/84 → 12/91	FCP392	KELGATE			
1.6 D		08/83 → 08/91	FCP385	KELGATE			
1.6 D Van		01/84 → 05/92	FCP419	KELGATE			
1.6 TD	51, 55	08/83 → 08/91	FCP385	KELGATE			
1.6 TD Van		01/84 → 05/92	FCP419	KELGATE			
1.8	66	08/84 → 10/91	FCP419	KELGATE			
1.8 C, CL, GL, GLX, Carat	62, 66	08/83 → 12/91	FCP419	KELGATE			
1.8 Cabrio	55, 66	01/84 → 08/93	FCP392	KELGATE			
1.8 Cl, CLI, GLI	62, 66	01/84 → 12/91	FCP419	KELGATE			
1.8 GT, Gti	62, 66	08/86 → 12/91	FCP392	KELGATE			
1.8 GT, Gti	62, 66	08/86 → 12/91			FCP596	LUCAS/TRW	
1.8 GTi 16V	102	10/85 → 07/86	FCP392	KELGATE			
1.8 GTi 16V	102	10/85 → 07/86			FCP596	LUCAS/TRW	
1.8 i Cat	66	08/87 → 10/91	FCP419	KELGATE			
1.8 i Cat Syncro	66	08/87 → 10/91	FCP419	KELGATE			
1.8 i GTi G60 16V	118	08/83 → 08/88	FCP392	KELGATE			
1.8 i GTi G60 16V	118	08/83 → 08/88			FCP541	LUCAS/TRW	
1.8 i GTi G60 16V	118	09/88 → 08/91	FCP775	LUCAS/TRW			
1.8 i GTi G60 16V	118	09/88 → 08/91	FCP774	LUCAS/TRW			
1.8 i GTi G60 16V	118	09/88 → 08/91			FCP541	LUCAS/TRW	
1.8 Syncro	66	02/86 → 07/91	FCP419	KELGATE			
1.8 Syncro	72	08/88 → 07/91	FCP419	KELGATE			
1.9 TD Van		05/92 →	FCP774	LUCAS/TRW			

Golf (3)

1.4 i Variant	40, 44	01/93 → 09/97	FCP419	KELGATE			
1.4 Saloon, Variant	40, 44	08/91 → 08/95	FCP1288	LUCAS/TRW			
1.4 Saloon, Variant	40, 44	08/91 → 08/95			FCP541	LUCAS/TRW	
1.4 Saloon, Variant	40, 44	09/95 → 04/97	FCP1054	ATE			
1.4 Variant	40, 44	01/95 → 09/97	FCP1288	KELGATE			
1.6	54, 74	09/95 → 04/97	FCP1054	ATE			
1.6	55	08/91 → 08/95	FCP419	KELGATE			
1.6	55	08/91 → 08/95	FCP774	LUCAS/TRW			
1.6	55	08/91 → 08/95			FCP541	LUCAS/TRW	
1.6 i Cabrio	74	10/94 → 05/98	FCP775	LUCAS/TRW			
1.6 i Cabrio	74	06/98 →	FCP1312	LUCAS/TRW			
1.6 Saloon, Variant	55, 74	09/95 → 04/97	FCP775	LUCAS/TRW			
1.6 Saloon, Variant	55, 74	09/95 → 04/97	FCP1288	LUCAS/TRW			
1.8	55, 66	08/91 → 08/95	FCP419	KELGATE			
1.8	55, 66	08/91 → 08/95	FCP1288	LUCAS/TRW			
1.8	55, 66	08/91 → 08/95			FCP541	LUCAS/TRW	
1.8	66, 72	09/95 → 09/97	FCP419	ATE	ABS		
1.8	66, 72	09/95 → 09/97	FCP1054	ATE			
1.8 GT	66	08/91 → 04/97	FCP774	LUCAS/TRW			

For material availability see page 16-18 / Per la disponibilità materiali vedere a pagina 16-18



KW



...VOLKSWAGEN

...Golf (3)

					NOTE			NOTE
1.8 GT	66	08/91 → 04/97				FCP541	LUCAS/TRW	
1.8 i Cabrio	55	06/98 →	FCP775	LUCAS/TRW				
1.8 i Cabrio	55, 66	07/93 → 05/98	FCP775	LUCAS/TRW				
1.8 i Cabrio	66	06/98 →	FCP774	LUCAS/TRW				
1.8 Saloon, Variant		09/95 → 04/97	FCP775	LUCAS/TRW				
1.8 Saloon, Variant		09/95 → 04/97	FCP1288	LUCAS/TRW				
1.8 Variant	55, 66	01/93 → 09/97	FCP419	KELGATE				
1.9 D	48, 55	08/91 → 06/95	FCP419	KELGATE				
1.9 D	48, 55	08/91 → 06/95	FCP774	LUCAS/TRW				
1.9 D	48, 55	08/91 → 06/95				FCP541	LUCAS/TRW	
1.9 D	47	07/95 → 09/97	FCP1054	ATE				
1.9 D	48	07/95 → 09/97	FCP1054	ATE				
1.9 D	55	07/95 → 09/97	FCP1054	ATE				
1.9 D GT	47	08/91 → 07/95	FCP774	LUCAS/TRW				
1.9 D GT	47	08/91 → 07/95				FCP541	LUCAS/TRW	
1.9 D GT	48	08/91 → 07/95	FCP774	LUCAS/TRW				
1.9 D GT	48	08/91 → 07/95				FCP541	LUCAS/TRW	
1.9 D GT	55	08/91 → 07/95	FCP774	LUCAS/TRW				
1.9 D GT	55	08/91 → 07/95				FCP541	LUCAS/TRW	
1.9 D Variant		01/93 → 08/95	FCP775	LUCAS/TRW				
1.9 D Variant		09/95 → 09/97	FCP774	LUCAS/TRW				
1.9 TD	66	08/91 → 06/95	FCP419	KELGATE				
1.9 TD	66	08/91 → 06/95	FCP774	LUCAS/TRW				
1.9 TD	66	08/91 → 06/95				FCP541	LUCAS/TRW	
1.9 TD	66	07/95 → 09/97	FCP1054	ATE				
1.9 TD GT	66	08/91 → 07/95	FCP774	LUCAS/TRW				
1.9 TD GT	66	08/91 → 07/95				FCP541	LUCAS/TRW	
1.9 TD Variant (1H5)	55	07/93 → 04/99	FCP775	LUCAS/TRW	No Abs			
1.9 TD Variant (1H5)	55	05/96 → 10/96	FCP774	LUCAS/TRW	with ABS			
1.9 TD Variant (1H5)	55	10/96 → 04/99	FCP1288	ATE	with ABS			
1.9 TDi		09/93 → 08/97	FCP774	LUCAS/TRW				
1.9 TDi		09/93 → 08/97	FCP1312	LUCAS/TRW				
1.9 TDi		09/93 → 08/97				FCP541	LUCAS/TRW	
1.9 TDi		04/96 → 08/97	FCP774	LUCAS/TRW				
1.9 TDi Cabrio	66	08/95 → 05/98	FCP775	LUCAS/TRW				
1.9 TDi Cabrio	66	08/95 → 05/98	FCP1312	LUCAS/TRW				
1.9 TDi Cabrio	66	08/95 → 05/98				FCP541	LUCAS/TRW	
1.9 TDi Cabrio	66	06/98 →	FCP775	LUCAS/TRW				
1.9 TDi Cabrio	81	07/96 → 05/98	FCP1312	LUCAS/TRW				
1.9 TDi Cabrio	81	06/98 →	FCP1312	LUCAS/TRW				
1.9 TDi Cabrio	81	06/98 →				FCP541	LUCAS/TRW	
1.9 TDi Syncro		01/95 → 12/97	FCP590	ATE				
2.0 Cabrio, Variant	85	01/93 → 09/97	FCP774	LUCAS/TRW				
2.0 Cabrio, Variant	85	01/93 → 09/97				FCP541	LUCAS/TRW	
2.0 GTi 16V	110	08/91 → 06/95	FCP775	LUCAS/TRW				
2.0 GTi 16V	110	08/91 → 06/95				FCP541	LUCAS/TRW	
2.0 i GTi 16V		07/95 → 09/97	FCP775	LUCAS/TRW				
2.0 i GTi 16V		07/95 → 09/97				FCP541	LUCAS/TRW	
2.0 i Syncro		01/95 → 12/97	FCP590	ATE				
2.8 VR6	128	08/91 → 09/97	FCP775	LUCAS/TRW				
2.8 VR6	128	08/91 → 09/97				FCP541	LUCAS/TRW	
2.9 i VR6 Syncro	140	11/94 → 12/97	FCP590	ATE				

Golf (4)

1.4 16V		10/97 → 12/00	FCP1094	ATE				
1.4 16V		10/97 → 12/00				FCP541	LUCAS/TRW	
1.4 16V	55	01/00 → 09/03	FCP1094	ATE				
1.4 16V	55	01/00 → 09/03				FCP541	LUCAS/TRW	
1.4 Saloon, Variant		04/97 → 03/98	FCP1054	ATE				
1.4 Saloon, Variant		04/97 → 03/98	FCP392	ATE				
1.4 Variant		09/97 → 03/98	FCP1288	KELGATE				
1.6	74	04/97 → 03/98	FCP1054	ATE				
1.6	74	04/97 → 03/98	FCP392	ATE				
1.6	74	04/98 → 12/00	FCP1094	ATE				
1.6	74	04/98 → 12/00				FCP541	LUCAS/TRW	
1.6	75	01/00 → 09/03	FCP1094	ATE				
1.6	75	01/00 → 09/03				FCP541	LUCAS/TRW	
1.6 16V	74	12/97 → 04/98	FCP1094	ATE				
1.6 16V	74	12/97 → 04/98				FCP541	LUCAS/TRW	
1.6 Saloon, Variant	74	04/97 → 03/98	FCP775	LUCAS/TRW				
1.6 Saloon, Variant	74	04/97 → 03/98	FCP1288	LUCAS/TRW				
1.8	66, 72	09/97 → 03/98	FCP392	ATE				
1.8	66, 72	09/97 → 03/98	FCP1054	ATE				
1.8	92	04/98 → 12/00	FCP1094	ATE				
1.8	92	04/98 → 12/00				FCP541	LUCAS/TRW	
1.8	92	01/00 → 09/03	FCP1094	ATE				
1.8	92	01/00 → 09/03				FCP541	LUCAS/TRW	

For material availability see page 16-18 / Per la disponibilità materiali vedere a pagina 16-18

1236

FERODO

RACING

Updated on 17th Aug 2018

VOLKSWAGEN



KW



...VOLKSWAGEN

...Golf (4)

				NOTE			NOTE
1.8 (Turbo)	04/98 → 12/00	FCP590	ATE				
1.8 (Turbo)	04/98 → 12/00				FCP541	LUCAS/TRW	
1.8 Saloon, Variant	04/97 → 03/98	FCP775	LUCAS/TRW				
1.8 Saloon, Variant	04/97 → 03/98	FCP1288	LUCAS/TRW				
1.8 T GTI (1J1)	132 01/00 → 09/03	FCP590	ATE				
1.8 T GTI (1J1)	132 01/00 → 09/03				FCP541	LUCAS/TRW	
1.8 Variant	55, 66 09/97 → 02/99	FCP419	KELGATE				
1.9 D	09/97 → 03/98	FCP1054	ATE				
1.9 D Variant	09/97 → 04/99	FCP774	LUCAS/TRW				
1.9 SDi	50 04/98 → 12/00	FCP1094	ATE				
1.9 SDi	50 04/98 → 12/00				FCP541	LUCAS/TRW	
1.9 SDi	50 01/00 → 09/03	FCP1094	ATE				
1.9 SDi	50 01/00 → 09/03				FCP541	LUCAS/TRW	
1.9 TDi	110 05/00 → 06/05	FCP590	ATE	288mm discs			
1.9 TDi	110 05/00 → 06/05				FCP541	LUCAS/TRW	
1.9 TDi	66 10/97 → 05/04	FCP1094	ATE	280mm discs			
1.9 TDi	66 10/97 → 05/04				FCP541	LUCAS/TRW	
1.9 TDi	74 09/00 → 06/05	FCP1094	ATE	280mm discs			
1.9 TDi	74 09/00 → 06/05				FCP541	LUCAS/TRW	
1.9 TDi	81 08/97 → 05/04	FCP1094	ATE	280mm discs			
1.9 TDi	81 08/97 → 05/04				FCP541	LUCAS/TRW	
1.9 TDi	85 12/98 → 06/01	FCP1094	ATE	280mm discs			
1.9 TDi	85 12/98 → 06/01				FCP541	LUCAS/TRW	
1.9 TDi	96 11/00 → 06/05	FCP590	ATE	288mm discs			
1.9 TDi	96 11/00 → 06/05				FCP541	LUCAS/TRW	
2.0 Cabrio, Variant	85 09/97 → 04/98	FCP774	LUCAS/TRW				
2.0 Cabrio, Variant	85 09/97 → 04/98				FCP541	LUCAS/TRW	
2.0 i 16V	05/98 → 12/00	FCP1094	ATE				
2.0 i 16V	05/98 → 12/00				FCP541	LUCAS/TRW	
2.0 i 16V	85 01/00 → 09/03	FCP1094	ATE				
2.0 i 16V	85 01/00 → 09/03				FCP541	LUCAS/TRW	
2.3 i VR5	110 12/97 → 12/00	FCP590	ATE				
2.3 i VR5	110 12/97 → 12/00				FCP541	LUCAS/TRW	
2.3 i VR5	125 01/00 → 09/03	FCP590	ATE				
2.3 i VR5	125 01/00 → 09/03				FCP541	LUCAS/TRW	
3.2 R32 4motion (1J1)	177 09/02 → 06/05	FCP1765	ATE	PR 1LJ (1 piston caliper)			
3.2 R32 4motion (1J1)	177 09/02 → 06/05	FCP1001	ATE	PR 1ZT (2 piston caliper)			
3.2 R32 4motion (1J1)	177 09/02 → 06/05				FCP1491	LUCAS/TRW	

Golf (5)

1.4 i 16V	55 10/03 → 12/03	FCP1094	ATE				
1.4 i 16V	59 12/03 →	FCP1094	ATE				
1.4 i 16V	59 12/03 →				FCP1636	LUCAS/TRW	
1.6 FSi	85 10/03 → 12/03	FCP1094	ATE				
1.6 FSi	85 12/03 →	FCP1094	ATE				
1.6 FSi	85 12/03 →				FCP1636	LUCAS/TRW	
1.9 TDi	66 10/03 → 12/03	FCP1094	ATE				
1.9 TDi	77 12/03 →	FCP1094	ATE				
1.9 TDi	77 12/03 →				FCP1636	LUCAS/TRW	
2.0 FSi	110 01/04 →	FCP1641	ATE				
2.0 FSi	110 01/04 →				FCP1636	LUCAS/TRW	
2.0 GTI	147 10/04 →	FCP1641	ATE				
2.0 GTI	147 10/04 →				FCP1636	LUCAS/TRW	
2.0 GTI(1K1)	169 09/06 →	FCP1765	ATE				
2.0 GTI(1K1)	169 09/06 →				FCP1636	LUCAS/TRW	
2.0 TDi	100 10/03 →	FCP1641	ATE				
2.0 TDi	100 10/03 →				FCP1636	LUCAS/TRW	

Golf (5) Plus

1.4 i 16V	55 01/05 →	FCP1094	ATE				
1.4 i 16V	55 01/05 →				FCP1636	LUCAS/TRW	
1.6 Fsi 16V	85 01/05 →	FCP1094	ATE				
1.6 Fsi 16V	85 01/05 →				FCP1636	LUCAS/TRW	
1.9 TDi	77 01/05 →	FCP1094	ATE				
1.9 TDi	77 01/05 →				FCP1636	LUCAS/TRW	
2.0 TDi 16V	103 01/05 →	FCP1641	ATE				
2.0 TDi 16V	103 01/05 →				FCP1636	LUCAS/TRW	

GOLF ALLTRACK (BA5)

1.6 TDI 4motion	81 12/14 →	FCP4433	TRW	Disc Diam mm:288, For PR code:1ZE			
1.6 TDI 4motion	81 12/14 →				FCP4434	ATE	For PR code:1KE
1.8 TSI 4motion	132 12/14 →	FCP4433	TRW	Disc Diam mm:288, For PR code:1ZE			
1.8 TSI 4motion	132 12/14 →				FCP4434	ATE	Disc Diam mm:272, For PR code:1KE
2.0 TDI 4motion	110 12/14 →	FCP4433	TRW	Disc Diam mm:288, For PR code:1ZE			
2.0 TDI 4motion	110 12/14 →				FCP4434	ATE	Disc Diam mm:272, For PR code:1KE
2.0 TDI 4motion	135 12/14 →	FCP4433	TRW	Disc Diam mm:312, For PR code:1LV			
2.0 TDI 4motion	135 12/14 →				FCP4434	ATE	Disc Diam mm:272, For PR code:1KE

For material availability see page 16-18 / Per la disponibilità materiali vedere a pagina 16-18



KW

**...VOLKSWAGEN****GOLF SPORTSVAN**

1.2 TSI	63	05/14	→	FCP4433	TRW	Disc Diam mm:288,For PR code:1ZE
1.2 TSI	63	05/14	→			

GOLF SPORTSVAN (AM1)

1.0 TSI	85	05/15	→	FCP4433	TRW	Disc Diam mm:288,For PR code:1ZE
1.0 TSI	85	05/15	→			
1.2 TSI	81	04/14	→	FCP4433	TRW	Disc Diam mm:288,For PR code:1ZE
1.2 TSI	81	04/14	→			
1.4 TSI	110	02/14	→	FCP4433	TRW	Disc Diam mm:288,For PR code:1ZE
1.4 TSI	110	02/14	→			
1.4 TSI	92	04/14	→	FCP4433	TRW	Disc Diam mm:288,For PR code:1ZE
1.4 TSI	92	04/14	→			
1.4 TSI MultiFuel	92	04/14	→	FCP4433	TRW	Disc Diam mm:288,For PR code:1ZE
1.4 TSI MultiFuel	92	04/14	→			
1.6	81	05/14	→	FCP4433	TRW	Disc Diam mm:288,For PR code:1ZE
1.6	81	05/14	→			
1.6 TDI	66	02/14	→	FCP4433	TRW	Disc Diam mm:288,For PR code:1ZE
1.6 TDI	66	02/14	→			
1.6 TDI	81	02/14	→	FCP4433	TRW	Disc Diam mm:288,For PR code:1ZE
1.6 TDI	81	02/14	→			
1.6 TDI	81	02/14	→	FCP4433	TRW	Disc Diam mm:288,For PR code:1ZE
1.6 TDI	85	11/16	→			
1.6 TDI	85	11/16	→	FCP4433	TRW	Disc Diam mm:288,For PR code:1ZE
1.6 TDI	85	11/16	→			
2.0 TDI	110	02/14	→	FCP4433	TRW	Disc Diam mm:288,For PR code:1ZE
2.0 TDI	110	02/14	→			
2.0 TDI	81	05/14	→	FCP4433	TRW	Disc Diam mm:288,For PR code:1ZE
2.0 TDI	81	05/14	→			

GOLF V (1K1)

3.2	184	09/05	→ 11/08	FCP4223	ATE	
3.2	184	09/05	→ 11/08	FCP1765	ATE	Disc Diam mm:345,For PR code:1LM/1LK
3.2	184	09/05	→ 11/08			
3.2 R32 4motion	177	01/04	→ 11/08	FCP4223	ATE	
3.2 R32 4motion	177	01/04	→ 11/08	FCP1765	ATE	
3.2 R32 4motion	177	01/04	→ 11/08			
3.2 R32 4motion	184	11/05	→ 11/08	FCP1765	ATE	Disc Diam mm:345,For PR code:1LM/1LK
3.2 R32 4motion	184	11/05	→ 11/08	FCP4223	ATE	
3.2 R32 4motion	184	11/05	→ 11/08			

Golf VI (5K1)

1.4	59	10/08	→ 11/12	FCP1094	ATE	PR 1ZF
1.4	59	10/08	→ 11/12	FCP1641	ATE	PR 1ZD, 1ZE, 1ZP
1.4	59	10/08	→ 11/12			
1.4 TSI	118	10/08	→ 11/12	FCP1641	ATE	Disc Diam mm:288/312,For PR :1ZE,1LJ,1ZA,1LL,1ZB
1.4 TSI	118	10/08	→ 11/12	FCP4223	ATE	Disc Diam mm:345,For PR code:1ZK
1.4 TSI	118	10/08	→ 11/12			
1.4 TSI	118	10/08	→ 11/12	FCP1636	LUCAS/TRW	PR 1KF, 1KY, 1KZ
1.4 TSI	118	10/08	→ 11/12	FCP1491	LUCAS/TRW	
1.4 TSI	90	10/08	→ 11/12	FCP1094	ATE	PR 1ZF
1.4 TSI	90	10/08	→ 11/12	FCP1641	ATE	PR 1ZD, 1ZE, 1ZP
1.4 TSI	90	10/08	→ 11/12			
1.4 TSI	90	10/08	→ 11/12	FCP1636	LUCAS/TRW	PR 1KF, 1KY, 1KZ
1.6	75	10/08	→ 11/12	FCP1094	ATE	PR 1ZF
1.6	75	10/08	→ 11/12	FCP1641	ATE	PR 1ZD, 1ZE, 1ZP
1.6	75	10/08	→ 11/12			
1.6	75	10/08	→ 11/12	FCP1636	LUCAS/TRW	PR 1KF, 1KY, 1KZ
2.0 4motion	191	09/11	→ 11/13	FCP4223	ATE	
2.0 4motion	191	09/11	→ 11/13			
2.0 GTi	147	06/09	→ 11/13	FCP4223	ATE	Disc Diam mm:345,For PR code:1ZK
2.0 GTi	147	06/09	→ 11/13	FCP1641	ATE	Disc Diam mm:288/312,For PR :1ZE,1LJ,1ZA,1LL,1ZB
2.0 GTi	147	06/09	→ 11/13			
2.0 GTi	147	06/09	→ 11/13	FCP1636	LUCAS/TRW	Disc Diam mm:256,For PR code:1KF
2.0 GTi	147	06/09	→ 11/13	FCP4316	BOSCH	Disc Diam mm:272,For PR code:1KS/1KT
2.0 GTi	155	04/09	→ 11/12	FCP1641	ATE	PR:1LJ,1LL,1LV,1ZA,1ZB,1ZD,1ZE,1ZP
2.0 GTi	155	04/09	→ 11/12			
2.0 GTi	155	04/09	→ 11/12	FCP1636	LUCAS/TRW	PR:1KF,1KV,1KY,1KZ
2.0 GTi	155	04/09	→ 11/12	FCP4316	BOSCH	PR 1KT
2.0 R 4motion	188	11/09	→ 11/13	FCP4223	ATE	Disc Diam mm:345,For PR code:1ZK
2.0 R 4motion	188	11/09	→ 11/13			
2.0 R 4motion	195	11/09	→ 05/11	FCP4223	ATE	Disc Diam mm:345,For PR code:1ZK
2.0 R 4motion	195	11/09	→ 05/11			
2.0 R 4motion	195	11/09	→ 05/11	FCP1636	LUCAS/TRW	Disc Diam mm:256,For PR code:1KF
2.0 R 4motion	199	11/09	→ 11/12	FCP4223	ATE	Disc Diam mm:345,For PR code:1ZK
2.0 R 4motion	199	11/09	→ 11/12			
2.0 R 4motion	199	11/09	→ 11/12	FCP1636	LUCAS/TRW	Disc Diam mm:310,For PR code:1KW
2.0 TDI	100	10/08	→ 11/12	FCP4223	ATE	Disc Diam mm:345,For PR code:1ZK
2.0 TDI	100	10/08	→ 11/12	FCP1641	ATE	Disc Diam mm:288/312,For PR :1ZE,1LJ,1ZA,1LL,1ZB
2.0 TDI	100	10/08	→ 11/12			
2.0 TDI	100	10/08	→ 11/12	FCP1491	LUCAS/TRW	
2.0 TDI	103	10/08	→ 05/13	FCP1641	ATE	
2.0 TDI	103	10/08	→ 05/13			
2.0 TDI	81	10/08	→ 11/12	FCP1094	ATE	PR 1ZF
2.0 TDI	81	10/08	→ 11/12	FCP1641	ATE	PR 1ZD, 1ZE, 1ZP
2.0 TDI	81	10/08	→ 11/12			
2.0 TDI	81	10/08	→ 11/12	FCP1636	LUCAS/TRW	PR 1KF, 1KY, 1KZ
2.0 TDI	81	10/08	→ 11/12	FCP1491	LUCAS/TRW	PR 1KD
2.0 TDI 16v	125	05/09	→	FCP1641	ATE	PR 1LJ/1ZA

For material availability see page 16-18 / Per la disponibilità materiali vedere a pagina 16-18

1238

FERODO

RACING

Updated on 17th Aug 2018

VOLKSWAGEN



KW

**...VOLKSWAGEN****...Golf VI (5K1)**

						NOTE				NOTE	
2.0 TDi 16v	125	05/09 →				FCP4316	BOSCH				
2.5	112	09/09 → 11/13	FCP4223	ATE							
2.5	112	09/09 → 11/13	FCP1094	ATE							
2.5	112	09/09 → 11/13	FCP1641	ATE							
2.5	112	09/09 → 11/13				FCP1636	LUCAS/TRW				
2.5	125	07/09 → 05/13	FCP4223	ATE	Disc Diam mm:345,For PR code:1ZK						
2.5	125	07/09 → 05/13	FCP1641	ATE	Disc Diam mm:288/312,For PR :1ZE,1LJ,1ZA,1LL,1ZB						
2.5	125	07/09 → 05/13	FCP1094	ATE							
2.5	125	07/09 → 05/13				FCP1636	LUCAS/TRW			Disc Diam mm:256,For PR code:1KF	

Golf VI Cabriolet (517)

2.0 TSI	162	11/13 →	FCP4433	LUCAS/TRW							
---------	-----	---------	---------	-----------	--	--	--	--	--	--	--

GOLF VI Convertible (517)

1.2 TSI	77	03/11 → 11/13	FCP1641	ATE	Disc Diam mm:288/312,For PR code:1ZA,1ZB,1ZE						
1.2 TSI	77	03/11 → 11/13	FCP4223	ATE	Disc Diam mm:345,For PR code:1ZK						
1.2 TSI	77	03/11 → 11/13				FCP4316	BOSCH				
1.2 TSI	77	03/11 → 11/13				FCP1491	LUCAS/TRW				
1.2 TSI	77	11/13 → 11/13	FCP4433	LUCAS/TRW							
1.2 TSI 16V	77	11/13 →	FCP4223	ATE	Disc Diam mm:345,For PR code:1ZK						
1.2 TSI 16V	77	11/13 →	FCP1641	ATE	Disc Diam mm:288/312,For PR code:1ZA,1ZB,1ZE						
1.2 TSI 16V	77	11/13 →				FCP1491	LUCAS/TRW				
1.4 TSI	118	03/11 →	FCP1641	ATE	Disc Diam mm:288/312,For PR code:1ZA,1ZB,1ZE						
1.4 TSI	118	03/11 →	FCP4223	ATE	Disc Diam mm:345,For PR code:1ZK						
1.4 TSI	118	03/11 →				FCP4316	BOSCH				
1.4 TSI	118	03/11 →				FCP1491	LUCAS/TRW				
1.4 TSI	90	11/11 →	FCP1641	ATE	Disc Diam mm:288/312,For PR code:1ZA,1ZB,1ZE						
1.4 TSI	90	11/11 →	FCP4223	ATE	Disc Diam mm:345,For PR code:1ZK						
1.4 TSI	90	11/11 →				FCP4316	BOSCH				
1.4 TSI	90	11/11 →				FCP1491	LUCAS/TRW				
1.4 TSI	110	11/13 →	FCP4223	ATE	Disc Diam mm:345,For PR code:1ZK						
1.4 TSI	110	11/13 →	FCP1641	ATE	Disc Diam mm:288/312,For PR code:1ZA,1ZB,1ZE						
1.4 TSI	110	11/13 →				FCP1491	LUCAS/TRW				
1.4 TSI	92	11/13 →	FCP4223	ATE	Disc Diam mm:345,For PR code:1ZK						
1.4 TSI	92	11/13 →	FCP1641	ATE	Disc Diam mm:288/312,For PR code:1ZA,1ZB,1ZE						
1.4 TSI	92	11/13 →				FCP1491	LUCAS/TRW				
1.6 TDi	77	03/11 →	FCP1641	ATE	Disc Diam mm:288/312,For PR code:1ZA,1ZB,1ZE						
1.6 TDi	77	03/11 →	FCP4223	ATE	Disc Diam mm:345,For PR code:1ZK						
1.6 TDi	77	03/11 →				FCP4316	BOSCH				
1.6 TDi	77	03/11 →				FCP1491	LUCAS/TRW				
2.0 GTI	155	11/11 →	FCP1641	ATE	Disc Diam mm:288/312,For PR code:1ZA,1ZB,1ZE						
2.0 GTI	155	11/11 →	FCP4223	ATE	Disc Diam mm:345,For PR code:1ZK						
2.0 GTI	155	11/11 →				FCP4316	BOSCH			Disc Diam mm:272,For PR code:1KS/1KT	
2.0 R	195	01/13 →	FCP4223	ATE	Disc Diam mm:345,For PR code:1ZK						
2.0 R	195	01/13 →				FCP1636	LUCAS/TRW			Disc Diam mm:310,For PR code:1KW	
2.0 TDi	103	11/11 →	FCP1641	ATE	Disc Diam mm:288/312,For PR code:1ZA,1ZB,1ZE						
2.0 TDi	103	11/11 →	FCP4223	ATE	Disc Diam mm:345,For PR code:1ZK						
2.0 TDi	103	11/11 →				FCP4316	BOSCH				
2.0 TDi	103	11/11 →				FCP1491	LUCAS/TRW				
2.0 TDi	103	11/13 →	FCP4433	LUCAS/TRW							
2.0 TDi	110	11/13 →	FCP4223	ATE	Disc Diam mm:345,For PR code:1ZK						
2.0 TDi	110	11/13 →	FCP1641	ATE	Disc Diam mm:288/312,For PR code:1ZA,1ZB,1ZE						
2.0 TDi	110	11/13 →				FCP1491	LUCAS/TRW				
2.0 TDi	81	11/13 →	FCP4223	ATE	Disc Diam mm:345,For PR code:1ZK						
2.0 TDi	81	11/13 →	FCP1641	ATE	Disc Diam mm:288/312,For PR code:1ZA,1ZB,1ZE						
2.0 TDi	81	11/13 →				FCP1491	LUCAS/TRW				
2.0 TSi	162	11/13 →	FCP4223	ATE	Disc Diam mm:345,For PR code:1ZK						
2.0 TSi	162	11/13 →	FCP1641	ATE	Disc Diam mm:288/312,For PR code:1ZA,1ZB,1ZE						
2.0 TSi	162	11/13 →				FCP4316	BOSCH			Disc Diam mm:272,For PR code:1KS/1KT	

Golf VI Variant (AJ5)

2.0 TDi 16v	81	01/10 →	FCP1094	ATE	PR 1ZM						
2.0 TDi 16v	81	01/10 →	FCP1641	ATE	PR 1ZE						
2.0 TDi 16v	81	01/10 →				FCP4316	BOSCH				

Golf VII (5G1)

2.0 GTI	162	04/13 →	FCP4425	LUCAS/TRW	PR 1LJ - Sports package option						
2.0 GTI	162	04/13 →	FCP4433	LUCAS/TRW							
2.0 GTI	162	04/13 →				FCP4697	ATE			Disc Diam mm:310/300,For PR code:1KJ/1KY/1KV	
2.0 GTI	169	04/13 →	FCP4425	LUCAS/TRW	PR 1LJ - Sports package option						
2.0 GTI	169	04/13 →	FCP4433	LUCAS/TRW							
2.0 GTI	169	04/13 →				FCP4697	ATE			Disc Diam mm:310/300,For PR code:1KJ/1KY/1KV	
2.0 R 4motion	206	11/13 →	FCP4425	LUCAS/TRW	PR 1LJ						
2.0 R 4motion	206	11/13 →				FCP4697	ATE			Disc Diam mm:310,For PR code:1KY	
2.0 R 4motion	213	11/13 →	FCP4425	LUCAS/TRW	PR 1LJ						
2.0 R 4motion	213	11/13 →				FCP4697	ATE				
2.0 R 4motion	221	11/13 →	FCP4425	LUCAS/TRW	PR 1LJ						

For material availability see page 16-18 / Per la disponibilità materiali vedere a pagina 16-18



KW



...VOLKSWAGEN

NOTE

NOTE

...Golf VII (5G1)

2.0 R 4motion	221	11/13	→				FCP4697	ATE	Disc Diam mm:310,For PR code:1KY
GOLF VII (5G1, BE1)									
2.0 GTI	155	11/13	→	FCP4433	LUCAS/TRW	Pr Number 1ZB			
2.0 GTI	155	11/13	→				FCP4697	ATE	Disc Diam mm:310/300,For PR code:1KJ/1KY/1KV
2.0 GTI Clubsport	195	02/16	→	FCP4425	LUCAS/TRW	Pr Number 1LJ,1LM			
2.0 GTI Clubsport	195	02/16	→				FCP4697	ATE	Disc Diam mm:310, For PR code:1KJ/1KY
GOLF VII (5G1, BQ1, BE1, BE2)									
1.0 TSI	63	01/17	→	FCP4433	TRW	Disc Diam mm:288,For PR code:1ZE			
1.0 TSI	63	01/17	→				FCP4434	ATE	For PR code:1KE
1.0 TSI	81	11/16	→	FCP4433	TRW	Disc Diam mm:288,For PR code:1ZE			
1.0 TSI	81	11/16	→				FCP4434	ATE	For PR code:1KE
1.0 TSI	85	05/15	→				FCP4434	ATE	For PR code:1KE
1.2 TSI	63	08/12	→	FCP4433	LUCAS/TRW				
1.2 TSI	63	08/12	→				FCP4434	ATE	For PR code:1KE
1.2 TSI	77	11/12	→	FCP4433	LUCAS/TRW				
1.2 TSI	77	11/12	→				FCP4434	ATE	For PR code:1KE
1.2 TSI	81	04/14	→				FCP4434	ATE	For PR code:1KE
1.4 GTE Hybrid	110	05/14	→	FCP4433	TRW	For PR code:1ZD/1ZG			
1.4 GTE Hybrid	110	05/14	→				FCP4434	ATE	Disc Diam mm:272,For PR code:1KE/1KK
1.4 TGI CNG	81	06/13	→	FCP4425	LUCAS/TRW	PR 1LJ - Sport package option			
1.4 TGI CNG	81	06/13	→	FCP4433	LUCAS/TRW				
1.4 TGI CNG	81	06/13	→				FCP4697	ATE	
1.4 TGI CNG	81	06/13	→				FCP4434	ATE	For PR code:1KE
1.4 TSI	103	08/12	→	FCP4433	LUCAS/TRW				
1.4 TSI	103	08/12	→	FCP4425	LUCAS/TRW	For PR : 1LJ, 1LM - Sport package option			
1.4 TSI	103	08/12	→				FCP4697	ATE	
1.4 TSI	103	08/12	→				FCP4434	ATE	Disc Diam mm:272,For PR code:1KE
1.4 TSI	110	05/14	→	FCP4433	TRW	Disc Diam mm:288,For PR code:1ZE			
1.4 TSI	110	05/14	→				FCP4434	ATE	Disc Diam mm:272,For PR code:1KE
1.4 TSI	90	11/12	→	FCP4433	LUCAS/TRW				
1.4 TSI	90	11/12	→				FCP4434	ATE	Disc Diam mm:272,For PR code:1KE
1.4 TSI	92	05/14	→	FCP4433	TRW	Disc Diam mm:288,For PR code:1ZE			
1.4 TSI	92	05/14	→				FCP4434	ATE	Disc Diam mm:272,For PR code:1KE
1.4 TSI MultiFuel	90	04/13	→	FCP4433	LUCAS/TRW				
1.4 TSI MultiFuel	90	04/13	→	FCP4425	LUCAS/TRW	PR 1LJ - Sport package option			
1.4 TSI MultiFuel	90	04/13	→				FCP4697	ATE	
1.4 TSI MultiFuel	90	04/13	→				FCP4434	ATE	Disc Diam mm:272,For PR code:1KE
1.4 TSI MultiFuel	92	12/13	→	FCP4433	TRW	Disc Diam mm:312,For PR code:1ZA/1ZB			
1.4 TSI MultiFuel	92	12/13	→				FCP4434	ATE	Disc Diam mm:272,For PR code:1KE
1.6	81	05/14	→	FCP4433	TRW	Disc Diam mm:288,For PR code:1ZE			
1.6	81	05/14	→				FCP4434	ATE	For PR code:1KE
1.6 TDI	66	04/13	→	FCP4433	LUCAS/TRW				
1.6 TDI	66	04/13	→				FCP4434	ATE	For PR code:1KE
1.6 TDI	77	08/12	→				FCP4434	ATE	For PR code:1KE
1.6 TDI	77	11/12	→	FCP4433	LUCAS/TRW				
1.6 TDI	81	01/13	→	FCP4433	LUCAS/TRW				
1.6 TDI	81	01/13	→				FCP4434	ATE	For PR code:1KE
1.6 TDI	85	11/16	→				FCP4434	ATE	For PR code:1KE
1.6 TDI 4motion	77	11/12	→	FCP4433	LUCAS/TRW				
1.6 TDI 4motion	77	11/12	→				FCP4434	ATE	For PR code:1KE
1.6 TDI 4motion	81	01/13	→	FCP4433	LUCAS/TRW				
1.6 TDI 4motion	81	01/13	→				FCP4434	ATE	For PR code:1KE
2.0 GTD	135	04/13	→	FCP4425	LUCAS/TRW	PR 1LK - Sport package option			
2.0 GTD	135	04/13	→	FCP4433	LUCAS/TRW				
2.0 GTD	135	04/13	→				FCP4697	ATE	Disc Diam mm:300,For PR code:1KV
2.0 GTD	135	04/13	→				FCP4434	ATE	Disc Diam mm:272,For PR code:1KE
2.0 GTI Clubsport S	228	09/16	→	FCP4433	TRW				
2.0 GTI Clubsport S	228	09/16	→				FCP4434	ATE	
2.0 TDI	105	08/12	→	FCP4433	LUCAS/TRW				
2.0 TDI	105	08/12	→				FCP4434	ATE	Disc Diam mm:272,For PR code:1KR
2.0 TDI	110	11/12	→	FCP4433	LUCAS/TRW				
2.0 TDI	110	11/12	→				FCP4434	ATE	Disc Diam mm:272,For PR code:1KE
2.0 TDI	81	11/12	→	FCP4433	LUCAS/TRW				
2.0 TDI	81	11/12	→				FCP4434	ATE	For PR code:1KE
2.0 TDI 4motion	110	11/12	→	FCP4433	LUCAS/TRW				
2.0 TDI 4motion	110	11/12	→				FCP4434	ATE	Disc Diam mm:272,For PR code:1KE
e-Golf	100	12/16	→	FCP4433	TRW	For PR code:1ZE			
e-Golf	100	12/16	→				FCP4434	ATE	For PR code:1KE
e-Golf	85	03/14	→ 02/17	FCP4433	TRW	For PR code:1ZE			
e-Golf	85	03/14	→ 02/17				FCP4434	ATE	For PR code:1KE

For material availability see page 16-18 / Per la disponibilità materiali vedere a pagina 16-18



KW



...VOLKSWAGEN

GOLF VII Estate (BA5)

2.0 R 4motion	206	03/15	→	FCP4425	LUCAS/TRW	Pr Number 1LM
2.0 R 4motion	206	03/15	→			
2.0 R 4motion	221	03/15	→	FCP4425	LUCAS/TRW	Pr Number 1LM
2.0 R 4motion	221	03/15	→			

Golf VII Variant (BA5)

1.4 TSI BiFuel	81	09/13	→	FCP4425	LUCAS/TRW	PR 1LJ,1LM
1.4 TSI CNG	81	09/13	→	FCP4433	LUCAS/TRW	

GOLF VII Variant (BA5, BV5)

1.0 TSI	63	01/17	→	FCP4433	TRW	Disc Diam mm:288,For PR code:1ZE			
1.0 TSI	63	01/17	→				FCP4434	ATE	For PR code:1KE
1.0 TSI	81	11/16	→	FCP4433	TRW	Disc Diam mm:288,For PR code:1ZE			
1.0 TSI	81	11/16	→				FCP4434	ATE	For PR code:1KE
1.0 TSI	85	05/15	→				FCP4434	ATE	For PR code:1KE
1.2 TSI	63	05/13	→	FCP4433	LUCAS/TRW				
1.2 TSI	63	05/13	→				FCP4434	ATE	For PR code:1KE
1.2 TSI	77	05/13	→	FCP4433	LUCAS/TRW	For Pr number 1ZA,1ZB,1ZD,1ZE,1ZP,1LV			
1.2 TSI	77	05/13	→	FCP4425	LUCAS/TRW	1LM			
1.2 TSI	77	05/13	→				FCP4697	ATE	For Pr number 1KV,1KY
1.2 TSI	77	05/13	→				FCP4434	ATE	For PR code:1KE
1.2 TSI	81	04/14	→				FCP4434	ATE	For PR code:1KE
1.4 TGI CNG	81	09/13	→	FCP4425	LUCAS/TRW	PR 1LJ,1LM			
1.4 TGI CNG	81	09/13	→				FCP4434	ATE	For PR code:1KE
1.4 TSI	103	05/13	→	FCP4433	TRW	Disc Diam mm:288,For PR code:1ZE			
1.4 TSI	103	05/13	→				FCP4434	ATE	Disc Diam mm:272,For PR code:1KE
1.4 TSI	110	05/14	→	FCP4425	LUCAS/TRW	PR 1LJ,1LM			
1.4 TSI	110	05/14	→				FCP4434	ATE	Disc Diam mm:272,For PR code:1KE
1.4 TSI	90	05/13	→	FCP4425	LUCAS/TRW	PR 1LJ,1LM			
1.4 TSI	90	05/13	→				FCP4434	ATE	Disc Diam mm:272,For PR code:1KE
1.4 TSI	92	05/14	→	FCP4425	LUCAS/TRW	PR 1LJ,1LM			
1.4 TSI	92	05/14	→				FCP4434	ATE	Disc Diam mm:272,For PR code:1KE
1.4 TSI MultiFuel	90	04/13	→	FCP4433	TRW	Disc Diam mm:288,For PR code:1ZE			
1.4 TSI MultiFuel	90	04/13	→				FCP4434	ATE	Disc Diam mm:272,For PR code:1KE
1.4 TSI MultiFuel	92	05/14	→	FCP4425	LUCAS/TRW	PR 1LJ,1LM			
1.4 TSI MultiFuel	92	05/14	→				FCP4434	ATE	Disc Diam mm:272,For PR code:1KE
1.6	81	05/14	→	FCP4433	TRW	Disc Diam mm:288,For PR code:1ZE			
1.6	81	05/14	→				FCP4434	ATE	For PR code:1KE
1.6 TDI	66	05/13	→	FCP4433	LUCAS/TRW				
1.6 TDI	66	05/13	→				FCP4434	ATE	For PR code:1KE
1.6 TDI	77	05/13	→	FCP4433	LUCAS/TRW				
1.6 TDI	77	05/13	→				FCP4434	ATE	For PR code:1KE
1.6 TDI	81	05/13	→	FCP4433	LUCAS/TRW				
1.6 TDI	81	05/13	→				FCP4434	ATE	For PR code:1KE
1.6 TDI	85	11/16	→	FCP4433	TRW	Disc Diam mm:288,For PR code:1ZE			
1.6 TDI	85	11/16	→				FCP4434	ATE	For PR code:1KE
1.6 TDI 4motion	77	05/13	→	FCP4433	LUCAS/TRW				
1.6 TDI 4motion	77	05/13	→				FCP4434	ATE	For PR code:1KE
1.6 TDI 4motion	81	05/13	→	FCP4433	TRW	Disc Diam mm:288,For PR code:1ZE			
1.6 TDI 4motion	81	05/13	→				FCP4434	ATE	For PR code:1KE
2.0 GTD	135	01/15	→	FCP4433	LUCAS/TRW	Pr number 1ZA,1ZB,1ZD,1ZE,1ZP,1LV			
2.0 GTD	135	01/15	→	FCP4425	LUCAS/TRW	For Pr number 1LM - Sport package option			
2.0 GTD	135	01/15	→				FCP4697	ATE	Disc Diam mm:300,For PR code:1KV
2.0 GTD	135	01/15	→				FCP4434	ATE	Disc Diam mm:272,For PR code:1KE
2.0 TDI	110	04/13	→	FCP4433	LUCAS/TRW	For Pr number 1ZA,1ZB,1ZD,1ZE,1ZP,1LV			
2.0 TDI	110	04/13	→	FCP4425	LUCAS/TRW	For Pr number 1LM			
2.0 TDI	110	04/13	→	FCP4697	ATE	For Pr number 1KV,1KY			
2.0 TDI	110	04/13	→				FCP4434	ATE	Disc Diam mm:272,For PR code:1KE
2.0 TDI	81	05/13	→	FCP4433	TRW	Disc Diam mm:288,For PR code:1ZE			
2.0 TDI	81	05/13	→				FCP4434	ATE	For PR code:1KE
2.0 TDI 4motion	110	04/13	→	FCP4433	TRW	Disc Diam mm:288,For PR code:1ZE			
2.0 TDI 4motion	110	04/13	→				FCP4434	ATE	Disc Diam mm:272,For PR code:1KE

Jetta

1.1	37	01/80	→ 11/83	FCP105	ATE				
1.1	37	12/83	→	FCP385	KELGATE				
1.3	43, 44	01/80	→ 11/83	FCP105	ATE				
1.3	37	11/83	→ 12/92	FCP385	KELGATE				
1.3	37	08/87	→ 12/92	FCP385	KELGATE				
1.3	40	11/83	→ 12/92	FCP385	KELGATE				
1.3	40	08/87	→ 12/92	FCP385	KELGATE				
1.3	44	11/83	→ 12/92	FCP385	KELGATE				
1.3	44	08/87	→ 12/92	FCP385	KELGATE				
1.3 Auto	40	11/83	→ 12/92	FCP419	KELGATE				
1.3 Auto	40	08/87	→ 12/92	FCP419	KELGATE				
1.3 i	37	01/89	→ 12/92	FCP385	KELGATE				
1.3 i	40	01/89	→ 12/92	FCP385	KELGATE				

For material availability see page 16-18 / Per la disponibilità materiali vedere a pagina 16-18



KW



...VOLKSWAGEN

...Jetta

					NOTE			NOTE
1.3 i	44	01/89 → 12/92	FCP385	KELGATE				
1.3 i Auto	40	01/89 → 12/92	FCP419	KELGATE				
1.5	51	01/80 → 11/83	FCP419	KELGATE				
1.5 D	37	01/79 → 12/83	FCP105	ATE				
1.6 D	40, 51	01/81 → 11/83	FCP105	ATE				
1.6 i	63, 81	01/80 → 11/83	FCP392	KELGATE				
1.6 TD	51, 59	01/81 → 12/82	FCP419	KELGATE				
1.6 TD	51, 59	11/83 → 08/89	FCP385	KELGATE				
1.6 TD	51, 59	08/89 → 12/92	FCP419	KELGATE				
1.8	66, 82	11/83 → 12/92	FCP419	KELGATE				
1.8	82	01/80 → 11/83	FCP392	KELGATE				
1.8 GT	66, 72	11/83 → 12/92	FCP392	KELGATE				
1.8 GT	66, 72	11/83 → 12/92				FCP541	LUCAS/TRW	
1.8 GT 16V	95, 102	11/83 → 08/88	FCP392	KELGATE				
1.8 GT 16V	95, 102	11/83 → 08/88				FCP541	LUCAS/TRW	
1.8 GT 16V	95, 102	08/88 → 12/91	FCP774	LUCAS/TRW				
1.8 GT 16V	95, 102	08/88 → 12/91				FCP541	LUCAS/TRW	
1.8 Syncro	66, 72	01/86 → 07/89	FCP419	KELGATE				

Jetta (III)

1.4 TSi 16v (1K2)	103	07/06 → 06/08	FCP1641	ATE	PR 1ZP, 1ZE			
1.4 TSi 16v (1K2)	103	07/06 → 06/08				FCP4316	BOSCH	
1.4 TSi 16v (1K2)	118	07/08 → 10/10	FCP1641	ATE	PR 1ZP/1ZD/1LV, 1LJ, 1ZE			
1.4 TSi 16v (1K2)	118	07/08 → 10/10				FCP4316	BOSCH	
1.4 TSi 16v (1K2)	125	07/06 → 06/08	FCP1641	ATE	PR 1ZD/1LV, 1LJ			
1.4 TSi 16v (1K2)	125	07/06 → 06/08				FCP4316	BOSCH	
1.4 TSi 16v (1K2)	90	07/07 → 10/10	FCP1641	ATE	PR 1ZP, 1ZE, 1ZA			
1.4 TSi 16v (1K2)	90	07/07 → 10/10				FCP4316	BOSCH	
1.6 FSi 16v (1K2)	85	09/05 → 06/08	FCP1094	ATE	PR 1ZM			
1.6 FSi 16v (1K2)	85	09/05 → 06/08				FCP4316	BOSCH	
2.0 FSi 16v (1K2)	110	08/05 → 06/08	FCP1641	ATE	PR 1ZP, 1ZE			
2.0 FSi 16v (1K2)	110	08/05 → 06/08				FCP4316	BOSCH	
2.0 FSi/TFSi 16v (1K2)	147	09/05 → 10/10	FCP1641	ATE	PR 1ZD/1LV, 1LJ			
2.0 FSi/TFSi 16v (1K2)	147	09/05 → 10/10				FCP4316	BOSCH	
2.0 TDi 16v (1K2)	100	09/05 → 09/10	FCP1641	ATE	PR 1ZP, 1ZE			
2.0 TDi 16v (1K2)	100	09/05 → 09/10				FCP4316	BOSCH	
2.0 TDi 16v (1K2)	103	08/05 → 10/10	FCP1641	ATE	PR 1ZP, 1ZE			
2.0 TDi 16v (1K2)	103	08/05 → 10/10				FCP4316	BOSCH	
2.0 TDi 16v (1K2)	125	06/06 → 10/10	FCP1641	ATE	PR 1ZD/1LV, 1LJ			
2.0 TDi 16v (1K2)	125	06/06 → 10/10				FCP4316	BOSCH	
2.0 TDi 8v (1K2)	103	10/05 → 06/08	FCP1641	ATE	PR 1ZP, 1ZE			
2.0 TDi 8v (1K2)	103	10/05 → 06/08				FCP4316	BOSCH	
2.5 20v (1K2)	125	07/07 → 10/10	FCP1641	ATE	PR 1ZD/1LV, 1LJ			
2.5 20v (1K2)	125	07/07 → 10/10				FCP4316	BOSCH	
2.5 FSi 20v (1K2)	110	01/05 → 06/08	FCP1641	ATE	PR 1ZP, 1ZE			
2.5 FSi 20v (1K2)	110	01/05 → 06/08				FCP4316	BOSCH	

Jetta (IV)

1.4 TSi 16v (162)	118	04/11 →	FCP1641	ATE	PR 1ZA			
1.4 TSi 16v (162)	118	04/11 →				FCP4316	BOSCH	
2.0 TDi 16v (162)	103	07/10 →	FCP1641	ATE	PR 1ZE			
2.0 TDi 16v (162)	103	07/10 →				FCP4316	BOSCH	
2.0 TFSi 16v (162)	147	12/10 →	FCP1641	ATE	PR 1ZA/1ZB			
2.0 TFSi 16v (162)	147	12/10 →				FCP4316	BOSCH	

JETTA I (16)

1.6	55	08/81 → 07/83	FCP419	KELGATE				
1.6	63	08/78 → 02/84	FCP419	KELGATE				
1.6	55	08/82 → 07/83	FCP419	KELGATE				

JETTA II (19E, 1G2, 165)

1.6	51	10/86 → 10/91	FCP419	KELGATE				
1.6	53	03/86 → 10/91	FCP419	KELGATE				
1.6	55	01/84 → 07/92	FCP419	KELGATE				

Lupo

1.0	37	10/98 →	FCP1101	ATE				
1.4 16V	55, 74	10/98 →	FCP1101	ATE				
1.6 GTI	92	09/00 → 07/05	FCP1312	LUCAS/TRW				
1.7 SDi	42	10/98 →	FCP1101	ATE				

For material availability see page 16-18 / Per la disponibilità materiali vedere a pagina 16-18

1242

FERODO

RACING

Updated on 17th Aug 2018

VOLKSWAGEN



KW



...VOLKSWAGEN

PASSAT

					NOTE			NOTE
1.3 Auto,Variant	44	01/73 → 10/79	FCP105	ATE				
1.3 Auto,Variant	44	11/79 → 07/85	FCP419	KELGATE				
1.3 Manual Saloon	40, 44	01/73 → 10/79	FCP105	ATE				
1.3 Manual Saloon	40, 44	11/79 → 12/83	FCP419	KELGATE				
1.5	63	01/73 → 10/79	FCP105	ATE				
1.6		01/73 → 10/79	FCP105	ATE				
1.6	74	10/96 → 07/00	FCP1289	LUCAS/TRW				
1.6	74	10/96 → 07/00				FCP596	LUCAS/TRW	
1.6	74	10/97 → 07/00	FCP1289	LUCAS/TRW				
1.6	74	10/97 → 07/00				FCP541	LUCAS/TRW	
1.6	51	01/84 → 10/93	FCP419	KELGATE				
1.6	53	01/84 → 10/93	FCP419	KELGATE				
1.6	55	11/79 → 12/83	FCP419	KELGATE				
1.6	55	01/84 → 10/93	FCP419	KELGATE				
1.6	63	11/79 → 12/83	FCP419	KELGATE				
1.6	81	11/79 → 12/83	FCP419	KELGATE				
1.6 D Saloon	40, 51	04/88 → 08/89	FCP775	LUCAS/TRW				
1.6 D Saloon/Variant	40, 51	01/84 → 03/88	FCP419	KELGATE				
1.6 GLI Auto,Variant	81	11/79 → 12/83	FCP419	KELGATE				
1.6 TD Saloon	51, 59	01/84 → 07/90	FCP419	KELGATE				
1.6 TD Saloon	51, 59	08/90 → 10/93	FCP775	LUCAS/TRW				
1.6 TD SW Estate	40, 51	01/84 → 07/90	FCP419	KELGATE				
1.8		10/93 → 10/96	FCP775	LUCAS/TRW				
1.8 Auto, Manual, Saloon, Variant		11/79 → 12/83	FCP419	KELGATE				
1.8 Saloon	55, 66	04/88 → 08/89	FCP775	LUCAS/TRW				
1.8 Saloon	68, 82	09/89 → 10/93	FCP775	LUCAS/TRW				
1.8 Saloon 20V	92	10/96 → 11/00	FCP775	LUCAS/TRW				
1.8 Saloon 20V	92	10/96 → 11/00				FCP541	LUCAS/TRW	
1.8 Saloon Turbo 20V		10/96 → 11/00	FCP1323	ATE				
1.8 Saloon Turbo 20V		10/96 → 11/00				FCP541	LUCAS/TRW	
1.8 Saloon, Variant	66, 68	01/84 → 03/88	FCP419	KELGATE				
1.8 SW Estate		04/88 → 10/93	FCP775	LUCAS/TRW				
1.8 Variant 20V	92	10/97 → 11/00	FCP1289	LUCAS/TRW				
1.8 Variant 20V	92	10/97 → 11/00				FCP541	LUCAS/TRW	
1.8 Variant Turbo 20V	110	01/97 → 11/00	FCP1323	ATE				
1.8 Variant Turbo 20V	110	01/97 → 11/00	FCP1289	LUCAS/TRW				
1.8 Variant Turbo 20V	110	01/97 → 11/00				FCP541	LUCAS/TRW	
1.9		01/88 → 03/88	FCP419	KELGATE				
1.9		04/88 → 08/89	FCP775	LUCAS/TRW				
1.9 D	50	09/89 → 10/96	FCP775	LUCAS/TRW				
1.9 D , Variant	55, 66	09/89 → 10/96	FCP775	LUCAS/TRW				
1.9 GL5		09/81 → 12/83	FCP419	KELGATE				
1.9 TDi Saloon	66	10/96 → 11/00	FCP1289	ATE				
1.9 TDi Saloon	66	10/96 → 11/00				FCP541	LUCAS/TRW	
1.9 TDi Saloon	81, 85	10/96 → 11/00	FCP1323	ATE				
1.9 TDi Saloon	81, 85	10/96 → 11/00	FCP1289	LUCAS/TRW				
1.9 TDi Saloon	81, 85	10/96 → 11/00				FCP596	LUCAS/TRW	
1.9 TDi Saloon	81, 85	10/96 → 11/00				FCP541	LUCAS/TRW	
1.9 TDi Variant	66	10/97 → 11/00	FCP1323	ATE				
1.9 TDi Variant	66	10/97 → 11/00	FCP1289	LUCAS/TRW				
1.9 TDi Variant	66	10/97 → 11/00				FCP541	LUCAS/TRW	
1.9 TDi Variant	81	10/97 → 11/00	FCP1323	ATE				
1.9 TDi Variant	81	10/97 → 11/00	FCP1289	LUCAS/TRW				
1.9 TDi Variant	81	10/97 → 11/00				FCP541	LUCAS/TRW	
2.0	85	04/88 → 10/93	FCP774	LUCAS/TRW				
2.0	85	04/88 → 10/93				FCP541	LUCAS/TRW	
2.0	85	10/93 → 10/96	FCP774	LUCAS/TRW				
2.0	85	10/93 → 10/96				FCP541	LUCAS/TRW	
2.0 16V	100	04/88 → 10/93	FCP774	LUCAS/TRW				
2.0 16V	100	04/88 → 10/93				FCP541	LUCAS/TRW	
2.0 16V	110	10/93 → 10/96	FCP590	ATE				
2.0 16V	110	10/93 → 10/96				FCP541	LUCAS/TRW	
2.0 GL5	84	08/83 → 03/88	FCP419	KELGATE				
2.2	85, 100	01/84 → 03/88	FCP419	KELGATE				
2.2 GT5		10/80 → 03/88	FCP774	LUCAS/TRW				
2.2 GT5		10/80 → 03/88				FCP541	LUCAS/TRW	
2.3 VR5	110	01/97 →	FCP1323	ATE				
2.3 VR5	110	01/97 →				FCP541	LUCAS/TRW	
2.5 TDi Syncro, Variant 24V	110	12/98 →	FCP1323	ATE				
2.5 TDi Syncro, Variant 24V	110	12/98 →				FCP541	LUCAS/TRW	
2.8 V6 30V	142	01/97 →	FCP1323	ATE				
2.8 V6 30V	142	01/97 →	FCP1289	LUCAS/TRW				
2.8 V6 30V	142	01/97 →				FCP541	LUCAS/TRW	
2.8 VR6	128	04/88 → 10/93	FCP775	LUCAS/TRW				
2.8 VR6	128	04/88 → 10/93				FCP541	LUCAS/TRW	
2.8 VR6	128	10/93 → 10/96	FCP590	ATE				
2.8 VR6	128	10/93 → 10/96				FCP541	LUCAS/TRW	
2.9 VR6	135	10/93 → 11/96	FCP590	ATE				

VOLKSWAGEN

For material availability see page 16-18 / Per la disponibilità materiali vedere a pagina 16-18



KW



...VOLKSWAGEN

PASSAT (362)

				NOTE			NOTE
1.4 TSI	90	08/10 →	FCP4425	LUCAS/TRW			
1.4 TSI	90	08/10 →				FCP1636	LUCAS/TRW
1.4 TSI	90	08/10 →				FCP4316	BOSCH
1.6 TDI	77	08/10 →	FCP4425	LUCAS/TRW			
1.6 TDI	77	08/10 →				FCP1636	LUCAS/TRW
1.6 TDI	77	08/10 →				FCP4316	BOSCH
1.8 TSI	118	08/10 →	FCP4425	LUCAS/TRW			
1.8 TSI	118	08/10 →				FCP1636	LUCAS/TRW
1.8 TSI	118	08/10 →				FCP4316	BOSCH
2.0 TDI	100	08/10 →	FCP4425	LUCAS/TRW			
2.0 TDI	100	08/10 →				FCP1636	LUCAS/TRW
2.0 TDI	100	08/10 →				FCP4316	BOSCH
2.0 TDI	103	08/10 →	FCP4425	LUCAS/TRW			
2.0 TDI	103	08/10 →				FCP1636	LUCAS/TRW
2.0 TDI	103	08/10 →				FCP4316	BOSCH
2.0 TDI	125	08/10 →	FCP4425	LUCAS/TRW			
2.0 TDI	125	08/10 →				FCP1636	LUCAS/TRW
2.0 TDI	125	08/10 →				FCP4316	BOSCH
2.0 TDI 4motion	103	08/10 →	FCP4425	LUCAS/TRW			
2.0 TDI 4motion	103	08/10 →				FCP1636	LUCAS/TRW
2.0 TDI 4motion	103	08/10 →				FCP4316	BOSCH
2.0 TDI 4motion	125	08/10 →	FCP4425	LUCAS/TRW			
2.0 TDI 4motion	125	08/10 →				FCP1636	LUCAS/TRW
2.0 TDI 4motion	125	08/10 →				FCP4316	BOSCH
2.0 TSI	155	11/10 →	FCP4425	LUCAS/TRW			
2.0 TSI	155	11/10 →				FCP1636	LUCAS/TRW
2.0 TSI	155	11/10 →				FCP4316	BOSCH
3.6 FSI 4motion	220	01/11 →	FCP4425	LUCAS/TRW			
3.6 FSI 4motion	220	01/11 →				FCP1636	LUCAS/TRW
3.6 FSI 4motion	220	01/11 →				FCP4316	BOSCH

PASSAT (3A2, 35I)

1.8	79	04/88 → 07/93	FCP774	LUCAS/TRW			
1.8	79	04/88 → 07/93				FCP541	LUCAS/TRW
1.8	82	04/88 → 07/92	FCP774	LUCAS/TRW			
1.8	82	04/88 → 07/92				FCP541	LUCAS/TRW
1.8 16V	100	04/88 → 12/89	FCP774	LUCAS/TRW			
1.8 16V	100	04/88 → 12/89				FCP541	LUCAS/TRW

PASSAT (3B2)

1.9 TDI	74	02/00 → 11/00	FCP1717	ATE	PR 1LT(312mm disc)		
1.9 TDI	74	02/00 → 11/00				FCP1491	LUCAS/TRW
2.0	88	04/00 → 11/00	FCP1717	ATE	PR 1LT(312mm disc)		
2.0	88	04/00 → 11/00				FCP1491	LUCAS/TRW
2.0 4motion	88	04/00 → 11/00	FCP1717	ATE	PR 1LT(312mm disc)		
2.0 4motion	88	04/00 → 11/00				FCP1491	LUCAS/TRW

PASSAT (3B3)

1.6	75	11/00 → 05/05	FCP1717	ATE	PR 1LT(312mm disc)		
1.6	75	11/00 → 05/05				FCP1491	LUCAS/TRW
1.8	92	03/03 → 03/05	FCP1717	ATE	PR 1LT(312mm disc)		
1.8	92	03/03 → 03/05				FCP1491	LUCAS/TRW
1.8 T	125	02/01 → 05/05	FCP1717	ATE	PR 1LT(312mm disc)		
1.8 T	125	02/01 → 05/05				FCP1491	LUCAS/TRW
1.8 T 20V	110	11/00 → 05/05	FCP1717	ATE	PR 1LT(312mm disc)		
1.8 T 20V	110	11/00 → 05/05				FCP1491	LUCAS/TRW
1.8 T 4motion	125	03/01 → 05/05	FCP1717	ATE	PR 1LT(312mm disc)		
1.8 T 4motion	125	03/01 → 05/05				FCP1491	LUCAS/TRW
1.9 TDI	74	11/00 → 05/05	FCP1717	ATE			
1.9 TDI	74	11/00 → 05/05				FCP1491	LUCAS/TRW
1.9 TDI	96	11/00 → 05/05	FCP1717	ATE			
1.9 TDI	96	11/00 → 05/05				FCP1491	LUCAS/TRW
1.9 TDI 4motion	96	11/00 → 05/05	FCP1717	ATE			
1.9 TDI 4motion	96	11/00 → 05/05				FCP1491	LUCAS/TRW
2.0	85	11/00 → 05/05	FCP1717	ATE			
2.0	85	11/00 → 05/05				FCP1491	LUCAS/TRW
2.0	96	11/01 → 05/05	FCP1717	ATE			
2.0	96	11/01 → 05/05				FCP1491	LUCAS/TRW
2.0 4motion	85	11/00 → 05/05	FCP1717	ATE			
2.0 4motion	85	11/00 → 05/05				FCP1491	LUCAS/TRW
2.0 TDI	100	12/03 → 05/05	FCP1717	ATE			
2.0 TDI	100	12/03 → 05/05				FCP1491	LUCAS/TRW
2.3 V5	125	11/00 → 05/05	FCP1717	ATE	PR 1LT(312mm disc)		
2.3 V5	125	11/00 → 05/05				FCP1491	LUCAS/TRW
2.3 V5 4motion	125	11/00 → 05/05	FCP1717	ATE	PR 1LT(312mm disc)		
2.3 V5 4motion	125	11/00 → 05/05				FCP1491	LUCAS/TRW
2.5 TDI	110	11/00 → 05/05	FCP1717	ATE	PR 1LT(312mm disc)		

For material availability see page 16-18 / Per la disponibilità materiali vedere a pagina 16-18

1244

FERODO

RACING

Updated on 17th Aug 2018

VOLKSWAGEN



KW

**...VOLKSWAGEN****...PASSAT (3B3)**

					NOTE			NOTE
2.5 TDI	110	11/00 → 05/05				FCP1491	LUCAS/TRW	
2.5 TDI	120	05/03 → 05/05	FCP1717	ATE				
2.5 TDI	120	05/03 → 05/05				FCP1491	LUCAS/TRW	
2.5 TDI 4motion	110	11/00 → 05/05	FCP1717	ATE				
2.5 TDI 4motion	110	11/00 → 05/05				FCP1491	LUCAS/TRW	
2.5 TDI 4motion	132	01/03 → 05/05	FCP1717	ATE				
2.5 TDI 4motion	132	01/03 → 05/05				FCP1491	LUCAS/TRW	
2.8 4motion	142	11/00 → 05/05	FCP1717	ATE				
2.8 4motion	142	11/00 → 05/05				FCP1491	LUCAS/TRW	
4.0 W8 4motion	202	09/01 → 09/04	FCP1001	ATE	PR 1LC			
4.0 W8 4motion	202	09/01 → 09/04				FCP1491	LUCAS/TRW	

PASSAT (3C2)

2.0 FSI	147	07/05 → 07/10	FCP1765	ATE				
2.0 FSI	147	07/05 → 07/10				FCP1636	LUCAS/TRW	
3.2 FSI 4motion	184	11/05 → 07/10	FCP1765	ATE	For PR code:1LK/1LM			
3.2 FSI 4motion	184	11/05 → 07/10	FCP4223	ATE				
3.2 FSI 4motion	184	11/05 → 07/10				FCP1636	LUCAS/TRW	For PR code:2EA
3.6 FSI	206	06/05 → 07/10	FCP4223	ATE				
3.6 FSI	206	06/05 → 07/10	FCP1765	ATE				
3.6 FSI	206	06/05 → 07/10				FCP1636	LUCAS/TRW	
3.6 FSI 4motion	206	09/05 → 07/10	FCP4223	ATE				
3.6 FSI 4motion	206	09/05 → 07/10	FCP1765	ATE				
3.6 FSI 4motion	206	09/05 → 07/10				FCP1636	LUCAS/TRW	
3.6 R36 4motion	220	04/07 → 07/10	FCP4223	ATE				
3.6 R36 4motion	220	04/07 → 07/10	FCP1765	ATE	For PR code:1LK/1LM			
3.6 R36 4motion	220	04/07 → 07/10				FCP1636	LUCAS/TRW	For PR code:2EL

PASSAT (3G2)

1.4 GTE Hybrid	115	11/14 →	FCP4425	LUCAS/TRW	Pr Number 1LA			
1.4 GTE Hybrid	115	11/14 →	FCP4433	LUCAS/TRW	Pr Number 1ZA			
1.4 GTE Hybrid	115	11/14 →				FCP4697	ATE	For PR code:1KU/1KZ
1.4 TSI	110	11/14 →	FCP4433	LUCAS/TRW				
1.4 TSI	110	11/14 →				FCP4697	ATE	For PR code:1KU/1KZ
1.4 TSI	92	11/14 →	FCP4433	LUCAS/TRW				
1.4 TSI	92	11/14 →				FCP4697	ATE	For PR code:1KU/1KZ
1.4 TSI 4motion	110	02/15 →	FCP4425	LUCAS/TRW	Pr Number 1LA			
1.4 TSI 4motion	110	02/15 →	FCP4433	LUCAS/TRW	Pr Number 1ZA			
1.4 TSI 4motion	110	02/15 →				FCP4697	ATE	For PR code:1KU/1KZ
1.6 TDI	88	08/14 →	FCP4433	LUCAS/TRW				
1.6 TDI	88	08/14 →				FCP4697	ATE	For PR code:1KU/1KZ
1.8 TSI	132	02/15 →	FCP4425	LUCAS/TRW	Pr Number 1LA			
1.8 TSI	132	02/15 →	FCP4433	LUCAS/TRW	Pr number 1ZA			
1.8 TSI	132	02/15 →				FCP4697	ATE	For PR code:1KU/1KZ
2.0 TDI	110	11/14 →	FCP4433	LUCAS/TRW				
2.0 TDI	110	11/14 →				FCP4697	ATE	For PR code:1KU/1KZ
2.0 TDI	140	11/14 →	FCP4425	LUCAS/TRW	Pr Number 1LA			
2.0 TDI	140	11/14 →	FCP4433	LUCAS/TRW	Pr Number 1ZA			
2.0 TDI	140	11/14 →				FCP4697	ATE	For PR code:1KU/1KZ
2.0 TDI 4motion	110	02/15 →	FCP4425	LUCAS/TRW	Pr Number 1LA			
2.0 TDI 4motion	110	02/15 →	FCP4433	LUCAS/TRW	1ZA			
2.0 TDI 4motion	110	02/15 →				FCP4697	ATE	For PR code:1KU/1KZ
2.0 TDI 4motion	140	11/14 →	FCP4425	LUCAS/TRW	Pr Number 1LA			
2.0 TDI 4motion	140	11/14 →	FCP4433	LUCAS/TRW	Pr Number 1ZA			
2.0 TDI 4motion	140	11/14 →				FCP4697	ATE	For PR code:1KU/1KZ
2.0 TDI 4motion	176	08/14 →	FCP4433	LUCAS/TRW				
2.0 TDI 4motion	176	08/14 →				FCP4697	ATE	For PR code:1KU/1KZ
2.0 TSI	162	02/15 →	FCP4425	LUCAS/TRW	Pr Number 1LA			
2.0 TSI	162	02/15 →	FCP4433	LUCAS/TRW	Pr Number 1ZA			
2.0 TSI	162	02/15 →				FCP4697	ATE	For PR code:1KU/1KZ
2.0 TSI 4motion	206	02/15 →	FCP4425	LUCAS/TRW	Pr Number 1LA			
2.0 TSI 4motion	206	02/15 →	FCP4433	LUCAS/TRW	Pr Number 1ZA,1ZC			
2.0 TSI 4motion	206	05/15 →				FCP4697	ATE	For PR code:1KU/1KZ/2EA

PASSAT (I)

1.3 Auto, SW Estate	44	01/84 → 07/85	FCP419	KELGATE				
1.3 i Auto, SW Estate	44	11/79 → 12/83	FCP392	KELGATE				
1.3 i Saloon	40, 44	01/73 → 10/79	FCP105	ATE				
1.3 i Saloon	40, 44	11/79 → 12/83	FCP419	KELGATE				
1.5 i	63	01/73 → 10/79	FCP105	ATE				
1.6 D Saloon	40, 51	01/84 → 03/88	FCP419	KELGATE				
1.6 D Saloon	40, 51	04/88 → 08/89	FCP775	LUCAS/TRW				
1.6 D SW Estate	40, 51	01/84 → 03/88	FCP419	KELGATE				
1.6 i		01/73 → 10/79	FCP105	ATE				
1.6 i	55, 63	11/79 → 12/83	FCP419	KELGATE				
1.6 i Auto, SW Estate	55	11/79 → 12/83	FCP392	KELGATE				
1.6 i Auto, SW Estate	63	11/79 → 12/83	FCP392	KELGATE				

For material availability see page 16-18 / Per la disponibilità materiali vedere a pagina 16-18



KW

**...VOLKSWAGEN**

NOTE

NOTE

...PASSAT (I)

1.6 i Auto, SW Estate	81	11/79 → 12/83	FCP392	KELGATE
1.6 i GLi Auto, SW Estate	81	11/79 → 12/83	FCP392	KELGATE
1.6 Saloon	51, 53	01/84 → 03/88	FCP419	KELGATE
1.6 SW Estate	55	01/84 → 03/88	FCP419	KELGATE
1.6 TD Saloon	51, 59	01/84 → 03/88	FCP419	KELGATE
1.6 TD SW Estate	40, 51	01/84 → 03/88	FCP419	KELGATE
1.8 i Auto, SW Estate		11/79 → 12/83	FCP419	KELGATE
1.8 i Saloon		11/79 → 12/83	FCP419	KELGATE
1.8 Saloon	66, 68	01/84 → 03/88	FCP419	KELGATE
1.8 SW Estate	66	01/84 → 03/88	FCP419	KELGATE
1.9		01/88 → 03/88	FCP392	KELGATE
1.9 i GL5		09/81 → 12/83	FCP392	KELGATE
2.0	84	01/84 → 03/88	FCP392	KELGATE
2.0 GL5		08/83 → 12/83	FCP392	KELGATE
2.2	85, 100	01/84 → 03/88	FCP392	KELGATE
2.2 GT5		10/80 → 03/88	FCP774	LUCAS/TRW
2.2 GT5		10/80 → 03/88		

FCP541 LUCAS/TRW

PASSAT (II)

1.6 Saloon	53, 55	04/88 → 09/91	FCP419	KELGATE
1.6 Saloon	53, 55	04/88 → 09/91	FCP775	LUCAS/TRW
1.6 Saloon, Variant	74	07/94 → 08/96	FCP774	LUCAS/TRW
1.6 Saloon, Variant	74	07/94 → 08/96	FCP775	LUCAS/TRW
1.6 TD Saloon, Variant	51, 59	04/88 → 09/93	FCP775	LUCAS/TRW
1.6 Variant	53, 55	04/88 → 09/91	FCP775	LUCAS/TRW
1.8 GT, GL Saloon	100	04/88 → 10/93	FCP774	LUCAS/TRW
1.8 GT, GL Saloon	100	04/88 → 10/93		
1.8 GT, GL Saloon	79, 82	04/88 → 10/93	FCP774	LUCAS/TRW
1.8 GT, GL Saloon	79, 82	04/88 → 10/93		
1.8 i G60 Syncro, Saloon, Variant	118	08/88 → 08/96	FCP775	LUCAS/TRW
1.8 i G60 Syncro, Saloon, Variant	118	08/88 → 08/96		
1.8 Saloon, Variant	55, 66	04/88 → 08/96	FCP775	LUCAS/TRW
1.9 TDi Saloon, Variant	66	10/93 → 08/96	FCP775	LUCAS/TRW
1.9 TDi Saloon, Variant	66	10/93 → 08/96	FCP774	LUCAS/TRW
1.9 TDi Saloon, Variant	81	03/96 → 08/96	FCP775	LUCAS/TRW
2.0 Saloon, Variant	79, 85	02/90 → 08/96	FCP774	LUCAS/TRW
2.0 Saloon, Variant	79, 85	02/90 → 08/96		
2.8 i VR6 Saloon, Variant	128	06/91 → 10/93	FCP775	LUCAS/TRW
2.8 i VR6 Saloon, Variant	128	06/91 → 10/93		

FCP541 LUCAS/TRW

FCP541 LUCAS/TRW

FCP541 LUCAS/TRW

FCP541 LUCAS/TRW

PASSAT (III)

1.6 i Saloon, Variant	74	10/96 → 10/00	FCP1289	LUCAS/TRW
1.8 i Saloon, Variant 20V	92	10/96 → 11/00	FCP1289	LUCAS/TRW
1.9 TDi Saloon, Variant	66, 74	10/96 → 11/00	FCP1289	LUCAS/TRW

PASSAT ALLTRACK (365)

1.8 TSI	112	01/12 →	FCP4425	LUCAS/TRW	PR 1LA,1LB
1.8 TSI	112	01/12 →			
1.8 TSI	112	01/12 →			
1.8 TSI	118	01/12 →	FCP4425	LUCAS/TRW	PR 1LA,1LB
1.8 TSI	118	01/12 →			
1.8 TSI	118	01/12 →			
2.0 TDI	103	01/12 →	FCP4425	LUCAS/TRW	PR 1LA,1LB
2.0 TDI	103	01/12 →			
2.0 TDI	103	01/12 →			
2.0 TDI 4motion	103	01/12 →	FCP4425	LUCAS/TRW	PR 1LA,1LB
2.0 TDI 4motion	103	01/12 →			
2.0 TDI 4motion	103	01/12 →			
2.0 TDI 4motion	125	01/12 →	FCP4425	LUCAS/TRW	PR 1LA,1LB
2.0 TDI 4motion	125	01/12 →			
2.0 TDI 4motion	125	01/12 →			
2.0 TDI 4motion	130	01/13 →	FCP4425	LUCAS/TRW	PR 1LA,1LB
2.0 TDI 4motion	130	01/13 →			
2.0 TDI 4motion	130	01/13 →			
2.0 TSI 4motion	155	01/12 →	FCP4425	LUCAS/TRW	PR 1LA,1LB
2.0 TSI 4motion	155	01/12 →			
2.0 TSI 4motion	155	01/12 →			

FCP1636 LUCAS/TRW

FCP4316 BOSCH

FCP1636 LUCAS/TRW

FCP4316 BOSCH

FCP1636 LUCAS/TRW

FCP4316 BOSCH

FCP1636 LUCAS/TRW

FCP4316 BOSCH

FCP1636 LUCAS/TRW

FCP4316 BOSCH

FCP1636 LUCAS/TRW

FCP4316 BOSCH

FCP1636 LUCAS/TRW

FCP4316 BOSCH

PASSAT ALLTRACK (3G5)

2.0 TDI 4motion	110	11/14 →	FCP4425	LUCAS/TRW	Pr Number 1LA
2.0 TDI 4motion	110	11/14 →	FCP4433	LUCAS/TRW	Pr Number 1ZA
2.0 TDI 4motion	140	11/14 →	FCP4425	LUCAS/TRW	Pr Number 1LA
2.0 TDI 4motion	140	11/14 →	FCP4433	LUCAS/TRW	Pr Number 1ZA
2.0 TDI 4motion	140	11/14 →			
2.0 TDI 4motion	140	11/14 →			
2.0 TDI 4motion	176	11/14 →	FCP4425	LUCAS/TRW	Pr Number 1LA
2.0 TDI 4motion	176	11/14 →	FCP4433	LUCAS/TRW	Pr Number 1ZA
2.0 TDI 4motion	176	11/14 →			

FCP4697 ATE For PR code:1KU/1KZ

FCP4697 ATE For PR code:1KU/1KZ

For material availability see page 16-18 / Per la disponibilità materiali vedere a pagina 16-18

1246

FERODO

RACING

Updated on 17th Aug 2018

VOLKSWAGEN



KW



...VOLKSWAGEN			NOTE			NOTE		
...PASSAT ALLTRACK (3G5)								
2.0 TSI 4motion	162	11/14 →	FCP4425	LUCAS/TRW	Pr Number 1LA			
2.0 TSI 4motion	162	11/14 →	FCP4433	LUCAS/TRW	Pr Number 1ZA			
2.0 TSI 4motion	162	11/14 →				FCP4697	ATE	For PR code:1KU/1KZ
PASSAT CC (357)								
3.6 FSI 4motion	206	06/08 → 01/12	FCP4223	ATE				
3.6 FSI 4motion	206	06/08 → 01/12	FCP1765	ATE				
3.6 FSI 4motion	206	06/08 → 01/12	FCP4425	LUCAS/TRW				
3.6 FSI 4motion	206	06/08 → 01/12				FCP1636	LUCAS/TRW	
3.6 FSI 4motion	220	06/08 → 05/10	FCP4425	LUCAS/TRW	For PR code:1LA			
3.6 FSI 4motion	220	06/08 → 05/10	FCP4223	ATE				
3.6 FSI 4motion	220	06/08 → 05/10	FCP1765	ATE	Disc Diam mm:345,For PR code:1LK			
3.6 FSI 4motion	220	06/08 → 05/10				FCP1636	LUCAS/TRW	For PR code:2EA
PASSAT Variant (33B)								
1.8 Syncro	66	01/86 → 03/88	FCP774	LUCAS/TRW				
1.8 Syncro	66	01/86 → 03/88				FCP541	LUCAS/TRW	
PASSAT Variant (365)								
1.4 TSI	90	08/10 →	FCP4425	LUCAS/TRW				
1.4 TSI	90	08/10 →				FCP1636	LUCAS/TRW	
1.4 TSI	90	08/10 →				FCP4316	BOSCH	
1.6 TDI	77	08/10 →	FCP4425	LUCAS/TRW				
1.6 TDI	77	08/10 →				FCP1636	LUCAS/TRW	
1.6 TDI	77	08/10 →				FCP4316	BOSCH	
1.8 TSI	118	08/10 →	FCP4425	LUCAS/TRW				
1.8 TSI	118	08/10 →				FCP1636	LUCAS/TRW	
1.8 TSI	118	08/10 →				FCP4316	BOSCH	
2.0 TDI	103	08/10 →	FCP4425	LUCAS/TRW				
2.0 TDI	103	08/10 →				FCP1636	LUCAS/TRW	
2.0 TDI	103	08/10 →				FCP4316	BOSCH	
2.0 TDI	125	08/10 →	FCP4425	LUCAS/TRW				
2.0 TDI	125	08/10 →				FCP1636	LUCAS/TRW	
2.0 TDI	125	08/10 →				FCP4316	BOSCH	
2.0 TDI	125	08/10 →	FCP4425	LUCAS/TRW				
2.0 TDI 4motion	103	08/10 →	FCP4425	LUCAS/TRW				
2.0 TDI 4motion	103	08/10 →				FCP1636	LUCAS/TRW	
2.0 TDI 4motion	103	08/10 →				FCP4316	BOSCH	
2.0 TDI 4motion	125	08/10 →	FCP4425	LUCAS/TRW				
2.0 TDI 4motion	125	08/10 →				FCP1636	LUCAS/TRW	
2.0 TDI 4motion	125	08/10 →				FCP4316	BOSCH	
2.0 TSI	155	11/10 →	FCP4425	LUCAS/TRW				
2.0 TSI	155	11/10 →				FCP1636	LUCAS/TRW	
2.0 TSI	155	11/10 →				FCP4316	BOSCH	
3.6 FSI 4motion	220	01/11 →	FCP4425	LUCAS/TRW				
3.6 FSI 4motion	220	01/11 →				FCP1636	LUCAS/TRW	
3.6 FSI 4motion	220	01/11 →				FCP4316	BOSCH	
PASSAT Variant (3A5, 35I)								
1.8	66	02/88 → 05/97				FCP541	LUCAS/TRW	
1.8	79	04/88 → 07/90	FCP774	LUCAS/TRW				
1.8	79	04/88 → 07/90				FCP541	LUCAS/TRW	
1.8	82	04/88 → 07/92	FCP774	LUCAS/TRW				
1.8	82	04/88 → 07/92				FCP541	LUCAS/TRW	
1.8 16V	100	04/88 → 12/89	FCP774	LUCAS/TRW				
1.8 16V	100	04/88 → 12/89				FCP541	LUCAS/TRW	
PASSAT Variant (3B6)								
1.6	75	11/00 → 05/05	FCP1717	ATE	PR 1LT(312mm disc)			
1.6	75	11/00 → 05/05				FCP1491	LUCAS/TRW	
1.8 4motion	125	03/01 → 05/05	FCP1717	ATE	PR 1LT(312mm disc)			
1.8 4motion	125	03/01 → 05/05				FCP1491	LUCAS/TRW	
1.8 T	125	05/02 → 08/05	FCP1717	ATE	PR 1LT(312mm disc)			
1.8 T	125	05/02 → 08/05				FCP1491	LUCAS/TRW	
1.8 T 20V	110	11/00 → 05/05	FCP1717	ATE	PR 1LT(312mm disc)			
1.8 T 20V	110	11/00 → 05/05				FCP1491	LUCAS/TRW	
1.9 TDI	74	11/00 → 05/05	FCP1717	ATE	PR 1LT(312mm disc)			
1.9 TDI	74	11/00 → 05/05				FCP1491	LUCAS/TRW	
1.9 TDI	96	11/00 → 05/05	FCP1717	ATE	PR 1LT(312mm disc)			
1.9 TDI	96	11/00 → 05/05				FCP1491	LUCAS/TRW	
1.9 TDI 4motion	96	11/00 → 05/05	FCP1717	ATE	PR 1LT(312mm disc)			
1.9 TDI 4motion	96	11/00 → 05/05				FCP1491	LUCAS/TRW	
2.0	85	11/00 → 05/05	FCP1717	ATE	PR 1LT(312mm disc)			
2.0	85	11/00 → 05/05				FCP1491	LUCAS/TRW	
2.0	96	11/01 → 05/05	FCP1717	ATE				
2.0	96	11/01 → 05/05				FCP1491	LUCAS/TRW	
2.0 4motion	85	11/00 → 05/05	FCP1717	ATE	PR 1LT(312mm disc)			

VOLKSWAGEN

For material availability see page 16-18 / Per la disponibilità materiali vedere a pagina 16-18



KW

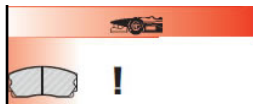

...VOLKSWAGEN

...PASSAT Variant (3B6)

					NOTE			NOTE
2.0 4motion	85	11/00 → 05/05						
2.0 TDI	100	12/03 → 05/05	FCP1717	ATE		FCP1491	LUCAS/TRW	
2.0 TDI	100	12/03 → 05/05				FCP1491	LUCAS/TRW	
2.3 VR5	125	11/00 → 05/05	FCP1717	ATE	PR 1LT(312mm disc)			
2.3 VR5	125	11/00 → 05/05				FCP1491	LUCAS/TRW	
2.3 VR5 4motion	125	11/00 → 05/05	FCP1717	ATE	PR 1LT(312mm disc)			
2.3 VR5 4motion	125	11/00 → 05/05				FCP1491	LUCAS/TRW	
2.5 TDI	110	11/00 → 05/05	FCP1717	ATE	PR 1LT(312mm disc)			
2.5 TDI	110	11/00 → 05/05				FCP1491	LUCAS/TRW	
2.5 TDI	120	05/03 → 05/05	FCP1717	ATE				
2.5 TDI	120	05/03 → 05/05				FCP1491	LUCAS/TRW	
2.5 TDI 4motion	110	11/00 → 05/05	FCP1717	ATE	PR 1LT(312mm disc)			
2.5 TDI 4motion	110	11/00 → 05/05				FCP1491	LUCAS/TRW	
2.5 TDI 4motion	132	01/03 → 05/05	FCP1717	ATE				
2.5 TDI 4motion	132	01/03 → 05/05				FCP1491	LUCAS/TRW	
2.8 4motion	142	11/00 → 05/05	FCP1717	ATE	PR 1LT(312mm disc)			
2.8 4motion	142	11/00 → 05/05				FCP1491	LUCAS/TRW	
4.0 W8 4motion	202	09/01 → 09/04	FCP1001	ATE	PR 1LC			
4.0 W8 4motion	202	09/01 → 09/04				FCP1491	LUCAS/TRW	

PASSAT Variant (3C5)

2.0	100	09/06 → 12/07	FCP1641	ATE				
2.0	100	09/06 → 12/07	FCP4223	ATE				
2.0	100	09/06 → 12/07				FCP1636	LUCAS/TRW	
2.0	86	09/06 → 12/08	FCP4223	ATE				
2.0	86	09/06 → 12/08	FCP1641	ATE				
2.0	86	09/06 → 12/08				FCP1636	LUCAS/TRW	
3.2 FSI 4motion	184	11/05 → 11/10	FCP4223	ATE				
3.2 FSI 4motion	184	11/05 → 11/10	FCP1765	ATE	For PR code:1LK/1LM			
3.2 FSI 4motion	184	11/05 → 11/10				FCP1636	LUCAS/TRW	For PR code:2EA
3.6 FSI	206	09/05 → 11/10	FCP4223	ATE				
3.6 FSI	206	09/05 → 11/10	FCP1765	ATE				
3.6 FSI	206	09/05 → 11/10				FCP1636	LUCAS/TRW	
3.6 FSI 4motion	206	09/05 → 11/10	FCP4223	ATE				
3.6 FSI 4motion	206	09/05 → 11/10	FCP1765	ATE				
3.6 FSI 4motion	206	09/05 → 11/10				FCP1636	LUCAS/TRW	
3.6 R36 4motion	220	04/07 → 11/10	FCP4223	ATE				
3.6 R36 4motion	220	04/07 → 11/10	FCP1765	ATE	For PR code:1LK/1LM			
3.6 R36 4motion	220	04/07 → 11/10				FCP1636	LUCAS/TRW	For PR code:2EL

PASSAT Variant (3G5)

1.4 GTE Hybrid	115	11/14 →	FCP4425	LUCAS/TRW	Pr Number 1LA			
1.4 GTE Hybrid	115	11/14 →	FCP4433	LUCAS/TRW	Pr Number 1ZA			
1.4 GTE Hybrid	115	11/14 →				FCP4697	ATE	For PR code:1KU/1KZ
1.4 TSI	110	11/14 →	FCP4433	LUCAS/TRW				
1.4 TSI	110	11/14 →				FCP4697	ATE	For PR code:1KU/1KZ
1.4 TSI	92	11/14 →	FCP4433	LUCAS/TRW				
1.4 TSI	92	11/14 →				FCP4697	ATE	For PR code:1KU/1KZ
1.4 TSI 4motion	110	02/15 →	FCP4425	LUCAS/TRW	Pr Number 1LA			
1.4 TSI 4motion	110	02/15 →	FCP4433	LUCAS/TRW	Pr Number 1ZA			
1.4 TSI 4motion	110	02/15 →				FCP4697	ATE	For PR code:1KU/1KZ
1.6 TDI	88	08/14 →	FCP4433	LUCAS/TRW				
1.6 TDI	88	08/14 →				FCP4697	ATE	For PR code:1KU/1KZ
1.8 TSI	132	02/15 →	FCP4425	LUCAS/TRW	Pr Number 1LA			
1.8 TSI	132	02/15 →	FCP4433	LUCAS/TRW	Pr Number 1ZA			
1.8 TSI	132	02/15 →				FCP4697	ATE	For PR code:1KU/1KZ
2.0 TDI	110	11/14 →	FCP4433	LUCAS/TRW				
2.0 TDI	110	11/14 →				FCP4697	ATE	For PR code:1KU/1KZ
2.0 TDI	140	11/14 →	FCP4433	LUCAS/TRW				
2.0 TDI	140	11/14 →				FCP4697	ATE	For PR code:1KU/1KZ
2.0 TDI 4motion	110	02/15 →	FCP4425	LUCAS/TRW	Pr Number 1LA			
2.0 TDI 4motion	110	02/15 →	FCP4433	LUCAS/TRW	Pr Number 1ZA			
2.0 TDI 4motion	110	02/15 →				FCP4697	ATE	For PR code:1KU/1KZ
2.0 TDI 4motion	140	11/14 →	FCP4425	LUCAS/TRW	Pr Number 1LA			
2.0 TDI 4motion	140	11/14 →	FCP4433	LUCAS/TRW	Pr Number 1ZA			
2.0 TDI 4motion	140	11/14 →				FCP4697	ATE	For PR code:1KU/1KZ
2.0 TDI 4motion	176	08/14 →	FCP4433	LUCAS/TRW				
2.0 TDI 4motion	176	08/14 →				FCP4697	ATE	For PR code:1KU/1KZ
2.0 TSI	162	02/15 →	FCP4425	LUCAS/TRW	Pr Number 1LA			
2.0 TSI	162	02/15 →	FCP4433	LUCAS/TRW	Pr Number 1ZA			
2.0 TSI	162	02/15 →				FCP4697	ATE	For PR code:1KU/1KZ
2.0 TSI 4motion	206	05/15 →	FCP4425	LUCAS/TRW	Pr Number 1LA			
2.0 TSI 4motion	206	05/15 →	FCP4433	LUCAS/TRW	Pr Number 1ZA,1ZC			
2.0 TSI 4motion	206	05/15 →				FCP4697	ATE	For PR code:1KU/1KZ/2EA

For material availability see page 16-18 / Per la disponibilità materiali vedere a pagina 16-18

1248

FERODO

RACING

Updated on 17th Aug 2018

VOLKSWAGEN



KW



...VOLKSWAGEN

PHAETON (3D_)

6.0 W12 4motion	309	04/02 →	FCP1664	BREMBO	18 inch wheel				
-----------------	-----	---------	---------	--------	---------------	--	--	--	--

Polo

0.9		01/85 → 12/90	FCP385	KELGATE					
0.9	25, 29	01/75 → 12/84	FCP105	ATE					
1.0	29	08/78 → 12/84	FCP105	ATE					
1.0	29, 33	01/85 → 12/86	FCP385	KELGATE					
1.0	29, 33	01/85 → 12/86	FCP419	KELGATE					
1.0	29, 33	01/87 → 08/90	FCP392	KELGATE					
1.0	33, 37	06/95 →	FCP1101	ATE					
1.1	37, 44	01/75 → 12/84	FCP105	ATE					
1.3	40, 56	09/90 → 09/94	FCP385	KELGATE					
1.3	40, 56	09/90 → 09/94	FCP1101	ATE					
1.3	40, 56	10/94 → 06/95	FCP385	KELGATE					
1.3	40, 56	10/94 → 06/95	FCP1101	ATE					
1.3	40, 56	06/95 →	FCP1101	ATE					
1.3	43, 44	01/75 → 12/78	FCP105	ATE					
1.3	44	08/78 → 12/84	FCP105	ATE					
1.3	55	08/78 → 12/84	FCP105	ATE					
1.3 G40	85	05/91 → 09/94	FCP392	KELGATE					
1.3 G40	85	05/91 → 09/94				FCP541	LUCAS/TRW		
1.3 GT	40, 56	01/90 → 08/94	FCP419	KELGATE					
1.3 GT	40, 56	01/90 → 08/94				FCP541	LUCAS/TRW		
1.4 Classic	44	06/95 → 12/97	FCP1101	ATE					
1.4 Variant	44	01/97 →	FCP1101	ATE					
1.6 Hatchback		06/95 →	FCP1101	ATE					
1.6 Saloon	55, 74	06/95 → 12/97	FCP1101	ATE					
1.6 Saloon	55, 74	01/97 →	FCP1101	ATE					
1.6 Saloon	55, 74	01/97 →	FCP1312	LUCAS/TRW					
1.7 SDi	42	06/95 →	FCP1101	ATE					
1.9 D Saloon	47	11/95 →	FCP1101	ATE	Solid				
1.9 TDi Saloon	66	01/97 →	FCP1312	LUCAS/TRW					
1.9 TDi Saloon	66	01/97 →				FCP1312	LUCAS/TRW		

Polo (6R_)

1.2	44	06/09 →	FCP1641	ATE	PR: 1LN,1ZC,1ZD				
1.2	44	06/09 →	FCP1094	ATE	PR: 1ZG,1LR,1ZJ				
1.2	44	06/09 →				FCP1491	LUCAS/TRW	PR: 1KK,1KT,1KV,2EJ	
1.2	51	06/09 →	FCP1641	ATE	PR: 1LN,1ZC,1ZD				
1.2	51	06/09 →	FCP1094	ATE	PR: 1ZG,1LR,1ZJ				
1.2	51	06/09 →				FCP1491	LUCAS/TRW	PR: 1KK,1KT,1KV,2EJ	
1.2 TDI	55	10/09 →	FCP1641	ATE	PR: 1LN,1ZC,1ZD				
1.2 TDI	55	10/09 →	FCP1094	ATE	PR: 1ZG,1LR,1ZJ				
1.2 TDI	55	10/09 →				FCP1491	LUCAS/TRW	PR: 1KK,1KT,1KV,2EJ	
1.2 TSI	66	05/11 →	FCP1641	ATE	PR: 1LN,1ZC,1ZD				
1.2 TSI	66	05/11 →	FCP1094	ATE	PR: 1ZG,1LR,1ZJ				
1.2 TSI	66	05/11 →				FCP1491	LUCAS/TRW	PR: 1KK,1KT,1KV,2EJ	
1.2 TSI	77	11/09 →	FCP1641	ATE	PR: 1LN,1ZC,1ZD				
1.2 TSI	77	11/09 →	FCP1094	ATE	PR: 1ZG,1LR,1ZJ				
1.2 TSI	77	11/09 →				FCP1491	LUCAS/TRW	PR: 1KK,1KT,1KV,2EJ	
1.4	63	06/09 →	FCP1641	ATE	PR: 1LN,1ZC,1ZD				
1.4	63	06/09 →	FCP1094	ATE	PR: 1ZG,1LR,1ZJ				
1.4	63	06/09 →				FCP1491	LUCAS/TRW	PR: 1KK,1KT,1KV,2EJ	
1.4 BiFuel	60	03/10 → 01/11	FCP1641	ATE	PR: 1LN,1ZC,1ZD				
1.4 BiFuel	60	03/10 → 01/11	FCP1094	ATE	PR: 1ZG,1LR,1ZJ				
1.4 BiFuel	60	03/10 → 01/11				FCP1491	LUCAS/TRW	PR: 1KK,1KT,1KV,2EJ	
1.4 TSI	103	10/12 →	FCP1641	ATE	PR: 1LN,1ZC,1ZD				
1.4 TSI	103	10/12 →	FCP1094	ATE	PR: 1ZG,1LR,1ZJ				
1.4 TSI	103	10/12 →				FCP1491	LUCAS/TRW	PR: 1KK,1KT,1KV,2EJ	
1.6 BiFuel	60	01/11 →	FCP1641	ATE	PR: 1LN,1ZC,1ZD				
1.6 BiFuel	60	01/11 →	FCP1094	ATE	PR: 1ZG,1LR,1ZJ				
1.6 BiFuel	60	01/11 →				FCP1491	LUCAS/TRW	PR: 1KK,1KT,1KV,2EJ	
1.6 TDI	55	06/09 →	FCP1641	ATE	PR: 1LN,1ZC,1ZD				
1.6 TDI	55	06/09 →	FCP1094	ATE	PR: 1ZG,1LR,1ZJ				
1.6 TDI	55	06/09 →				FCP1491	LUCAS/TRW	PR: 1KK,1KT,1KV,2EJ	
1.6 TDI	66	06/09 →	FCP1641	ATE	PR: 1LN,1ZC,1ZD				
1.6 TDI	66	06/09 →	FCP1094	ATE	PR: 1ZG,1LR,1ZJ				
1.6 TDI	66	06/09 →				FCP1491	LUCAS/TRW	PR: 1KK,1KT,1KV,2EJ	
1.6 TDI	77	06/09 →	FCP1641	ATE	PR: 1LN,1ZC,1ZD				
1.6 TDI	77	06/09 →	FCP1094	ATE	PR: 1ZG,1LR,1ZJ				
1.6 TDI	77	06/09 →				FCP1491	LUCAS/TRW	PR: 1KK,1KT,1KV,2EJ	
2.0 R WRC	162	08/13 →	FCP1641	ATE	PR: 1LN,1ZC,1ZD				
2.0 R WRC	162	08/13 →	FCP1094	ATE	PR: 1ZG,1LR,1ZJ				
2.0 R WRC	162	08/13 →				FCP1491	LUCAS/TRW	PR: 1KK,1KT,1KV,2EJ	

VOLKSWAGEN

For material availability see page 16-18 / Per la disponibilità materiali vedere a pagina 16-18



KW



...VOLKSWAGEN

NOTE

NOTE

POLO (86C, 80)

1.3 Cat	55	10/89 → 03/91	FCP419	KELGATE		
1.3 Cat	55	10/89 → 03/91	FCP385	KELGATE		

Polo (9N_)

1.4 16V	55	10/01 → 05/08	FCP1419	LUCAS/TRW		
1.4 16V	74	10/01 → 05/08	FCP1419	LUCAS/TRW		
1.8 GTI	110	09/05 → 11/09	FCP1419	LUCAS/TRW	PR 1LN, 1ZD(+9U0),1ZH	
1.8 GTI Cup Edition	132	05/06 → 11/09	FCP1419	LUCAS/TRW	PR 1LN, 1ZD(+9U0),1ZH	

Polo (I)

0.9	25, 29	08/78 → 09/81	FCP105	ATE		
0.9	25, 29	10/81 → 12/84	FCP105	ATE		
0.9 i		01/85 → 12/90	FCP385	KELGATE		
0.9 i	25, 29	01/75 → 07/78	FCP105	ATE		
1.0	29	08/78 → 12/84	FCP105	ATE		
1.0	29, 33	01/85 → 12/86	FCP385	KELGATE		
1.0	29, 33	01/85 → 12/86	FCP419	KELGATE		
1.0 i	29, 33	01/87 → 08/90	FCP392	KELGATE		
1.1	37, 44	08/78 → 09/81	FCP105	ATE		
1.1	37, 44	10/81 → 12/84	FCP105	ATE		
1.1 i	37, 44	01/75 → 07/78	FCP105	ATE		
1.3	43	08/78 → 12/84	FCP105	ATE		
1.3	44	08/78 → 12/84	FCP105	ATE		
1.3	55	08/78 → 12/84	FCP105	ATE		
1.3 i	40, 55	01/87 → 08/90	FCP392	KELGATE		
1.3 i	40, 56	09/90 → 09/94	FCP385	KELGATE		
1.3 i	40, 56	09/90 → 09/94	FCP1101	ATE		
1.3 i	43, 44	01/75 → 12/78	FCP105	ATE		

Polo (II)

1.0 i	33, 37	06/95 → 09/01	FCP1101	ATE		
1.3 i	40, 56	10/94 → 06/95	FCP1101	ATE		
1.4 i	40, 44	06/95 → 09/01	FCP1101	ATE		
1.4 i 16V	55	10/99 → 09/01	FCP1101	ATE		
1.4 i 16V	55	10/99 → 09/01	FCP1312	LUCAS/TRW		
1.6 i	55	10/94 → 10/99	FCP1101	ATE		
1.6 i GTi 16V	74	09/98 → 09/01	FCP1312	LUCAS/TRW		
1.7 SDi	42	04/97 → 09/01	FCP1101	ATE		
1.9 D, SDi	47	10/94 → 09/01	FCP1101	ATE		

Polo (II) Classic

1.4 i	44	12/95 → 12/97	FCP1054	ATE		
1.4 i	44	12/95 → 12/97	FCP1288	ATE		
1.4 i	44, 55	12/97 → 09/01	FCP1288	ATE		
1.6 i	55	11/96 → 09/01	FCP774	LUCAS/TRW		
1.6 i	55	11/96 → 09/01	FCP1312	LUCAS/TRW		
1.6 i	74	11/96 → 09/01	FCP774	LUCAS/TRW		
1.6 i	74	11/96 → 09/01	FCP1312	LUCAS/TRW		
1.7 SDi	42	07/97 → 09/01	FCP1054	ATE		
1.7 SDi	42	07/97 → 09/01	FCP1288	ATE		
1.9 SDi	47, 50	12/95 → 09/01	FCP1054	ATE		
1.9 SDi	47, 50	12/95 → 09/01	FCP1288	ATE		
1.9 TDi	66, 81	09/96 → 09/01	FCP1312	LUCAS/TRW		

Polo (II) Variant

1.4 i	40	05/97 → 12/97	FCP1054	ATE		
1.4 i	40	12/97 → 09/01	FCP1288	ATE		
1.4 i	44	05/97 → 12/97	FCP1054	ATE		
1.4 i	44	12/97 → 09/01	FCP1288	ATE		
1.4 i	55	05/97 → 12/97	FCP1054	ATE		
1.4 i	55	12/97 → 09/01	FCP1288	ATE		
1.6 i	55, 74	05/97 → 09/01	FCP774	LUCAS/TRW		
1.6 i	55, 74	05/97 → 09/01	FCP1312	LUCAS/TRW		
1.7 SDi	42	08/97 → 09/01	FCP1054	ATE		
1.7 SDi	42	08/97 → 09/01	FCP1288	ATE		
1.9 SDi	47, 50	06/97 → 09/01	FCP1054	ATE		
1.9 SDi	47, 50	06/97 → 09/01	FCP1288	ATE		
1.9 TDi	66, 81	05/97 → 09/01	FCP1312	LUCAS/TRW		

Polo (III)

1.2 i	40	10/01 →	FCP1419	LUCAS/TRW		
1.2 i	40	10/01 →			FCP1491	LUCAS/TRW
1.2 i	47	10/01 →	FCP1419	LUCAS/TRW		
1.2 i	47	10/01 →			FCP1491	LUCAS/TRW
1.4 FSi	63	05/02 →	FCP1419	LUCAS/TRW		
1.4 FSi	63	05/02 →			FCP1491	LUCAS/TRW

For material availability see page 16-18 / Per la disponibilità materiali vedere a pagina 16-18

1250

FERODO

RACING

Updated on 17th Aug 2018

VOLKSWAGEN



KW



...VOLKSWAGEN

...Polo (III)

1.4 TDi	55	10/99 →	FCP1419	LUCAS/TRW			
1.4 TDi	55	10/01 →	FCP1419	LUCAS/TRW			
1.9 SDi	47	10/01 →	FCP1419	LUCAS/TRW			
1.9 TDi	74	10/01 →	FCP1419	LUCAS/TRW			

POLO CLASSIC (86C, 80)

1.3	40	01/85 → 07/87	FCP419	KELGATE			
1.3	40	01/85 → 07/87	FCP385	KELGATE			

POLO Coupe (86C, 80)

1.3 G40	85	01/87 → 08/90	FCP419	KELGATE			
1.3 G40	85	01/87 → 08/90	FCP385	KELGATE			

Polo Van

1.0	33	01/86 → 07/95	FCP385	KELGATE			
1.3		01/86 → 07/95	FCP385	KELGATE			
1.4	35	01/86 → 07/95	FCP385	KELGATE			
1.4 60	35	07/95 →	FCP385	KELGATE			
1.6	55	01/86 → 07/95	FCP385	KELGATE			
1.6 64, 75, 100	55	07/95 →	FCP419	KELGATE			
1.9	47	01/86 → 07/95	FCP385	KELGATE			
1.9 64, 75, 100	47	07/95 →	FCP419	KELGATE			

Santana

1.3	40	08/81 → 11/81	FCP105	ATE			
1.3	40	12/81 → 07/83	FCP419	KELGATE			
1.6 Auto	55	01/82 → 12/83	FCP419	KELGATE			
1.6 CX	55	01/84 → 01/85	FCP419	KELGATE			
1.6 D	40	08/81 → 12/84	FCP419	KELGATE			
1.6 Man	63	01/82 → 12/83	FCP419	KELGATE			
1.6 TD	40, 51	12/81 → 12/84	FCP419	KELGATE			
1.8	66	01/82 → 12/83	FCP419	KELGATE			
1.8 LX	66, 68	01/84 → 01/85	FCP419	KELGATE			
1.9	85	08/82 → 03/85	FCP419	KELGATE			
2.0	85	08/83 → 03/86	FCP419	KELGATE			
2.0	85	08/84 → 03/86	FCP392	KELGATE			

Scirocco

1.1	37, 38	01/74 → 07/80	FCP105	ATE			
1.3	40, 44	01/81 → 01/84	FCP419	KELGATE			
1.3	40, 44	08/83 → 01/84	FCP419	KELGATE			
1.3	44	01/76 → 12/81	FCP105	ATE			
1.5	51	01/74 → 07/80	FCP105	ATE			
1.5	51	08/80 → 01/84	FCP419	KELGATE			
1.5	55	01/74 → 12/78	FCP105	ATE			
1.5	63	01/74 → 12/78	FCP105	ATE			
1.6	51, 55	01/84 → 08/88	FCP392	KELGATE			
1.6	55	08/80 → 12/83	FCP419	KELGATE			
1.6	63	08/80 → 12/83	FCP419	KELGATE			
1.6	81	08/80 → 12/83	FCP419	KELGATE			
1.6 GLi	81	01/74 → 07/80	FCP105	ATE			
1.6 GLi	81	08/80 → 12/83	FCP419	KELGATE			
1.6 GTi		08/79 → 12/83	FCP392	KELGATE			
1.6 GTi	81	01/76 → 07/79	FCP105	ATE			
1.8	66	01/84 → 08/89	FCP775	LUCAS/TRW			
1.8	66	01/84 → 08/89	FCP392	KELGATE			
1.8	70	01/84 → 08/89	FCP775	LUCAS/TRW			
1.8	70	01/84 → 08/89	FCP392	KELGATE			
1.8	82	01/84 → 08/89	FCP775	LUCAS/TRW			
1.8	82	01/84 → 08/89	FCP392	KELGATE			
1.8 GL, GTi	66, 82	08/83 → 12/83	FCP392	KELGATE			
1.8 GT2	66, 70	08/89 → 10/91	FCP774	LUCAS/TRW			
1.8 i 16V	102	01/84 → 08/89	FCP774	LUCAS/TRW			
1.8 i 16V	102	01/84 → 08/89			FCP541	LUCAS/TRW	
1.8 i Scala 16V	95, 102	09/89 → 10/91	FCP775	LUCAS/TRW			
1.8 i Scala 16V	95, 102	09/89 → 10/91	FCP774	LUCAS/TRW			
1.8 i Scala 16V	95, 102	09/89 → 10/91	FCP392	KELGATE			
1.8 i Scala 16V	95, 102	09/89 → 10/91			FCP541	LUCAS/TRW	

SCIROCCO (137, 138)

1.4 TSI	118	05/08 →	FCP4223	ATE	PR 1ZK (345mm disc)		
1.4 TSI	118	05/08 →	FCP1641	ATE	PR 1LJ,1ZD,1ZE,1ZP (312&288mm disc)		
1.4 TSI	118	05/08 →				FCP1491	LUCAS/TRW 255 mm disc
1.4 TSI	118	05/08 →				FCP4316	BOSCH PR 1KS (272mm disc)
1.4 TSI	118	05/08 →				FCP1636	LUCAS/TRW PR 1KE,1KW,1KZ (310mm disc)
1.4 TSI	90	08/08 →	FCP4223	ATE	PR 1ZK (345mm disc)		

VOLKSWAGEN

For material availability see page 16-18 / Per la disponibilità materiali vedere a pagina 16-18



RACING

Updated on 17th Aug 2018

1251



KW



...VOLKSWAGEN

...SCIROCCO (137, 138)

			NOTE			NOTE		
1.4 TSI	90	08/08 →	FCP1641	ATE	PR 1LJ,1ZD,1ZE,1ZP (312&288mm disc)	FCP1636	LUCAS/TRW	PR 1KE,1KW,1KZ (310mm disc)
1.4 TSI	90	08/08 →				FCP4316	BOSCH	PR 1KS (272mm disc)
1.4 TSI	90	08/08 →				FCP1491	LUCAS/TRW	255 mm disc
1.4 TSI	150	07/15 →	FCP4223	ATE	PR 1ZK (345mm disc)			
1.4 TSI	92	11/13 →	FCP1641	ATE	312&288			
2.0 R	188	11/09 → 11/17	FCP1641	ATE	PR 1LJ,1ZD,1ZE,1ZP (312&288mm disc)			
2.0 R	188	11/09 → 11/17	FCP4223	ATE	For PR code:1ZK			
2.0 R	188	11/09 → 11/17				FCP1636	LUCAS/TRW	For PR code:1KW
2.0 R	188	11/09 → 11/17				FCP4316	BOSCH	PR 1KS (272mm disc)
2.0 R	195	11/09 → 11/17	FCP1641	ATE	PR 1LJ,1ZD,1ZE,1ZP (312&288mm disc)			
2.0 R	195	11/09 → 11/17	FCP4223	ATE	For PR code:1ZK			
2.0 R	195	11/09 → 11/17				FCP1491	LUCAS/TRW	PR 1KD (255mm disc)
2.0 R	195	11/09 → 11/17				FCP1636	LUCAS/TRW	For PR code:1KW
2.0 R	195	11/09 → 11/17				FCP4316	BOSCH	PR 1KS (272mm disc)
2.0 R	206	05/14 → 11/17	FCP4223	ATE	For PR code:1ZK			
2.0 R	206	05/14 → 11/17	FCP1641	ATE	312&288 mm disc			
2.0 R	206	05/14 → 11/17				FCP1636	LUCAS/TRW	For PR code:1KW
2.0 TDI	100	11/10 →	FCP1641	ATE	PR 1ZE (312&288mm disc)			
2.0 TDI	100	11/10 →				FCP1636	LUCAS/TRW	310 mm disc
2.0 TDI	100	11/10 →				FCP1491	LUCAS/TRW	255 mm disc
2.0 TDI	100	11/10 →				FCP4316	BOSCH	272 mm disc
2.0 TDI	103	08/08 →	FCP4223	ATE	PR 1ZK (345mm disc)			
2.0 TDI	103	08/08 →	FCP1641	ATE	PR 1LJ,1ZD,1ZE,1ZP (312&288mm disc)			
2.0 TDI	103	08/08 →				FCP1636	LUCAS/TRW	PR 1KE,1KW,1KZ (310mm disc)
2.0 TDI	103	08/08 →				FCP1491	LUCAS/TRW	255 mm disc
2.0 TDI	103	08/08 →				FCP4316	BOSCH	PR 1KS (272mm disc)
2.0 TDI	110	11/13 → 11/17	FCP4223	ATE	Disc Diam mm:345,For PR code:1ZK			
2.0 TDI	110	11/13 → 11/17	FCP1641	ATE	Disc Diam mm:288,For PR code:1ZE			
2.0 TDI	110	11/13 → 11/17				FCP1636	LUCAS/TRW	310 mm disc
2.0 TDI	110	11/13 → 11/17				FCP1491	LUCAS/TRW	
2.0 TDI	125	05/09 →	FCP1641	ATE	PR 1LJ,1ZD,1ZE,1ZP(312&288mm disc)			
2.0 TDI	125	05/09 →	FCP4223	ATE	PR 1ZK (345mm disc)			
2.0 TDI	125	05/09 →				FCP1491	LUCAS/TRW	PR 1KD (255mm disc)
2.0 TDI	125	05/09 →				FCP1636	LUCAS/TRW	PR 1KE,1KW,1KZ (310mm disc)
2.0 TDI	125	05/09 →				FCP4316	BOSCH	PR 1KS (272mm disc)
2.0 TDI	130	01/13 →	FCP1641	ATE	312&288 mm disc			
2.0 TDI	130	01/13 →				FCP1636	LUCAS/TRW	310 mm disc
2.0 TDI	130	01/13 →				FCP1491	LUCAS/TRW	255 mm disc
2.0 TDI	130	01/13 →				FCP4316	BOSCH	272 mm disc
2.0 TDI	135	05/14 → 11/17	FCP4223	ATE	For PR code:1ZK			
2.0 TDI	135	05/14 → 11/17	FCP1641	ATE	For PR code:1ZE			
2.0 TDI	135	05/14 → 11/17				FCP1636	LUCAS/TRW	PR 1KW (310mm disc)
2.0 TDI	135	05/14 → 11/17				FCP1491	LUCAS/TRW	
2.0 TDI	135	05/14 → 11/17				FCP4316	BOSCH	PR 1KS,1KT (272mm disc)
2.0 TSI	132	11/13 → 11/17	FCP4223	ATE	Disc Diam mm:345,For PR code:1ZK			
2.0 TSI	132	11/13 → 11/17	FCP1641	ATE	Disc Diam mm:288,For PR code:1ZE			
2.0 TSI	132	11/13 → 11/17				FCP1636	LUCAS/TRW	310 mm disc
2.0 TSI	132	11/13 → 11/17				FCP1491	LUCAS/TRW	
2.0 TSI	147	05/08 → 11/09	FCP4223	ATE	PR 1ZK (345mm disc)			
2.0 TSI	147	05/08 → 11/09	FCP1641	ATE	Disc Diam mm:312,For PR code:1LJ/1ZA/1ZB			
2.0 TSI	147	05/08 → 11/09				FCP1636	LUCAS/TRW	PR 1KE,1KW,1KZ (310mm disc)
2.0 TSI	147	05/08 → 11/09				FCP1491	LUCAS/TRW	255 mm disc
2.0 TSI	147	05/08 → 11/09				FCP4316	BOSCH	PR 1KS (272mm disc)
2.0 TSI	155	11/09 → 05/11	FCP4223	ATE	PR 1ZK (345mm disc)			
2.0 TSI	155	11/09 → 05/11	FCP1641	ATE	PR 1LJ,1ZD,1ZE,1ZP (312&288mm disc)			
2.0 TSI	155	11/09 → 05/11				FCP1636	LUCAS/TRW	PR 1KE,1KW,1KZ (310mm disc)
2.0 TSI	155	11/09 → 05/11				FCP1491	LUCAS/TRW	255 mm disc
2.0 TSI	155	11/09 → 05/11				FCP4316	BOSCH	PR 1KS (272mm disc)
2.0 TSI	162	11/13 → 11/17	FCP4223	ATE	For PR code:1ZK			
2.0 TSI	162	11/13 → 11/17	FCP1641	ATE	For PR code:1ZE			
2.0 TSI	162	11/13 → 11/17				FCP1636	LUCAS/TRW	310 mm disc
2.0 TSI	162	11/13 → 11/17				FCP4316	BOSCH	For PR code:1KS/1KT

SCIROCCO (53)

1.6	51	08/75 → 07/77	FCP105	ATE				
1.6	55	08/75 → 07/79	FCP105	ATE				
1.6	63	08/75 → 07/80	FCP105	ATE				
1.6	81	06/76 → 07/80	FCP105	ATE				

SHARAN

1.8 20V	110	01/95 → 04/98	FCP590	ATE				
1.8 20V	110	01/95 → 04/98				FCP541	LUCAS/TRW	
1.9 TDi	66, 81	01/95 → 04/00	FCP590	ATE				
1.9 TDi	66, 81	01/95 → 04/00				FCP541	LUCAS/TRW	
2.0	85	01/95 → 04/00	FCP590	ATE				
2.0	85	01/95 → 04/00				FCP541	LUCAS/TRW	

For material availability see page 16-18 / Per la disponibilità materiali vedere a pagina 16-18

1252

FERODO

RACING

Updated on 17th Aug 2018

VOLKSWAGEN



KW

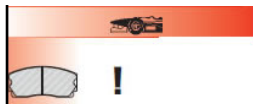

...VOLKSWAGEN

...SHARAN

2.0 16V	110	08/96 → 04/00	FCP590	ATE				
2.0 16V	110	08/96 → 04/00				FCP541	LUCAS/TRW	
2.8	128	01/95 → 04/00	FCP590	ATE				
2.8	128	01/95 → 04/00				FCP541	LUCAS/TRW	

SHARAN (7N1, 7N2)

1.4 TSI	110	05/10 →	FCP4425	LUCAS/TRW	PR 1LX,1LW(314mm disc)			
1.4 TSI	110	05/10 →				FCP1636	LUCAS/TRW	
2.0 TDI	100	05/10 →	FCP4425	LUCAS/TRW	PR 1LX,1LW(314mm disc)			
2.0 TDI	100	05/10 →				FCP1636	LUCAS/TRW	
2.0 TDI	103	05/10 →	FCP4425	LUCAS/TRW	PR 1LX,1LW(314mm disc)			
2.0 TDI	103	05/10 →				FCP1636	LUCAS/TRW	
2.0 TDI	125	08/10 →	FCP4425	LUCAS/TRW	PR 1LX,1LW(314mm disc)			
2.0 TDI	125	08/10 →				FCP1636	LUCAS/TRW	
2.0 TDI	85	05/11 →	FCP4425	LUCAS/TRW	PR 1LX,1LW(314mm disc)			
2.0 TDI	85	05/11 →				FCP1636	LUCAS/TRW	
2.0 TDI 4motion	100	05/11 → 05/12	FCP4425	LUCAS/TRW	PR 1LX,1LW(314mm disc)			
2.0 TDI 4motion	100	05/11 → 05/12				FCP1636	LUCAS/TRW	
2.0 TDI 4motion	103	05/11 →	FCP4425	LUCAS/TRW	PR 1LX,1LW(314mm disc)			
2.0 TDI 4motion	103	05/11 →				FCP1636	LUCAS/TRW	
2.0 TSI	147	12/10 →	FCP4425	LUCAS/TRW	PR 1LX,1LW(314mm disc)			
2.0 TSI	147	12/10 →				FCP1636	LUCAS/TRW	

Touareg (7LA/7L6/7L7)

2.5 R5 TDI	120	08/03 → 05/10	FCP4064	BREMBO	PR 1LU/1LT			
2.5 R5 TDi	128	01/03 →	FCP1625	BREMBO	17"			
2.5 R5 TDi	128	01/03 → 05/10	FCP4064	BREMBO	PR 1LU/1LT			
2.5 R5 TDi	128	01/03 →				FCP1308	BREMBO	17" / 18"
3.0 TDI	155	04/06 → 05/10	FCP4064	BREMBO	PR 1LU/1LT			
3.0 V6 TDI	176	11/07 → 05/10	FCP4064	BREMBO	PR 1LU/1LT			
3.0 V6 TDi	165	11/04 →	FCP1625	BREMBO	17"			
3.0 V6 TDi	165	11/04 →	FCP1334	BREMBO				
3.0 V6 TDi	165	11/04 → 05/10	FCP4064	BREMBO	PR 1LU/1LT			
3.0 V6 TDi	165	11/04 →				FCP1308	BREMBO	17" / 18"
3.2 V6	177	10/02 → 11/06	FCP1625	BREMBO	17"			
3.2 V6	177	10/02 → 11/06				FCP1308	BREMBO	17" / 18"
3.2 V6	177	11/04 → 11/06	FCP4064	BREMBO	PR 1LU/1LT			
3.2 V6	177	11/04 → 11/06	FCP1334	BREMBO	PR 1LE, Rim size 17 inch			
3.2 V6	162	10/02 → 11/06	FCP1625	BREMBO	17"			
3.2 V6	162	10/02 → 11/06	FCP1334	BREMBO	PR 1LE, Rim size 17 inch			
3.2 V6	162	10/02 → 11/06	FCP4064	BREMBO	PR 1LU/1LT			
3.2 V6	162	10/02 → 11/06				FCP1308	BREMBO	17" / 18"
3.6 V6 FSI	206	10/05 → 05/10	FCP4064	BREMBO	PR 1LU/1LT			
3.6 V6 FSI	206	03/06 →	FCP1334	BREMBO				
3.6 V6 FSI	206	03/06 →				FCP1308	BREMBO	17" / 18"
4.2 V8	228	12/02 →	FCP1626	BREMBO				
4.2 V8	228	12/02 → 11/06	FCP4064	BREMBO	PR 1LU/1LT			
4.2 V8	228	12/02 →				FCP1308	BREMBO	17" / 18"
4.2 V8 FSI	257	06/06 → 05/10	FCP4064	BREMBO	PR 1LU/1LT			
5.0 R50 TDI	257	08/07 → 05/10	FCP4064	BREMBO	PR 1LU/1LT			
5.0 V10 TDI	230	10/02 →	FCP1626	BREMBO				
5.0 V10 TDI	230	10/02 → 05/10	FCP4064	BREMBO	PR 1LU/1LT			
5.0 V10 TDI	230	10/02 →				FCP1308	BREMBO	17" / 18"
6.0 V12	331	08/04 → 05/10	FCP4064	BREMBO	PR 1LU/1LT			
6.0 V12	331	03/05 →	FCP1626	BREMBO				
6.0 V12	331	03/05 →				FCP1308	BREMBO	17" / 18"

Touran

1.4 TSi 16v (1T1/1T2, 1T3)	103	02/06 →	FCP1641	ATE	PR 1ZP, 1ZE, 1ZA, 1ZD/1ZP			
1.4 TSi 16v (1T1/1T2, 1T3)	103	02/06 →				FCP4316	BOSCH	
1.4 TSi 16v (1T3)	125	05/10 →	FCP1641	ATE	PR 1ZE, 1ZA, 1ZD/1ZP			
1.4 TSi 16v (1T3)	125	05/10 →				FCP4316	BOSCH	
1.6 FSi	85	02/03 →	FCP1641	ATE				
1.6 FSi	85	02/03 →				FCP1636	LUCAS/TRW	
1.6 i	75	02/03 →	FCP1641	ATE				
1.6 i	75	02/03 →				FCP1636	LUCAS/TRW	
1.9 TDi	74	02/03 →	FCP1641	ATE				
1.9 TDi	74	02/03 →				FCP1636	LUCAS/TRW	
2.0 TDi	125	12/05 →	FCP1641	ATE				
2.0 TDi	125	12/05 →				FCP1636	LUCAS/TRW	
2.0 TDi 16v (1T1/1T2)	100	02/03 → 05/10	FCP1641	ATE	PR 1ZP, 1ZE			
2.0 TDi 16v (1T1/1T2)	100	02/03 → 05/10				FCP4316	BOSCH	
2.0 TDi 16v (1T1/1T2,1T3)	103	08/03 →	FCP1641	ATE	PR 1ZP, 1ZE, 1ZA, 1ZD/1ZP			
2.0 TDi 16v (1T1/1T2,1T3)	103	08/03 →				FCP4316	BOSCH	
2.0 TDi 16v (1T3)	125	05/10 →	FCP1641	ATE	PR 1ZE, 1ZA, 1ZD/1ZP			
2.0 TDi 16v (1T3)	125	05/10 →				FCP4316	BOSCH	
2.0 TDi 16v (1T3)	81	05/10 →	FCP1641	ATE	PR 1ZE, 1ZA, 1ZD/1ZP			

For material availability see page 16-18 / Per la disponibilità materiali vedere a pagina 16-18



KW



...VOLKSWAGEN

...Touran

2.0 TDi 16v (1T3)	81	05/10	→
2.0 TDi 8v (1T1/1T2)	103	12/05	→ 05/10
2.0 TDi 8v (1T1/1T2)	103	12/05	→ 05/10

		NOTE			NOTE
FCP1641	ATE	PR 1ZP, 1ZE	FCP4316	BOSCH	
FCP4316			FCP4316	BOSCH	

TOURAN (5T1)

1.2 TSI	81	05/15	→
1.2 TSI	81	05/15	→
1.4 TSI	110	05/15	→
1.4 TSI	110	05/15	→
1.6 TDI	81	05/15	→ 05/16
1.6 TDI	81	05/15	→ 05/16
1.6 TDI	85	05/16	→
1.6 TDI	85	05/16	→
1.8 TSI	132	11/15	→
1.8 TSI	132	11/15	→
2.0 TDI	110	05/15	→
2.0 TDI	110	05/15	→
2.0 TDI	81	11/15	→
2.0 TDI	81	11/15	→

FCP4433	TRW	For PR code:1ZA			
FCP4433	ATE		FCP4434		For PR code:1KE
FCP4433	TRW	For PR code:1ZA			
FCP4433	ATE		FCP4434		For PR code:1KE
FCP4433	TRW	For PR code:1ZA			
FCP4433	ATE		FCP4434		For PR code:1KE
FCP4433	TRW	Disc Diam mm:312,For PR code:1ZA			
FCP4433	ATE		FCP4434		Disc Diam mm:272,For PR code:1KE
FCP4433	TRW	Disc Diam mm:312,For PR code:1ZA			
FCP4433	ATE		FCP4434		Disc Diam mm:272,For PR code:1KE
FCP4433	TRW	For PR code:1ZA			
FCP4433	ATE		FCP4434		For PR code:1KE
FCP4433	TRW				
FCP4433	ATE		FCP4434		

Vento

1.4	40, 44	07/95	→
1.4	44	11/91	→ 06/95
1.6	55	09/92	→ 12/96
1.6	55	09/92	→ 12/96
1.6	55	09/92	→ 12/96
1.6	74	09/92	→ 07/97
1.6	74	09/92	→ 07/97
1.6	74	09/92	→ 07/97
1.6 GT	74	10/94	→ 07/95
1.6 GT	74	10/94	→ 07/95
1.6 i	74	06/96	→ 07/97
1.6 i	74	06/96	→ 07/97
1.6 i	74	06/96	→ 07/97
1.8	55	01/92	→ 08/95
1.8	55	08/95	→ 04/96
1.8	66	01/92	→ 08/95
1.8	66	08/95	→ 07/97
1.8 GT	66	01/92	→ 07/95
1.8 GT	66	01/92	→ 07/95
1.8 i	66	05/96	→ 07/97
1.9 D	48, 55	08/95	→ 07/97
1.9 D	48	01/92	→ 08/95
1.9 D	55	01/92	→ 08/95
1.9 D	66	01/92	→ 08/95
1.9 TD	55	01/92	→ 12/94
1.9 TD	55	01/95	→ 07/97
1.9 TDi	66, 81	01/92	→ 07/97
1.9 TDi	66, 81	01/92	→ 07/97
1.9 TDi	66, 81	05/96	→ 07/97
1.9 TDi	66, 81	05/96	→ 07/97
2.0	85	01/92	→ 07/95
2.0	85	01/92	→ 07/95
2.0	85	01/92	→ 07/95
2.0 GT	85	01/92	→ 05/96
2.0 GT	85	01/92	→ 05/96
2.0 GT	85	05/96	→ 07/97
2.0 GT	85	05/96	→ 07/97
2.0 GT	85	05/96	→ 07/97
2.8 VR6	128	01/92	→ 02/95
2.8 VR6	128	01/92	→ 02/95
2.8 VR6	128	02/95	→ 07/97
2.8 VR6	128	02/95	→ 07/97
2.8 VR6	128	02/95	→ 07/97

FCP1054	ATE				
FCP419	KELGATE				
FCP419	KELGATE				
FCP775	LUCAS/TRW				
FCP1054	ATE				
FCP419	KELGATE				
FCP775	LUCAS/TRW				
FCP1054	ATE				
FCP774	LUCAS/TRW				
FCP419	KELGATE				
FCP775	LUCAS/TRW				
FCP1054	ATE				
FCP419	KELGATE				
FCP419	KELGATE				
FCP1054	ATE				
FCP774	LUCAS/TRW				
FCP541	LUCAS/TRW				
FCP1054	ATE				
FCP419	KELGATE				
FCP419	KELGATE				
FCP775	LUCAS/TRW				
FCP1054	ATE				
FCP775	LUCAS/TRW				
FCP541	LUCAS/TRW				
FCP774	LUCAS/TRW				
FCP541	LUCAS/TRW				
FCP774	LUCAS/TRW				
FCP775	LUCAS/TRW				
FCP541	LUCAS/TRW				
FCP775	LUCAS/TRW				
FCP541	LUCAS/TRW				
FCP590	ATE				
FCP775	LUCAS/TRW				
FCP775	LUCAS/TRW				
FCP541	LUCAS/TRW				
FCP775	LUCAS/TRW				
FCP541	LUCAS/TRW				
FCP775	LUCAS/TRW				
FCP541	LUCAS/TRW				

For material availability see page 16-18 / Per la disponibilità materiali vedere a pagina 16-18



KW



VOLVO				NOTE		NOTE
142						
2.0	80	01/68 → 01/75			FCP809	LUCAS/TRW
144						
2.0	80	01/68 → 01/75			FCP809	LUCAS/TRW
145						
2.0	80	01/68 → 01/75			FCP809	LUCAS/TRW
164						
3.0	85	01/68 → 01/75			FCP809	LUCAS/TRW
1800						
1.8 i ES		01/72 → 12/73			FCP809	LUCAS/TRW
1.8 S		01/69 → 12/70	FCP9	LUCAS/TRW		
221						
2.0	66	01/69 → 12/70	FCP9	LUCAS/TRW		
240						
		01/74 → 08/93			FCP809	LUCAS/TRW
All i		01/74 → 08/93			FCP2	ATE
All i		01/74 → 08/93			FCP809	LUCAS/TRW
242						
All i	60, 73	09/74 → 12/79			FCP2	ATE
All i	60, 73	09/74 → 12/79			FCP809	LUCAS/TRW
244						
		09/74 → 06/85			FCP809	LUCAS/TRW
All i		09/74 → 06/85			FCP2	ATE
All i		09/74 → 06/85			FCP809	LUCAS/TRW
245						
		09/74 → 06/85			FCP809	LUCAS/TRW
All i		09/74 → 06/85			FCP2	ATE
All i		09/74 → 06/85			FCP809	LUCAS/TRW
260 Estate (P265)						
2.7	103	07/75 → 07/82			FCP809	LUCAS/TRW
2.7	109	10/78 → 07/82			FCP809	LUCAS/TRW
2.7	92	08/75 → 07/77			FCP809	LUCAS/TRW
262						
2.7	92, 109	09/74 → 08/82			FCP809	LUCAS/TRW
2.8	114	09/74 → 08/82			FCP809	LUCAS/TRW
264						
2.4	60	09/74 → 08/82			FCP809	LUCAS/TRW
2.7	92, 106	09/74 → 08/82			FCP809	LUCAS/TRW
2.8	91, 114	09/74 → 08/82			FCP809	LUCAS/TRW
265						
2.8	91, 114	09/74 → 08/82			FCP809	LUCAS/TRW
340						
1.4	47	09/82 → 10/91	FCP370	LUCAS/TRW		
1.4	50	09/82 → 10/91	FCP370	LUCAS/TRW		
1.4	52	09/82 → 10/91	FCP370	LUCAS/TRW		
1.6 D	40	09/82 → 10/91	FCP370	LUCAS/TRW		
1.7	60	09/82 → 10/91	FCP370	LUCAS/TRW		
340-360 (343, 345)						
1.4	46	08/82 → 08/85	FCP370	LUCAS/TRW		
1.4	47	08/79 → 07/83	FCP370	LUCAS/TRW		
1.4	50	08/86 → 12/88	FCP370	LUCAS/TRW		
1.4	51	08/75 → 07/83	FCP370	LUCAS/TRW		
1.4	51	08/87 → 07/88	FCP370	LUCAS/TRW		
1.4	52	08/83 → 07/86	FCP370	LUCAS/TRW		
2.0	80	08/88 → 07/89	FCP370	LUCAS/TRW		
2.0	82	08/86 → 07/88	FCP370	LUCAS/TRW		
2.0	85	08/82 → 07/84	FCP370	LUCAS/TRW		

VOLVO

For material availability see page 16-18 / Per la disponibilità materiali vedere a pagina 16-18



KW



VOLVO

...VOLVO					NOTE			NOTE
340-360 Saloon (344)								
2.0	66	08/82 → 07/84	FCP370	LUCAS/TRW				
2.0	75	08/84 → 07/90	FCP370	LUCAS/TRW				
2.0	80	08/88 → 07/89	FCP370	LUCAS/TRW				
2.0	82	08/86 → 07/88	FCP370	LUCAS/TRW				
2.0	85	08/84 → 07/86	FCP370	LUCAS/TRW				
343								
1.4	47	02/76 → 08/92	FCP370	LUCAS/TRW				
1.4	47	02/76 → 08/92	FCP810	LUCAS/TRW				
2.0	71	02/76 → 08/92	FCP370	LUCAS/TRW				
2.0	71	02/76 → 08/92	FCP810	LUCAS/TRW				
345								
2.0	71	06/79 → 12/92	FCP370	LUCAS/TRW				
360								
1.4		01/76 → 08/79	FCP810	LUCAS/TRW				
1.4		09/79 → 12/91	FCP370	LUCAS/TRW				
66								
1.3	42	01/75 → 09/80	FCP3	ATE				
740								
All i		01/83 → 10/91			FCP2	ATE		
760								
All i		01/82 → 07/91			FCP2	ATE		
All i		08/91 → 12/92			FCP2	ATE		
780								
2.0 i		01/88 → 12/90			FCP2	ATE		
2.4 i		01/88 → 12/90			FCP2	ATE		
2.8 Bertone	108, 125	08/86 → 07/90			FCP2	ATE		
850 (LS)								
2.0	105	06/91 → 12/96	FCP1285	ATE				
2.0	105	06/91 → 12/96			FCP2	ATE		
2.4	103	06/91 → 07/94	FCP1285	ATE				
2.4	103	06/91 → 07/94			FCP2	ATE		
2.4	125	08/91 → 12/96	FCP1285	ATE				
2.4	125	08/91 → 12/96			FCP2	ATE		
2.5 TDI	103	08/95 → 12/96	FCP1285	ATE				
2.5 TDI	103	08/95 → 12/96			FCP2	ATE		
850 Estate (LW)								
2.0	105	02/93 → 12/96	FCP1285	ATE				
2.0	105	02/93 → 12/96			FCP2	ATE		
2.4	103	08/92 → 07/94	FCP1285	ATE				
2.4	103	08/92 → 07/94			FCP2	ATE		
2.4	125	09/92 → 12/96	FCP1285	ATE				
2.4	125	09/92 → 12/96			FCP2	ATE		
2.5 TDI	103	08/95 → 12/96	FCP1285	ATE				
2.5 TDI	103	08/95 → 12/96			FCP2	ATE		
940								
All i		08/90 → 09/93			FCP2	ATE		
960								
All i Saloon		08/90 → 08/93			FCP2	ATE		
All i Saloon		09/93 → 11/94			FCP2	ATE		
All i Saloon		11/94 → 10/96			FCP2	ATE		
All i SW Estate		08/90 → 08/93			FCP2	ATE		
All i SW Estate		09/93 → 10/96			FCP2	ATE		
C30								
1.6	74	10/06 → 12/12			FCP1931	ATE		
1.6 D	80	10/06 → 12/12			FCP1931	ATE		
1.6 D2	84	10/10 → 12/12			FCP1931	ATE		
1.8	92	10/06 → 12/12			FCP1931	ATE		
1.8 FlexFuel	92	01/07 → 12/12			FCP1931	ATE		
2.0	107	10/06 → 12/12			FCP1931	ATE		
2.0 D	100	10/06 → 12/12			FCP1931	ATE		
2.0 FlexFuel	107	01/10 → 12/12			FCP1931	ATE		
2.4 i	125	10/06 → 12/12			FCP1931	ATE		
D3	110	10/10 → 12/12			FCP1931	ATE		

For material availability see page 16-18 / Per la disponibilità materiali vedere a pagina 16-18

1256



KW



...VOLVO			NOTE			NOTE		
...C30								
D4	130	10/10 → 12/12				FCP1931	ATE	
D5	120	10/06 → 12/12				FCP1931	ATE	
D5	132	10/06 → 12/12				FCP1931	ATE	
T5	162	10/06 → 12/12	FCP1706	ATE	For Rims 17 inch			
T5	162	10/06 → 12/12				FCP1931	ATE	
T5	169	03/07 → 12/12	FCP1706	ATE	For Rims 17 inch			
T5	169	03/07 → 12/12				FCP1931	ATE	
C70								
2.0 T5 20V		06/97 →	FCP1285	ATE				
2.0 T5 20V		06/97 →				FCP2	ATE	
2.3 i T5 20V	177	06/97 →	FCP1285	ATE				
2.3 i T5 20V	177	06/97 →				FCP2	ATE	
2.5 T 20V	142	06/97 →	FCP1285	ATE				
2.5 T 20V	142	06/97 →				FCP2	ATE	
C70 II Convertible								
2.0 D	100	01/08 →				FCP1931	ATE	
2.4	103	03/06 →				FCP1931	ATE	
2.4 i	125	03/06 →				FCP1931	ATE	
D3	110	10/10 →	FCP1706	ATE	For Rims 17 inch			
D3	110	10/10 →				FCP1931	ATE	
D4	130	10/10 →	FCP1706	ATE	For Rims 17 inch			
D4	130	10/10 →				FCP1931	ATE	
D5	132	03/06 →				FCP1931	ATE	
T5	162	03/06 →				FCP1931	ATE	
T5	169	03/07 →				FCP1931	ATE	
S40								
1.6 16V	77	03/96 → 12/98	FCP1093	LUCAS/TRW				
1.8 16V	85	03/96 → 12/98	FCP1093	LUCAS/TRW				
1.9 T4 16V	147	06/97 → 12/98	FCP1093	LUCAS/TRW				
1.9 TD	66	03/96 → 12/98	FCP1093	LUCAS/TRW				
2.0 16V	100	03/96 → 12/98	FCP1093	LUCAS/TRW				
S40 II (MS)								
1.6	74	01/05 →	FCP1706	ATE	For Rims 17 inch			
1.6	74	01/05 →				FCP1931	ATE	
1.6 D	81	01/05 →	FCP1706	ATE	For Rims 17 inch			
1.6 D	81	01/05 →				FCP1931	ATE	
1.6 D2	84	10/10 →	FCP1706	ATE	For Rims 17 inch			
1.6 D2	84	10/10 →				FCP1931	ATE	
1.8	92	04/04 →	FCP1706	ATE	For Rims 17 inch			
1.8	92	04/04 →				FCP1931	ATE	
1.8 FlexFuel	92	01/06 →	FCP1706	ATE	For Rims 17 inch			
1.8 FlexFuel	92	01/06 →				FCP1931	ATE	
2.0	107	10/06 →	FCP1706	ATE	For Rims 17 inch			
2.0	107	10/06 →				FCP1931	ATE	
2.0 D	100	01/04 →	FCP1706	ATE	For Rims 17 inch			
2.0 D	100	01/04 →				FCP1931	ATE	
2.0 D4	96	07/05 →	FCP1706	ATE	For Rims 17 inch			
2.0 D4	96	07/05 →				FCP1931	ATE	
2.0 F	107	10/06 →	FCP1706	ATE	For Rims 17 inch			
2.0 F	107	10/06 →				FCP1931	ATE	
2.4	103	01/04 →	FCP1706	ATE	For Rims 17 inch			
2.4	103	01/04 →				FCP1931	ATE	
2.4	125	01/04 →	FCP1706	ATE	For Rims 17 inch			
2.4	125	01/04 →				FCP1931	ATE	
2.4 AWD	125	08/06 →	FCP1706	ATE	For Rims 17 inch			
2.4 AWD	125	08/06 →				FCP1931	ATE	
2.4 D5	132	03/06 →	FCP1706	ATE	For Rims 17 inch			
2.4 D5	132	03/06 →				FCP1931	ATE	
D3	110	10/10 →	FCP1706	ATE	For Rims 17 inch			
D3	110	10/10 →				FCP1931	ATE	
D4	130	10/10 →	FCP1706	ATE	For Rims 17 inch			
D4	130	10/10 →				FCP1931	ATE	
T5	162	01/04 →	FCP1706	ATE	For Rims 17 inch			
T5	162	01/04 →				FCP1931	ATE	
T5	169	03/07 →	FCP1706	ATE	For Rims 17 inch			
T5	169	03/07 →				FCP1931	ATE	
T5 AWD	162	04/04 →	FCP1706	ATE	For Rims 17 inch			
T5 AWD	162	04/04 →				FCP1931	ATE	
T5 AWD	169	03/07 →	FCP1706	ATE	For Rims 17 inch			
T5 AWD	169	03/07 →				FCP1931	ATE	

VOLVO

For material availability see page 16-18 / Per la disponibilità materiali vedere a pagina 16-18



KW

**...VOLVO****S60**

2.0 i (Turbo) 20V	132	07/00 →	FCP1382	ATE
2.3 i (T5) 20V	195	07/00 →	FCP1382	ATE
2.4 i (Turbo) 20V	147	07/00 →	FCP1382	ATE
2.4 TDi 20V	96	03/01 →	FCP1382	ATE
2.5 i (Turbo) 20V	154	03/03 →	FCP1382	ATE
S60 R 2.5 T AWD	221	03/03 →	FCP1334	BREMBO
S60 R 2.5 T AWD	221	03/03 →		

S70

2.3 20V	177	01/97 → 11/00	FCP1285	ATE
2.3 20V	177	01/97 → 11/00		
2.5 20V	106, 125	01/97 → 11/00	FCP1285	ATE
2.5 20V	106, 125	01/97 → 11/00		

S70 (LS)

2.0	105	01/97 → 11/00	FCP1285	ATE
2.0	105	01/97 → 11/00		
2.0	132	01/97 → 11/00	FCP1285	ATE
2.0	132	01/97 → 11/00		
2.0	93	01/97 → 11/00	FCP1285	ATE
2.0	93	01/97 → 11/00		

S80

2.0 i (Turbo) 20V		07/98 →	FCP1382	ATE
2.4 20V		07/98 →	FCP1285	ATE
2.4 D	96	08/01 →	FCP1382	ATE
2.4 TDi D5	120	08/01 →	FCP1382	ATE
2.5 TDi		07/98 →	FCP1382	ATE
2.8 i T6 24V		07/98 →	FCP1382	ATE
2.9 i 24V		07/98 →	FCP1382	ATE

S80 II

2.0	107	01/08 →		
2.0D	100	01/08 →		
2.4 D	120	03/06 →		
2.4 D5	136	03/06 →		
2.5 T	147	03/06 →		
3.0 T6	210	01/07 →		
3.2	175	03/06 →		
4.4 V8	232	03/06 →		

V40

1.6 16V	77	03/96 → 12/98	FCP1093	LUCAS/TRW
1.8 16V	85	03/96 → 12/98	FCP1093	LUCAS/TRW
1.9 16V	147	06/97 → 12/98	FCP1093	LUCAS/TRW
1.9 TD	66	03/96 → 12/98	FCP1093	LUCAS/TRW
2.0 16V	100	03/96 → 12/98	FCP1093	LUCAS/TRW

V50 (MW)

1.6	74	01/05 →	FCP1706	ATE	For Rims 17 inch
1.6	74	01/05 →			
1.6 D	81	01/05 →	FCP1706	ATE	For Rims 17 inch
1.6 D	81	01/05 →			
1.6 D2	84	01/10 →	FCP1706	ATE	For Rims 17 inch
1.6 D2	84	01/10 →			
1.8	92	04/04 →	FCP1706	ATE	For Rims 17 inch
1.8	92	04/04 →			
1.8 FlexFuel	92	01/05 →	FCP1706	ATE	For Rims 17 inch
1.8 FlexFuel	92	01/05 →			
2.0	107	10/06 →	FCP1706	ATE	For Rims 17 inch
2.0	107	10/06 →			
2.0 D	100	04/04 →	FCP1706	ATE	For Rims 17 inch
2.0 D	100	04/04 →			
2.0 FlexFuel	107	01/10 →	FCP1706	ATE	For Rims 17 inch
2.0 FlexFuel	107	01/10 →			
2.4	103	04/04 →	FCP1706	ATE	For Rims 17 inch
2.4	103	04/04 →			
2.4	125	04/04 →	FCP1706	ATE	For Rims 17 inch
2.4	125	04/04 →			
2.4 AWD	125	08/06 →	FCP1706	ATE	For Rims 17 inch
2.4 AWD	125	08/06 →			
2.4 D5	132	03/06 →	FCP1706	ATE	For Rims 17 inch
2.4 D5	132	03/06 →			
2.4 Tdi	120	05/07 →	FCP1706	ATE	For Rims 17 inch
2.4 Tdi	120	05/07 →			
D3	110	10/10 →	FCP1706	ATE	For Rims 17 inch

NOTE**NOTE**

For material availability see page 16-18 / Per la disponibilità materiali vedere a pagina 16-18

1258

FERODO

RACING

Updated on 17th Aug 2018



KW



...VOLVO								
						NOTE		
...V50 (MW)								
D3	110	10/10 →				FCP1931	ATE	
D4	130	10/10 →	FCP1706	ATE	For Rims 17 inch	FCP1931	ATE	
D4	130	10/10 →						
T5	162	04/04 →	FCP1706	ATE	For Rims 17 inch			
T5	162	04/04 →				FCP1931	ATE	
T5	169	03/07 →	FCP1706	ATE	For Rims 17 inch			
T5	169	03/07 →				FCP1931	ATE	
T5 AWD	162	04/04 →	FCP1706	ATE	For Rims 17 inch			
T5 AWD	162	04/04 →				FCP1931	ATE	
T5 AWD	169	03/07 →	FCP1706	ATE				
T5 AWD	169	03/07 →				FCP1931	ATE	
V70								
2.0 i (Turbo) 20V	132	07/01 →	FCP1382	ATE				
2.3 20V	177	01/97 → 02/00	FCP1285	ATE				
2.3 20V	177	01/97 → 02/00				FCP2	ATE	
2.3 i T5	184	03/00 →	FCP1382	ATE				
2.4 i (Turbo)	147	03/00 →	FCP1382	ATE				
2.4 TD D5	120	03/00 →	FCP1382	ATE				
2.5 TDi	103	03/00 →	FCP1382	ATE				
V70 I (LV)								
2.0	132	11/96 → 03/00	FCP1285	ATE				
2.0	132	11/96 → 03/00				FCP2	ATE	
2.0	93	12/95 → 03/00	FCP1285	ATE				
2.0	93	12/95 → 03/00				FCP2	ATE	
2.0 Turbo	166	11/96 → 12/00	FCP1285	ATE				
2.0 Turbo	166	11/96 → 12/00				FCP2	ATE	
2.4	103	03/99 → 12/00	FCP1285	ATE				
2.4	103	03/99 → 12/00				FCP2	ATE	
2.4	106	12/95 → 03/00	FCP1285	ATE				
2.4	106	12/95 → 03/00				FCP2	ATE	
2.4 Bifuel	103	08/99 → 12/00	FCP1285	ATE				
2.4 Bifuel	103	08/99 → 12/00				FCP2	ATE	
2.4 Bifuel	106	05/98 → 12/99	FCP1285	ATE				
2.4 Bifuel	106	05/98 → 12/99				FCP2	ATE	
2.4 Turbo	142	04/96 → 12/00	FCP1285	ATE				
2.4 Turbo	142	04/96 → 12/00				FCP2	ATE	
2.4 Turbo AWD	142	04/96 → 12/00	FCP1285	ATE				
2.4 Turbo AWD	142	04/96 → 12/00				FCP2	ATE	
V70 II								
R 2.5 T AWD	221	03/03 →	FCP1334	BREMBO				
R 2.5 T AWD	221	03/03 →				FCP1348	BREMBO	
V70 III								
2.0	107	10/07 →				FCP1917	LUCAS/TRW	Without EPB
2.0D	100	10/07 →				FCP1917	LUCAS/TRW	Without EPB
2.4 D	120	03/06 →				FCP1917	LUCAS/TRW	Without EPB
2.4 D5	136	08/07 →				FCP1917	LUCAS/TRW	Without EPB
2.5 T	147	08/07 →				FCP1917	LUCAS/TRW	Without EPB
3.0 T6	210	08/07 →				FCP1917	LUCAS/TRW	Without EPB
3.2	175	08/07 →				FCP1917	LUCAS/TRW	Without EPB
XC70 II								
2.4 D	120	08/07 →				FCP1917	LUCAS/TRW	Without EPB
2.4 D5	136	08/07 →				FCP1917	LUCAS/TRW	Without EPB
3.2	175	08/07 →				FCP1917	LUCAS/TRW	Without EPB
XC90								
2.5 T (not for 16")	154	10/02 →	FCP1631	ATE				
3.0 T6 (not for 16")	200	10/02 →	FCP1631	ATE				
3.2 AWD	175	05/06 →	FCP1631	ATE	not for 16 inch			
3.2 AWD	179	04/10 →	FCP1631	ATE	not for 16 inch			
4.4 V8 (not for 16")	232	01/05 →	FCP1631	ATE				
D3 / D5	120	04/09 →	FCP1631	ATE	17 inch			
D5	136	05/06 →	FCP1631	ATE	17 inch			
D5	147	01/11 →	FCP1631	ATE	17 inch			

WARTBURG

For material availability see page 16-18 / Per la disponibilità materiali vedere a pagina 16-18



KW

**WARTBURG****311**

1.1 (A.W.E.) 01/83 →

FCP461 ATE

NOTE

NOTE

353

1.0 37 02/75 → 01/89

FCP461 ATE

1.3 (A.W.E.) 43 01/83 →

FCP461 ATE

YUGO**311**

1.1 (Zastava) 41 01/83 → 08/87

FCP29 BENDIX

313

1.3 (Zastava) 47 01/83 → 07/88

FCP29 BENDIX

411

1.1 (Zastava) 41 01/84 → 12/86

FCP29 BENDIX

413

1.3 (Zastava) 47 01/84 → 12/86

FCP29 BENDIX

45

0.9 (Zastava) 48 04/80 → 04/91

FCP29 BENDIX

511

1.1 (Zastava) 41 01/83 → 08/90

FCP29 BENDIX

513

1.3 (Zastava) 47 01/83 → 06/90

FCP29 BENDIX

65

1.3 (Zastava) 50 04/80 → 04/91

FCP29 BENDIX

Florida

1.4 (Zastava) 52 01/90 →

FCP524 LUCAS/TRW

Miami

1.4 (Zastava) 52 11/89 →

FCP524 LUCAS/TRW

Sana

1.4 (Zastava) 52 11/89 → 10/93

FCP524 LUCAS/TRW

Tempo

0.9 (Zastava) 33 05/91 → 12/93

FCP29 BENDIX

1.1 (Zastava) 41 05/91 → 12/93

FCP29 BENDIX

1.3 (Zastava) 48 02/91 → 05/98

FCP29 BENDIX

1.3 Zastava 10/83 → 12/89

FCP29 BENDIX

WARTBURG

For material availability see page 16-18 / Per la disponibilità materiali vedere a pagina 16-18

1260

FERODO

RACING

Updated on 17th Aug 2018

FERODO[®]

PADS FOR RACING CALIPERS



FERODO[®]

RACING

PADS FOR RACING CALIPERS

PASTIGLIE PER PINZE DA COMPETIZIONE



...ALCON

Advantage Extreme 4 piston	FRP3135
Advantage Extreme 6 piston	FRP3134
B type - Th. 16.0mm	FRP1077
B type - Th. 18.0mm	FRP3007
B type - Th. 20.0mm	FRP302
B type - Th. 25.0mm	FRP1078
F type - Th. 28mm	FRP3059
H type - Th. 16.0mm	FRP218
H type - Th. 16.0mm	FRP219
K type - Th. 16mm	FRP3009
K type - Th. 20mm	FRP3012
PNF0083X264	FRP201
PNF0084X222 (Truck pad)	FRP3027
PNF0084X225	FRP3001
PNF0084X245	FRP216
PNF0084X265	FRP1077
PNF0084X272	FRP1058
PNF0084X276	FRP3018
PNF0084X282	FRP1064
PNF0084X283	FRP3004
PNF0084X284	FRP502
PNF0084X288	FRP216
PNF0084X304	FRP3028
PNF0084X305	FRP3025
PNF0084X306	FRP3025
PNF0084X322	FRP1079
PNF0084X331	FRP216
PNF3430X275	FRP3043
PNF4441X634	FRP302
PNF4441X714	FRP1077
PNF4441X723	FRP1077
PNF4441X728	FRP302
PNF4441X737	FRP302
PNF4441X754	FRP302
PNF4463X529	FRP219
PNF4463X551	FRP218
PNF4463X553	FRP218
PNF4463X554	FRP201
PNF4463X555	FRP201
PNF4463X568	FRP201
PNF4463X572	FRP219
PNF4476X541 / 545	FRP3009
PNF4476X549	FRP3012
PNF4489X519	FRP3000
PNF4489X532	FRP3003
PNF4489X534	FRP3000
PNF4489X543	FRP3015
PNF4489X544	FRP3015
PNF4489X562	FRP3000
PNF4493X501	FRP3026

PNF4493X503	FRP3026
PNF4493X603	FRP3044
PNF4495X501	FRP3039
PNF4495X504	FRP3037
PNF4495X505	FRP3039
PNF4496X515 (Subaru WRC 03 Front) - Th. 18mm	FRP3074
PNF4497x607 - Monoblock 6 - Th. 16mm	FRP3081
PNF4498x603 - Monoblock 4 - Th. 15mm	FRP3082
R type - Th. 14.4mm	FCP809
R type - Th. 14.4mm	FCP810
Subaru Impreza Alcon/Prodrive kit - Th. 16.0mm	FRP1077
TA 6 - Th. 20mm	FRP3014
TA 6+ type - Th. 20mm	FRP3039
Type 6 x 2 - Th. 16.0mm	FRP3006
XF type (scalloped) - Th. 28mm	FRP3060
XR 6 type - Th. 28mm	FRP3015

AP RACING

"CP5111 Family"	FCP1562
A1GP cars 2006-2007	FRP3073
AP Caliper families taking CP2712D44 pad	FCP840
CP 2485 - Th. 14.4mm	FCP825
CP 2576 - Th. 14.4mm	FCP825
CP 2577 - Th. 14.4mm	FCP825
CP 3176 - Th. 14.4mm	FCP825
CP 3177 - Th. 14.4mm	FCP825
CP 3178 - Th. 14.4mm	FCP825
CP 3676 - Th. 14.4mm	FCP825
CP 3677 - Th. 14.4mm	FCP825
CP 4586 - Th. 14.4mm	FCP825
CP 4596 - Th. 14.4mm	FCP825
CP 5211 - Th. 14.4mm	FCP825
CP 5310 - Th. 14.4mm	FCP825
CP 5311 - Th. 14.4mm	FCP825
CP2195	FCP342
CP2270 - Th. 15.0mm	FRP203
CP2271 - Th. 15.0mm	FRP203
CP2279 - Th. 16.7mm	FRP3018
CP2279 - Th. 20.3mm	FRP3073
CP2279 - Th. 20.3mm	FRP212
CP2340	FRP3021
CP2361	FRP218
CP2361	FRP201
CP2373	FRP202
CP2382	FRP202
CP2383	FRP202
CP2384	FRP202
CP2425	FRP203
CP2575	FRP203
CP2696	FCP342
CP2749 - Th. 28mm	FRP3059
CP2749 Th. 28mm	FRP3060

PADS FOR RACING CALIPERS

PASTIGLIE PER PINZE DA COMPETIZIONE



...AP RACING

CP2831	FRP203
CP2876	FRP203
CP2986	FRP203
CP3008	FRP203
CP3009	FRP203
CP3215	FRP3018
CP3215 - Th. 16.8mm (previously FRP3072)	FRP3091
CP3307 - Th. 17.0mm	FRP216
CP3344 - Th. 16.0mm	FRP219
CP3345 - Th. 16.0mm	FRP219
CP3395 - Th. 20.3mm	FRP212
CP3558	FRP3014
CP3558	FRP3061
CP3558	FRP1060
CP3620	FRP216
CP3714	FRP217
CP3720 - Th. 17.0mm	FRP216
CP3788 - Th. 20.3mm	FRP212
CP3789 - Th. 20.3mm	FRP212
CP3796	FRP3006
CP3796 - Th. 18.0mm	FRP3000
CP3799 - Th. 20.3mm	FRP212
CP3894 - Th. 18.0mm	FRP3000
CP3894 - Th. 18mm	FRP3054
CP3996 - Th. 18.0mm	FRP3000
CP4090 - Th. 18.0mm	FRP3000
CP4096 - Th. 18.0mm	FRP3000
CP4098 - Th. 18.0mm	FRP3000
CP4140	FRP3001
CP4152 - Th. 16.0mm	FRP219
CP4218 - Th. 25mm	FRP3014
CP4230 - Th. 28.5mm	FRP3015
CP4270	FRP203
CP4296	FRP1061
CP4567 - Th. 16.0mm	FRP219
CP4595	FRP3015
CP4751	FRP501
CP4848	FRP3086
CP4890 - Th. 16.0mm	FRP216
CP5020	FCP825
CP5040-20-23	FRP216
CP5060-2 to -5 / CP5555	FRP3003
CP5070 - Th. 17mm	FRP3077
CP5070 - Th. 17mm	FRP3076
CP5100 - Th. 16.0mm	FRP219
CP5104 - Th. 16.0mm	FRP219
CP5119	FRP3056
CP5148	FRP3020
CP5148 - Th. 18mm	FRP3086
CP5555 - Th. 18mm	FRP3054

CP5570 Kits - Th. 17mm	FRP3076
CP5575-1004 (Big Brake Kit)	FRP3077
CP5788	FRP3024
CP5805	FRP503
CP5820 - Th. 30mm	FRP3040
CP6210 - Th. 28mm	FRP3037
CP6210 -Th. 30mm	FRP3055
CP6230 - Th. 25mm	FRP3039
CP6268 (e.g. V8 Supercar)	FRP3131
CP6276	FRP3150
CP6600	FRP3107
CP6600 - Th. 16.9mm	FRP3083
CP6627	FRP3115
CP6720	FRP216
CP6730	FRP216
CP6740	FRP216
CP6840	FRP1078
CP7031 - Th. 16mm (F3 system)	FRP3102
CP7040	FRP3114
CP7040 - Th. 16.9mm	FRP3084
CP7600 - Th. 16.1mm	FRP3085
CP7611-1000	FRP3085
CP7635 D40	FCP4972
CP8310	FRP3027
CP8350	FRP3116
CP8350 - Th. 20mm	FRP3097
CP8351	FRP3116
CP8520	FRP3147
CP8521	FRP3147
CP8522	FRP3147
CP9660	FRP3144
F3	FRP3021
SC 200 - Th. 20.0mm	FRP501
SC 240 - Th. 20.0mm	FRP308
SC 300 - Th. 20.0mm	FRP501
SC 350 - Th. 20.0mm	FRP501
SC 360 - Th. 20.3mm	FRP503
SC 500 - Th. 28mm	FRP3059
SC 560 - Th. 20.3mm	FRP503
SC 660 - Th. 25mm	FRP3014
SC 660 - Th. 28.5mm	FRP3015
SC 670 - Th. 25mm	FRP3014
SC 670 - Th. 28.5mm	FRP3015
SC 680 - Th. 30mm	FRP3040
Subaru 06 MY VO Gr N - Rear - Th. 16.0mm	FRP219

AP RACING/BREMBO

AP Racing/Brembo handbrake	FRP3126
----------------------------	---------

BREMBO

07.5064.7	FRP308
07.5064.8	FRP1079

PADS FOR RACING CALIPERS

PASTIGLIE PER PINZE DA COMPETIZIONE



...BREMBO

07.5139.	FRP3032
07.5139.0	FRP1077
07.5139.3	FRP1078
07.5139.6	FRP302
07.5169.9	FRP3024
07.5308.9	FRP3042
07.5684.2	FRP1064
07.5684.2	FRP1058
07.5684.5	FRP3022
07.5684.5	FRP3023
07.5684.8	FRP3033
07.5868.	FRP1059
07.5868.2	FRP3004
07.6955.3	FRP3053
07.7293.6	FRP3031
07.7614.2	FRP3040
07.7614.3	FRP3046
07.7810.1	FRP3035
07.7810.2	FRP3034
07.7810.3	FRP3045
07.7859.1	FRP3029
07.7859.2	FRP3030
07.7869.12	FRP3070
07.A262.20 - Th. 16mm (New Brembo F3 System 2007->)	FRP3103
107.8590.15 Nissan GTR (R35)	FRP3106
20.3655.01 - Th. 14.4mm	FCP825
20.4548.03 - Th. 25.0mm	FRP1078
20.4862.05 - Th. 18.4mm	FCP1281
20.5187.30 - Th. 17.3mm	FCP721
6 piston D48	FRP3099
6 piston D58	FRP3098
6 Pistons	FRP3100
6 Pistons - narrow annulus - Th. 27.8mm	FRP3080
Brembo F3 System (prior 2007) - Th. 16mm	FRP3071
Brembo System - S2000 Asphalt - Th. 17.5mm	FRP3088
Brembo System - S2000 Gravel - Th. 17.5mm	FRP3087
FERRARI 458 GT3	FRP3128
Ford WRC - Th. 16mm	FRP3022
GT front - Th. 29mm	FRP3031
GT3 caliper 2009	FRP3110
M8 (8 pistons caliper)	FCP4611
Mitsubishi EVO IX-X Gr N - Front Asphalt - Th. 17.5mm	FRP3088
Mitsubishi EVO IX-X Gr N - Front Gravel - Th. 17.5mm	FRP3087
Mitsubishi EVO IX-X Gr N - Rear - Th. 20mm	FRP308
Nascar - Th. 20.0mm	FRP308
VW upgrade Kit 2009 (SEAT Force, Leon II, Ibiza 6L / VW Golf IV-V)	FRP3109
x2.023.21 - Th. 20mm	FRP3024
x2.028.01 - Th. 20mm	FRP3024
x2.029.21 - Th. 20.0mm	FRP308
x2.029.71 - Th. 20.0mm	FRP308

x2.040.01 - Th. 16.0mm	FRP1079
X2.046.01 - Th. 18mm	FRP3070
x6.059.41 - Th. 20.0mm	FRP308
x9.005.91 - Th. 16.0mm	FRP1077
x9.011.01 - Th. 20.0mm	FRP308
x9.011.31 - Th. 20.0mm	FRP308
x9.014.03 - Th. 20.0mm	FRP308
x9.060.51 - Th. 25.0mm	FRP1078
x9.060.71 - Th. 26mm	FRP3028
x9.066.91 - Th. 16.0mm	FRP1079
X93.41.21/24 (8 Pistons WRC TARMAC & Touring Car)	FRP3113
x93.41.41 - Th. 20.0mm	FRP1064
x93.45.01 - Th. 26mm	FRP3029
x93.45.11 - Th. 27.5mm	FRP3053
x93.73.01 - Th. 20.0mm	FRP1064
x93.73.11 - Th. 20.0mm	FRP1064
x94.44.11 - Th. 21mm	FRP3034
X94.44.21	FRP3004
x94.75.11 - Th. 16.0mm	FRP1079
XA3.02.31/32 (6 POT)	FRP3031
XA5.E8.K1 + XA4.17.K7/K8	FRP3109
XA6.S0.01/04	FRP3103

CAPARO

F.Renault 2010 -> front & rear	FRP3117
--------------------------------	---------

CHEVROLET CRUZE CUP

ATE Kit	FRP3122
---------	---------

CL BRAKES

5015W58T17	FRP3078
------------	---------

COLEMAN

GM type - Th. 15mm	FRP3057
Series I,II - Th. 20.0mm	FRP501
Series III	FRP3070
Series IV - Th. 18.0mm	FRP3003

HOWE

GM type - Th. 15mm	FRP3057
--------------------	---------

JAS

Honda Civic Type R - Rally R3 Gravel [JAS Motorsport]	FRP3105
---	---------

JFZ / SIERRA

GM type - Th. 15mm	FRP3057
GN series - Th. 20.3mm	FRP503
Mini GN dual - Th. 12.4mm	FRP502
Mini GN single - Th. 13.0mm	FRP506
XL series - Th. 20.3mm	FRP503

KSPORT

12 pistons 380mm	FCP1625
------------------	---------

PADS FOR RACING CALIPERS

PASTIGLIE PER PINZE DA COMPETIZIONE



...KSPORT

4 pistons 330/356mm	FRP219
6 pistons 286/304mm	FRP216
8 pistons 356mm	FRP3077
8 pistons 380mm	FCP1664

LOCKHEED

LD - 20 - Th. 14.4mm	FCP825
LD -19 - Th. 10.4mm	FCP342

LUCAS GIRLING

"12/3"	FCP815
"17/3"	FCP9
14LF & D14R	FCP809
AR	FRP5002
AR MK5	FRP101
M16	FCP167

MANDO

Mono block 4P Caliper	FCP4671
-----------------------	---------

MWE

Drag 2 piston - Th. 15.0mm	FRP506
----------------------------	--------

OUTLAW

1000 - Th. 13.0mm	FRP506
1500 - Th. 13.0mm	FRP506
2000 / 2500 - Th. 12.4mm	FRP502
3000 / 3500 / 4000 - Th. 20.0mm	FRP501
9000 - Th. 28mm	FRP3059
Bridgebolt 2000 - Th. 12.4mm	FRP504
Bridgebolt 2500 - Th. 12.4mm	FRP504

PBR

Corvette Z06 C6 3 sets front axle 2 sets rear axle	FRP3094
--	---------

PFC

F3 Brake System FRONT-REAR - Th. 18mm [P7835]	FRP3092
---	---------

PORSCHE

GT3 Super Cup - Front	FRP3123
GT3 Super Cup 2011 - Rear	FRP302

RACING APPLICATION

FORD WRC	FRP3022
----------	---------

RACING FITMENT

Acura / Honda / Rover (as FCP905 but Th. 19.5mm)	FRP3062
Buick - front and rear	FRP3057
Cadillac, Chevrolet, Jeep, Oldsmobile, Pontiac - front	FRP3057
Ferrari Challenge 3.6 ->Rear, Adaptable to Tarox Caliper	FRP3078

JFZ / Sierra caliper GM type	FRP3057
------------------------------	---------

JFZ / Sierra caliper GN Series / XL Series	FRP503
--	--------

JFZ / Sierra caliper Mini GN single	FRP506
-------------------------------------	--------

Stock Cars	FRP3097
------------	---------

ROTORA

FC2	FCP1562
-----	---------

FC4	FRP3028
-----	---------

FC6	FRP3003
-----	---------

FC8	FCP1664
-----	---------

FF4	FRP1077
-----	---------

TAROX

TAROX B32-6 (6 pots) - adaptable	FRP3078
----------------------------------	---------

TOYOTA

TOYOTA Hi-Ace	FRP3127
---------------	---------

WILWOOD

Billet Dynalite - Side Inlet	FRP3149
------------------------------	---------

Billet DynaPro Lug Mount Calipers w/Dust Boots	FRP3149
--	---------

Billet Narrow Dynalite Radial Mount (7816)	FRP3148
--	---------

Billet Narrow Mount DynaPro (7816)	FRP3148
------------------------------------	---------

Billet Powerlite Calipers	FRP3108
---------------------------	---------

Billet Superlite 4 Radial & Lug Mount Calipers	FRP3097
--	---------

Billet Superlite 6 Lug Mount Calipers - Type 7420	FRP3097
---	---------

Billet Superlite 6R Radial Mount Calipers	FRP3097
---	---------

Cast Iron GM Metric Calipers	FRP3058
------------------------------	---------

Combination Parking Brake Calipers	FCP541
------------------------------------	--------

Dynalite b/bolt - Th. 12.4mm	FRP504
------------------------------	--------

Dynalite c/pin - Th. 12.4mm	FRP502
-----------------------------	--------

Dynalite single - Th. 13.0mm	FRP506
------------------------------	--------

Dynalite Single Floater Calipers	FRP3104
----------------------------------	---------

DynaPro Forged Billet Radial Mount (7816)	FRP3148
---	---------

DynaPro/Dynalite Single Calipers	FRP3104
----------------------------------	---------

Forged DPHA	FRP3149
-------------	---------

Forged Narrow Dynalite Lug Mount (7816)	FRP3148
---	---------

Forged Superlite FSL/ST Calipers	FRP3097
----------------------------------	---------

GM III Calipers	FRP3057
-----------------	---------

GN III Calipers	FRP503
-----------------	--------

GT 4000	FRP3070
---------	---------

GT 6000 - Th. 28mm	FRP3059
--------------------	---------

GT 6000 radius - Th. 28mm	FRP3060
---------------------------	---------

GT III - Th. 28mm	FRP3059
-------------------	---------

GT-III radius - Th. 28mm	FRP3060
--------------------------	---------

Integra GT - Th. 20mm	FRP3024
-----------------------	---------

Integra HP - Th. 27.5mm	FRP3053
-------------------------	---------

Integra IP - Th. 26mm	FRP3029
-----------------------	---------

IR - GT - Th. 20.0mm	FRP308
----------------------	--------

LC-GT - Th. 20.0mm	FRP501
--------------------	--------

Narrow Dynapro Radial Mount	FRP3149
-----------------------------	---------

SL-GT - Th. 20.0mm	FRP501
--------------------	--------

PADS FOR RACING CALIPERS

PASTIGLIE PER PINZE DA COMPETIZIONE



...WILWOOD

Superlite 4 - Th. 20.0mm	FRP501
Superlite 6 - Th. 20.0mm	FRP501

FERODO[®]

PAD DRAWINGS



FERODO[®]
RACING

FCP2

WVA No: 20034

FMSI No: D031

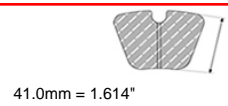
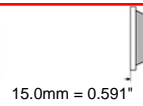
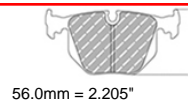
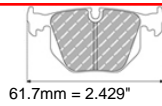

ALFA ROMEO Front / Rear, AUDI Front, BMW Front / Rear, FERRARI Rear, LANCIA Rear, MASERATI Rear, MATRA Front, MERCEDES Rear, OPEL Front / Rear, PORSCHE Front / Rear, SAAB Front, TALBOT Front, VAUXHALL Front / Rear, VOLKSWAGEN Front, VOLVO Rear

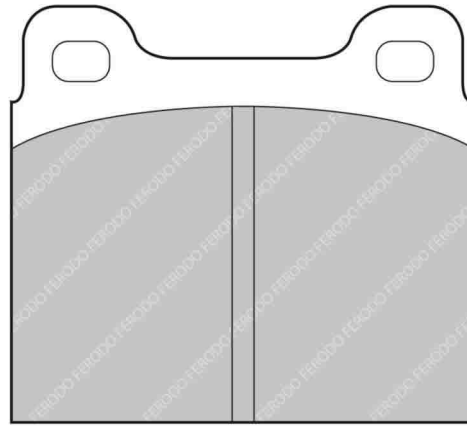

MATERIAL AVAILABILITY						
H	C	R	W	WB	Z	ZB
✓	✗	✓	✗		✗	

CROSS REFERENCE	
BREMBO	07.1715.50
CL BRAKES	4004
FMSI	D031
FMSI	D058
HAWK	HB172 0,595
MINTEX	MDB1002
MINTEX	MDB1068
PAGID	2723
PAGID	4304
PFC	0031.XX
WVA	20034

FCP3

WVA No: 20009 15,00

FMSI No: D30

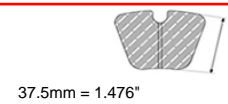
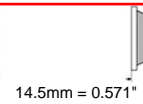
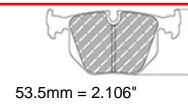
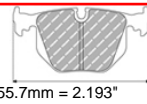

ALFA ROMEO Rear, BMW Rear, DAF Front, DKW Front, DODGE Front, GLAS Front / Rear, NSU Front, OPEL Front, PORSCHE Front / Rear, SAAB Rear, TALBOT Front, VOLVO Front

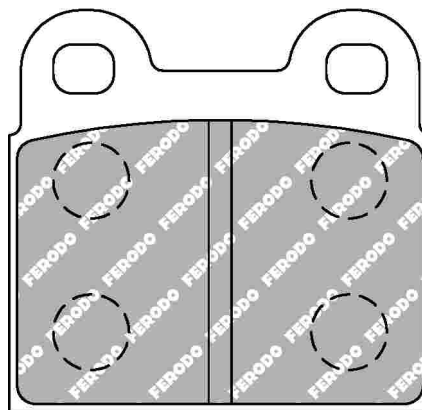

MATERIAL AVAILABILITY						
H	C	R	W	WB	Z	ZB
✓		✓	✗			

CROSS REFERENCE	
CL BRAKES	4056
FMSI	D30
MINTEX	MDB1012
PAGID	4122
WVA	20009 15,00

3000

FERODO
RACING
Updated on 17th Aug 2018

✓ Available ⚠ Exhausting
 ✗ Out of Range 📦 Make to order
 🔄 In Introduction

FCP9

WVA No: 20027 16,00

FMSI No: D004



98.4mm = 3.874"



68.0mm = 2.677"



16.0mm = 0.630"

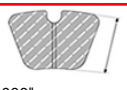

50.8mm = 2.000"

AC Front, ASTON MARTIN Front, BRISTOL Front, FERRARI Front, FIAT Front, JAGUAR Front, JENSEN Front, LOTUS Front, ROVER Front, VOLVO Front

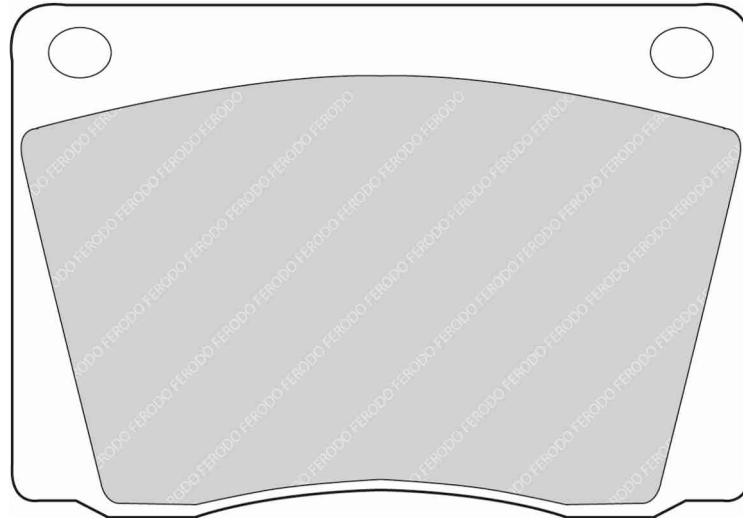

MATERIAL AVAILABILITY						
H	C	R	W	WB	Z	ZB
✓		✓				

CROSS REFERENCE	
CL BRAKES	4114
EBC	DP108
FMSI	D004
MINTEX	MDB1499
MINTEX	MGB522
PAGID	8042
PAGID	ERS496
WVA	20027 16,00

✓ Available ⚠ Exhausting
 ✗ Out of Range 📦 Make to order
 📌 In Introduction

FCP11

WVA No: 20011 15,00

FMSI No: D045



76.7mm = 3.020"



70.0mm = 2.756"



15.0mm = 0.591"



55.0mm = 2.165"

ALFA ROMEO Front, FERRARI Front, GLAS Front, LANCIA Front, MERCEDES Front, OPEL Front, PORSCHE Front / Rear, VAUXHALL Front

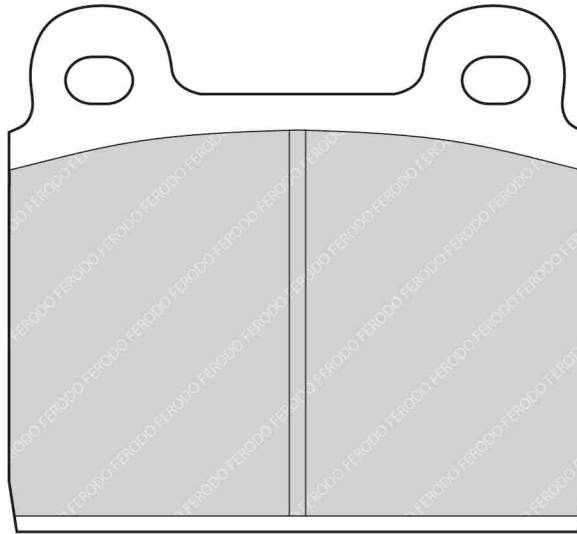

MATERIAL AVAILABILITY

H	C	R	W	WB	Z	ZB
✓		✓	✉		✓	

CROSS REFERENCE

CL BRAKES	4003
FMSI	D045
FMSI	D287
HAWK	HB171 0,59
MINTEX	MDB1003
MINTEX	MDB1455
PAGID	4501
PAGID	4503
PFC	0045.XX
WVA	20011 15,00

FCP22

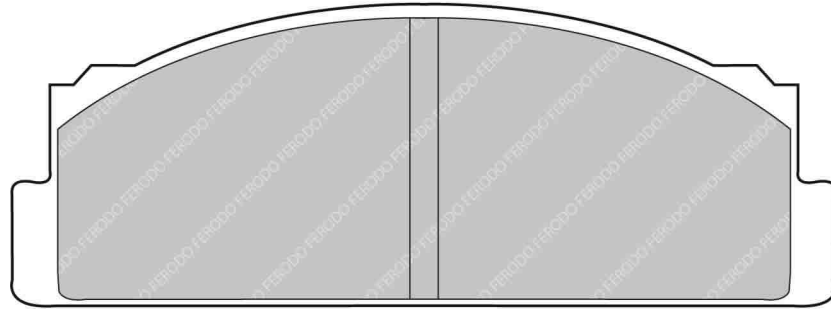
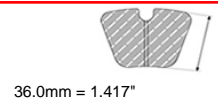
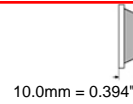
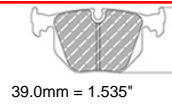
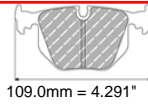

ALSO AVAILABLE

SHAPE	TH. MM	NOTES
FCP29	17,3	

CROSS REFERENCE

MINTEX	MDB1008
--------	---------

MATERIAL AVAILABILITY

H	C	R	W	WB	Z	ZB
✓						

FCP29

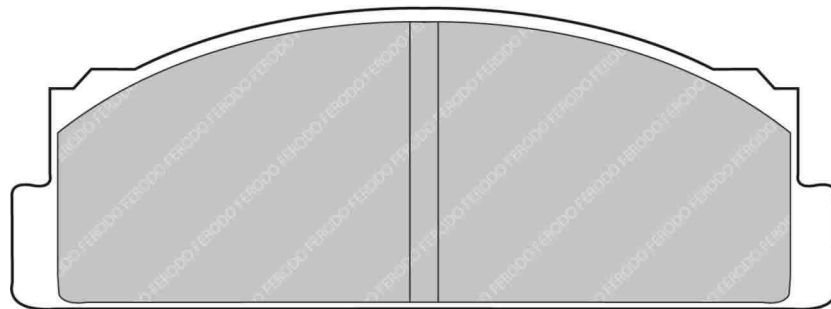
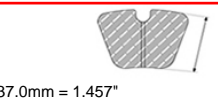
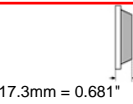
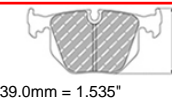
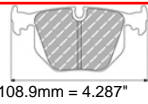

WVA No: 20073 17,50

FMSI No: D54

AUTOBIANCHI Front, FIAT Front, FSO Front, INNOCENTI Front, LANCIA Front, POLSKI Front, SEAT Front, YUGO Front

ALSO AVAILABLE

SHAPE	TH. MM	NOTES
FCP22	10	

CROSS REFERENCE

FMSI	D54
MINTEX	MDB1013
WVA	20073 17,50

MATERIAL AVAILABILITY

H	C	R	W	WB	Z	ZB
✓		✓				

FCP39

WVA No: 20128 14,70



58.1mm = 2.287"



55.1mm = 2.169"



14.6mm = 0.575"



38.0mm = 1.496"

HONDA Front, NISSAN Front

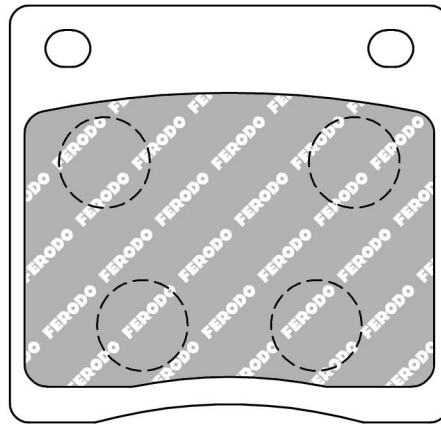

MATERIAL AVAILABILITY						
H	C	R	W	WB	Z	ZB

CROSS REFERENCE	
MINTEX	MDB1107
WVA	20128 14,70

FCP72

WVA No: 20140 14,00

FMSI No: D97



108.9mm = 4.287"



49.0mm = 1.929"



13.5mm = 0.531"



44.0mm = 1.732"

ABARTH Front, ALFA ROMEO Front, CITROEN Front, DACIA Front, FIAT Front, MATRA Rear, NISSAN Front, PEUGEOT Front, RENAULT Front / Rear, RENAULT-ALPINE Front / Rear, TALBOT Front

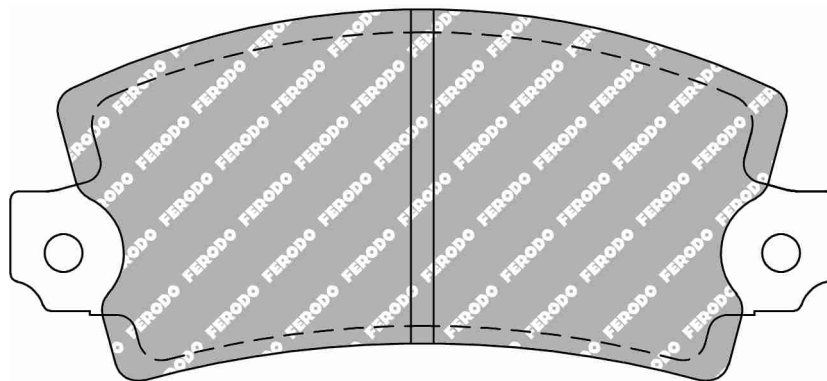

MATERIAL AVAILABILITY						
H	C	R	W	WB	Z	ZB

CROSS REFERENCE	
CL BRAKES	4062
FMSI	D97
WVA	20140 14,00

FCP93

WVA No: 20641 15,00

FMSI No: D127

ALFA ROMEO Rear, PORSCHE Rear



55.7mm = 2.193"



53.0mm = 2.087"



15.0mm = 0.591"

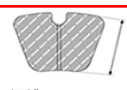

37.5mm = 1.476"

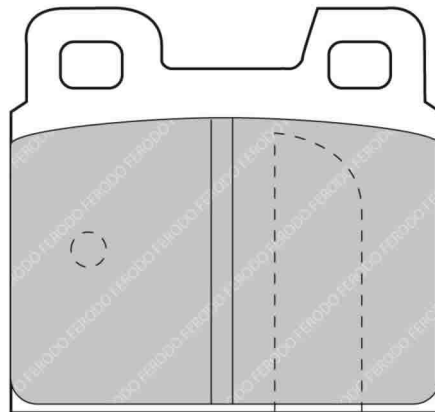

MATERIAL AVAILABILITY						
H	C	R	W	WB	Z	ZB
✓		✓				

CROSS REFERENCE	
FMSI	D127
MINTEX	MDB1072
WVA	20641 15,00

FCP96

WVA No: 20166 16,00

LADA Front



84.0mm = 3.307"



60.0mm = 2.362"



15.9mm = 0.626"



47.0mm = 1.850"

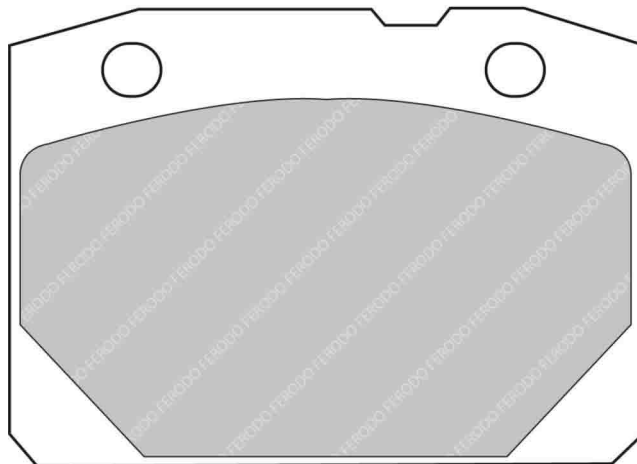

MATERIAL AVAILABILITY						
H	C	R	W	WB	Z	ZB
✓		✓				

CROSS REFERENCE	
MINTEX	MDB1074
WVA	20166 16,00

FCP105

WVA No: 20228 15,20

FMSI No: D096



61.7mm = 2.429"



57.0mm = 2.244"



15.2mm = 0.598"

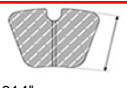

41.0mm = 1.614"

AUDI Front, VOLKSWAGEN Front

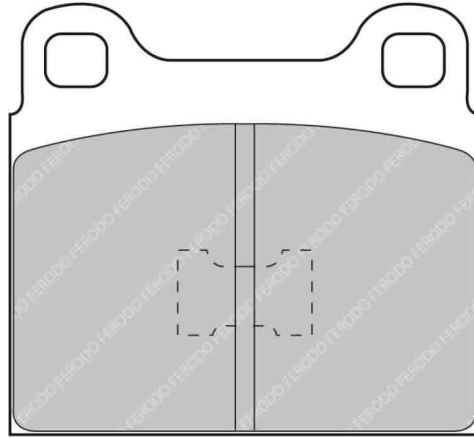

MATERIAL AVAILABILITY						
H	C	R	W	WB	Z	ZB

CROSS REFERENCE	
CL BRAKES	4009
FMSI	D096
HAWK	HB395 0,58
MINTEX	MDB1081
WVA	20228 15,20

FCP116

WVA No: 20323 16,50

FMSI No: D109



77.6mm = 3.055"



66.0mm = 2.598"



16.5mm = 0.650"

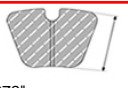

50.1mm = 1.972"

ALFA ROMEO Front, BMW Front, LOTUS Front, MORGAN Front, OPEL Front, VAUXHALL Front

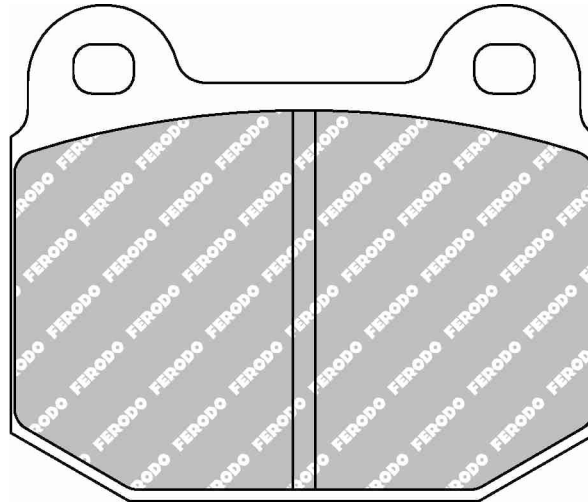

ALSO AVAILABLE

SHAPE	TH. MM	NOTES
FCP1562	14.5	different friction area
FRP3056	14.5	

MATERIAL AVAILABILITY

H	C	R	W	WB	Z	ZB
✓		✓			✉	

CROSS REFERENCE

CL BRAKES	4060
FMSI	D109
FMSI	D174
HAWK	HB180 0,64
MINTEX	MDB1099
PAGID	4507
PFC	0109.XX
PFC	0174.XX
WVA	20323 16,50

✓ Available ⚠ Exhausting
 ✗ Out of Range ✉ Make to order
 ⓘ In Introduction

FCP167

WVA No: 20491 15,20

FMSI No: D330

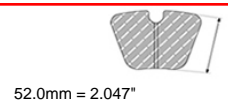
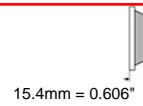
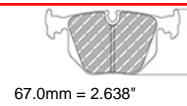
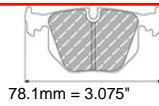

AC Front, CATERHAM Front, FORD Front, HYUNDAI Front, LOTUS Front, ROVER Front

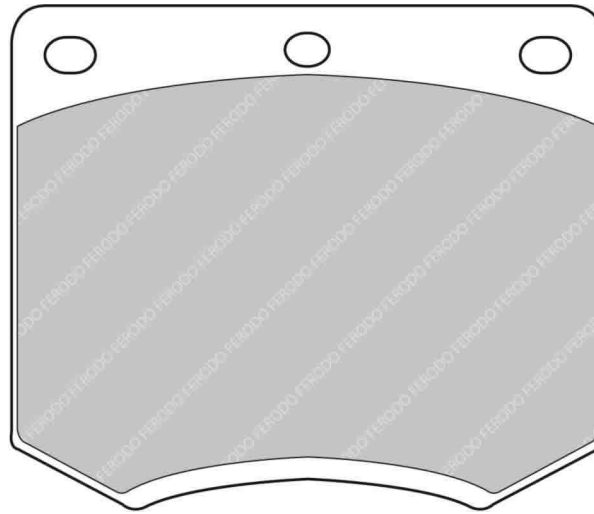

MATERIAL AVAILABILITY						
H	C	R	W	WB	Z	ZB
✓	✓	✓	✗		✓	

CROSS REFERENCE	
CL BRAKES	4085
EBC	DP2291
FMSI	D330
MINTEX	MGB633
PAGID	4905
WVA	20491 15,20

FCP170

WVA No: 20476 15,00

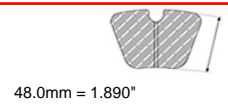
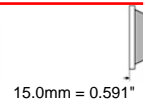
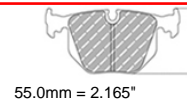
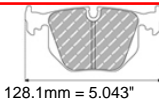

ASIA MOTORS Front, MAZDA Front, MITSUBISHI Front, TOYOTA Front

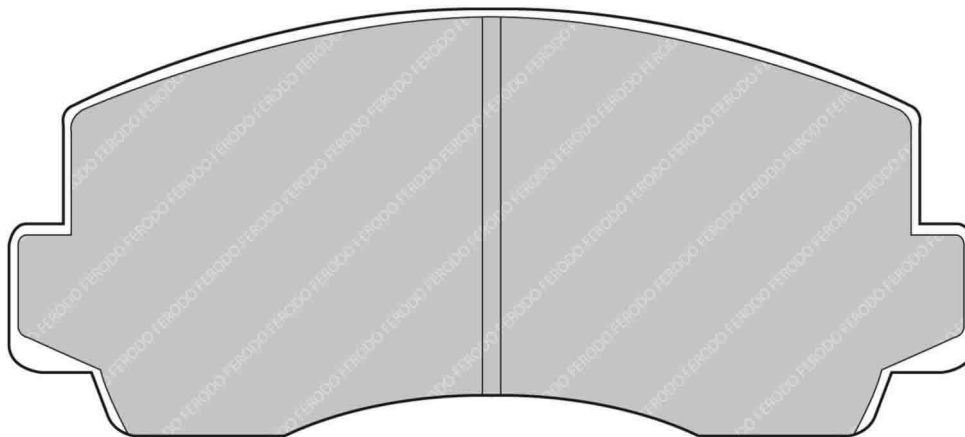

MATERIAL AVAILABILITY						
H	C	R	W	WB	Z	ZB
	✓					

CROSS REFERENCE	
MINTEX	MDB1607
PFC	0195
WVA	20476 15,00

FCP173

WVA No: 20939 15,90

FMSI No: D378



100.0mm = 3.937"



59.0mm = 2.323"



15.5mm = 0.610"

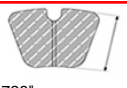

43.9mm = 1.728"

DAEWOO Front, OPEL Front, VAUXHALL Front

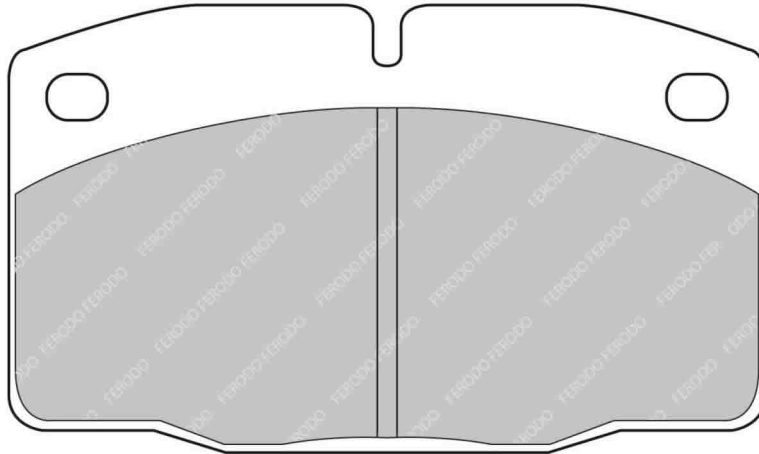

MATERIAL AVAILABILITY

H	C	R	W	WB	Z	ZB
✓		✓				

CROSS REFERENCE

BREMBO	07.8301.02
EBC	DP2325
FMSI	D378
MINTEX	MDB1141
WVA	20939 15,90

✓ Available ⚠ Exhausting
 ✗ Out of Range 📦 Make to order
 ⓘ In Introduction

FCP206

WVA No: 20640-20753 18,60

FMSI No: D350

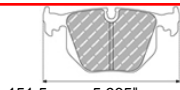

151.5mm = 5.965"



46.5mm = 1.831"



18.0mm = 0.709"



39.1mm = 1.539"

FERRARI Rear, FORD Front, KIA Front, TVR Front

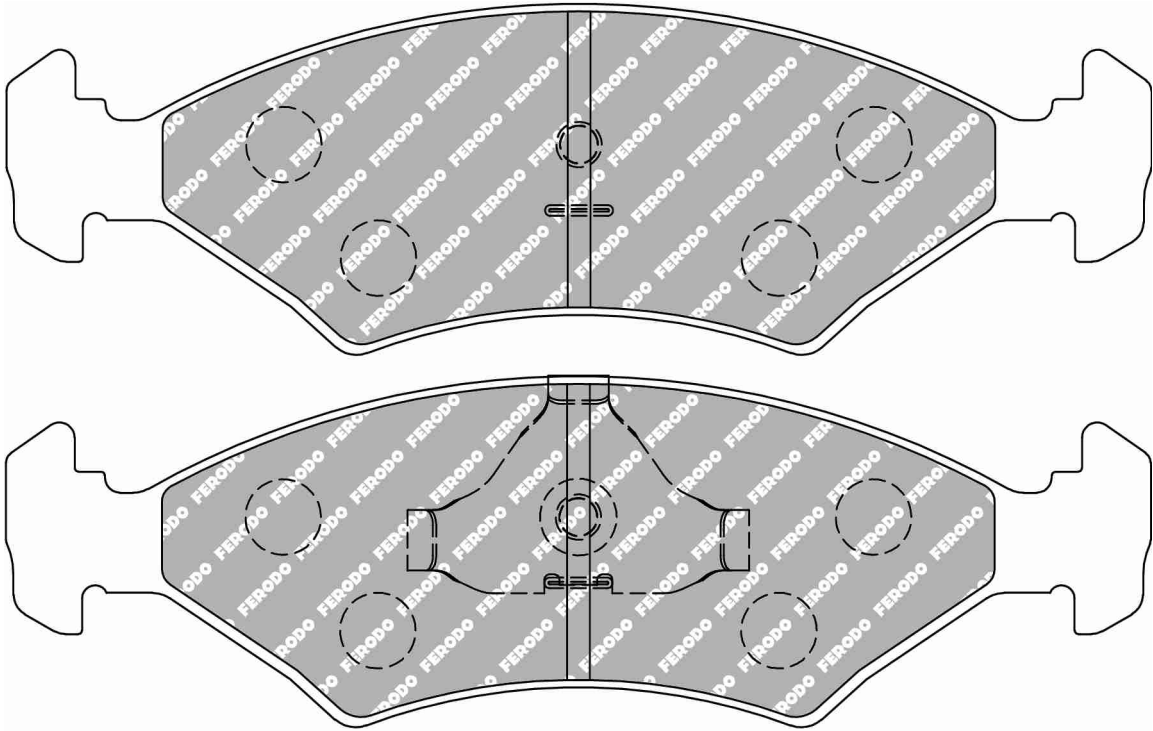

MATERIAL AVAILABILITY

H	C	R	W	WB	Z	ZB
✓		✓			✉	

CROSS REFERENCE

BREMBO	07.8301.03
CL BRAKES	4016
FMSI	D350
MINTEX	MDB1175
PAGID	4823
PFC	0350
WVA	20640-20753 18,60

FCP253

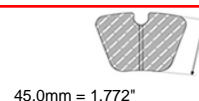
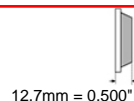

CITROEN Front, PEUGEOT Front

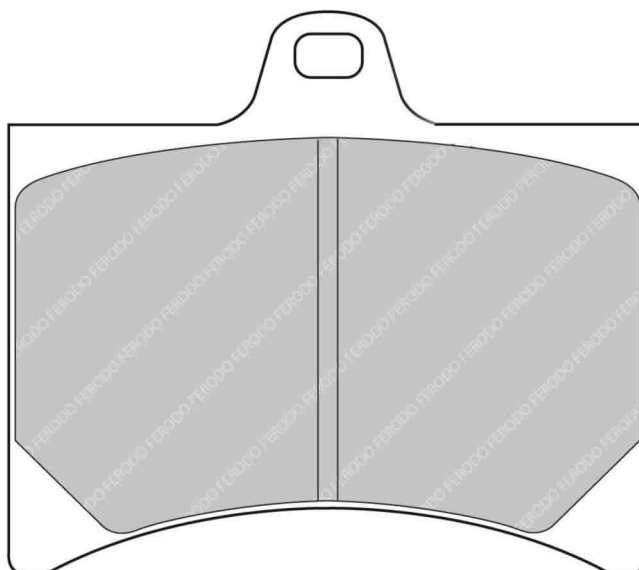

MATERIAL AVAILABILITY						
H	C	R	W	WB	Z	ZB

CROSS REFERENCE	
MINTEX	MDB1155

- Available
- Exhausting
- Out of Range
- Make to order
- In Introduction

FCP256

WVA No: 20629 20,00

FMSI No: D253



158.5mm = 6.240"



58.0mm = 2.283"



19.5mm = 0.768"

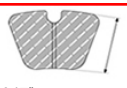

52.0mm = 2.047"

BMW Front, FERRARI Front, MASERATI Front, PORSCHE Front

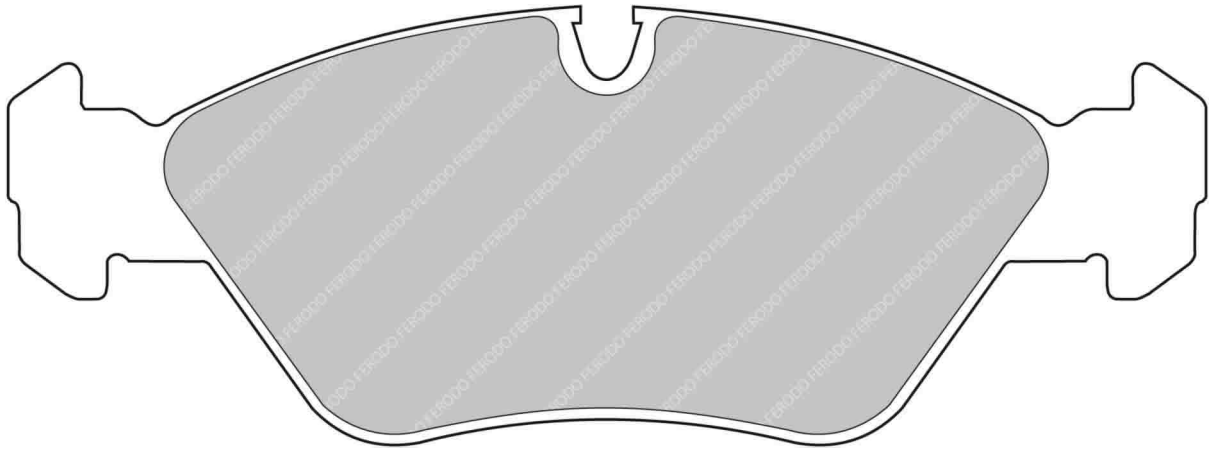

MATERIAL AVAILABILITY

H	C	R	W	WB	Z	ZB
✓		✓				

CROSS REFERENCE

CL BRAKES	4025
FMSI	D253
FMSI	D395
HAWK	HB137 0,69
MINTEX	MDB1230
PAGID	1144
PFC	0253.XX
PFC	0395.XX
WVA	20629 20,00

FCP276

WVA No: 20907 18,00

FMSI No: D298



151.5mm = 5.965"



49.0mm = 1.929"



18.0mm = 0.709"

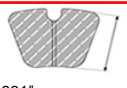

46.5mm = 1.831"

AC Front, FORD Front

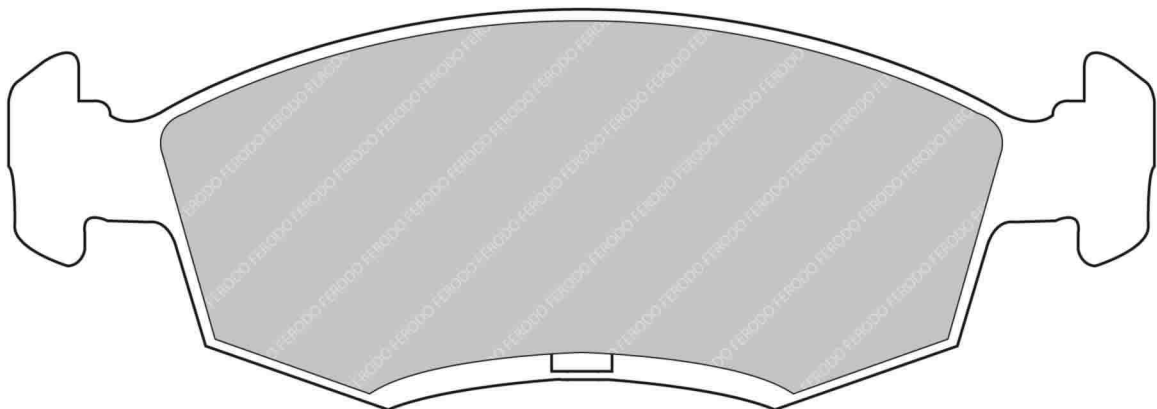

MATERIAL AVAILABILITY

H	C	R	W	WB	Z	ZB
✓		✓				

CROSS REFERENCE

BREMBO	07.8301.04
CL BRAKES	4023
FMSI	D298
MINTEX	MDB1290
WVA	20907 18,00

3012

FERODO

RACING

Updated on 17th Aug 2018

✓ Available ⚠ Exhausting
✗ Out of Range 📦 Make to order
🔧 In Introduction

FCP296

WVA No: 20675 17,00

FMSI No: D279



125.2mm = 4.929"
125.2mm = 4.929"



38.2mm = 1.504"
38.2mm = 1.504"



16.2mm = 0.638"
16.2mm = 0.638"



31.0mm = 1.220"
31.0mm = 1.220"

BMW Rear

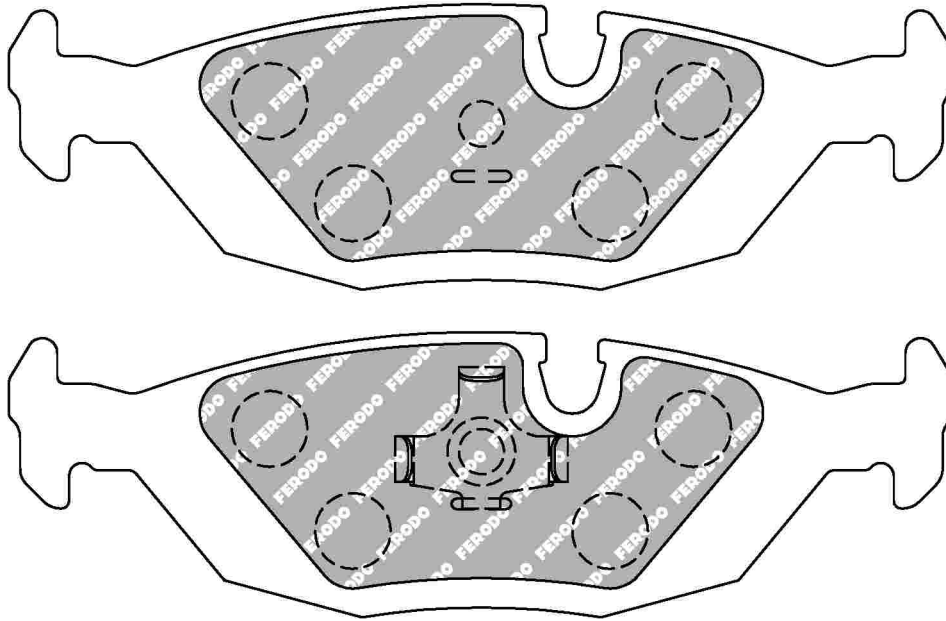

MATERIAL AVAILABILITY

H	C	R	W	WB	Z	ZB
✓		✓	✉			

CROSS REFERENCE

FMSI	D279
HAWK	HB399 0,63
MINTEX	MDB1239
PAGID	1141
WVA	20675 17,00

✓ Available ⚠ Exhausting
 ✗ Out of Range ✉ Make to order
 ⓘ In Introduction

FCP308

WVA No: 20870 15,00

FMSI No: D242

CHEVROLET Front, GEO Front, TOYOTA Front

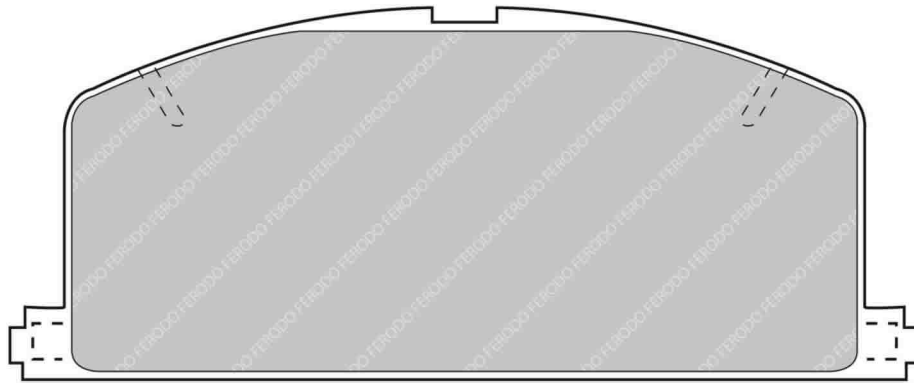
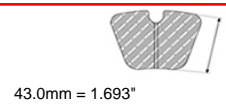
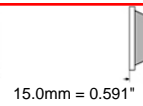
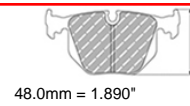
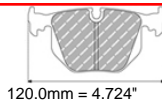

MATERIAL AVAILABILITY						
H	C	R	W	WB	Z	ZB
✓		✓				

CROSS REFERENCE	
FMSI	D242
FMSI	D356
HAWK	HB191 0,59
MINTEX	MDB1251
PFC	0242.XX
PFC	0356.XX
WVA	20870 15,00

FCP342

WVA No: 20053 10,00

FMSI No: D064

RENAULT Rear, ROVER Front

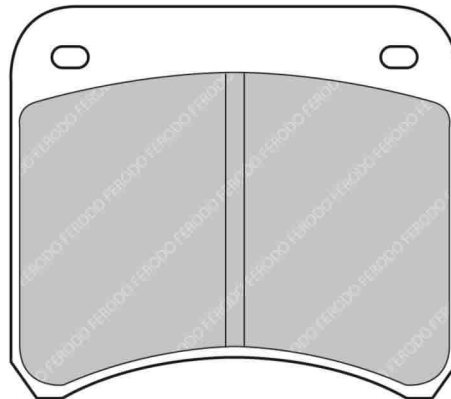
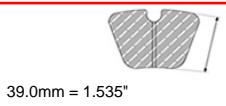
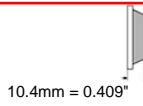
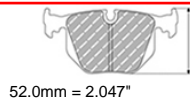
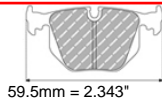

MATERIAL AVAILABILITY						
H	C	R	W	WB	Z	ZB
✓	✓	✓	✗		✓	

CROSS REFERENCE	
AP RACING	CP2195D38
CL BRAKES	5000W38T10
FMSI	D064
MINTEX	MLB19
PAGID	1362
PFC	7719
WVA	20053 10,00

FCP351

WVA No: 20775 18,20

FMSI No: D125

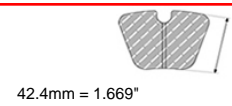
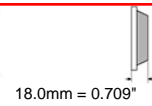
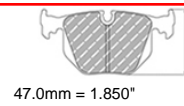
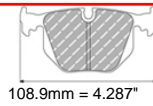

AUTOBIANCHI Front, FIAT Front, INNOCENTI Front, LANCIA Front, SEAT Front

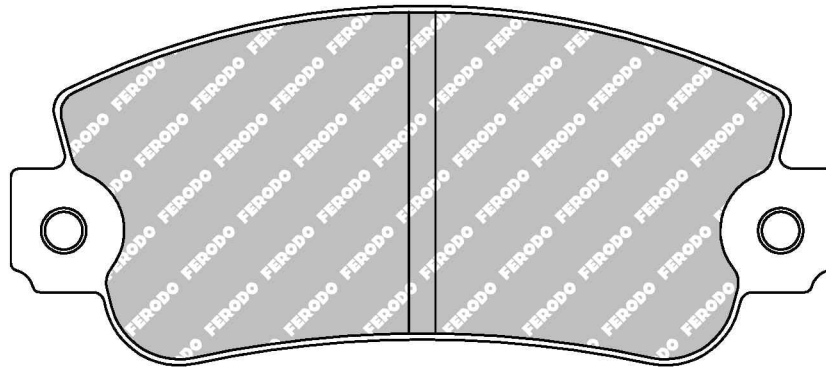

ALSO AVAILABLE		
SHAPE	TH. MM	NOTES
FCP360	12	

CROSS REFERENCE	
FMSI	D125
MINTEX	MDB1218
WVA	20775 18,20

MATERIAL AVAILABILITY						
H	C	R	W	WB	Z	ZB
✓		✓			✓	

FCP360

WVA No: 20841 12,00

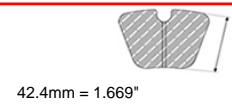
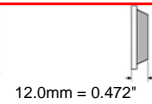
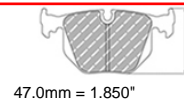
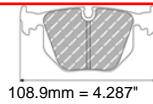

FIAT Rear, LANCIA Rear, RENAULT Rear, RENAULT-ALPINE Rear

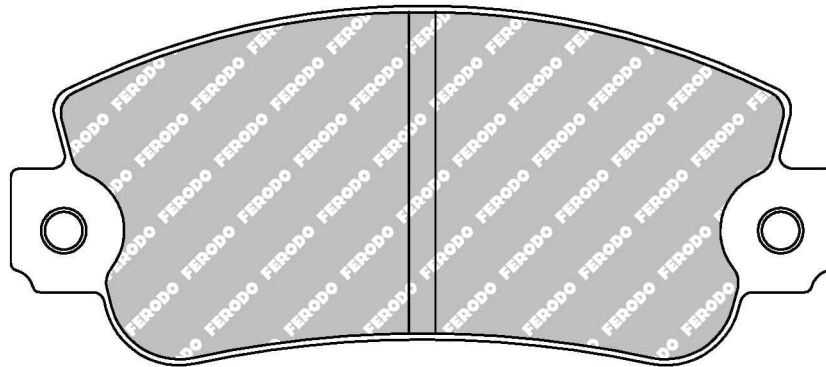

No bevel on backplate

ALSO AVAILABLE		
SHAPE	TH. MM	NOTES
FCP351	18	

CROSS REFERENCE	
BREMBO	07.8301.05
MINTEX	MDB1088
MINTEX	MDB1258
MINTEX	MDB1962
PAGID	1703
WVA	20841 12,00

MATERIAL AVAILABILITY						
H	C	R	W	WB	Z	ZB
✓						

✓ Available ⚠ Exhausting
 ✗ Out of Range 📦 Make to order
 📅 In Introduction

FCP370

WVA No: 20833 17,00

FMSI No: D147



104.7mm = 4.122"



67.0mm = 2.638"



17.3mm = 0.681"

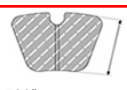

45.7mm = 1.799"

ABARTH Front, ALFA ROMEO Front, AUDI Front, AUTOBIANCHI Front, FIAT Front, INNOCENTI Front, LANCIA Front, VOLVO Front

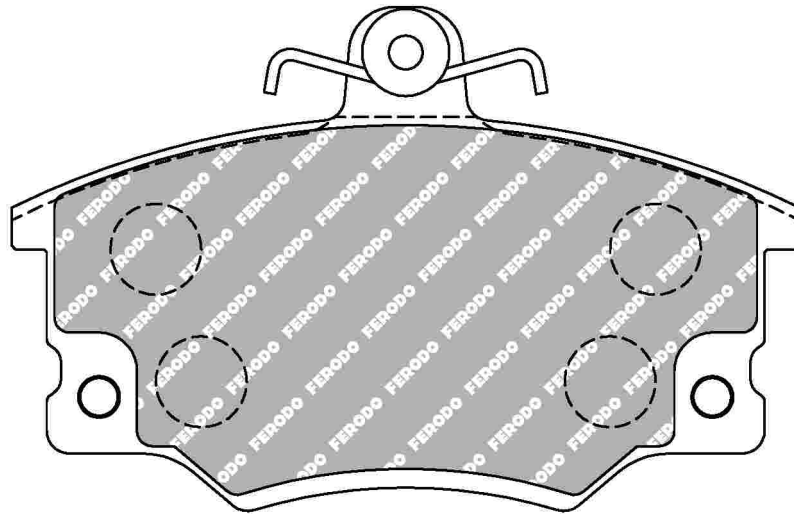

MATERIAL AVAILABILITY						
H	C	R	W	WB	Z	ZB
✓	✗	✓	✗		✓	

CROSS REFERENCE	
BREMBO	07.8301.06
CL BRAKES	4028
FMSI	D147
MINTEX	MDB1240
MINTEX	MDB1257
MINTEX	MDB2758
WVA	20833 17,00

FCP372

WVA No: 20328 12,90

FMSI No: D283



107.9mm = 4.248"



39.6mm = 1.559"



13.1mm = 0.516"

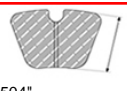

38.2mm = 1.504"

MAZDA Rear



MATERIAL AVAILABILITY						
H	C	R	W	WB	Z	ZB
✓		✗	✗			

CROSS REFERENCE	
FMSI	D283
HAWK	HB158 0,515
MINTEX	MDB2309
WVA	20328 12,90

FCP385

WVA No: 20889 17,30

FMSI No: D307



138.0mm = 5.433"



51.4mm = 2.024"



17.0mm = 0.669"

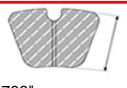

45.3mm = 1.783"

SEAT Front, VOLKSWAGEN Front

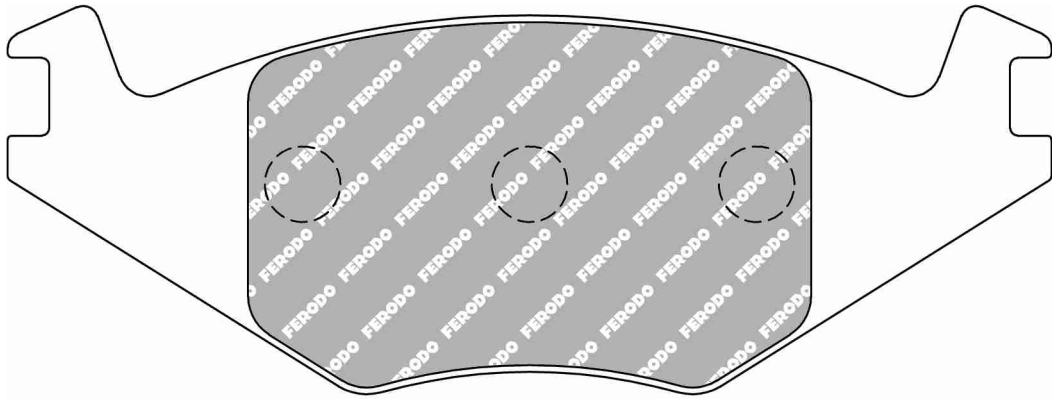

MATERIAL AVAILABILITY						
H	C	R	W	WB	Z	ZB

CROSS REFERENCE	
BREMBO	07.8301.07
CL BRAKES	4021
FMSI	D307
MINTEX	MDB1273
MINTEX	MDB1436
PAGID	2130
WVA	20889 17,30

- Available
- Exhausting
- Out of Range
- Make to order
- In Introduction

FCP392

WVA No: 20887 15,30

FMSI No: D280



138.0mm = 5.433"
138.0mm = 5.433"



49.3mm = 1.941"
51.4mm = 2.024"



15.3mm = 0.602"
15.3mm = 0.602"

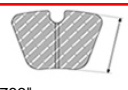

45.3mm = 1.783"
45.3mm = 1.783"

SEAT Front, VOLKSWAGEN Front

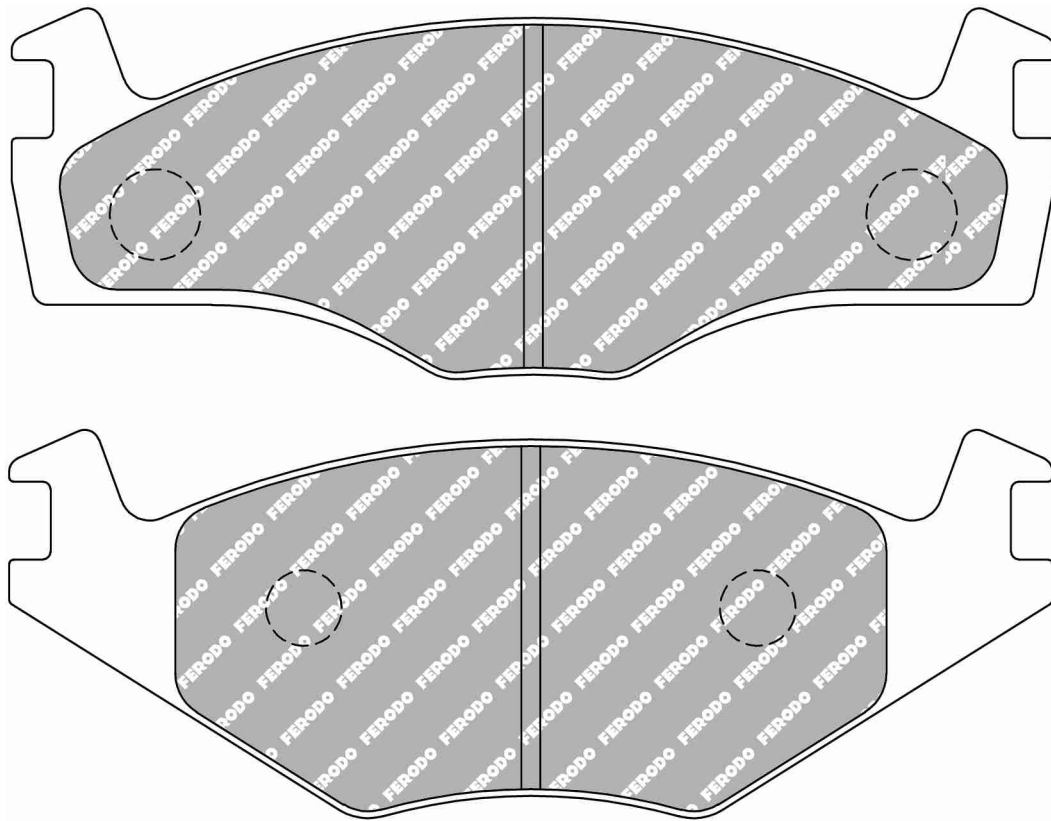

ALSO AVAILABLE

SHAPE	TH. MM	NOTES
FCP419	19.7	

MATERIAL AVAILABILITY

H	C	R	W	WB	Z	ZB
✓		✓	✉			

CROSS REFERENCE

BREMBO	07.8301.08
BREMBO	07.8301.12
BREMBO	07.8301.49
CL BRAKES	4021
FMSI	D280
FMSI	D569
HAWK	HB189 0,55
MINTEX	MDB1266
PAGID	4011
PFC	0280.XX
WVA	20887 15,30

FCP393

WVA No: 20905 18,00

FMSI No: D371



105.0mm = 4.134"



54.0mm = 2.126"



18.0mm = 0.709"



42.3mm = 1.665"

CITROEN Front, PEUGEOT Front, RENAULT Front, RENAULT-ALPINE Rear

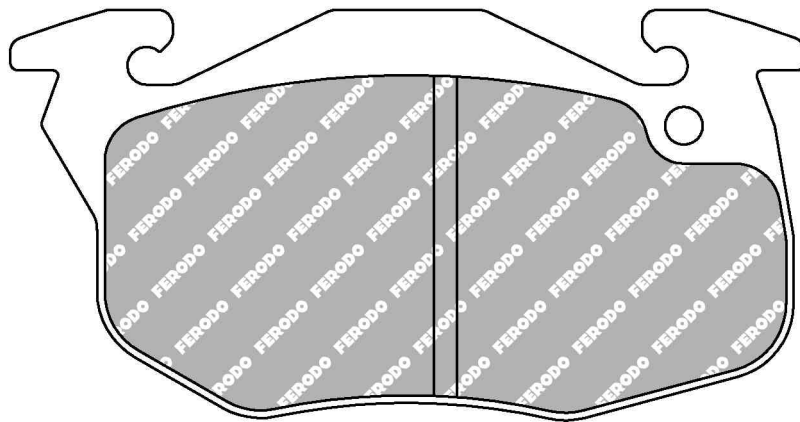
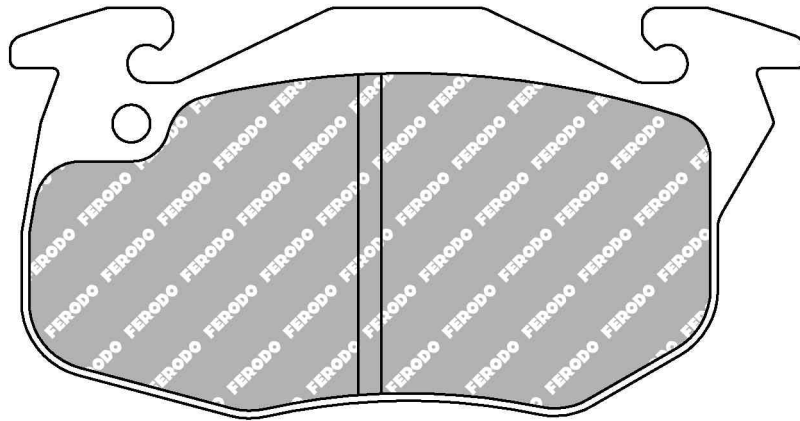

Set = 1 left / 1 right

MATERIAL AVAILABILITY						
H	C	R	W	WB	Z	ZB
✓		✓				

CROSS REFERENCE	
BREMBO	07.8301.09
CL BRAKES	4007
FMSI	D371
MINTEX	MDB1291
PAGID	1609
WVA	20905 18,00

✓ Available ⚠ Exhausting
 ✗ Out of Range 📦 Make to order
 ⓘ In Introduction

FCP399

WVA No: 21088 17,00

FMSI No: D163



89.7mm = 3.531"



68.0mm = 2.677"



17.0mm = 0.669"

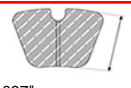

53.0mm = 2.087"

BMW Front, FORD Front, GINETTA Front / Rear, LAMBORGHINI Front, MASERATI Front

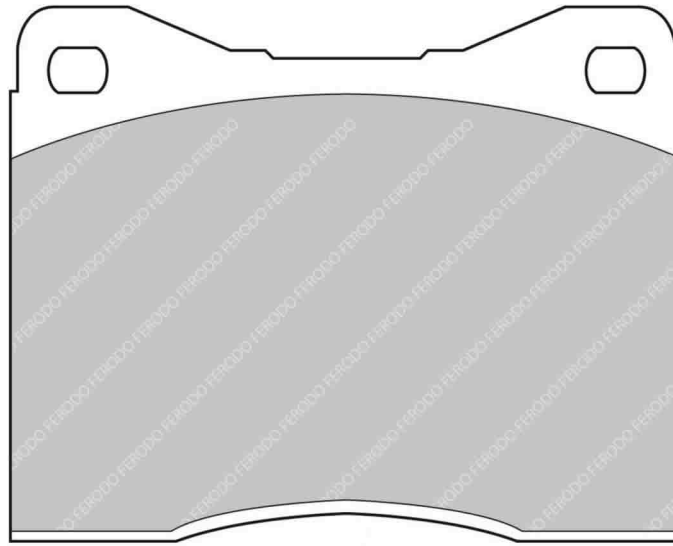

MATERIAL AVAILABILITY						
H	C	R	W	WB	Z	ZB
✓		✓				

CROSS REFERENCE	
CL BRAKES	4014
EBC	DP753
FMSI	D163
HAWK	HB206 0,565
MINTEX	MDB1323
PFC	0163.XX
WVA	21088 17,00

FCP406

WVA No: 21388 18,50



129.9mm = 5.114"



55.0mm = 2.165"



17.7mm = 0.697"



51.2mm = 2.016"

PEUGEOT Front, RENAULT Front, RENAULT-ALPINE Front

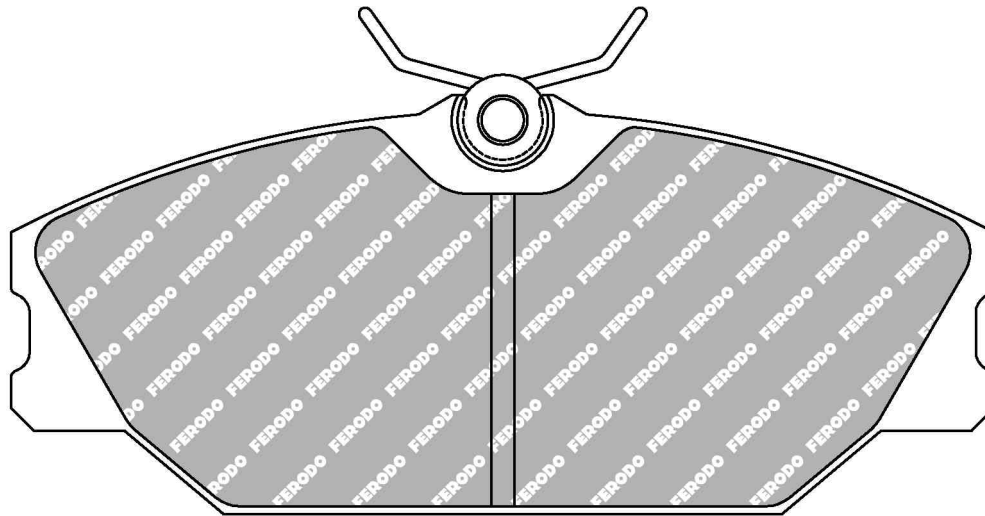

MATERIAL AVAILABILITY						
H	C	R	W	WB	Z	ZB
✓		✓			✓	

CROSS REFERENCE	
BREMBO	07.8301.10
MINTEX	MDB1316
WVA	21388 18,50

FCP408

WVA No: 21079 13,75

FMSI No: D382



89.9mm = 3.539"

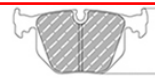

54.0mm = 2.126"



12.5mm = 0.492"



34.5mm = 1.358"

CATERHAM Rear, FORD Rear, GINETTA Rear, MERCURY Front, TVR Rear

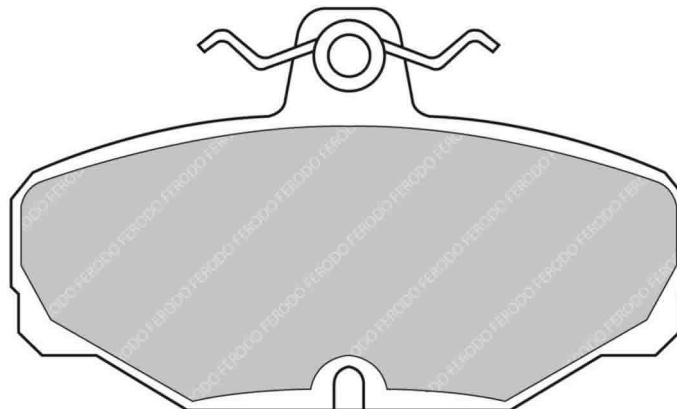

MATERIAL AVAILABILITY						
H	C	R	W	WB	Z	ZB
✓		✓			✉	

CROSS REFERENCE	
CL BRAKES	4035
EBC	DP617
FMSI	D382
MINTEX	MDB1286
MINTEX	MDB1639
PAGID	1163
PFC	0382
WVA	21079 13,75

✓ Available ⚠ Exhausting
 ✗ Out of Range ✉ Make to order
 ⓘ In Introduction

FCP409

WVA No: 21103 14,50



88.0mm = 3.465"



46.0mm = 1.811"



14.4mm = 0.567"



41.7mm = 1.642"

ALFA ROMEO Rear, AUDI Rear, FIAT Rear, LANCIA Rear

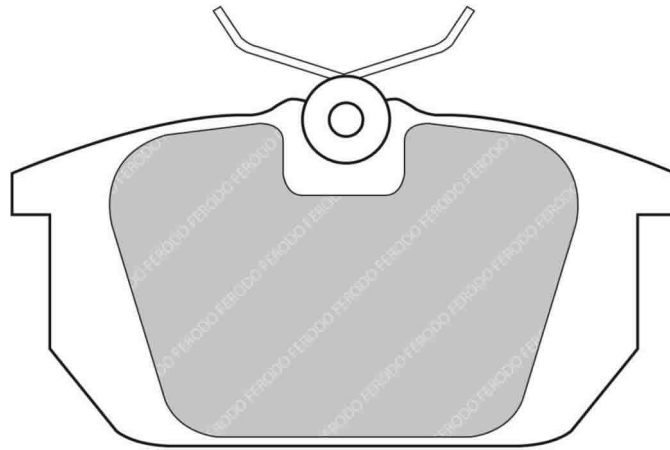

MATERIAL AVAILABILITY						
H	C	R	W	WB	Z	ZB
✓		✓				

CROSS REFERENCE	
BREMBO	07.8301.11
MINTEX	MDB1309
WVA	21103 14,50

FCP415

WVA No: 20941 19,30

FMSI No: D423



108.3mm = 4.264"



60.0mm = 2.362"



19.3mm = 0.760"



52.0mm = 2.047"

MERCEDES Front

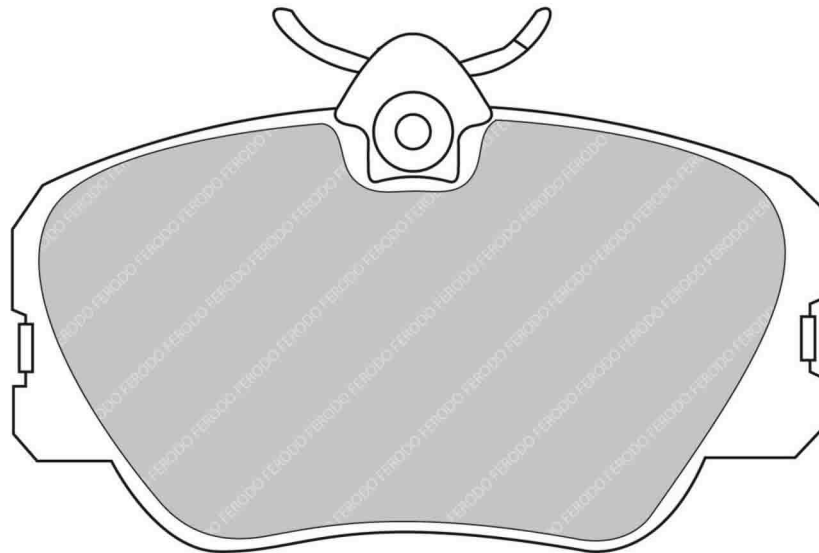

MATERIAL AVAILABILITY						
H	C	R	W	WB	Z	ZB
✓		✓				

CROSS REFERENCE	
FMSI	D423
MINTEX	MDB1312
MINTEX	MDB1437
PAGID	1190
WVA	20941 19,30

FCP419

WVA No: 20887 19,70



138.0mm = 5.433"
138.0mm = 5.433"



49.3mm = 1.941"
51.4mm = 2.024"



19.7mm = 0.776"
19.7mm = 0.776"

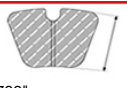

45.3mm = 1.783"
45.3mm = 1.783"

SEAT Front, VOLKSWAGEN Front

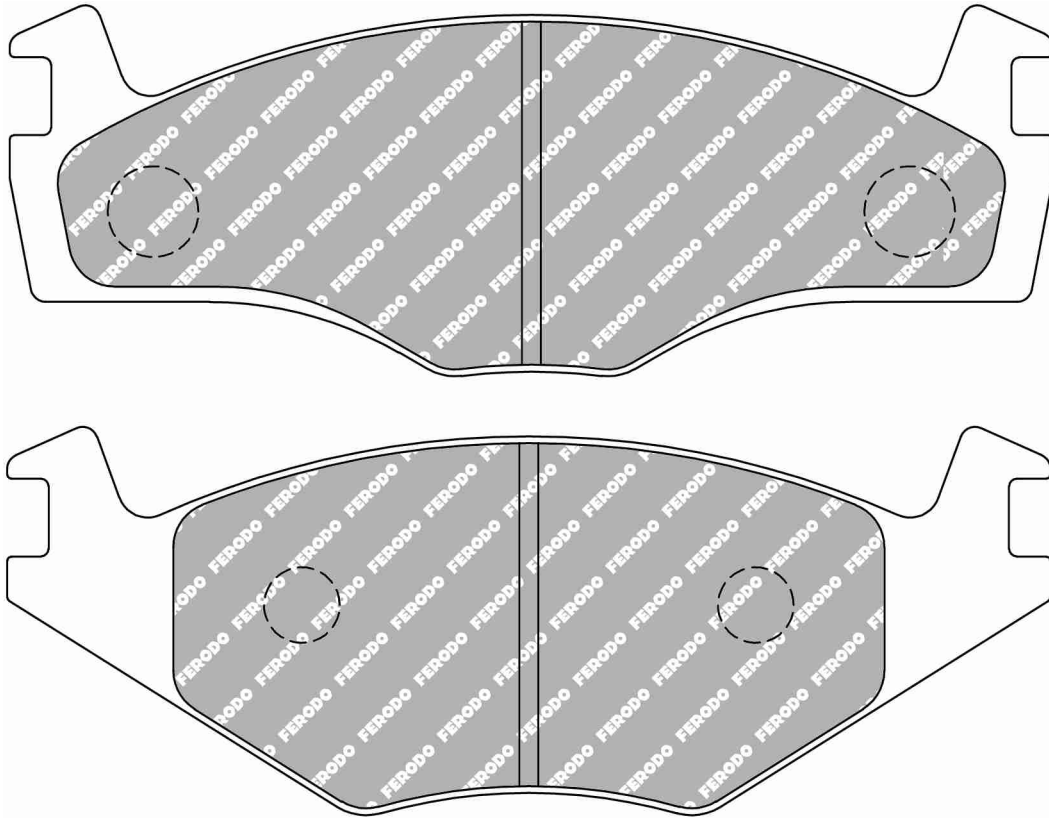

ALSO AVAILABLE

SHAPE	TH. MM	NOTES
FCP392	15.3	

MATERIAL AVAILABILITY

H	C	R	W	WB	Z	ZB
✓						

CROSS REFERENCE

MINTEX	CVP020
MINTEX	CVP020K
MINTEX	MDB1267
WVA	20887 19,70

✓ Available ⚠ Exhausting
 ✗ Out of Range 📦 Make to order
 📌 In Introduction

FERODO
RACING
 Updated on 17th Aug 2018

3023

FCP434

WVA No: 20923 17,50

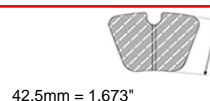
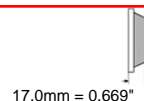

CITROEN Front, PEUGEOT Front

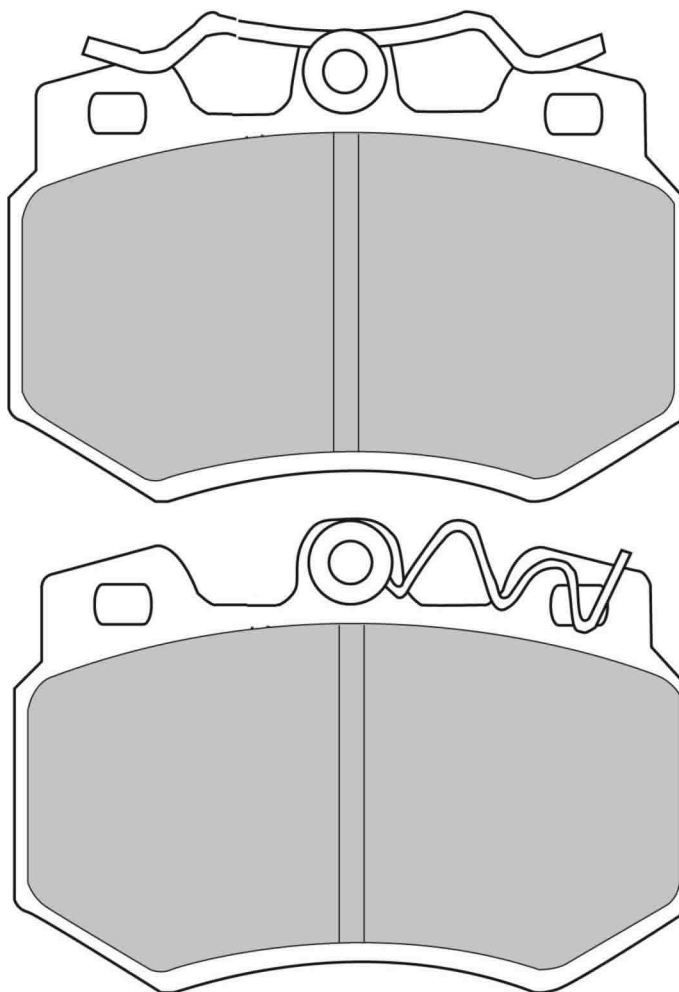

MATERIAL AVAILABILITY						
H	C	R	W	WB	Z	ZB
✓		✉				

CROSS REFERENCE	
BREMBO	07.8301.13
MINTEX	MDB1327
WVA	20923 17,50

FCP441

WVA No: 21098 16,00



100.0mm = 3.937"



53.0mm = 2.087"



16.0mm = 0.630"



41.0mm = 1.614"

ALFA ROMEO Front, NISSAN Front

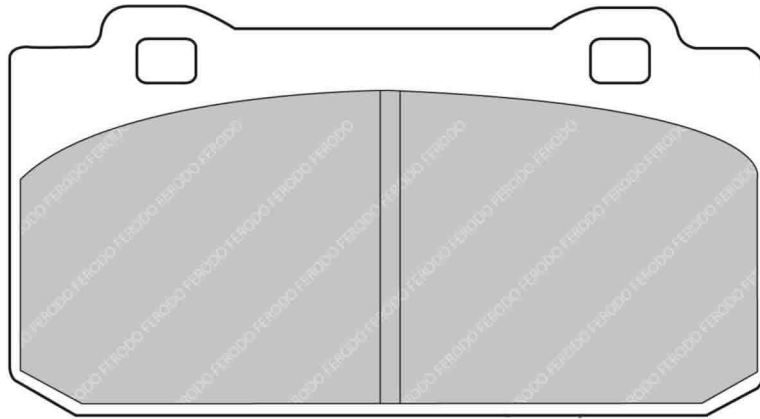

MATERIAL AVAILABILITY						
H	C	R	W	WB	Z	ZB
	✗	✓				

CROSS REFERENCE	
MINTEX	MDB1357
WVA	21098 16,00

FCP448

WVA No: 20323 16,50

FMSI No: D0109



76.8mm = 3.024"



62.0mm = 2.441"



15.0mm = 0.591"



45.0mm = 1.772"

ALFA ROMEO Front, OPEL Front

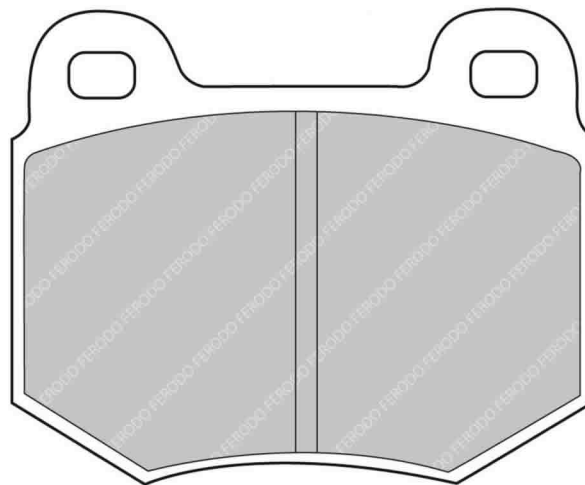

MATERIAL AVAILABILITY						
H	C	R	W	WB	Z	ZB
✓		✓				

CROSS REFERENCE	
FMSI	D0109
HAWK	HB180 0,64
MINTEX	MDB1361
MINTEX	MTX1890
PFC	0174.XX
WVA	20323 16,50

FCP451

WVA No: 20877 17,50

FMSI No: D345

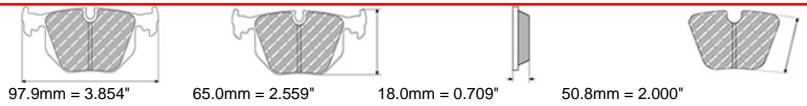

FERRARI Front / Rear, MASERATI Rear, PORSCHE Front / Rear

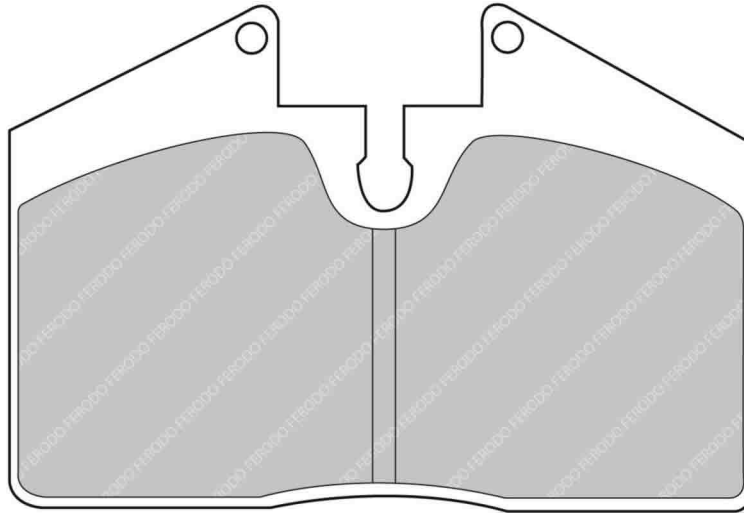

ALSO AVAILABLE		
SHAPE	TH. MM	NOTES
FRP3069	16	

MATERIAL AVAILABILITY						
H	C	R	W	WB	Z	ZB
✓		✓	✗		✓	

CROSS REFERENCE	
ALCON	PNF4436X508.4
CL BRAKES	4002
FMSI	D345
FMSI	D608
HAWK	HB170 0,65
MINTEX	MDB1456
PAGID	1203
PFC	0345.XX
WVA	20877 17,50

FCP461

WVA No: 20561 15,00



SKODA Front, TATRA Rear, WARTBURG Front

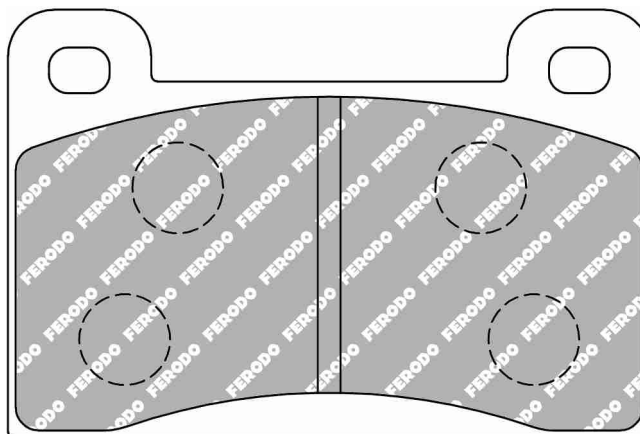

MATERIAL AVAILABILITY						
H	C	R	W	WB	Z	ZB
✓		✓				

CROSS REFERENCE	
MINTEX	MDB1165
PAGID	8067
WVA	20561 15,00

3026

FCP472

WVA No: 21312 12,80

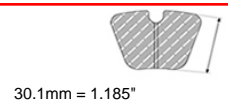
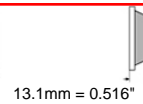
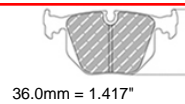
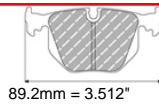

HONDA Rear, MG Rear, ROVER Rear

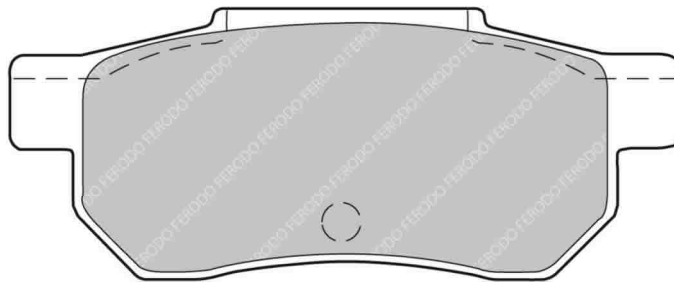

MATERIAL AVAILABILITY						
H	C	R	W	WB	Z	ZB
✓						

CROSS REFERENCE	
MINTEX	MDB1360
MINTEX	MDB2191
WVA	21312 12,80

FCP483

WVA No: 20878 14,80

FMSI No: D331

MAZDA Front

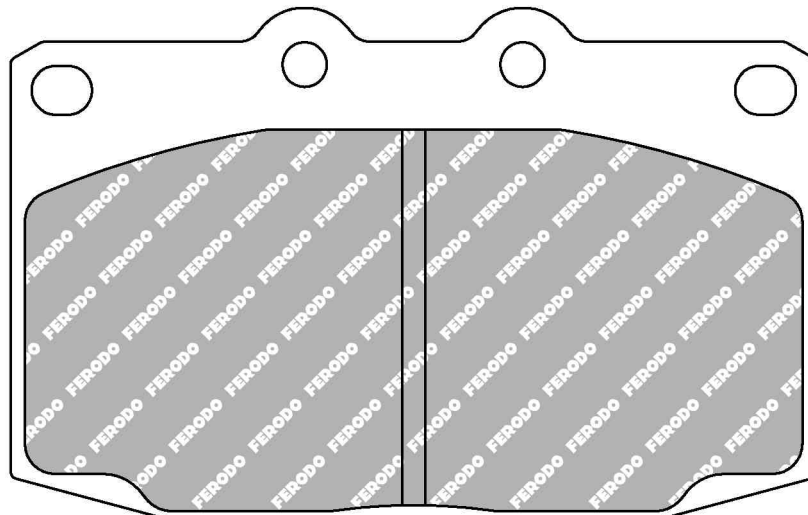
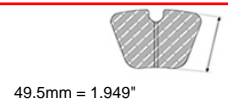
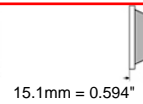
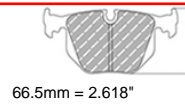
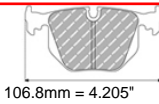

MATERIAL AVAILABILITY						
H	C	R	W	WB	Z	ZB
✓		✓			✉	

CROSS REFERENCE	
FMSI	D331
HAWK	HB155 0,58
MINTEX	MDB1351
MINTEX	MDB1935
PFC	0463
WVA	20878 14,80

FCP484

WVA No: 21121 13,80



85.5mm = 3.366"



45.0mm = 1.772"



14.2mm = 0.559"



39.6mm = 1.559"

NISSAN Rear

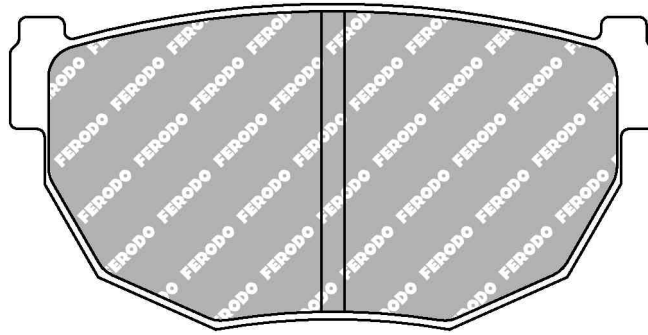

MATERIAL AVAILABILITY						
H	C	R	W	WB	Z	ZB
✓	✗	✗				

CROSS REFERENCE	
MINTEX	MDB1295
PFC	0272
WVA	21121 13,80

FCP487

WVA No: 21277 15,00

FMSI No: D319



91.7mm = 3.610"



64.5mm = 2.539"



15.0mm = 0.591"



42.8mm = 1.685"

MAZDA Front, SAO Front

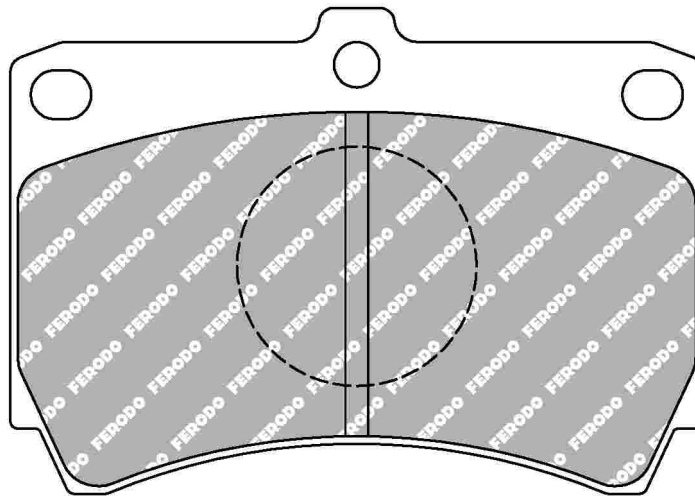

Set supplied without clip

MATERIAL AVAILABILITY						
H	C	R	W	WB	Z	ZB
✓		✉				

CROSS REFERENCE	
FMSI	D319
FMSI	D473
HAWK	HB246 0,567
MINTEX	MDB1348
PFC	0473.XX
WVA	21277 15,00

FCP519

WVA No: 21193 18,00



151.5mm = 5.965"



49.0mm = 1.929"



18.0mm = 0.709"



44.1mm = 1.736"

FIAT Front, FIAT AUTO POLAND Front, INNOCENTI Front

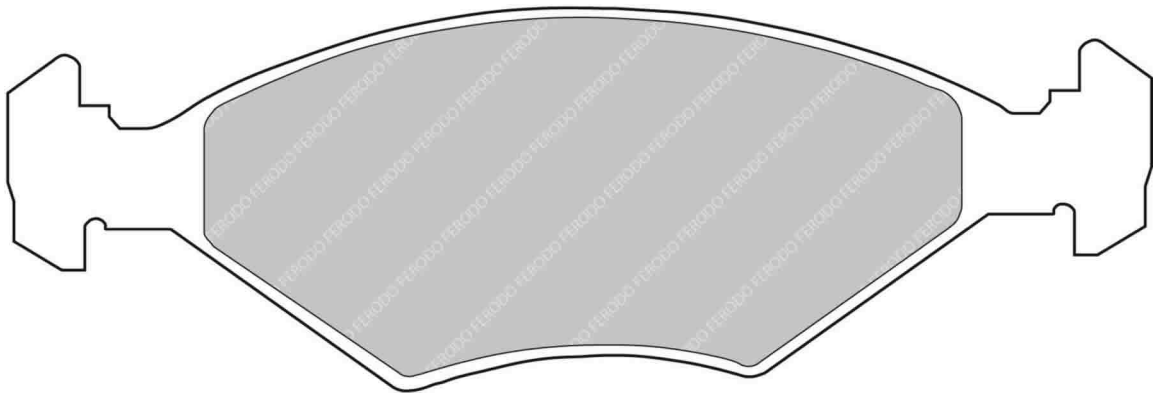

MATERIAL AVAILABILITY

H	C	R	W	WB	Z	ZB

CROSS REFERENCE

BREMBO	07.8301.14
MINTEX	MDB1513
WVA	21193 18,00

FCP524

WVA No: 21100 17,00



90.0mm = 3.543"



65.0mm = 2.559"



17.0mm = 0.669"



46.3mm = 1.823"

FIAT Front, LANCIA Front, YUGO Front

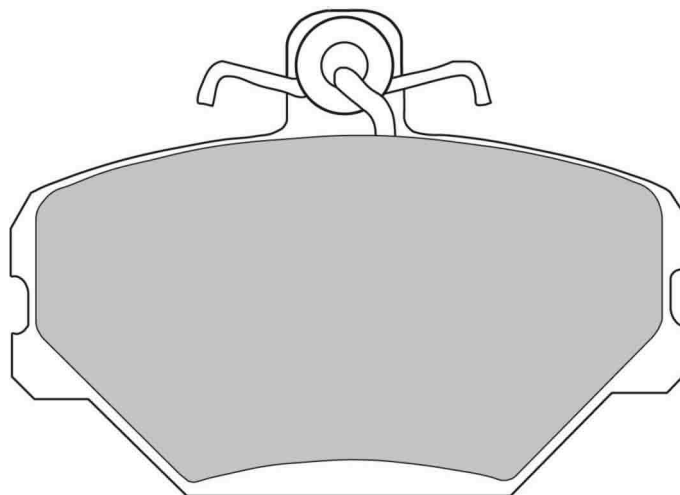

MATERIAL AVAILABILITY

H	C	R	W	WB	Z	ZB

CROSS REFERENCE

BREMBO	07.8301.15
MINTEX	MDB1384
MINTEX	MDB1606
WVA	21100 17,00

Available
 Out of Range
 In Introduction
 Exhausting
 Make to order

FERODO
RACING
 Updated on 17th Aug 2018

3029

FCP527

WVA No: 21170 17,30



104.5mm = 4.114"



60.0mm = 2.362"



17.7mm = 0.697"



36.0mm = 1.417"

LADA Front

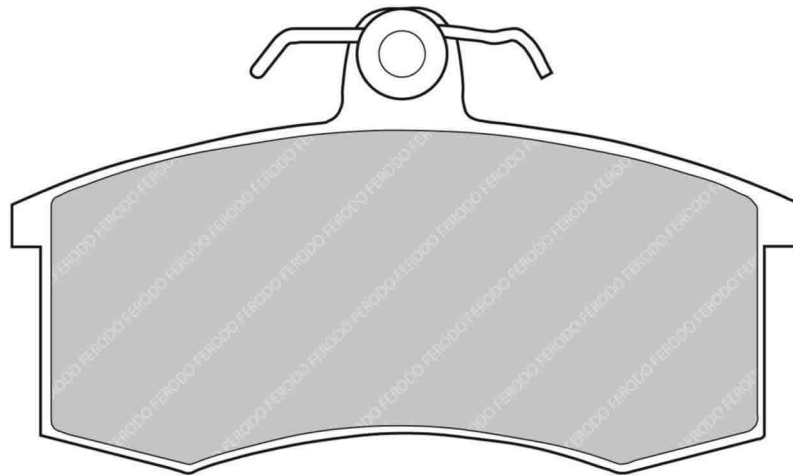

MATERIAL AVAILABILITY						
H	C	R	W	WB	Z	ZB
✓		✓				

CROSS REFERENCE	
MINTEX	MDB1353
WVA	21170 17,30

FCP535

WVA No: 21179 16,80



72.0mm = 2.835"



61.0mm = 2.402"



16.5mm = 0.650"



39.5mm = 1.555"

CITROEN Front, PEUGEOT Front

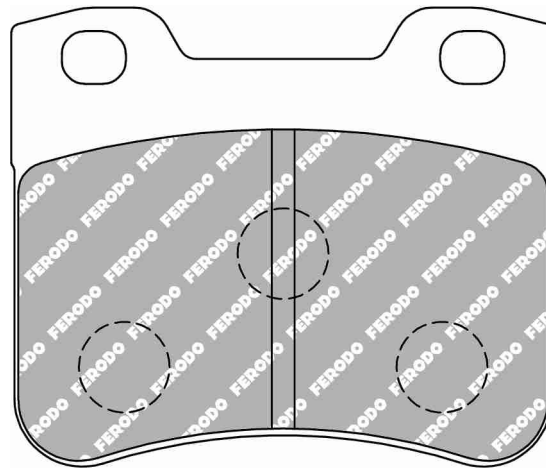

MATERIAL AVAILABILITY						
H	C	R	W	WB	Z	ZB
✓	✗	✓				

CROSS REFERENCE	
BREMBO	07.8301.16
MINTEX	MDB1483
WVA	21179 16,80

FCP541

WVA No: 20961 15,20

FMSI No: D306

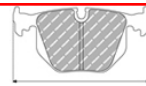

87.4mm = 3.441"

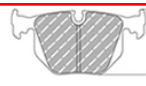

52.9mm = 2.083"



15.0mm = 0.591"



40.8mm = 1.606"

AUDI Rear, CITROEN Rear, FERRARI Front, FORD Rear, HONDA Rear, MERCEDES Rear, PEUGEOT Rear, PORSCHE Rear, RENAULT Rear, SEAT Rear, SKODA Rear, VOLKSWAGEN Rear

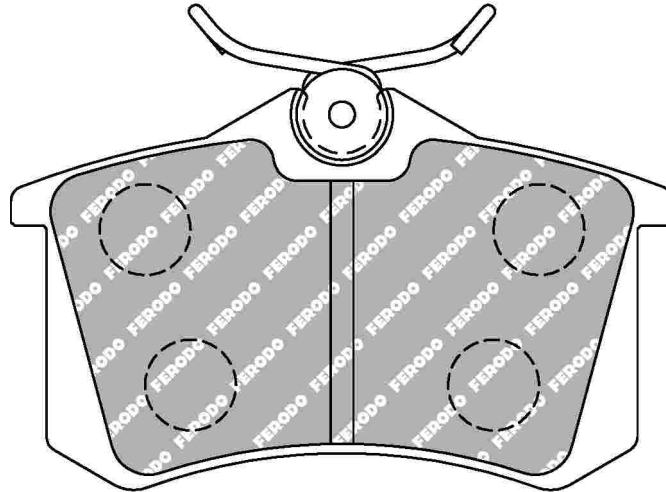

ALSO AVAILABLE		
SHAPE	TH. MM	NOTES
FCP1491	16	

MATERIAL AVAILABILITY						
H	C	R	W	WB	Z	ZB
✓		✓	✉		✉	

CROSS REFERENCE	
BREMBO	07.8301.17
CL BRAKES	4038
EBC	DP680
FMSI	D306
FMSI	D340
FMSI	D851
HAWK	HB271 0,635
HAWK	HB364 0,642
MINTEX	MDB1382
OE AUDI	8E0698451L
OE Renault	440600678R
PAGID	1158
WVA	20961 15,20

✓ Available ⚠ Exhausting
 ✗ Out of Range ✉ Make to order
 ⓘ In Introduction

FCP546

WVA No: 21165 16,50

FMSI No: D454

ALFA ROMEO Front



95.0mm = 3.740"



49.0mm = 1.929"



16.5mm = 0.650"



43.0mm = 1.693"

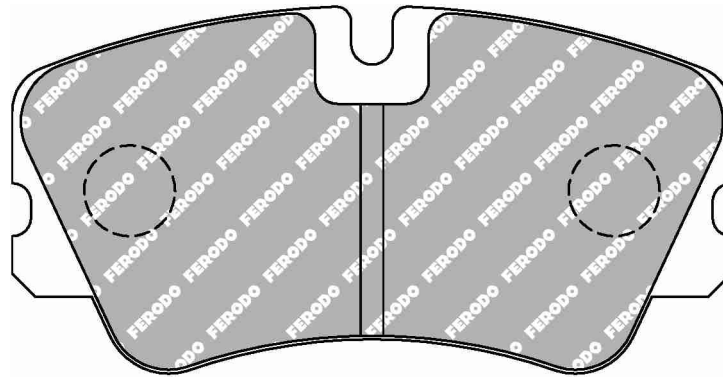

MATERIAL AVAILABILITY						
H	C	R	W	WB	Z	ZB
✓		✓				

CROSS REFERENCE	
FMSI	D454
MINTEX	MDB1403
PAGID	1760
WVA	21165 16,50

FCP558

WVA No: 20973 11,00

FMSI No: D516

CITROEN Rear, PEUGEOT Rear, RENAULT Rear



105.2mm = 4.142"



54.8mm = 2.157"



11.0mm = 0.433"



42.0mm = 1.654"

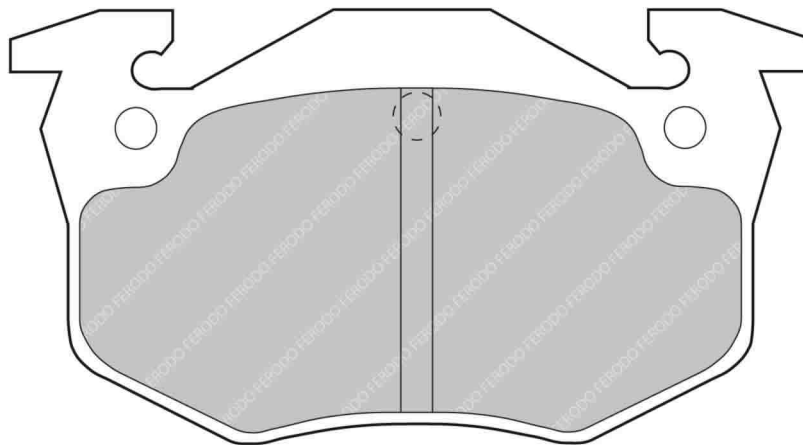

ALSO AVAILABLE		
SHAPE	TH. MM	NOTES
FCP881	15	

MATERIAL AVAILABILITY						
H	C	R	W	WB	Z	ZB
✓	✗	✓				

CROSS REFERENCE	
ALCON	PNF0084X261.4
ALCON	PNF0084X317.4
CL BRAKES	4034
FMSI	D516
MINTEX	MDB1339
MINTEX	MDB2555
MINTEX	MDB2868
PAGID	1610
WVA	20973 11,00

FCP560

WVA No: 20953 17,50

FMSI No: D372



131.8mm = 5.189"



71.0mm = 2.795"



18.0mm = 0.709"

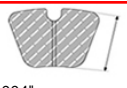

50.9mm = 2.004"

AUDI Front, PORSCHE Front / Rear

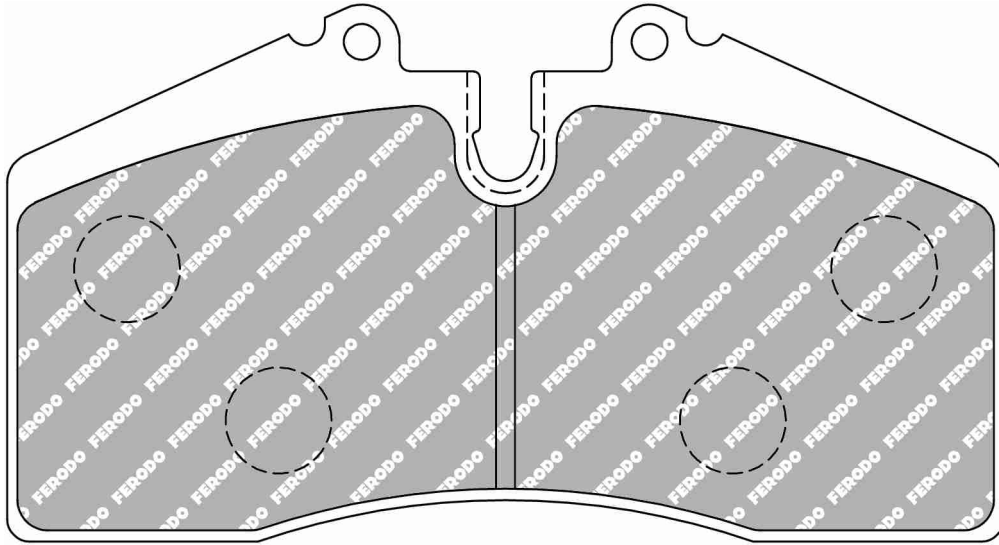

MATERIAL AVAILABILITY						
H	C	R	W	WB	Z	ZB
✓		✓	✉			

CROSS REFERENCE	
CL BRAKES	4001
FMSI	D372
FMSI	D447
FMSI	D609
HAWK	HB141 0,65
MINTEX	MDB1457
PAGID	1204
PFC	0447
WVA	20953 17,50

✓ Available ⚠ Exhausting
 ✗ Out of Range ✉ Make to order
 📌 In Introduction

FCP565

WVA No: 21074 19,00

FMSI No: D590



130.0mm = 5.118"



59.0mm = 2.323"



19.1mm = 0.752"

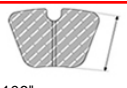

53.5mm = 2.106"

ALFA ROMEO Front, CITROEN Front, FIAT Front, LANCIA Front, PEUGEOT Front, RENAULT Front, RENAULT-ALPINE Front

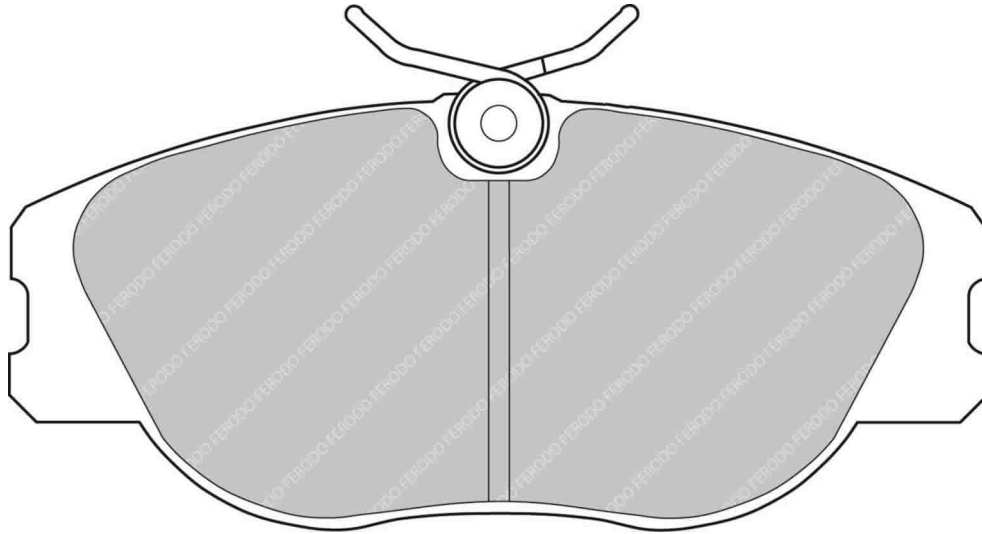

MATERIAL AVAILABILITY

H	C	R	W	WB	Z	ZB
✓		✓	✓			

CROSS REFERENCE

BREMBO	07.8301.18
CL BRAKES	4027
FMSI	D590
MINTEX	MDB1391
MINTEX	MDB1518
PAGID	1702
PFC	0590
WVA	21074 19,00

FCP578

WVA No: 20995 17,30

FMSI No: D396



123.3mm = 4.854"



45.0mm = 1.772"



15.9mm = 0.626"

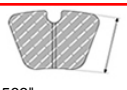

39.7mm = 1.563"

BMW Rear, JAGUAR Rear

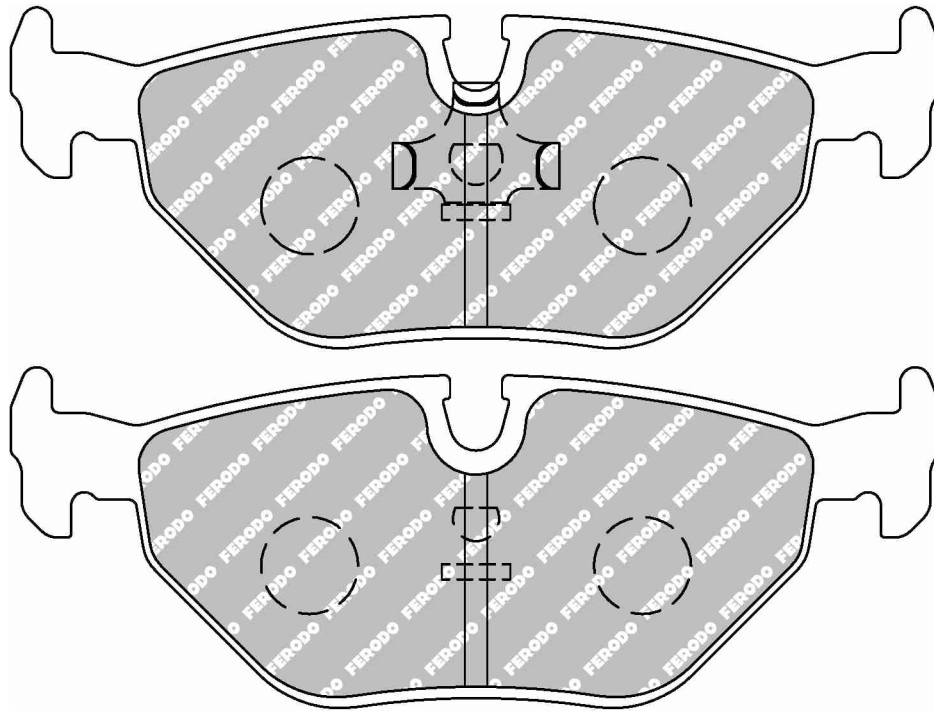

MATERIAL AVAILABILITY

H	C	R	W	WB	Z	ZB
✓		✓				

CROSS REFERENCE

FMSI	D396
HAWK	HB227 0,63
MINTEX	MDB1369
PAGID	1285
PFC	0396.XX
WVA	20995 17,30

✓ Available ⚠ Exhausting
 ✗ Out of Range Make to order
 ⓘ In Introduction

FCP584

WVA No: 21190 17,50

FMSI No: D403

DAEWOO Front, OPEL Front, VAUXHALL Front

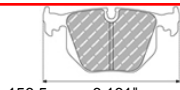

156.5mm = 6.161"



52.6mm = 2.071"



17.5mm = 0.689"



45.2mm = 1.780"

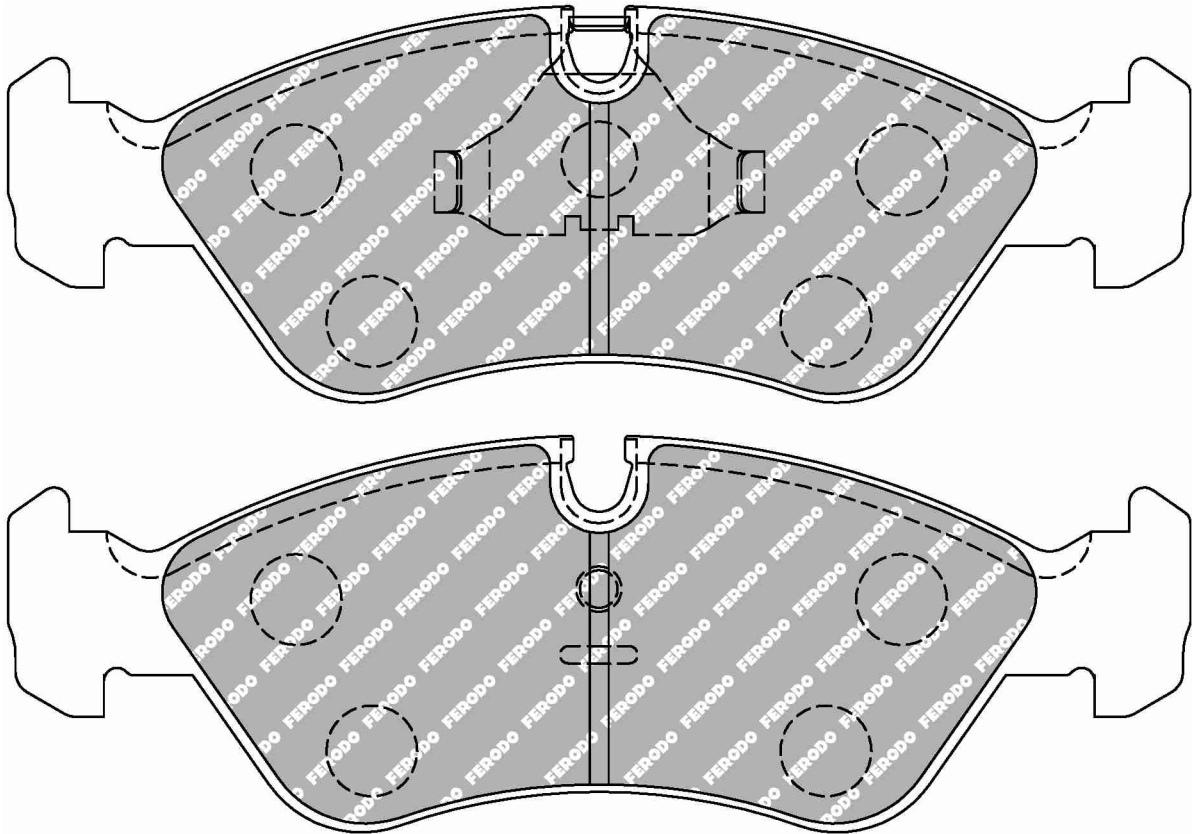

MATERIAL AVAILABILITY						
H	C	R	W	WB	Z	ZB
✓		✓				

CROSS REFERENCE	
BREMBO	07.8301.19
CL BRAKES	4036
FMSI	D403
MINTEX	MDB1386
PAGID	1288
WVA	21190 17,50
WVA	21201-21190 17,50

FCP586

WVA No: 21140 15,70

FMSI No: D427



61.8mm = 2.433"



58.0mm = 2.283"



15.5mm = 0.610"

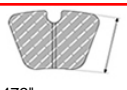

37.4mm = 1.472"

OPEL Rear, SAAB Rear, VAUXHALL Rear

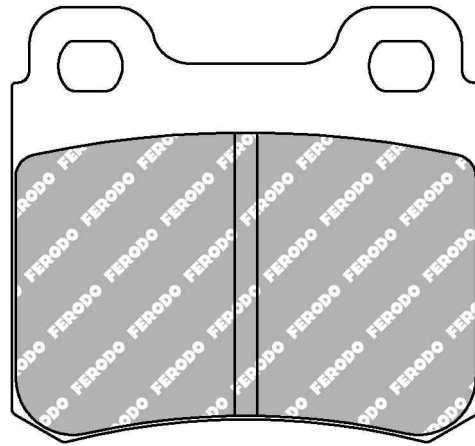

MATERIAL AVAILABILITY						
H	C	R	W	WB	Z	ZB
✓		✓				

CROSS REFERENCE	
CL BRAKES	4037
FMSI	D427
MINTEX	MDB1385
PAGID	1177
PAGID	1177
WVA	21140 15,70

✓ Available ⚠ Exhausting
 ✗ Out of Range 📦 Make to order
 📅 In Introduction

FCP590

WVA No: 20676 19,50 - 21624&21625 19,50

FMSI No: D555

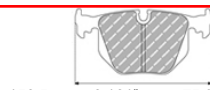

156.5mm = 6.161"

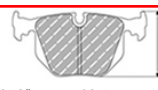

75.0mm = 2.953"



19.5mm = 0.768"

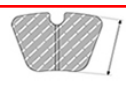

61.0mm = 2.402"

AUDI Front, FORD Front, SEAT Front, SKODA Front, VOLKSWAGEN Front

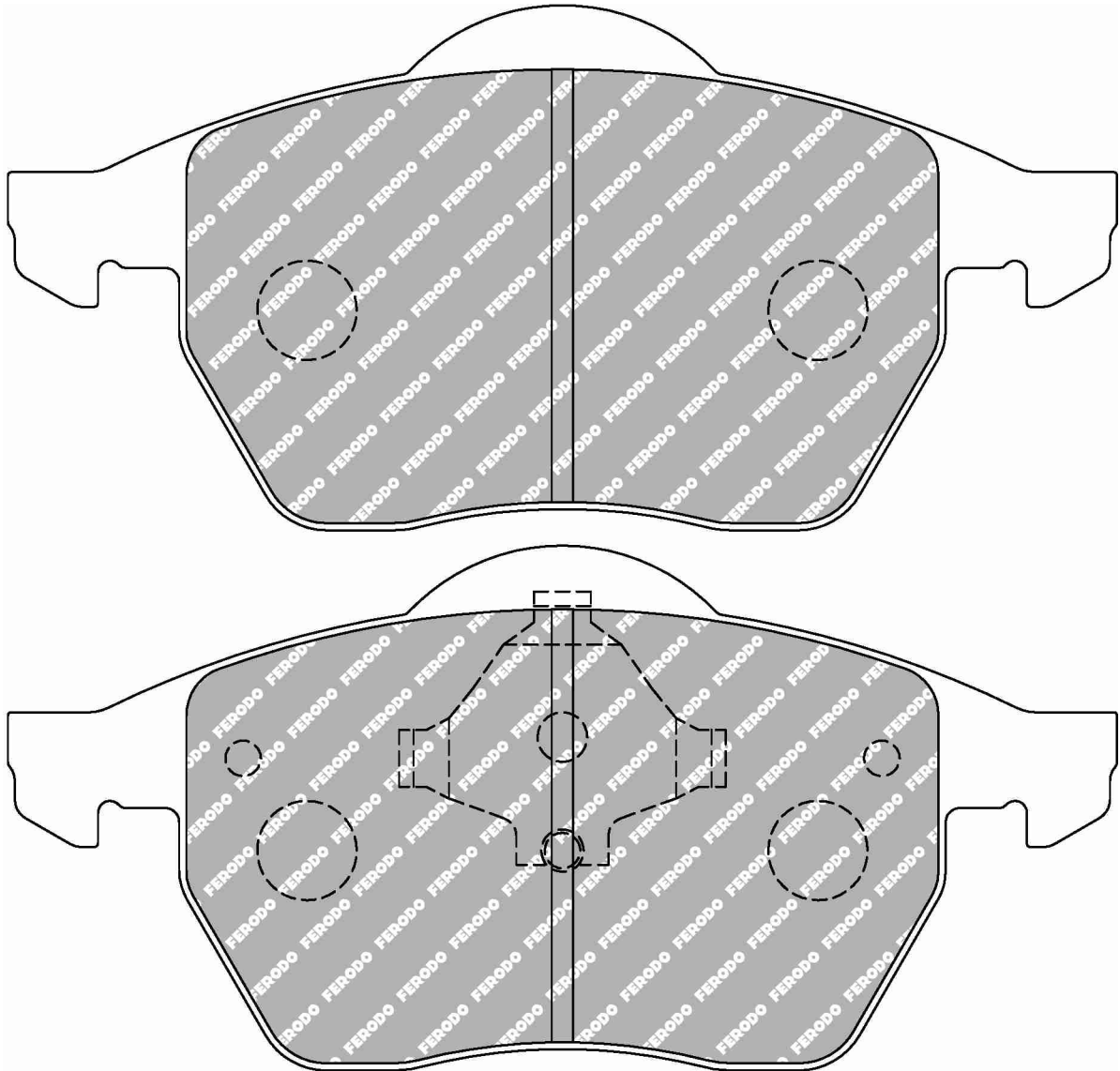

MATERIAL AVAILABILITY						
H	C	R	W	WB	Z	ZB
✓		✓	✉			

CROSS REFERENCE	
BREMBO	07.8300.14
BREMBO	07.8300.38
BREMBO	07.8300.40
BREMBO	07.8301.73
FMSI	D555
FMSI	D687
HAWK	HB269 .763A
MINTEX	MDB1531
PAGID	1678
WVA	20676 19,50 - 21624&21625 19,50

FCP596

WVA No: 21144 16,50

FMSI No: D228



88.0mm = 3.465"



68.0mm = 2.677"



16.6mm = 0.654"

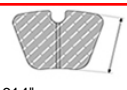

41.0mm = 1.614"

ALFA ROMEO Rear, AUDI Rear, FIAT Rear, LANCIA Rear, VOLKSWAGEN Rear

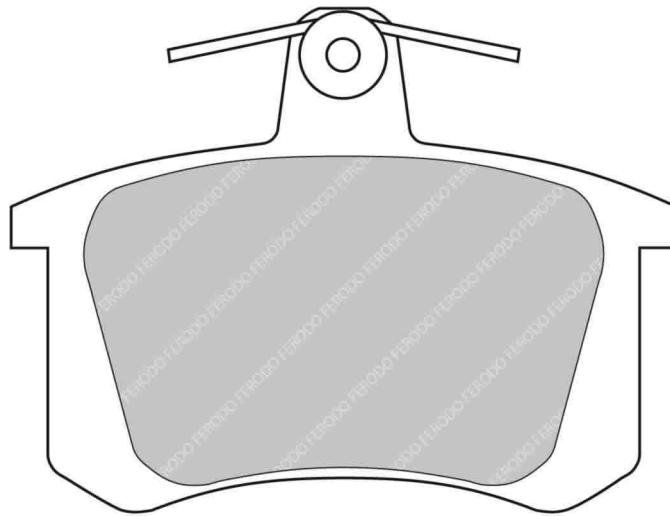

MATERIAL AVAILABILITY						
H	C	R	W	WB	Z	ZB
✓		✓				

CROSS REFERENCE	
BREMBO	07.8301.21
CL BRAKES	4010
FMSI	D228
HAWK	HB271 0,635
MINTEX	MDB1191
PAGID	3242
WVA	21144 16,50

✓ Available ⚠ Exhausting
 ✗ Out of Range 📦 Make to order
 📌 In Introduction

FCP598

WVA No: 21322 15,00

FMSI No: D373

HONDA Front



132.0mm = 5.197"

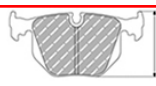

50.0mm = 1.969"



14.8mm = 0.583"

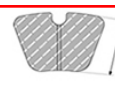

45.0mm = 1.772"

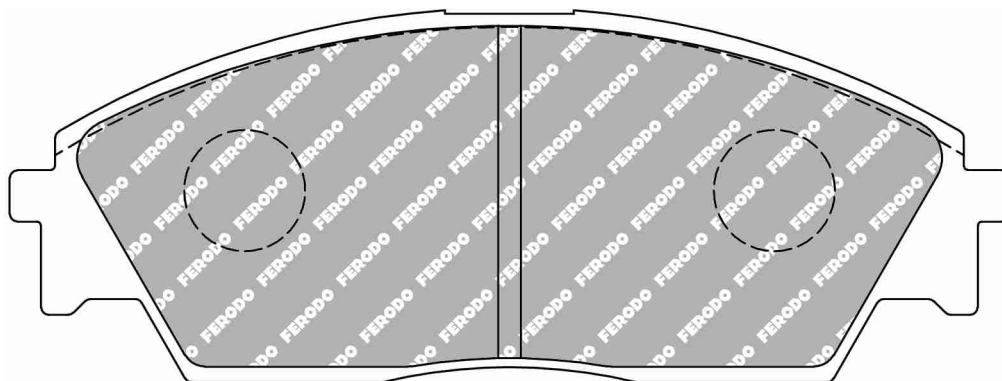

MATERIAL AVAILABILITY						
H	C	R	W	WB	Z	ZB
✓		✓				

CROSS REFERENCE	
BREMBO	07.8301.22
CL BRAKES	4083
FMSI	D373
HAWK	HB113 0,59
MINTEX	MDB1374
MINTEX	MDB1525
PAGID	8010
PFC	0373.XX
WVA	21322 15,00

FCP600

WVA No: 21526 17,00

FMSI No: D449



135.0mm = 5.315"



54.0mm = 2.126"



16.8mm = 0.661"



46.1mm = 1.815"

DAEWOO Front, HYUNDAI Front, INFINITI Front, NISSAN Front, SSANGYONG Front

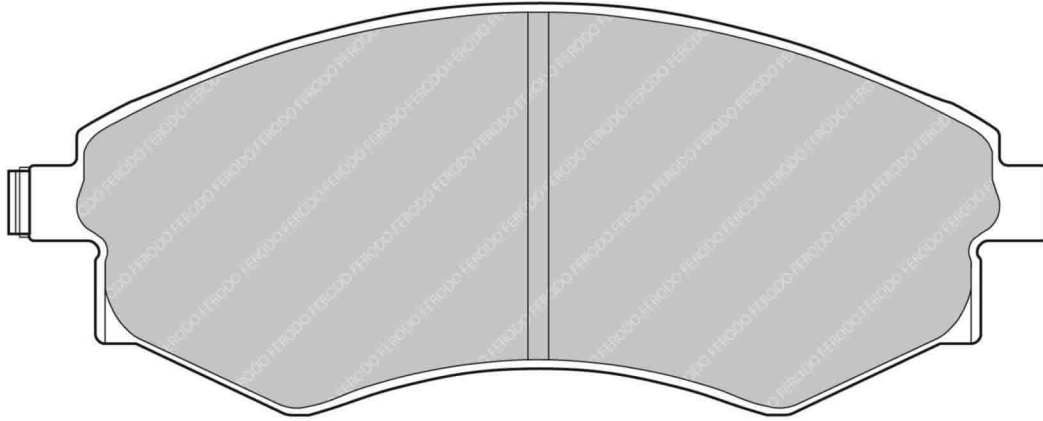

MATERIAL AVAILABILITY

H	C	R	W	WB	Z	ZB
✓		✗				

CROSS REFERENCE

BREMBO	07.8301.23
FMSI	D449
FMSI	D462
FMSI	D485
FMSI	D700
HAWK	HB235 0,665
HAWK	HB261 0,665
MINTEX	MDB1488
MINTEX	MDB2351
WVA	21526 17,00

FCP602

WVA No: 21294 15,00



120.2mm = 4.732"



54.0mm = 2.126"



15.1mm = 0.594"



49.3mm = 1.941"

TOYOTA Front

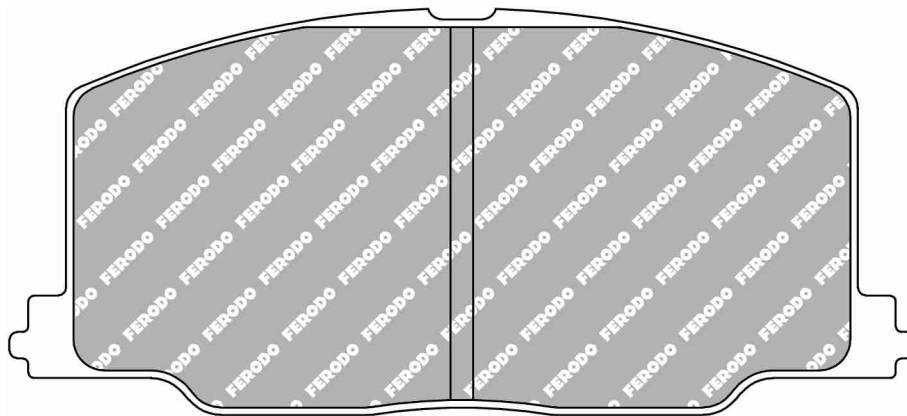

MATERIAL AVAILABILITY

H	C	R	W	WB	Z	ZB
✓		✗				

CROSS REFERENCE

BREMBO	07.8301.24
MINTEX	MDB1400
WVA	21294 15,00

✓ Available
 ✗ Out of Range
 ⓘ In Introduction
 ⚠ Exhausting
 📦 Make to order

FERODO
RACING
 Updated on 17th Aug 2018

3041

FCP613

WVA No: 21515 17,50



129.3mm = 5.091"



69.2mm = 2.724"



17.3mm = 0.681"



48.0mm = 1.890"

HONDA Front, LAND ROVER Front, MG Front, ROVER Front

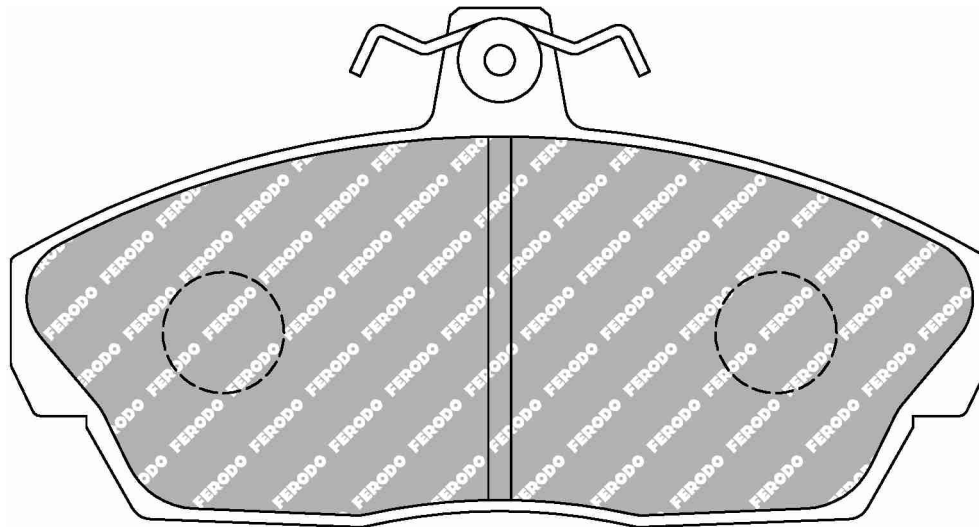

MATERIAL AVAILABILITY						
H	C	R	W	WB	Z	ZB
✓		✓				

CROSS REFERENCE	
BREMBO	07.8301.25
MINTEX	MDB1659
MINTEX	MDB1972
WVA	21515 17,50

FCP617

WVA No: 21171 19,00



131.0mm = 5.157"



58.0mm = 2.283"



18.0mm = 0.709"

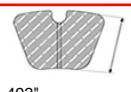

37.9mm = 1.492"

FORD Front

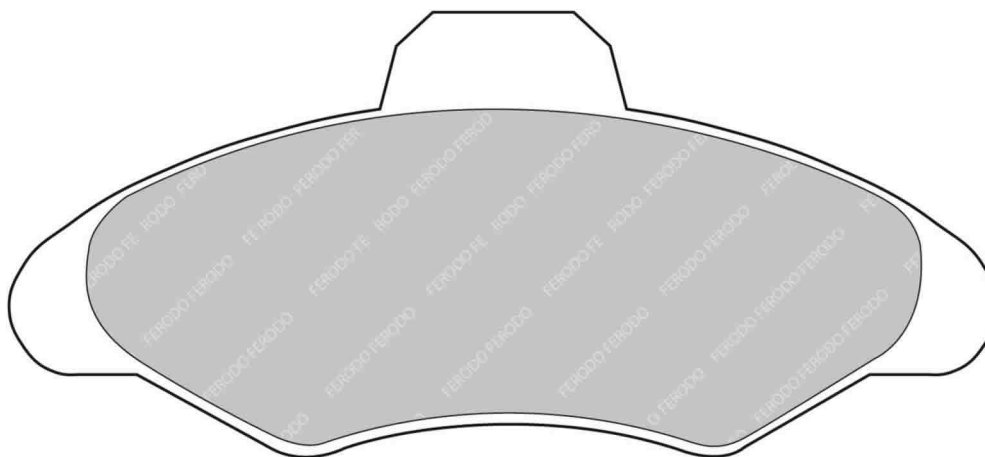

MATERIAL AVAILABILITY						
H	C	R	W	WB	Z	ZB
✓						

CROSS REFERENCE	
BREMBO	07.8301.26
MINTEX	MDB1493
WVA	21171 19,00

FCP638

WVA No: 21553 14,00

FMSI No: D272

HYUNDAI Rear



85.5mm = 3.366"



46.0mm = 1.811"



15.0mm = 0.591"



36.5mm = 1.437"

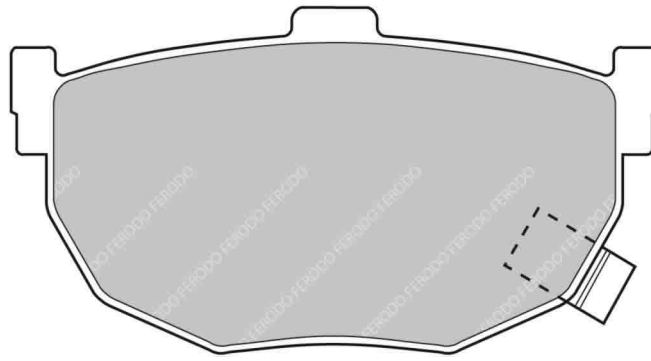

MATERIAL AVAILABILITY						
H	C	R	W	WB	Z	ZB
✓						

CROSS REFERENCE	
FMSI	D272
FMSI	D323
FMSI	D464
HAWK	HB262 0,54
MINTEX	MDB2352
WVA	21553 14,00

FCP646

WVA No: 21153 17,50

MERCEDES Front



99.9mm = 3.933"



74.0mm = 2.913"



18.2mm = 0.717"



56.0mm = 2.205"

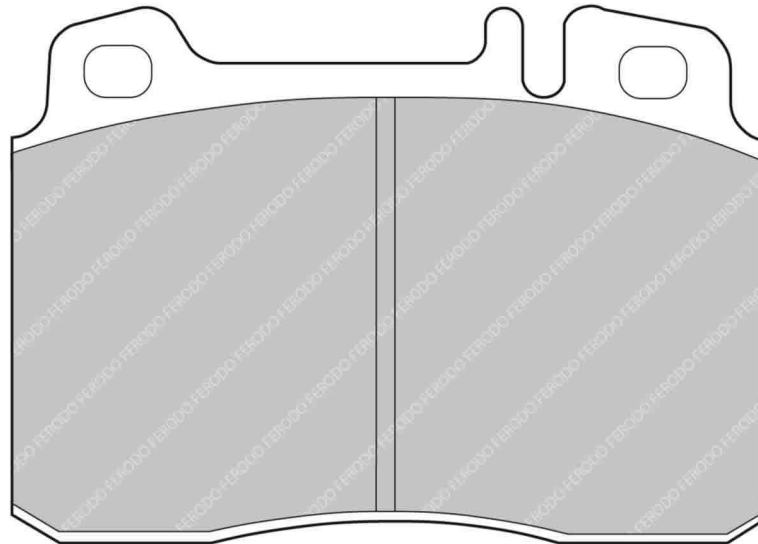

MATERIAL AVAILABILITY						
H	C	R	W	WB	Z	ZB
✓			✉			

CROSS REFERENCE	
MINTEX	MDB1503
WVA	21153 17,50

FCP647

WVA No: 21271 17,00



95.0mm = 3.740"



63.0mm = 2.480"



17.0mm = 0.669"

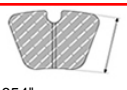

42.0mm = 1.654"

ALFA ROMEO Front

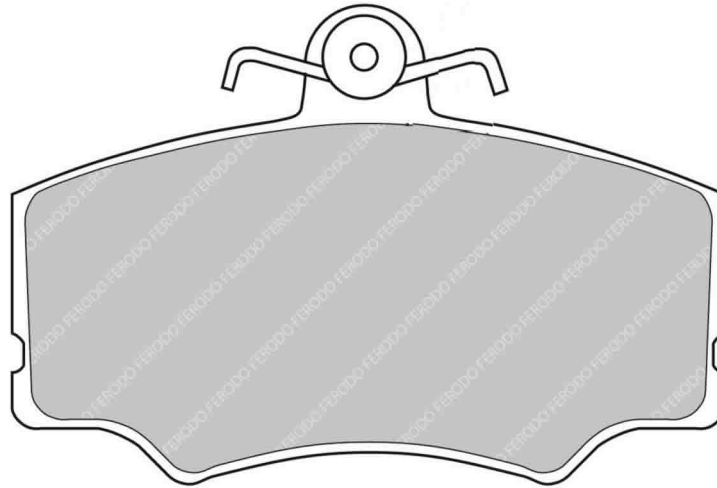

MATERIAL AVAILABILITY						
H	C	R	W	WB	Z	ZB

CROSS REFERENCE	
MINTEX	MDB1511
WVA	21271 17,00

FCP653

WVA No: 21552 14,00

FMSI No: D525



110.1mm = 4.335"



46.2mm = 1.819"



14.0mm = 0.551"

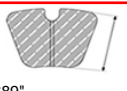

42.9mm = 1.689"

MAZDA Front

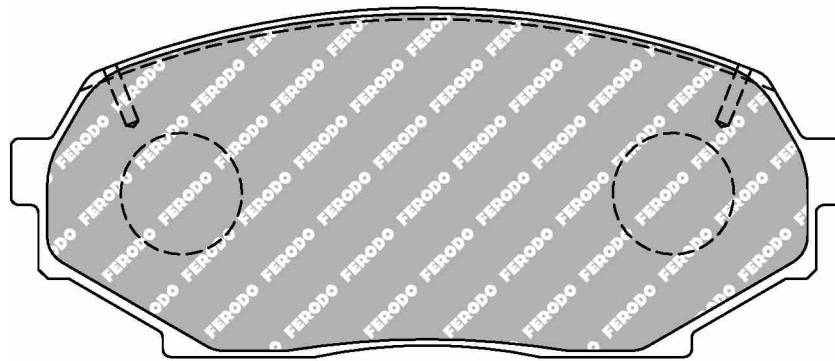

MATERIAL AVAILABILITY						
H	C	R	W	WB	Z	ZB

CROSS REFERENCE	
FMSI	D525
MINTEX	MDB1413
OE MAZDA	NAY03323ZA
WVA	21552 14,00

FCP660

WVA No: 21173 17,00



94.8mm = 3.732"



55.0mm = 2.165"



17.0mm = 0.669"



46.5mm = 1.831"

BMW Front, MERCEDES Front, SAAB Front

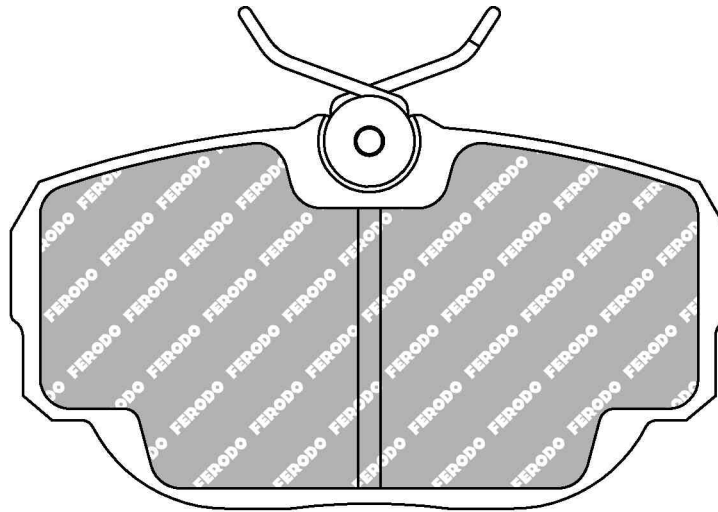

Replacing FCP303

MATERIAL AVAILABILITY

H	C	R	W	WB	Z	ZB
✓		✓	✉			

CROSS REFERENCE

MINTEX	MDB1401
MINTEX	MDB1473
MINTEX	MDB1583
PAGID	1544
WVA	21173 17,00

✓ Available ⚠ Exhausting
 ✗ Out of Range ✉ Make to order
 📧 In Introduction

FCP685

WVA No: 21560 18,00

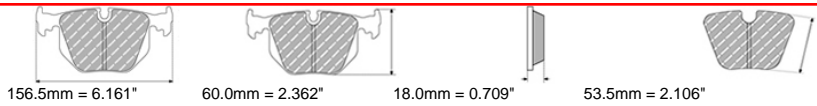

FORD Front, JAGUAR Front, OPEL Front, SAAB Front, VAUXHALL Front

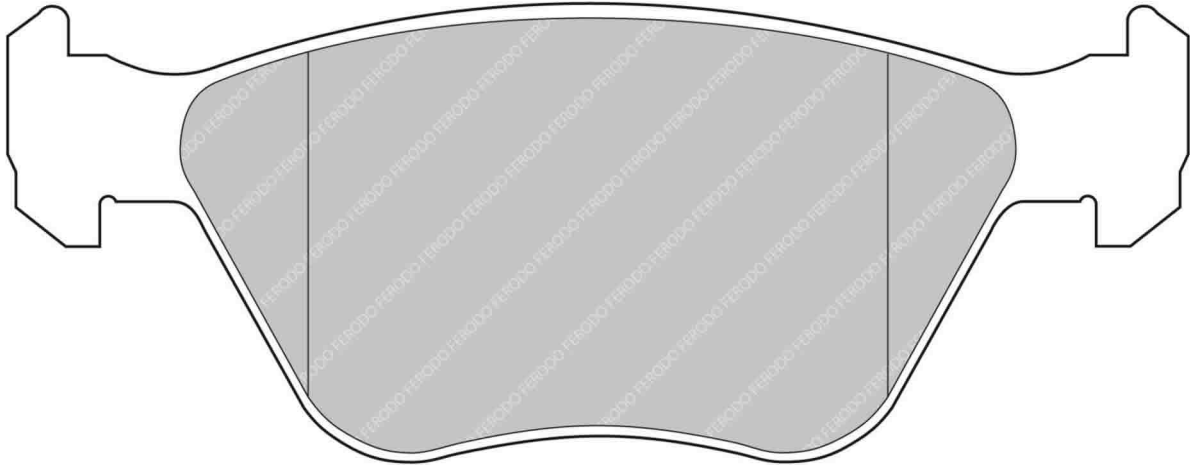

MATERIAL AVAILABILITY						
H	C	R	W	WB	Z	ZB
✓		✓				

CROSS REFERENCE	
ALCON	PNF0084X235
ALCON	PNF0084X235.4
BREMBO	07.8301.28
MINTEX	MDB1637
PAGID	1675
PFC	0394
PFC	7760
WVA	21560 18,00

FCP691

WVA No: 21561 17,00

FMSI No: D430



INFINITI Front, NISSAN Front

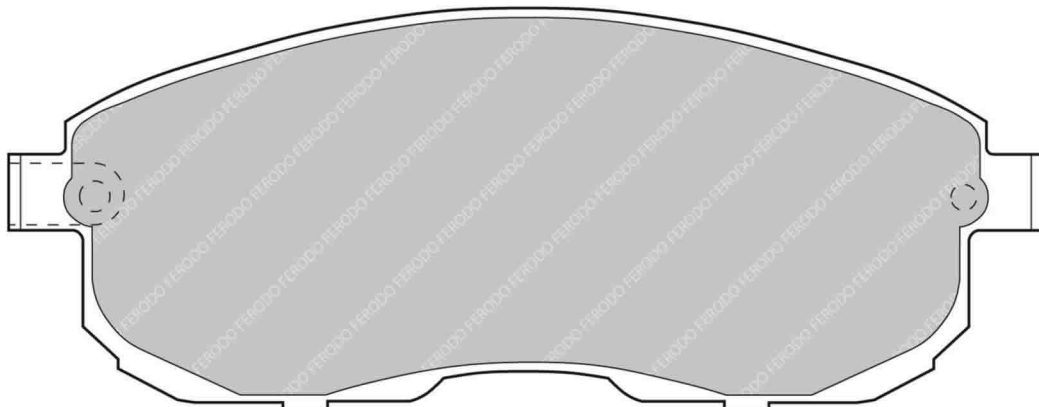

MATERIAL AVAILABILITY						
H	C	R	W	WB	Z	ZB
✓						

CROSS REFERENCE	
BREMBO	07.8300.07
FMSI	D430
HAWK	HB268 0,665
MINTEX	MDB1451
WVA	21561 17,00

FCP721

WVA No: 21381 16,80

FMSI No: D1053

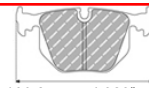

109.8mm = 4.323"



69.0mm = 2.717"



17.3mm = 0.681"

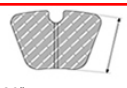

51.3mm = 2.020"

ALFA ROMEO Front, CHEVROLET Rear, DODGE Front, FIAT Front, LANCIA Front

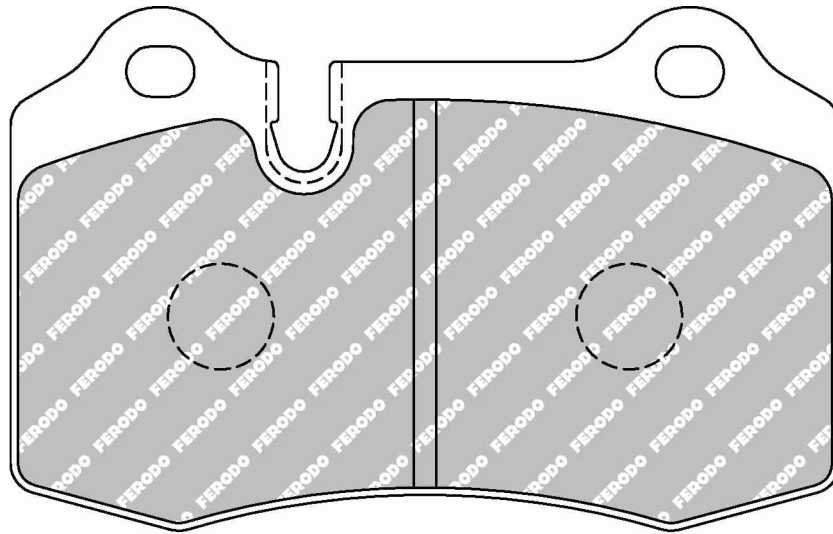

ALSO AVAILABLE

SHAPE	TH. MM	NOTES
FCP1348	15	
FRP3109	12.5	

MATERIAL AVAILABILITY

H	C	R	W	WB	Z	ZB
✓		✓	✉			

CROSS REFERENCE

BREMBO	07.7235.60
CL BRAKES	4022
FMSI	D1053
FMSI	D592
HAWK	HB194 0,57
HAWK	HB194 0,575
HAWK	HB194 0,665
MINTEX	MDB1633
MINTEX	MDB1877
PFC	0592.XX.17
WVA	21381 16,80

✓ Available ⚠ Exhausting
 ✗ Out of Range ✉ Make to order
 ⓘ In Introduction

FERODO
RACING
 Updated on 17th Aug 2018

3047

FCP725

WVA No: 21292 17,30

FMSI No: D558

BMW Front



151.5mm = 5.965"



57.0mm = 2.244"



16.4mm = 0.646"

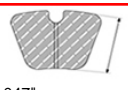

52.0mm = 2.047"

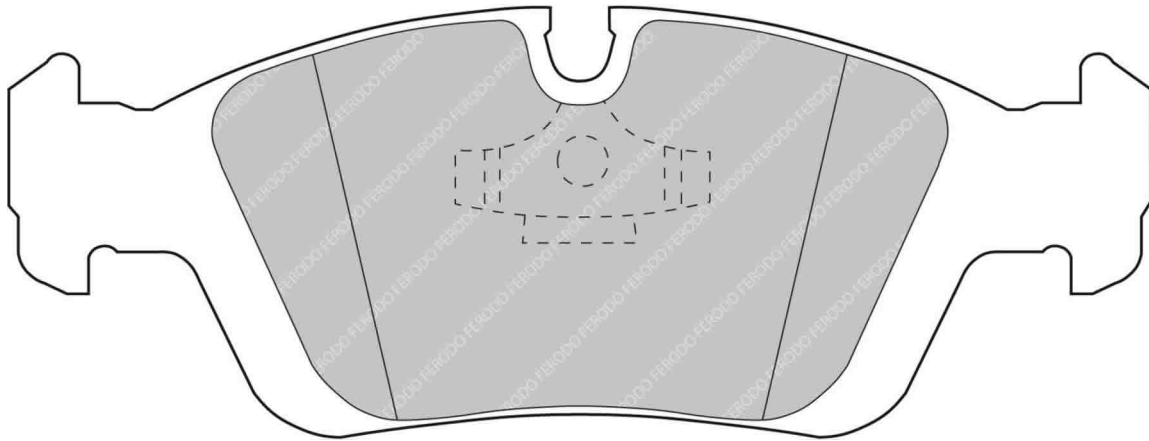

MATERIAL AVAILABILITY						
H	C	R	W	WB	Z	ZB
✓		✓	✓			

CROSS REFERENCE	
BREMBO	07.8300.09
BREMBO	07.8301.68
FMSI	D558
HAWK	HB136 0,69
MINTEX	MDB1065
MINTEX	MDB1538
PAGID	2180
PFC	0558
PFC	0558.XX
WVA	21292 17,30

FCP726

WVA No: 21589 15,00

FMSI No: D340

LANCIA Rear



88.0mm = 3.465"



53.0mm = 2.087"



14.4mm = 0.567"



41.0mm = 1.614"

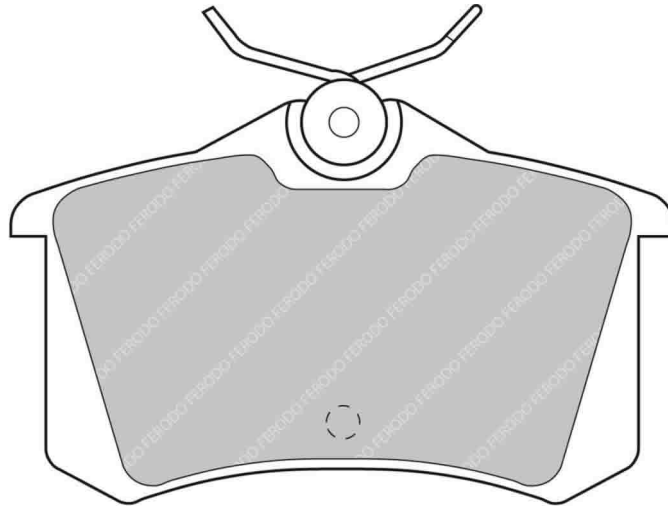

MATERIAL AVAILABILITY

H	C	R	W	WB	Z	ZB
✓		✓				

CROSS REFERENCE

CL BRAKES	4038
FMSI	D340
WVA	21589 15,00

✓ Available ⚠ Exhausting
 ✗ Out of Range 📦 Make to order
 📅 In Introduction

FCP732

WVA No: 20547 16,80



141.4mm = 5.567"
141.4mm = 5.567"



49.0mm = 1.929"
59.0mm = 2.323"



16.0mm = 0.630"
16.0mm = 0.630"

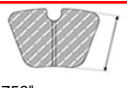

44.6mm = 1.756"
44.6mm = 1.756"

ASTON MARTIN Rear, DAEWOO Front, OPEL Front, VAUXHALL Front

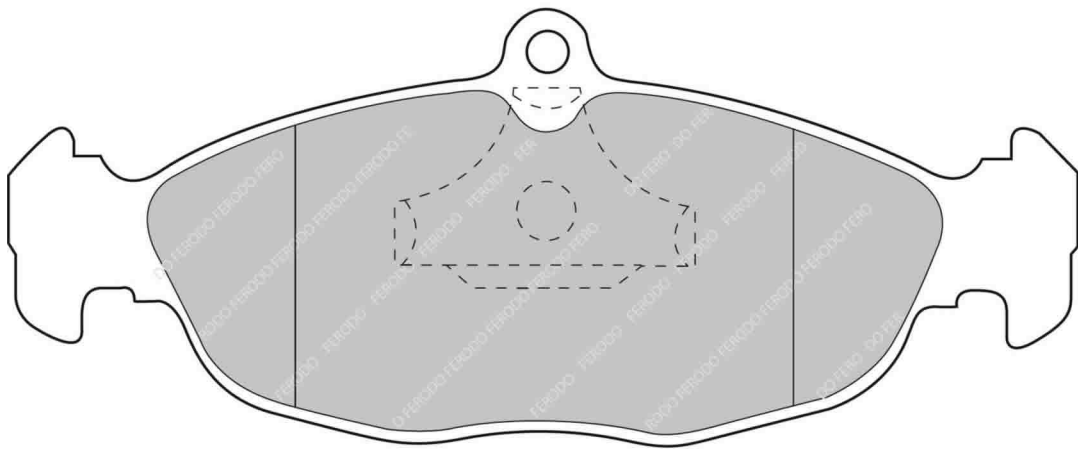

MATERIAL AVAILABILITY

H	C	R	W	WB	Z	ZB
✓		✓				

CROSS REFERENCE

BREMBO	07.8301.29
MINTEX	MDB1556
WVA	20547 16,80

3050

FERODO

RACING
Updated on 17th Aug 2018

✓ Available ⚠ Exhausting
 ✗ Out of Range 📦 Make to order
 🔄 In Introduction

FCP748

WVA No: 21446 17,80

FMSI No: D341

ACURA Front, HONDA Front



129.0mm = 5.079"



52.0mm = 2.047"



17.9mm = 0.705"

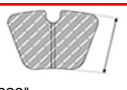

49.0mm = 1.929"

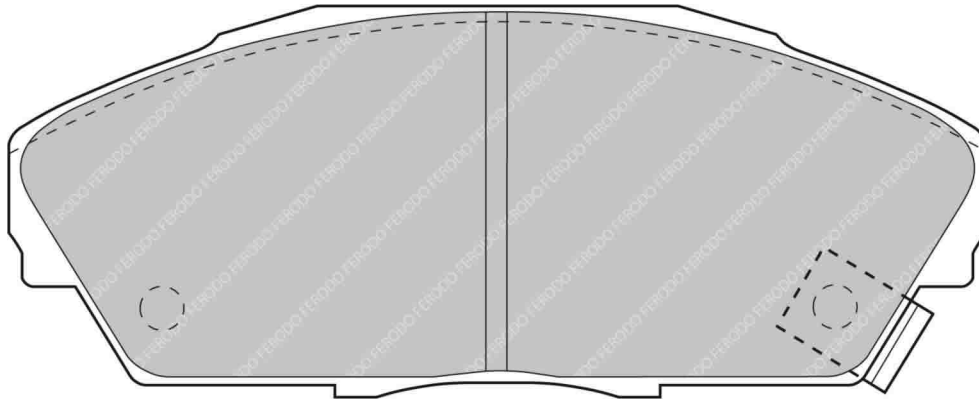

MATERIAL AVAILABILITY						
H	C	R	W	WB	Z	ZB
✓						

CROSS REFERENCE	
BREMBO	07.8300.17
BREMBO	07.8300.23
FMSI	D341
FMSI	D409
HAWK	HB242 0,661
MINTEX	MDB1589
PAGID	1596
PFC	0409.XX
WVA	21446 17,80

FCP761

FMSI No: D465

ACURA Front, HONDA Front



137.9mm = 5.429"



52.0mm = 2.047"



18.5mm = 0.728"

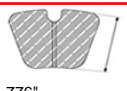

45.1mm = 1.776"

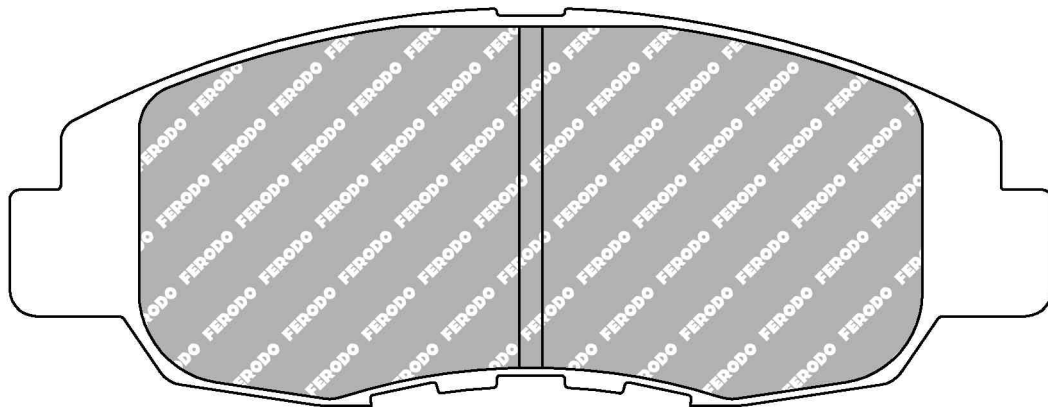

MATERIAL AVAILABILITY						
H	C	R	W	WB	Z	ZB
✗						

CROSS REFERENCE	
BREMBO	07.8300.18
CL BRAKES	4102
FMSI	D465
FMSI	D764
HAWK	HB275 0,62
MINTEX	MDB1533
PFC	0465.XX

- ✓ Available
- ✗ Out of Range
- 📧 In Introduction
- ⚠ Exhausting
- 📄 Make to order

FCP765

WVA No: 21363 15,70

FMSI No: D530

DODGE Front, MITSUBISHI Front



149.8mm = 5.898"



58.6mm = 2.307"



15.7mm = 0.618"

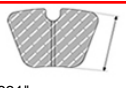

46.5mm = 1.831"

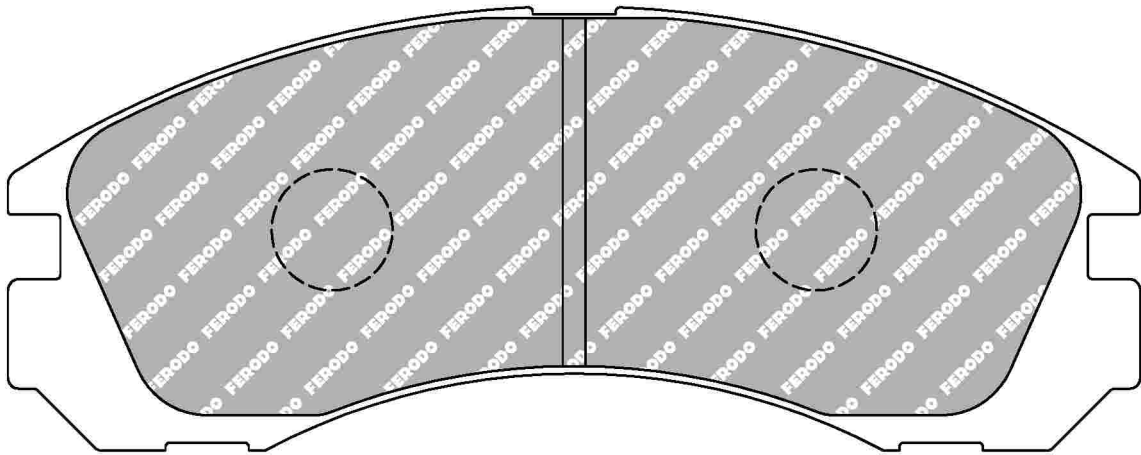

MATERIAL AVAILABILITY						
H	C	R	W	WB	Z	ZB
✓		✓	✓		✓	

CROSS REFERENCE	
FMSI	D530
FMSI	D723
HAWK	HB214 0,618
MINTEX	MDB1539
OE Mitsubishi	4605A492
PAGID	1591
PFC	0530.XX
WVA	21363 15,70

FCP766

WVA No: 21395 18,00

FMSI No: D648

FORD Front



156.5mm = 6.161"
155.3mm = 6.114"



58.6mm = 2.307"
58.6mm = 2.307"



18.0mm = 0.709"
18.0mm = 0.709"

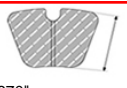

47.5mm = 1.870"
47.5mm = 1.870"

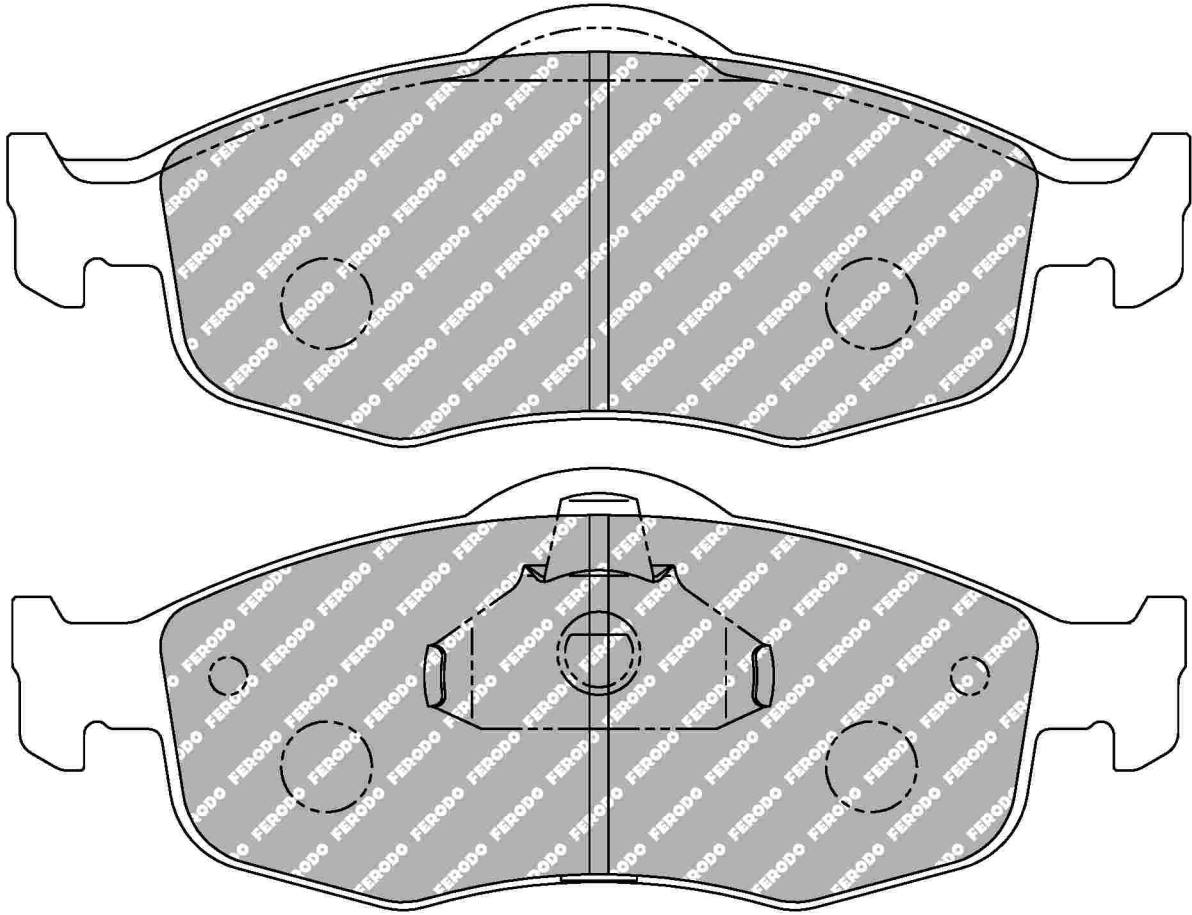

MATERIAL AVAILABILITY

H	C	R	W	WB	Z	ZB
✘		✉				

CROSS REFERENCE

BREMBO	07.8301.30
FMSI	D648
HAWK	HB420 0,748
MINTEX	MDB1622
PFC	0648.XX
WVA	21395 18,00

✓ Available ⚠ Exhausting
 ✘ Out of Range ✉ Make to order
 ⓘ In Introduction

FERODO
RACING
 Updated on 17th Aug 2018

3053

FCP767

WVA No: 21583 18,80



156.5mm = 6.161"



60.0mm = 2.362"



19.0mm = 0.748"

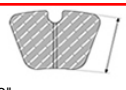

55.2mm = 2.173"

FORD Front

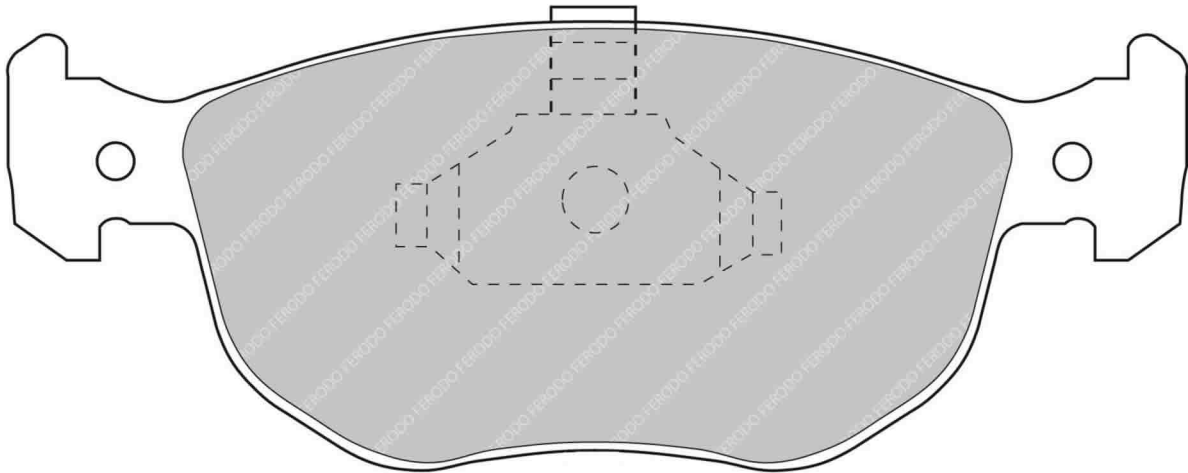

MATERIAL AVAILABILITY

H	C	R	W	WB	Z	ZB
✓		✗				

CROSS REFERENCE

ALCON	PNF0084X238.4
BREMBO	07.8301.31
MINTEX	MDB1810
MINTEX	MDB1895
MINTEX	MDB2193
WVA	21583 18,80

FCP774

WVA No: 20168 16,20

FMSI No: D227



119.0mm = 4.685"



70.0mm = 2.756"



16.2mm = 0.638"

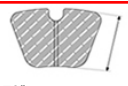

47.5mm = 1.870"

AUDI Front, SEAT Front, VOLKSWAGEN Front

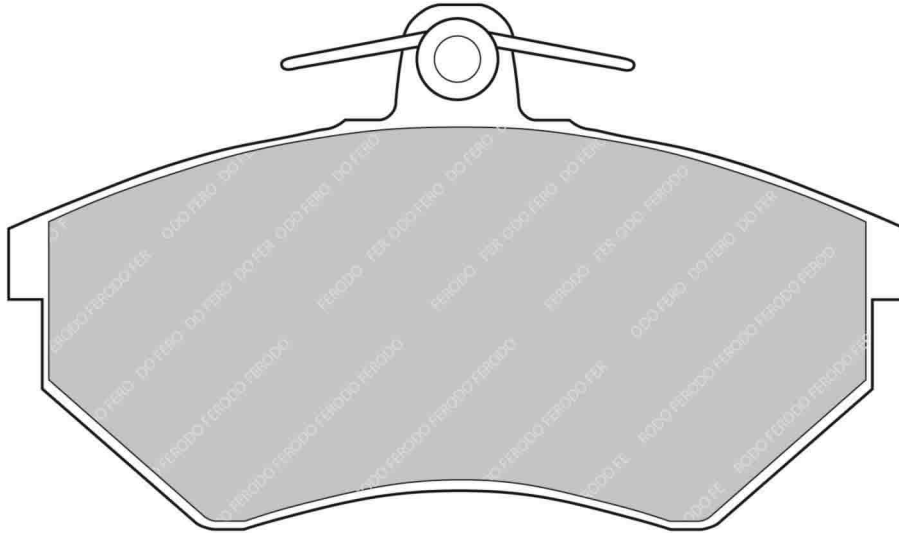

ALSO AVAILABLE

SHAPE	TH. MM	NOTES
FCP775	19.6	

MATERIAL AVAILABILITY

H	C	R	W	WB	Z	ZB
✓	✗	✓				

CROSS REFERENCE

BREMBO	07.8301.32
BREMBO	07.8301.71
CL BRAKES	4011
FMSI	D227
FMSI	D696
HAWK	HB190 .600A
MINTEX	MDB1253
MINTEX	MDB1371
MINTEX	MDB1570
PAGID	1743
WVA	20168 16,20

FCP775

WVA No: 20168 19,60

FMSI No: D227

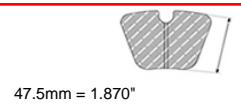
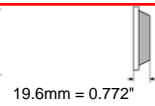
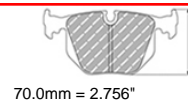
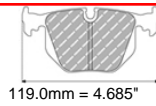

AUDI Front, SEAT Front, VOLKSWAGEN Front

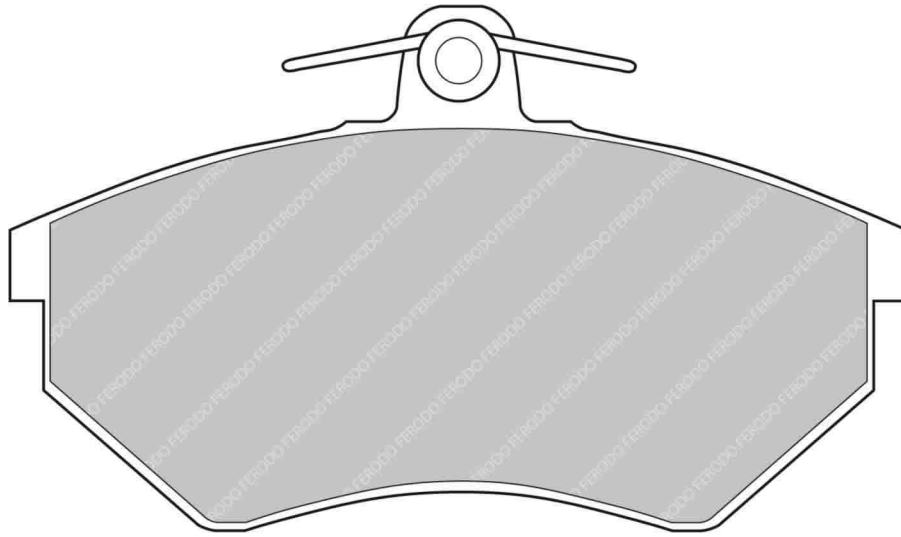

ALSO AVAILABLE		
SHAPE	TH. MM	NOTES
FCP774	16.2	

MATERIAL AVAILABILITY						
H	C	R	W	WB	Z	ZB
✓		✓				

CROSS REFERENCE	
BREMBO	07.8300.02
BREMBO	07.8301.63
CL BRAKES	4011
FMSI	D227
FMSI	D290
FMSI	D684
HAWK	HB190 .730A
MINTEX	MDB1190
MINTEX	MDB1571
PAGID	1744
WVA	20168 19,60

FCP776

WVA No: 21694 16,50

FMSI No: D621

AUDI Front, HONDA Front



136.5mm = 5.374"



58.0mm = 2.283"



16.5mm = 0.650"

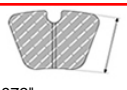

50.1mm = 1.972"

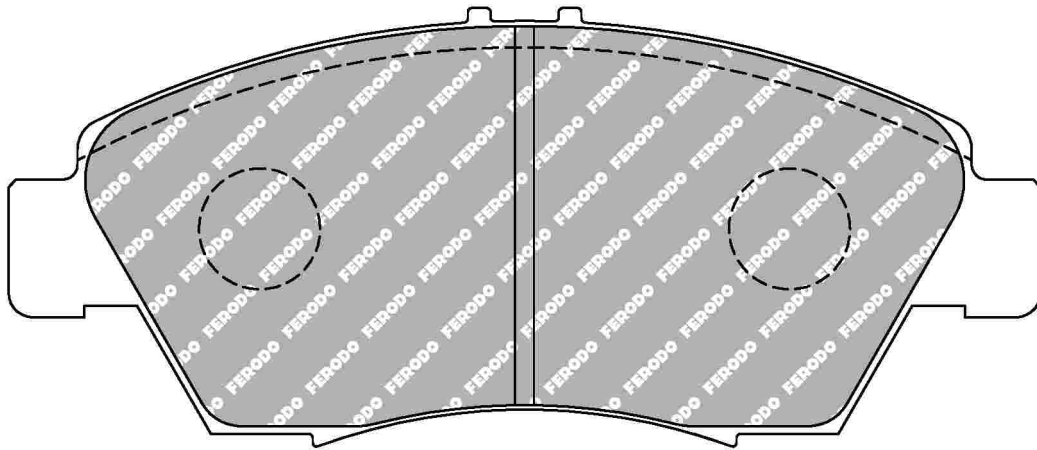

MATERIAL AVAILABILITY						
H	C	R	W	WB	Z	ZB
✓		✓			✉	

CROSS REFERENCE	
BREMBO	07.8300.01
FMSI	D621
MINTEX	MDB1610
PFC	0621
WVA	21694 16,50

FCP777

WVA No: 21697 15,80

FMSI No: D568

HONDA Front



131.4mm = 5.173"



53.0mm = 2.087"



15.0mm = 0.591"

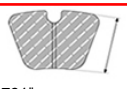

45.5mm = 1.791"

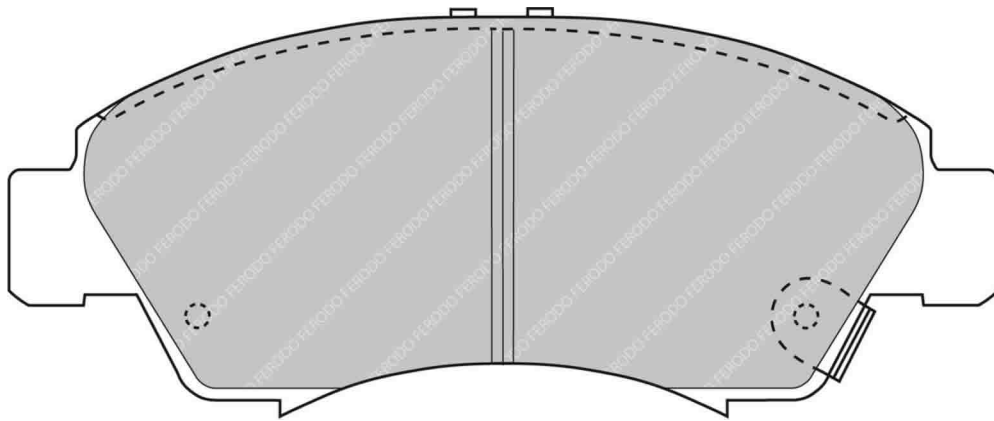

MATERIAL AVAILABILITY						
H	C	R	W	WB	Z	ZB
✓						

CROSS REFERENCE	
BREMBO	07.8301.33
CL BRAKES	4077
FMSI	D568
MINTEX	MDB1615
WVA	21697 15,80

- ✓ Available
- ✗ Out of Range
- ✉ In Introduction
- ⚠ Exhausting
- ✉ Make to order

FCP779

WVA No: 20968 20,30

FMSI No: D394



156.5mm = 6.161"
156.5mm = 6.161"



64.4mm = 2.535"
64.4mm = 2.535"



20.5mm = 0.807"
20.5mm = 0.807"

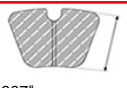

58.6mm = 2.307"
58.6mm = 2.307"

BMW Front

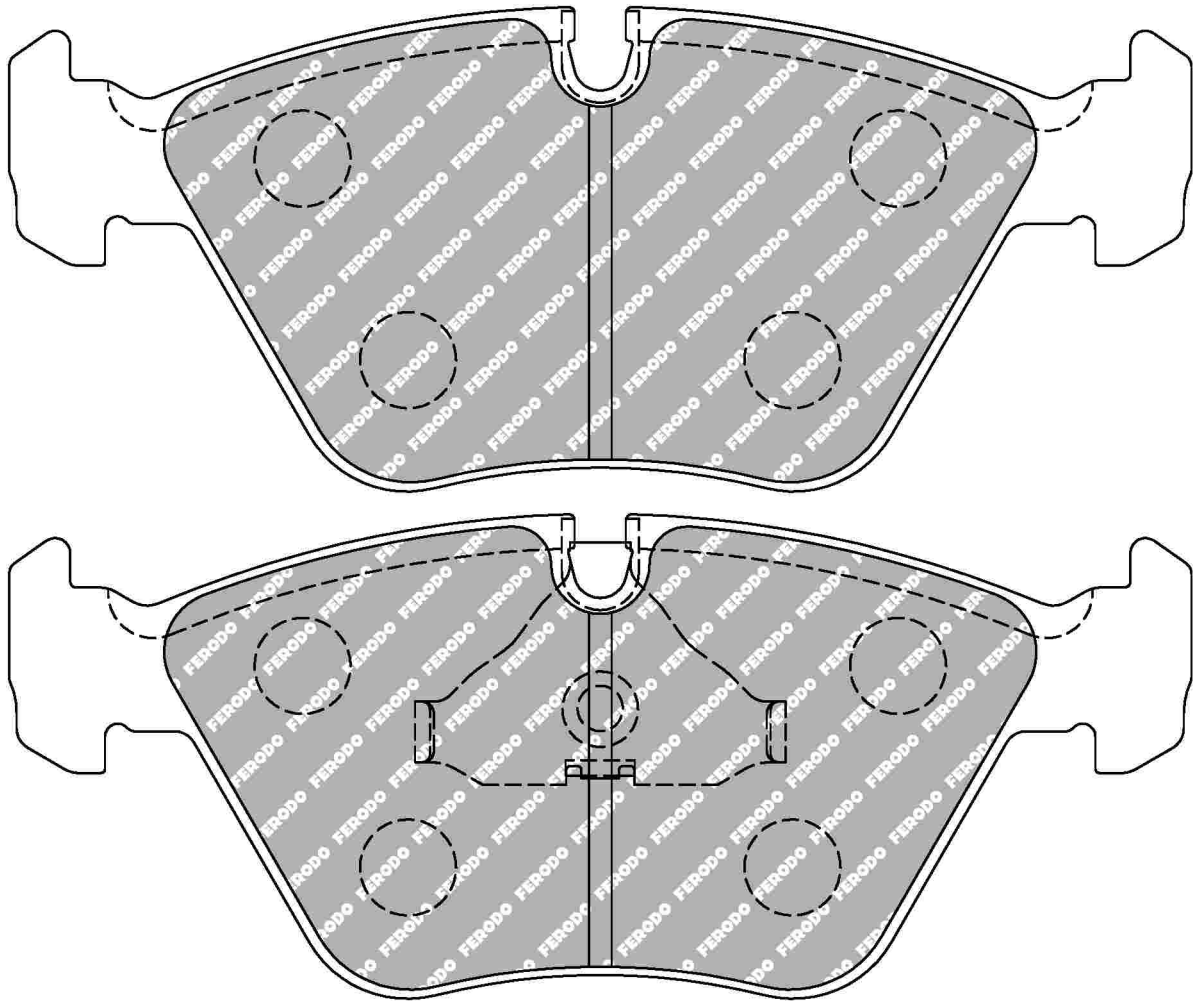

MATERIAL AVAILABILITY

H	C	R	W	WB	Z	ZB
✓		✓	✉			

CROSS REFERENCE

BREMBO	07.8300.10
BREMBO	07.8301.50
CL BRAKES	4033
FMSI	D394
FMSI	D725
HAWK	HB135 0,77
MINTEX	MDB1393
PAGID	1295
PFC	0394.XX
WVA	20968 20,30

3058

FERODO

RACING
Updated on 17th Aug 2018

✓ Available ⚠ Exhausting
 ✗ Out of Range ✉ Make to order
 🔄 In Introduction

FCP789

WVA No: 21495 17,00

FMSI No: D470

SUBARU Front



128.1mm = 5.043"



53.0mm = 2.087"



16.1mm = 0.634"



43.7mm = 1.720"

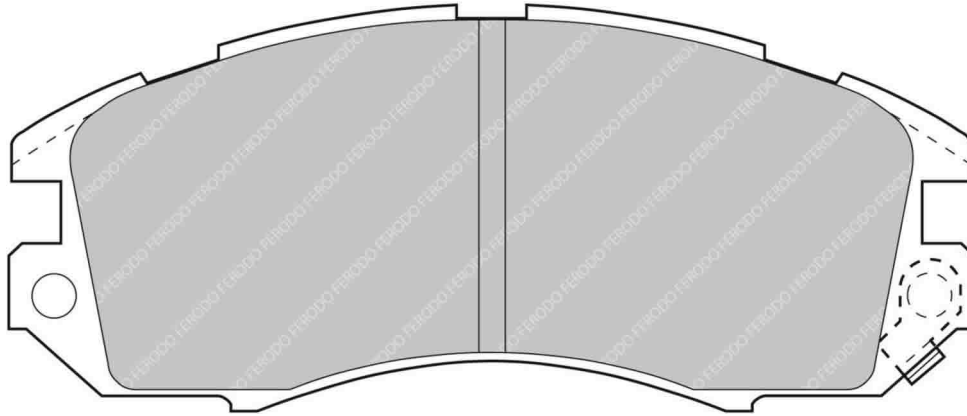

MATERIAL AVAILABILITY

H	C	R	W	WB	Z	ZB
✓		✓				

CROSS REFERENCE

BREMBO	07.8301.34
CL BRAKES	4018
FMSI	D470
HAWK	HB408 0,665
MINTEX	MDB1496
PAGID	1349
WVA	21495 17,00

FCP790

WVA No: 21703 14,80

FMSI No: D471

SUBARU Rear



108.1mm = 4.256"



38.0mm = 1.496"



14.6mm = 0.575"



33.1mm = 1.303"

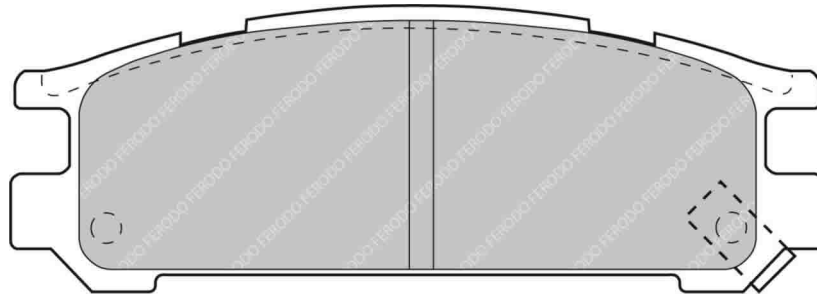

MATERIAL AVAILABILITY

H	C	R	W	WB	Z	ZB
✓		✓				

CROSS REFERENCE

CL BRAKES	4019
FMSI	D471
HAWK	HB367 0,585
MINTEX	MDB1497
WVA	21703 14,80

FCP809

WVA No: 20088 14,40

FMSI No: D044

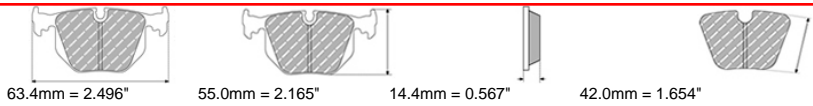

CATERHAM Front, CITROEN Rear, FORD Front, GINETTA Front, INNOCENTI Front, LAMBORGHINI Rear, LANCIA Rear, LOTUS Front, MORGAN Front, PEUGEOT Rear, PIPER Front / Rear, ROVER Front, TALBOT Front, VOLVO Rear

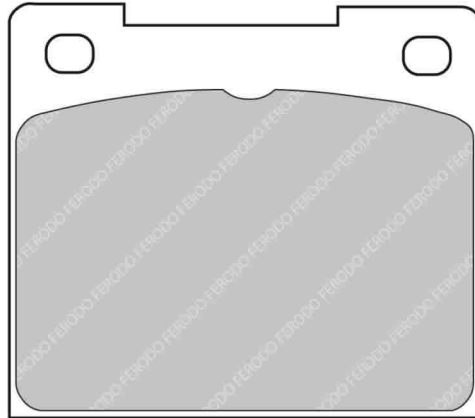

MATERIAL AVAILABILITY						
H	C	R	W	WB	Z	ZB
✓	✓	✓	✉		✓	

CROSS REFERENCE	
ALCON	PNF3451X521.4
ALCON	PNF3451X555.4
CL BRAKES	5002W43T14
EBC	DP114
FMSI	D044
HAWK	HB118 0,56
MINTEX	MDB1723
MINTEX	MGB533
PAGID	3102
PFC	0044
WVA	20088 14,40

FCP810

WVA No: 20089 14,40

FMSI No: D51

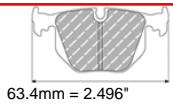

63.4mm = 2.496"

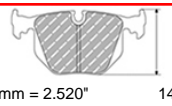

64.0mm = 2.520"



14.4mm = 0.567"

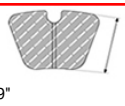

48.5mm = 1.909"

CITROEN Rear, FORD Front, HYUNDAI Front, JENSEN Front, ROVER Front, TALBOT Front, VAUXHALL Front, VOLVO Front

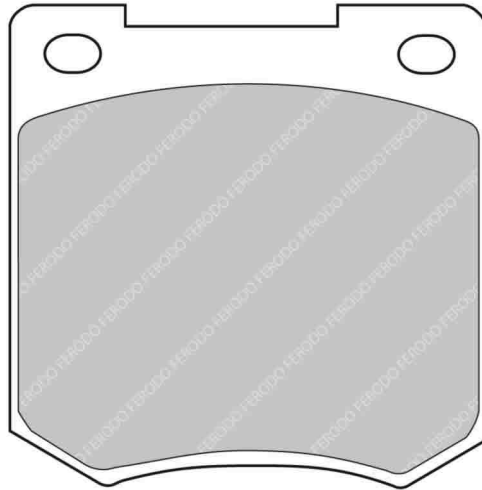

MATERIAL AVAILABILITY						
H	C	R	W	WB	Z	ZB
✓	✉	✓	✉		✉	

CROSS REFERENCE	
ALCON	PNF3451X522
ALCON	PNF3451X522.4
ALCON	PNF3451X554.4
ALCON	PNF3451X566.4
CL BRAKES	5002W48T14
FMSI	D51
MINTEX	MGB535
PAGID	3190
PFC	0051
WVA	20089 14,40

✓ Available ⚠ Exhausting
 ✗ Out of Range ✉ Make to order
 📅 In Introduction

FCP815

WVA No: 20007 15,30

FMSI No: D009

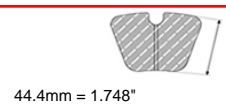
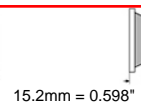
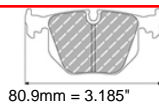

AC Rear, ASTON MARTIN Rear, BRISTOL Rear, FERRARI Rear, JAGUAR Rear, JENSEN Rear, MORGAN Rear, ROVER Rear, TRIUMPH Rear

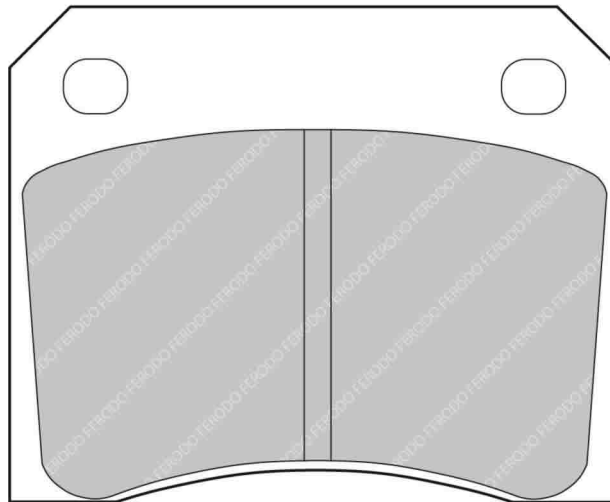

MATERIAL AVAILABILITY						
H	C	R	W	WB	Z	ZB
✓	✗	✓	✗			

CROSS REFERENCE	
FMSI	D009
MINTEX	MGB521
PAGID	8041
WVA	20007 15,30

FCP817

WVA No: 20380 15,50

FMSI No: D135

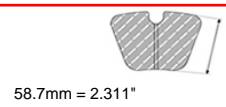
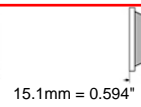
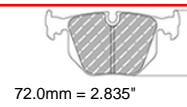
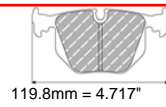

ASTON MARTIN Front, JAGUAR Front, RENAULT Front

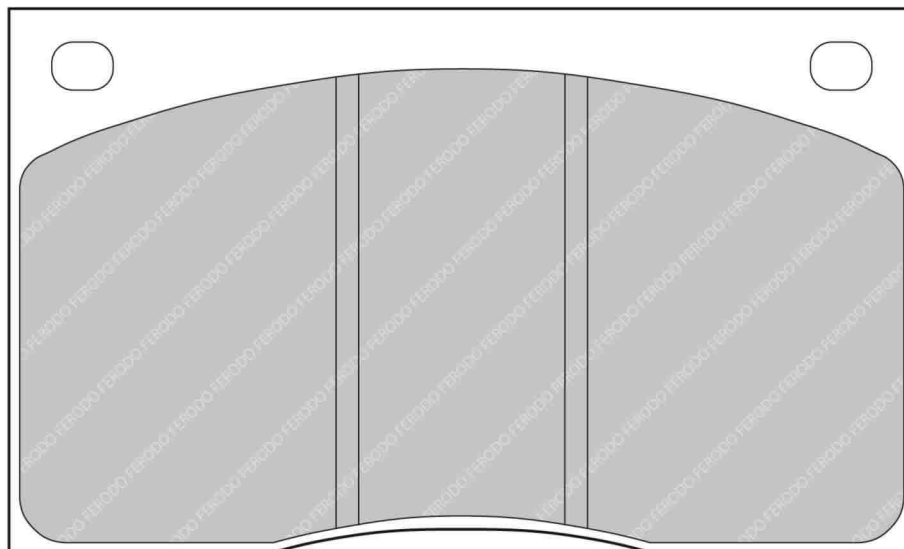

MATERIAL AVAILABILITY						
H	C	R	W	WB	Z	ZB
✓		✓				

CROSS REFERENCE	
FMSI	D135
MINTEX	CVP043
MINTEX	MGB585
WVA	20380 15,50

3062

FERODO
RACING
Updated on 17th Aug 2018

✓ Available ⚠ Exhausting
 ✗ Out of Range 📦 Make to order
 🔄 In Introduction

FCP823

WVA No: 20037 15,00

FMSI No: D027

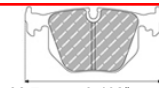

88.7mm = 3.492"



64.0mm = 2.520"



14.7mm = 0.579"



47.4mm = 1.866"

HUMBER Front, MG Front, SINGER Front, SUNBEAM Front

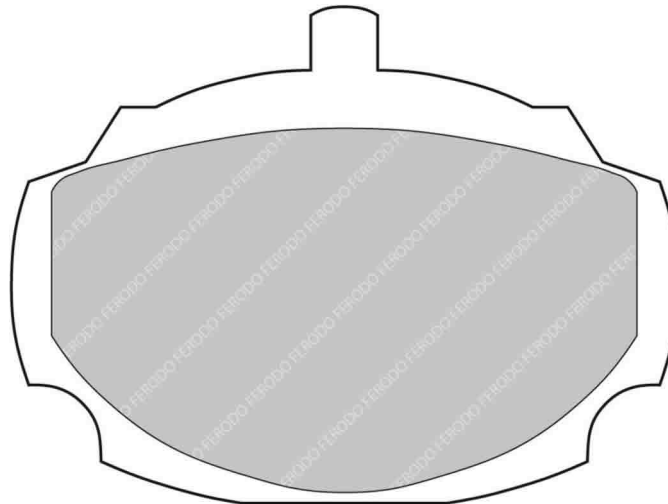

MATERIAL AVAILABILITY

H	C	R	W	WB	Z	ZB

CROSS REFERENCE

FMSI	D027
MINTEX	MLB10
WVA	20037 15,00

FCP825

WVA No: 20054 14,50

FMSI No: D005



70.0mm = 2.756"



57.9mm = 2.280"



14.5mm = 0.571"

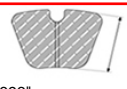

43.0mm = 1.693"

CATERHAM Rear, ROVER Front, VAUXHALL Rear

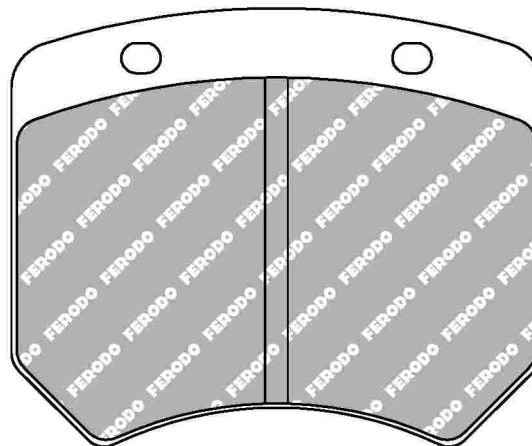

MATERIAL AVAILABILITY

H	C	R	W	WB	Z	ZB

CROSS REFERENCE

AP RACING	CP2399D43
CL BRAKES	5001W43T14
FMSI	D005
HAWK	HB108
MINTEX	MLB20
PAGID	1363
PFC	7720
WVA	20054 14,50

Available
 Out of Range
 In Introduction
 Exhausting
 Make to order

FERODO
RACING
Updated on 17th Aug 2018

3063

FCP832

WVA No: 20577 15,00

FMSI No: D081

MG Front, ROVER Front



99.0mm = 3.898"



72.0mm = 2.835"



14.7mm = 0.579"

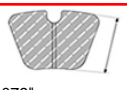

52.8mm = 2.079"

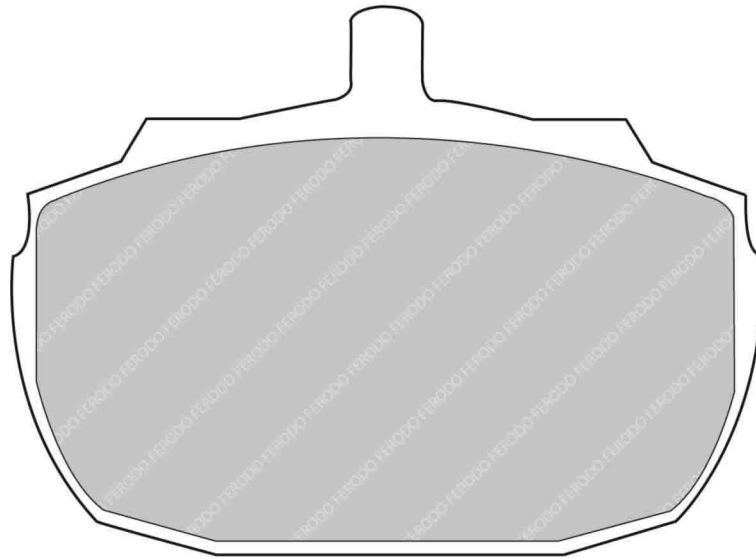

MATERIAL AVAILABILITY

H	C	R	W	WB	Z	ZB
✓		✓				

CROSS REFERENCE

FMSI	D081
MINTEX	MLB52
WVA	20577 15,00

FCP840

WVA No: 20754 15,00

RELIANT Front, ROVER Front



83.7mm = 3.295"



55.0mm = 2.165"



14.9mm = 0.587"

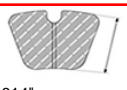

41.0mm = 1.614"

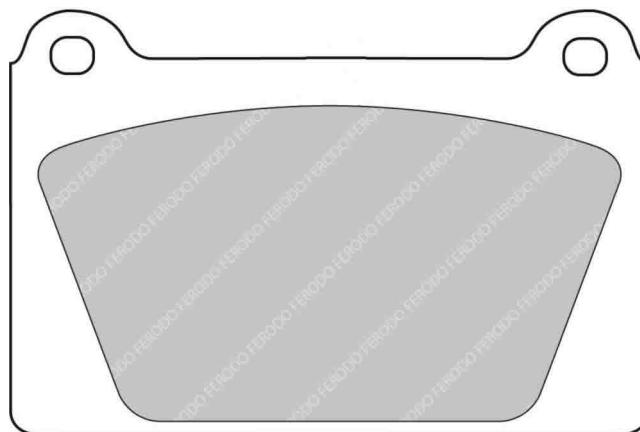

MATERIAL AVAILABILITY

H	C	R	W	WB	Z	ZB
	✉	✓				

CROSS REFERENCE

AP RACING	CP2712D44
MINTEX	MLB65
PAGID	8068
PFC	7765
WVA	20754 15,00

FCP845

WVA No: 21463 18,00

FMSI No: D292



100.0mm = 3.937"



65.0mm = 2.559"



18.0mm = 0.709"

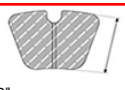

44.0mm = 1.732"

CITROEN Front, DACIA Front, PEUGEOT Front, RENAULT Front, RENAULT-ALPINE Front

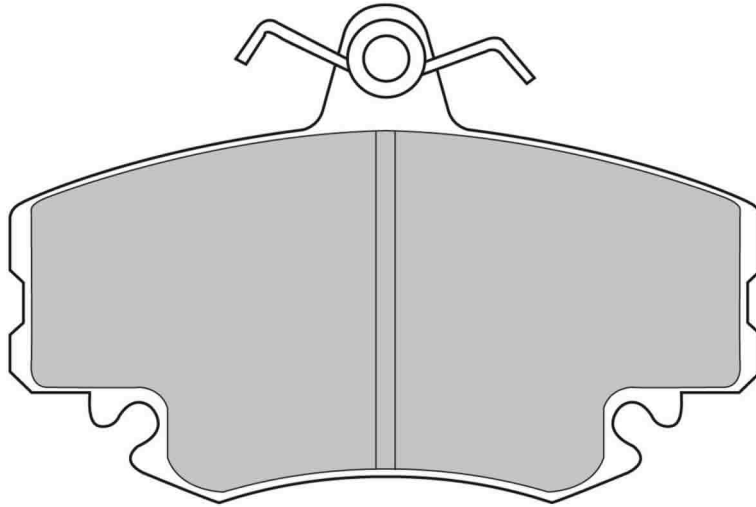

MATERIAL AVAILABILITY						
H	C	R	W	WB	Z	ZB
✓	✓	✓	✉			

CROSS REFERENCE	
ALCON	PNF0084X262.4
BREMBO	07.8301.35
CL BRAKES	4000
FMSI	D292
MINTEX	MDB1628
PAGID	3276
PFC	0292
WVA	21463 18,00

✓ Available ⚠ Exhausting
 ✗ Out of Range ✉ Make to order
 📅 In Introduction

FCP850

WVA No: 20180 16,80

FMSI No: D396



123.3mm = 4.854"



43.6mm = 1.717"



16.0mm = 0.630"



40.3mm = 1.587"

BMW Rear, CITROEN Rear, FIAT Rear, LANCIA Rear, PEUGEOT Rear

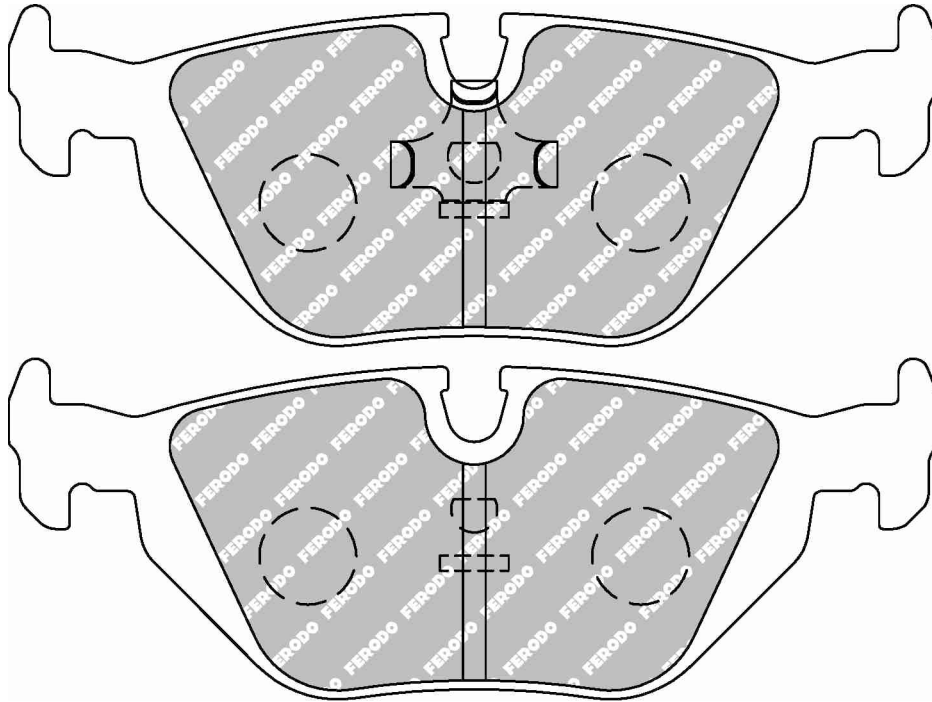

MATERIAL AVAILABILITY						
H	C	R	W	WB	Z	ZB
✓		✓	✓		✓	

CROSS REFERENCE	
BREMBO	07.8301.69
CL BRAKES	4032
FMSI	D396
FMSI	D692
FMSI	D763
HAWK	HB227 0,63
MINTEX	MDB1572
PAGID	8035
PFC	0396.XX
WVA	20180 16,80

FCP856

WVA No: 21284 19,30

FMSI No: D547

BMW Front, MASERATI Front



156.5mm = 6.161"



74.8mm = 2.945"



18.5mm = 0.728"



69.6mm = 2.740"

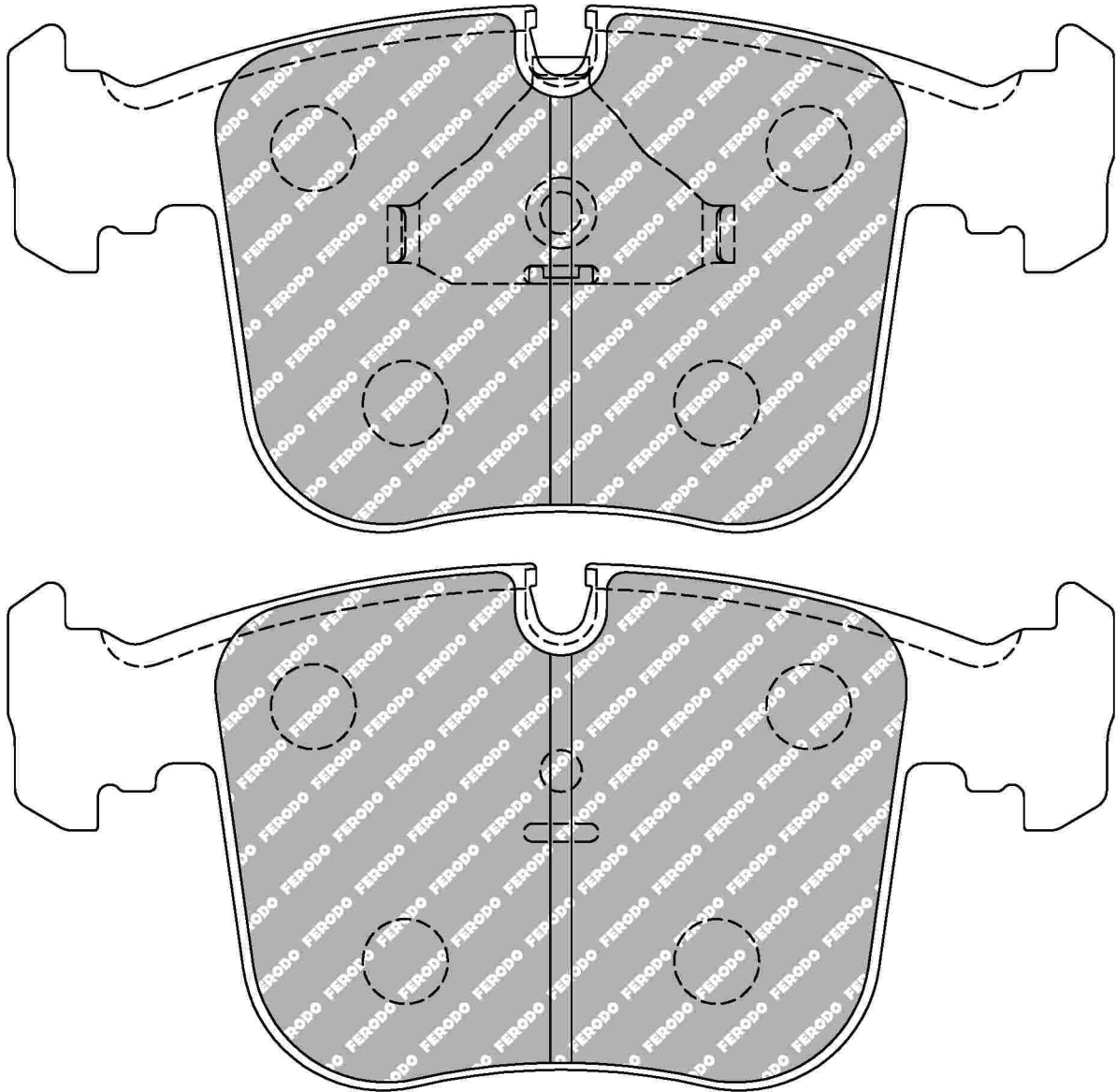

MATERIAL AVAILABILITY

H	C	R	W	WB	Z	ZB
✓		✉				

CROSS REFERENCE

BREMBO	07.8300.11
FMSI	D547
HAWK	HB325 0,72
MINTEX	MDB1551
PAGID	2683
WVA	21284 19,30

✓ Available ⚠ Exhausting
 ✗ Out of Range ✉ Make to order
 ⓘ In Introduction

FERODO
RACING
 Updated on 17th Aug 2018

3067

FCP857

WVA No: 21282 17,30

FMSI No: D548

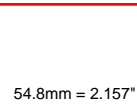
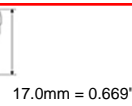
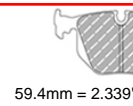
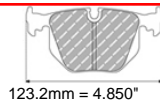

BMW Rear, MASERATI Rear

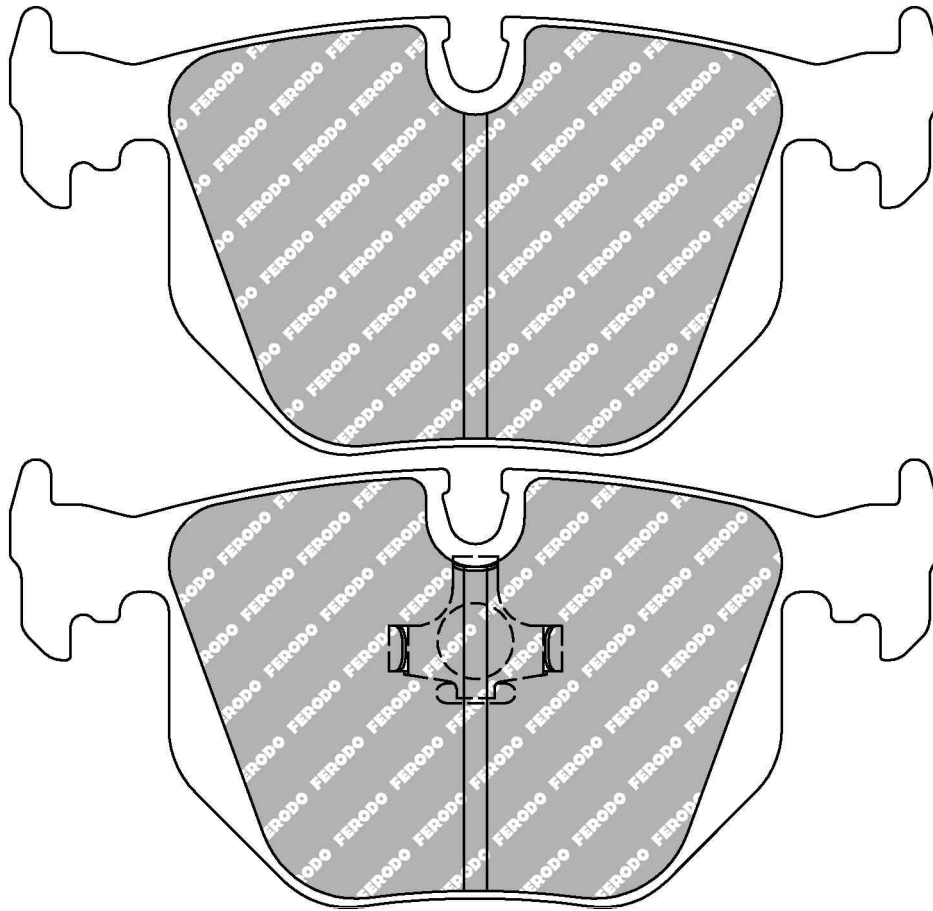

ALSO AVAILABLE		
SHAPE	TH. MM	NOTES
FCP1483	17.2	Different Spring Clip

MATERIAL AVAILABILITY						
H	C	R	W	WB	Z	ZB
✓		✓	✉			

CROSS REFERENCE	
ALCON	PNF0084X347.4
FMSI	D548
HAWK	HB362 0,642
MINTEX	MDB1552
PAGID	2685
WVA	21282 17,30

FCP859

WVA No: 21626 15,00



120.9mm = 4.760"



45.0mm = 1.772"



15.0mm = 0.591"



33.9mm = 1.335"

NISSAN Front

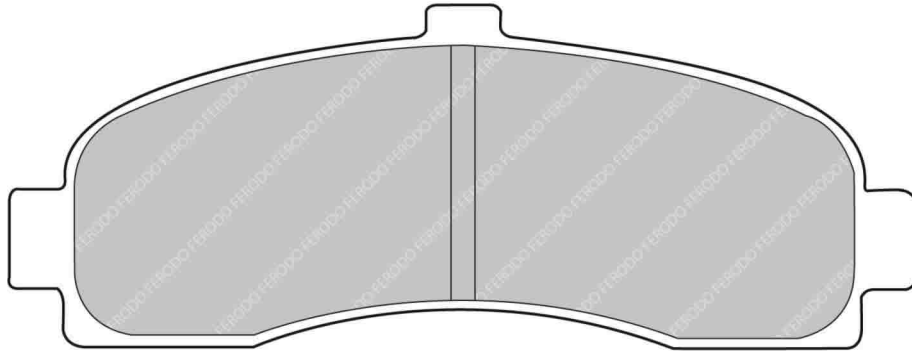

MATERIAL AVAILABILITY						
H	C	R	W	WB	Z	ZB

CROSS REFERENCE	
BREMBO	07.8301.36
MINTEX	MDB1623
WVA	21626 15,00

Available Exhausting
 Out of Range Make to order
 In Introduction

FCP867

WVA No: 21601 17,50

FMSI No: D562

TOYOTA Front



133.0mm = 5.236"



53.0mm = 2.087"



17.5mm = 0.689"

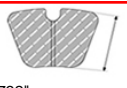

44.0mm = 1.732"

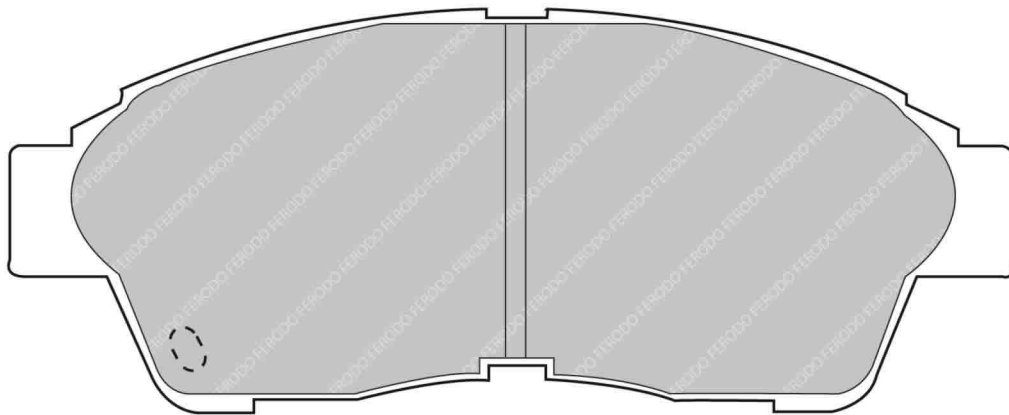
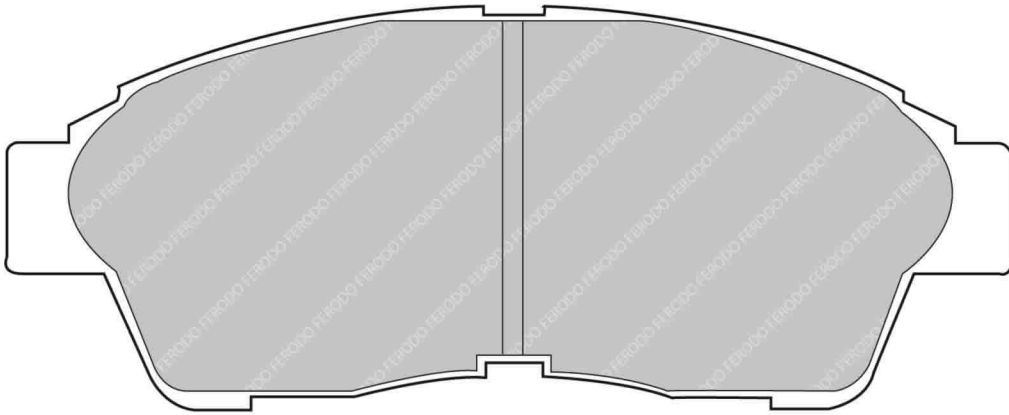

MATERIAL AVAILABILITY

H	C	R	W	WB	Z	ZB
✓						

CROSS REFERENCE

BREMBO	07.8300.12
FMSI	D562
FMSI	D695
HAWK	HB310 0,689
MINTEX	MDB1658
PFC	0562.XX
WVA	21601 17,50

FCP876

WVA No: 21430 17,30



141.5mm = 5.571"
140.3mm = 5.524"



47.8mm = 1.882"
47.8mm = 1.882"



16.5mm = 0.650"
16.5mm = 0.650"

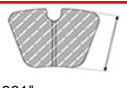

42.2mm = 1.661"
42.2mm = 1.661"

CITROEN Front, PEUGEOT Front

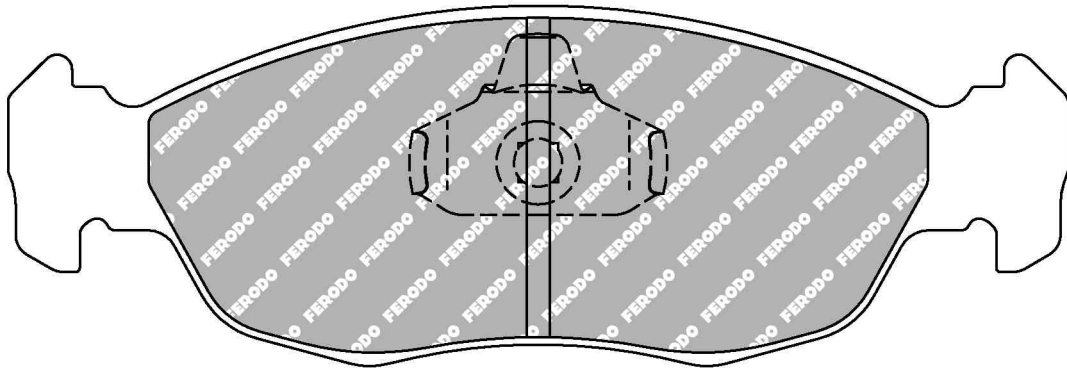
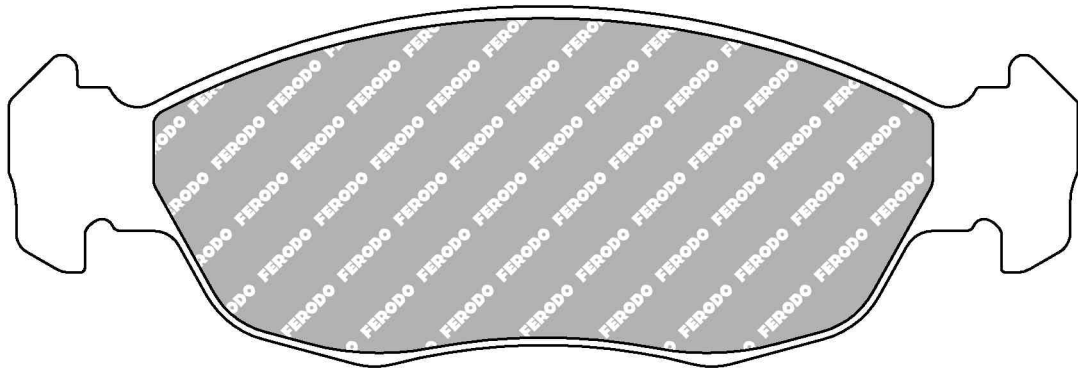

MATERIAL AVAILABILITY						
H	C	R	W	WB	Z	ZB
✓		✓				

CROSS REFERENCE	
BREMBO	07.8301.37
MINTEX	MDB1662
PAGID	1620
WVA	21430 17,30

- ✓ Available
- ✗ Out of Range
- ⓘ In Introduction
- ⚠ Exhausting
- 📦 Make to order

FCP878

WVA No: 20410 14,80

FMSI No: D491

DODGE Rear, RENAULT Rear

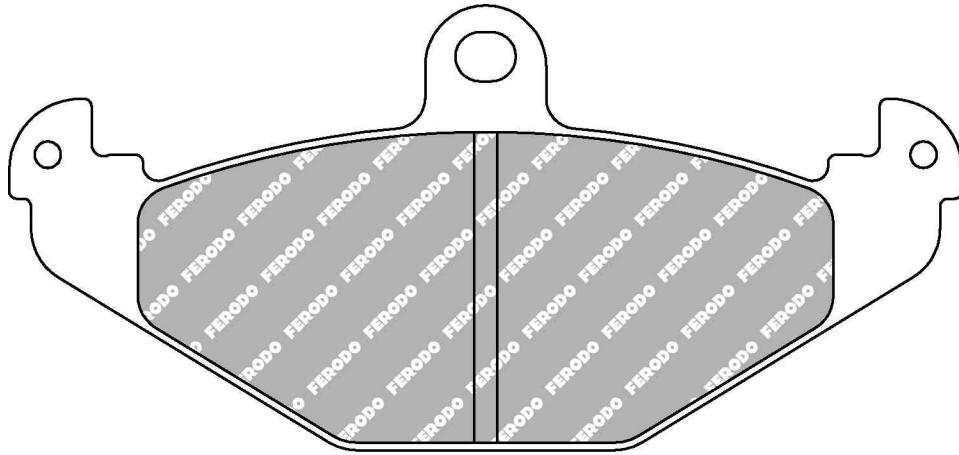
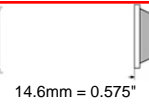
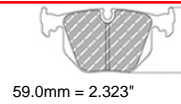
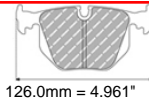

ALSO AVAILABLE		
SHAPE	TH. MM	NOTES
FCP1560	12.9	

MATERIAL AVAILABILITY						
H	C	R	W	WB	Z	ZB
✓		✓				

CROSS REFERENCE	
FMSI	D491
HAWK	HB278 0,583
MINTEX	MDB1445
PAGID	1682
PFC	0491
WVA	20410 14,80

FCP881

WVA No: 20634 15,00

FMSI No: D453

RENAULT Front

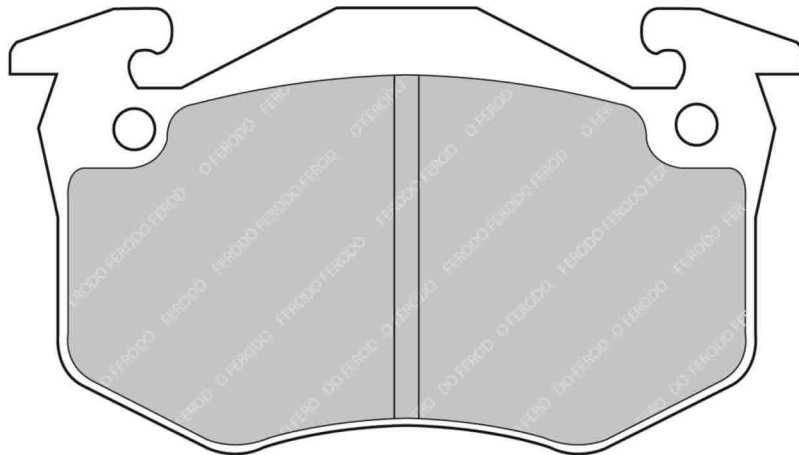
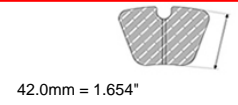
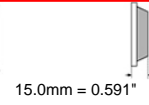
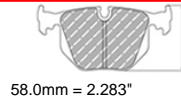
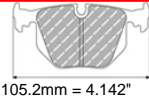

ALSO AVAILABLE		
SHAPE	TH. MM	NOTES
FCP558	11	

MATERIAL AVAILABILITY						
H	C	R	W	WB	Z	ZB
✉						

CROSS REFERENCE	
BREMBO	07.8301.38
CL BRAKES	4005
FMSI	D453
MINTEX	MDB1676
WVA	20634 15,00

FCP891

WVA No: 21402 17,50

FMSI No: D594

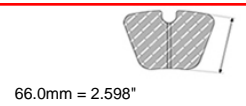
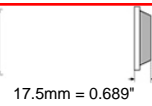
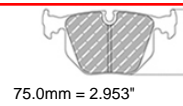
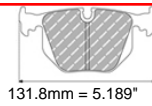

AUDI Front, PORSCHE Front

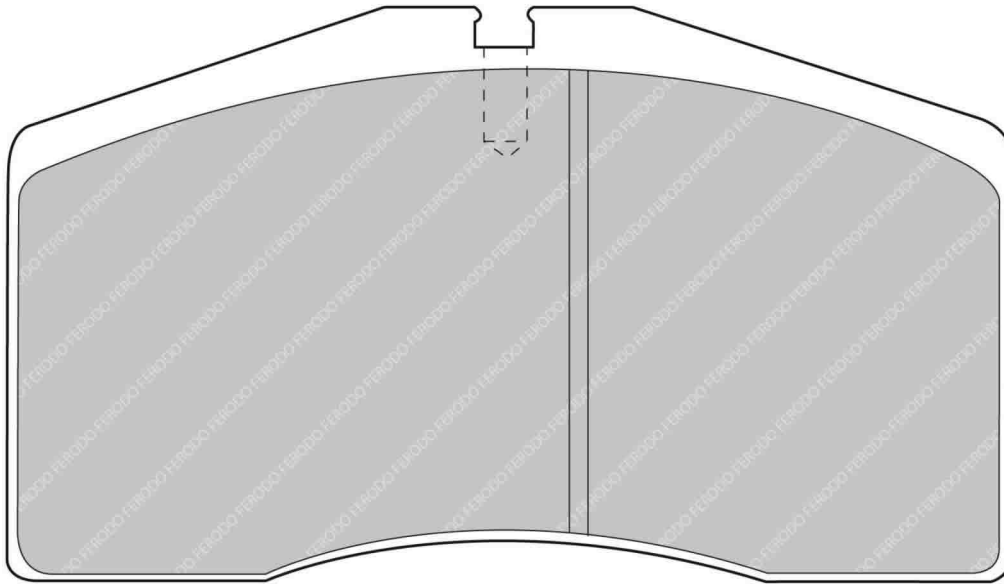

ALSO AVAILABLE		
SHAPE	TH. MM	NOTES
FRP3042	26.5	

MATERIAL AVAILABILITY						
H	C	R	W	WB	Z	ZB
✓		✓	✗			

CROSS REFERENCE	
CL BRAKES	4005
FMSI	D594
HAWK	HB184 .650A
MINTEX	MDB1860
PAGID	1842
PFC	0594.XX.18
WVA	21402 17,50

✓ Available ⚠ Exhausting
 ✗ Out of Range 📧 Make to order
 📌 In Introduction

FCP904

WVA No: 21497 18,50

FMSI No: D568

HONDA Front, ROVER Front



137.9mm = 5.429"



53.0mm = 2.087"



18.5mm = 0.728"

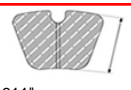

46.0mm = 1.811"

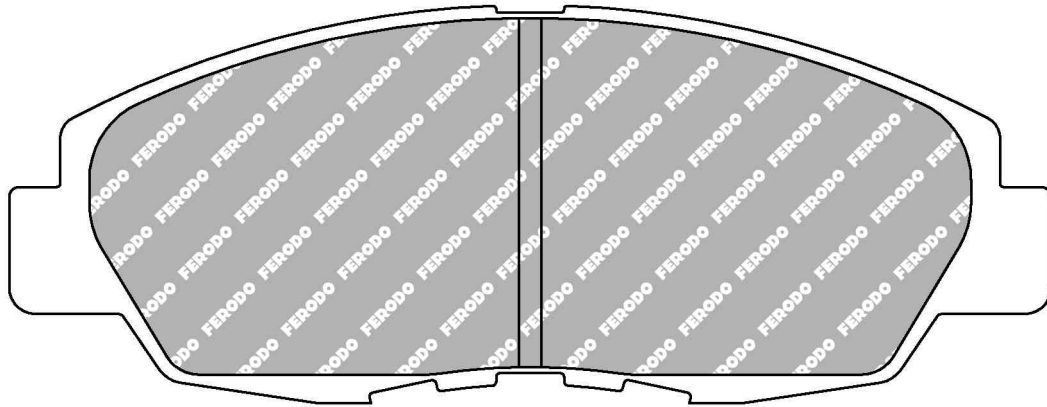

MATERIAL AVAILABILITY						
H	C	R	W	WB	Z	ZB
✓						

CROSS REFERENCE	
BREMBO	07.8300.27
FMSI	D568
HAWK	HB144 0,719
MINTEX	MDB1635
MINTEX	MDB1971
WVA	21497 18,50

FCP905

WVA No: 21651 18,50

FMSI No: D503

ACURA Front, HONDA Front, ROVER Front



148.8mm = 5.858"



57.0mm = 2.244"



18.5mm = 0.728"



50.5mm = 1.988"

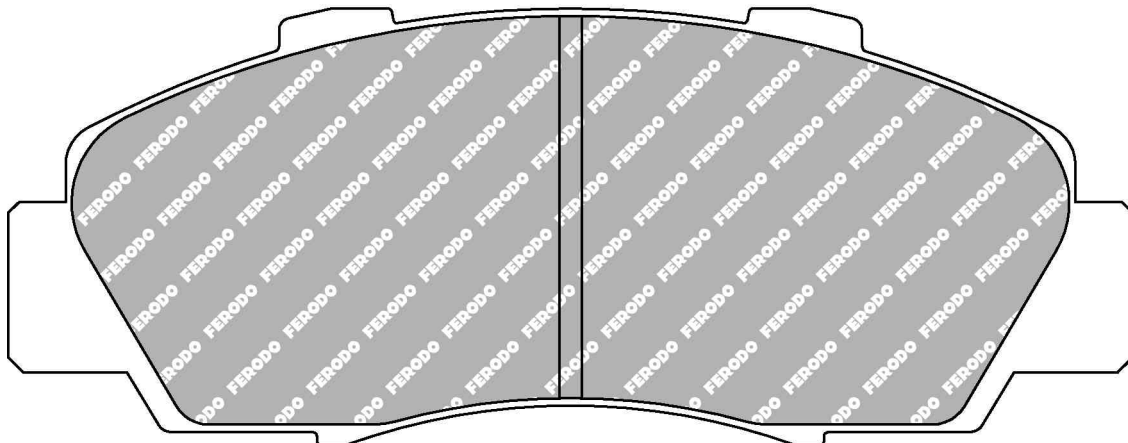

ALSO AVAILABLE		
SHAPE	TH. MM	NOTES
FRP3062	19.5	

MATERIAL AVAILABILITY						
H	C	R	W	WB	Z	ZB
✓		✓				

CROSS REFERENCE	
BREMBO	07.8300.00
CL BRAKES	4044
FMSI	D503
HAWK	HB143 0,68
MINTEX	MDB1543
PAGID	2623
PFC	0503.XX
WVA	21651 18,50

FCP925

WVA No: 21436 17,00



115.1mm = 4.531"



55.0mm = 2.165"



17.0mm = 0.669"

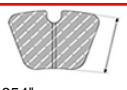

42.0mm = 1.654"

FIAT Front, FIAT AUTO POLAND Front, LANCIA Front

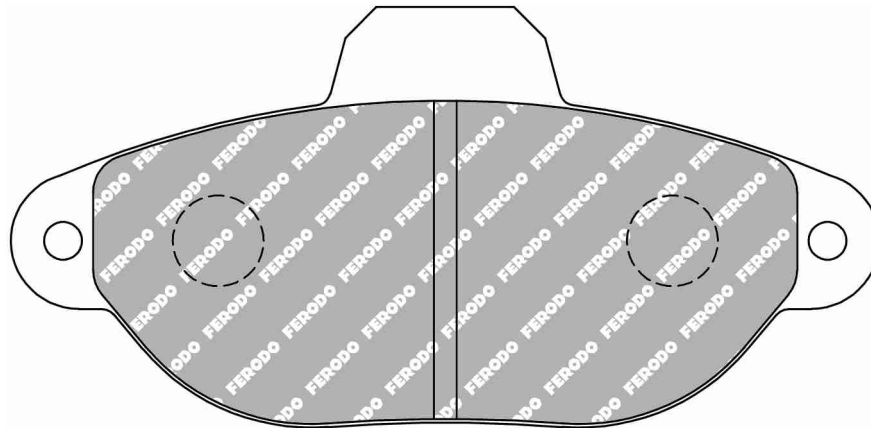

MATERIAL AVAILABILITY						
H	C	R	W	WB	Z	ZB
✓		✓				

CROSS REFERENCE	
BREMBO	07.8301.39
MINTEX	MDB1666
WVA	21436 17,00
WVA	21437 17,00

FCP948

WVA No: 21482 16,70

FMSI No: D563



128.0mm = 5.039"



58.0mm = 2.283"



16.7mm = 0.657"

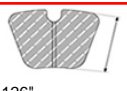

54.0mm = 2.126"

SUBARU Front

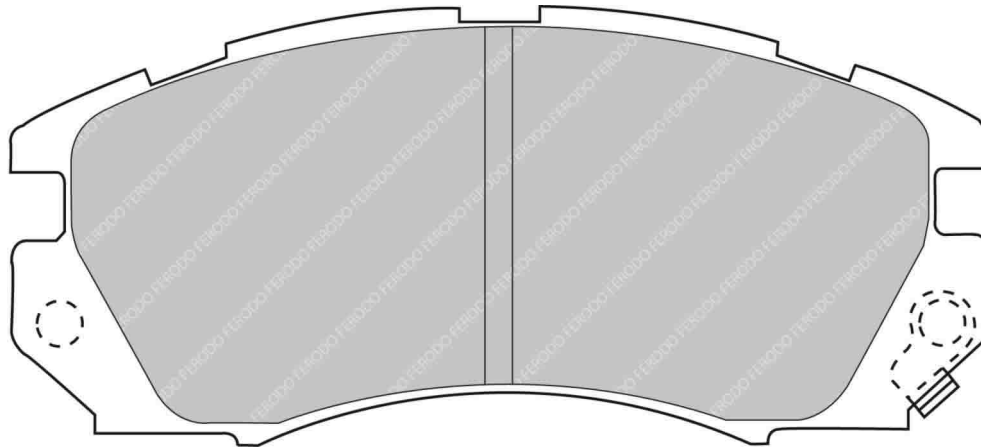

MATERIAL AVAILABILITY						
H	C	R	W	WB	Z	ZB
✓		✓				

CROSS REFERENCE	
FMSI	D563
MINTEX	MDB1688
WVA	21482 16,70

- ✓ Available
- ✗ Out of Range
- ⚠ Exhausting
- 📦 Make to order
- 👤 In Introduction

FCP956

WVA No: 21719 14,50



88.8mm = 3.496"



47.5mm = 1.870"



14.4mm = 0.567"

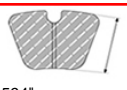

40.5mm = 1.594"

HONDA Rear, MG Rear, ROVER Rear, SUZUKI Rear

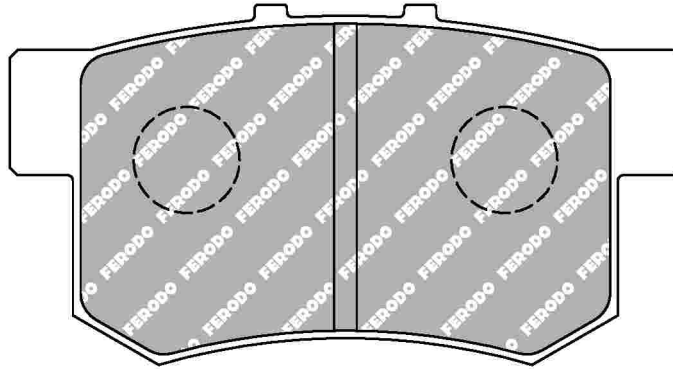

MATERIAL AVAILABILITY						
H	C	R	W	WB	Z	ZB
✓		✓	✗			

CROSS REFERENCE	
MINTEX	MDB1564
PFC	0537
WVA	21719 14,50

FCP986

WVA No: 21307 14,50

FMSI No: D460



119.3mm = 4.697"



62.0mm = 2.441"



14.5mm = 0.571"



49.5mm = 1.949"

NISSAN Front, SUBARU Front

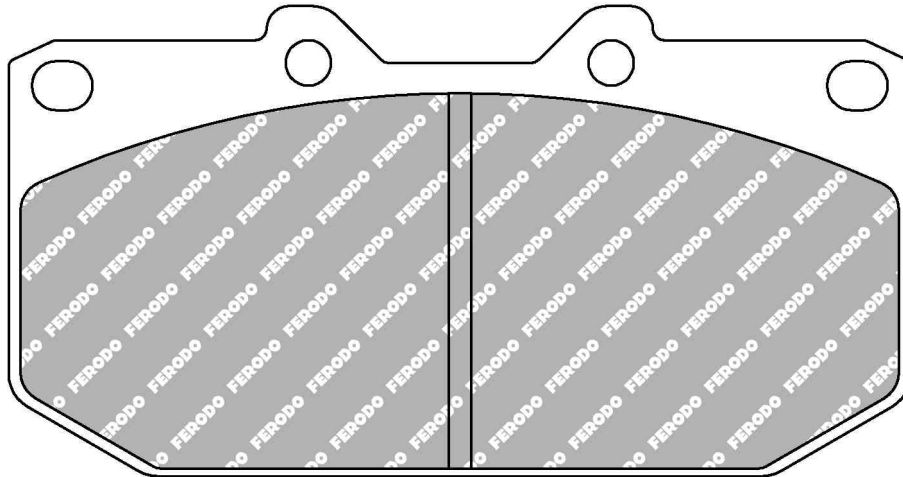

MATERIAL AVAILABILITY						
H	C	R	W	WB	Z	ZB
✓		✓	✗		✓	

CROSS REFERENCE	
ALCON	PNF0084X249.4
BREMBO	07.8300.15
FMSI	D460
FMSI	D647
HAWK	HB178 0,564
MINTEX	MDB1416
PAGID	1406
PFC	0460
PFC	0460.XX
WVA	21307 14,50

FCP995

WVA No: 21606 16,20



90.0mm = 3.543"



54.0mm = 2.126"



16.4mm = 0.646"

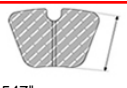

39.3mm = 1.547"

ALFA ROMEO Rear, LANCIA Rear

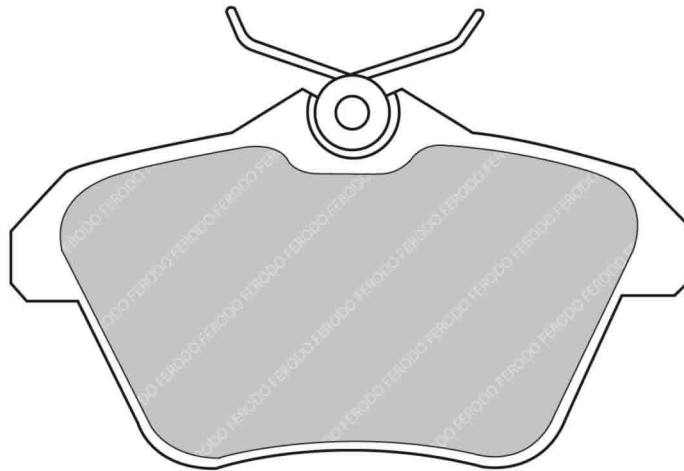

MATERIAL AVAILABILITY						
H	C	R	W	WB	Z	ZB
✓						

CROSS REFERENCE	
MINTEX	MDB1742
WVA	21606 16,20

FCP997

FMSI No: D681

ALPINA Front, BMW Front



156.0mm = 6.142"



74.0mm = 2.913"



18.0mm = 0.709"

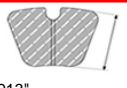

74.0mm = 2.913"

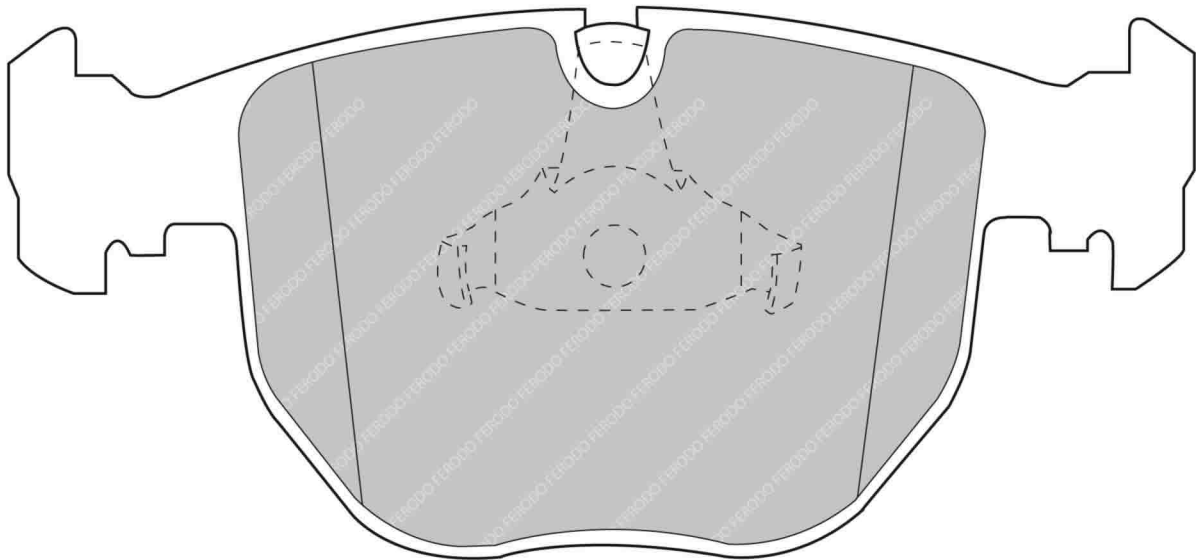

MATERIAL AVAILABILITY						
H	C	R	W	WB	Z	ZB
✓		✉				

CROSS REFERENCE	
FMSI	D681
HAWK	HB497 0,776
MINTEX	MDB1745
PAGID	2683
PFC	0682.XX

- ✓ Available
- ✗ Out of Range
- ✉ In Introduction
- ⚠ Exhausting
- ✉ Make to order

FCP1001

WVA No: 21484 20,00

FMSI No: D682



194.6mm = 7.661"



74.0mm = 2.913"



20.8mm = 0.819"

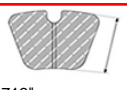

68.9mm = 2.713"

AUDI Front, BMW Front, CHRYSLER Front, MERCEDES Front, VOLKSWAGEN Front

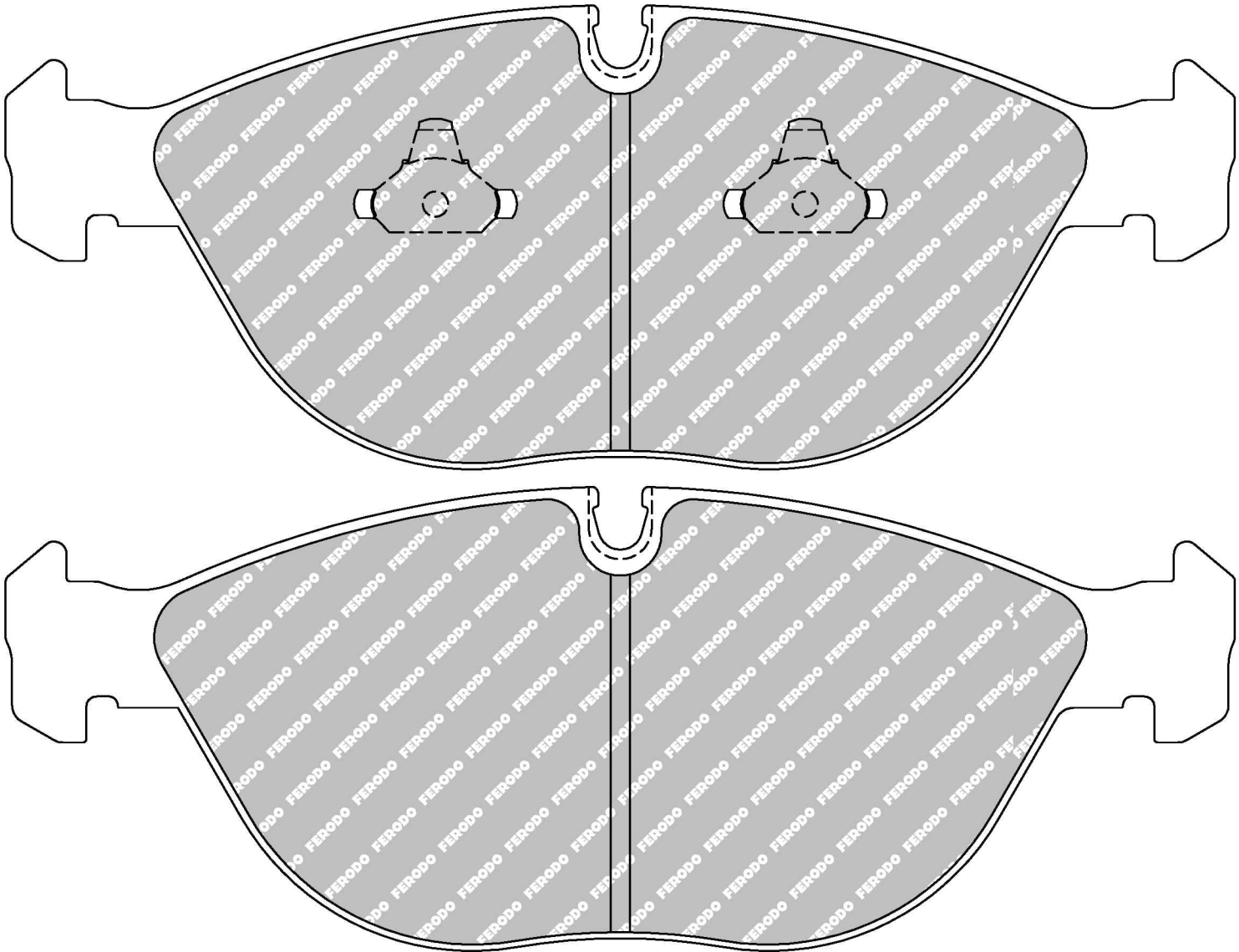

clip design indicative only

MATERIAL AVAILABILITY						
H	C	R	W	WB	Z	ZB
✓					✓	

CROSS REFERENCE	
FMSI	D682
MINTEX	MDB1746
PAGID	2830
WVA	21484 20,00

3078



RACING

Updated on 17th Aug 2018

- ✓ Available
- ✗ Out of Range
- 🔧 In Introduction
- ⚠ Exhausting
- 📦 Make to order

FCP1011

WVA No: 23354 13,00

FMSI No: D635



110.1mm = 4.335"

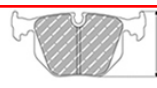

61.0mm = 2.402"



12.9mm = 0.508"



52.5mm = 2.067"

MAZDA Front

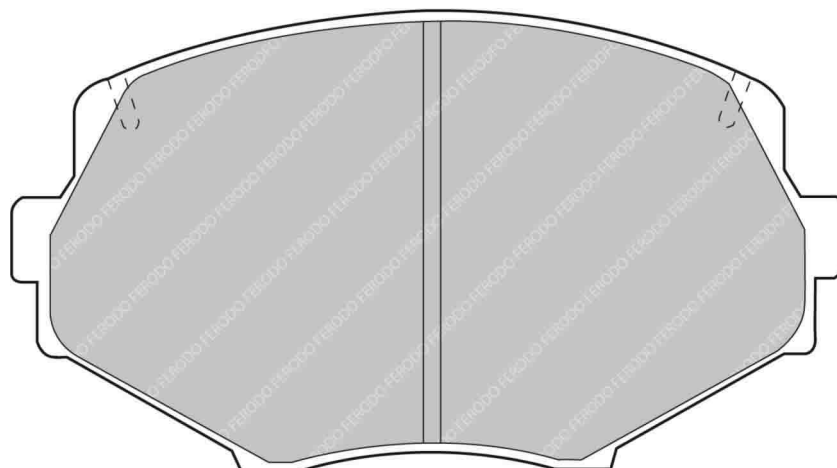

MATERIAL AVAILABILITY						
H	C	R	W	WB	Z	ZB
✓		✘				

CROSS REFERENCE	
CL BRAKES	4107
FMSI	D635
HAWK	HB149 0,505
MINTEX	MDB1686
PAGID	8127
WVA	23354 13,00

FCP1012

WVA No: 23387 12,50

FMSI No: D636

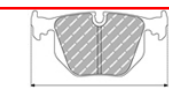

102.0mm = 4.016"

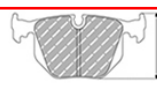

43.0mm = 1.693"



13.0mm = 0.512"

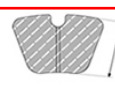

30.3mm = 1.193"

MAZDA Rear

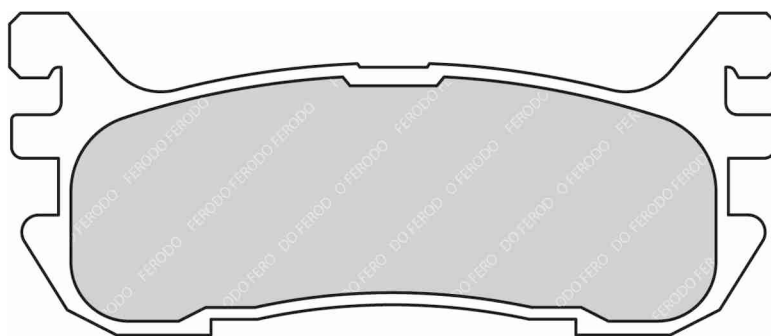

MATERIAL AVAILABILITY						
H	C	R	W	WB	Z	ZB
✓						

CROSS REFERENCE	
CL BRAKES	4106
FMSI	D636
HAWK	HB159 0,492
MINTEX	MDB1705
MINTEX	MDB1893
PAGID	8129
WVA	23387 12,50

✓ Available ⚠ Exhausting
 ✘ Out of Range 📦 Make to order
 📌 In Introduction

FCP1021

WVA No: 21947



116mm = 4.567"



44.3mm = 1.744"



15.5mm = 0.610"



33.9mm = 1.335"

LEXUS Rear, MITSUBISHI Rear, TOYOTA Rear

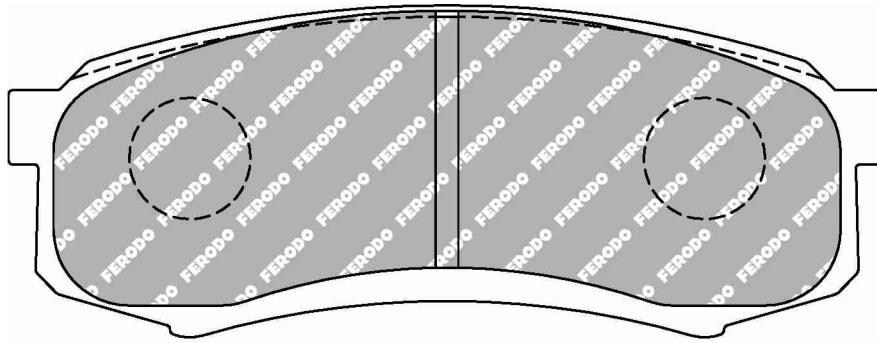

MATERIAL AVAILABILITY						
H	C	R	W	WB	Z	ZB
✓						

CROSS REFERENCE	
BREMBO	P83 024
WVA	21947

FCP1049

WVA No: 21664 19,00



151.6mm = 5.969"
151.6mm = 5.969"



66.2mm = 2.606"
60.0mm = 2.362"



19.1mm = 0.752"
19.1mm = 0.752"

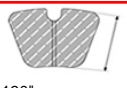

54.1mm = 2.130"
54.1mm = 2.130"

MERCEDES Front

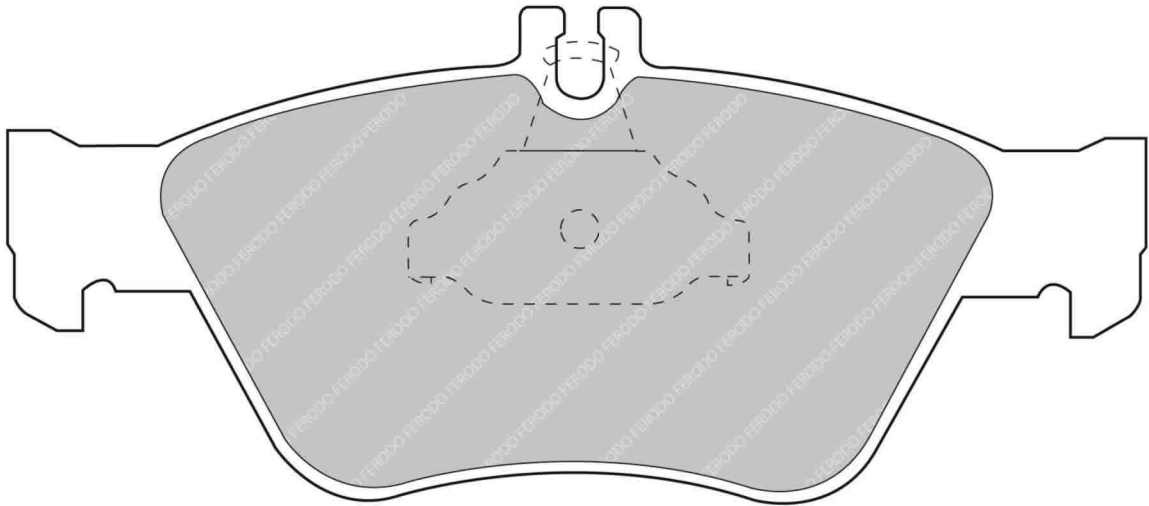

MATERIAL AVAILABILITY						
H	C	R	W	WB	Z	ZB
✓						

CROSS REFERENCE	
BREMBO	07.8301.41
MINTEX	MDB1736
WVA	21664 19,00

✓ Available ⚠ Exhausting
 ✗ Out of Range 📦 Make to order
 📌 In Introduction

FCP1050

WVA No: 21670 19,50

FMSI No: D740

CHRYSLER Front, MERCEDES Front



156.5mm = 6.161"
156.5mm = 6.161"



69.5mm = 2.736"
66.9mm = 2.634"



20.4mm = 0.803"
20.4mm = 0.803"

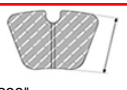

58.4mm = 2.299"
58.4mm = 2.299"

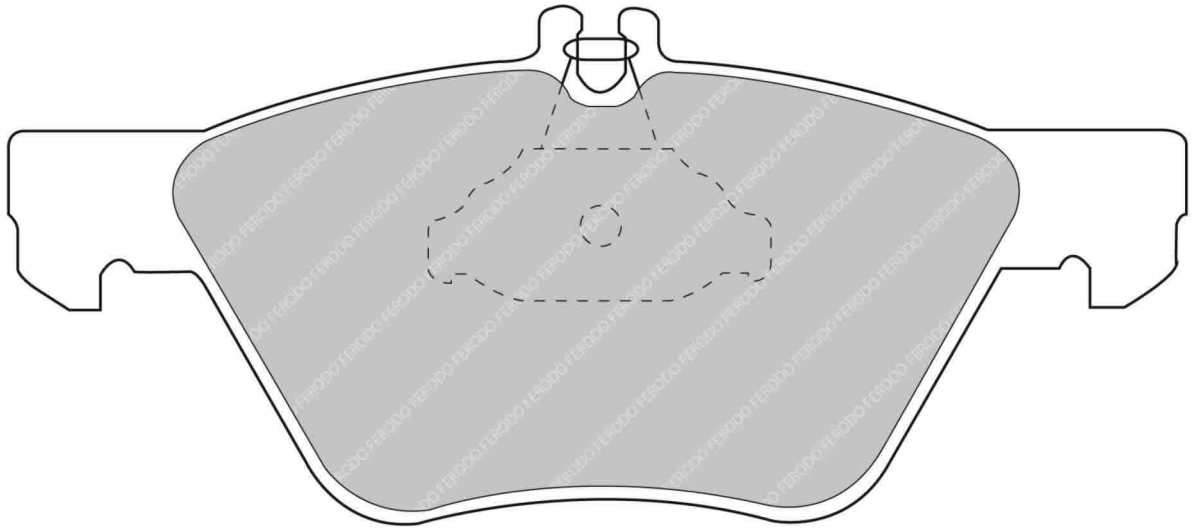

MATERIAL AVAILABILITY						
H	C	R	W	WB	Z	ZB
✓						

CROSS REFERENCE	
BREMBO	07.8301.42
FMSI	D740
HAWK	HB495 0,756
MINTEX	MDB1871
WVA	21670 19,50

FCP1052

WVA No: 21636 18,00



155.2mm = 6.110"
156.4mm = 6.157"



61.7mm = 2.429"
58.9mm = 2.319"



18.5mm = 0.728"
18.5mm = 0.728"

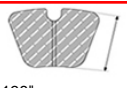

54.3mm = 2.138"
54.3mm = 2.138"

ALFA ROMEO Front, FIAT Front, LANCIA Front

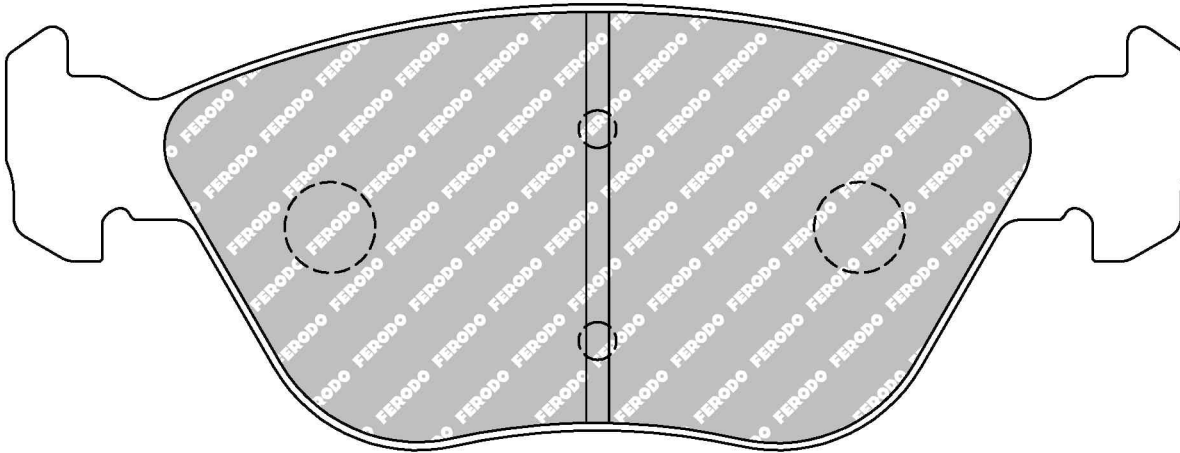
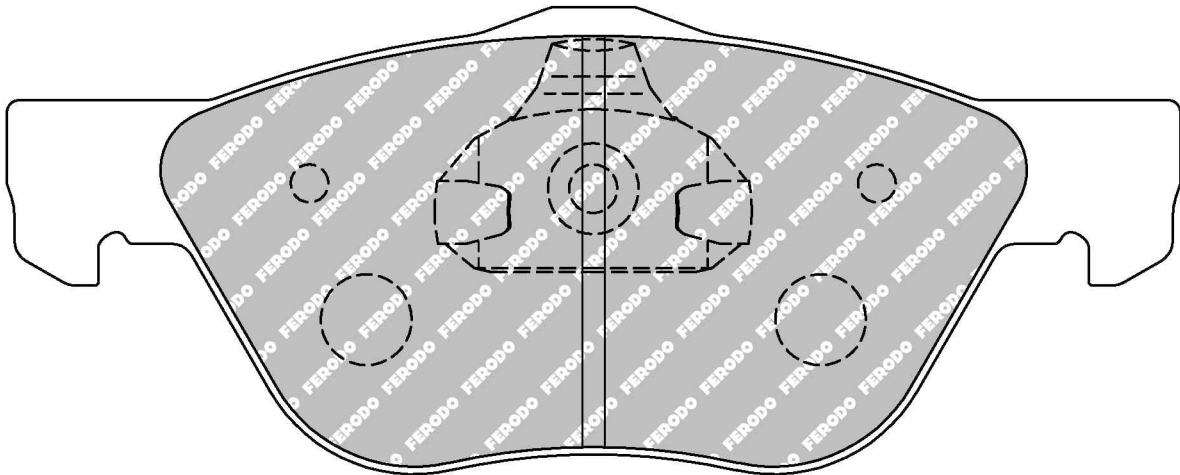

MATERIAL AVAILABILITY						
H	C	R	W	WB	Z	ZB
✓		✓				

CROSS REFERENCE	
BREMBO	07.8301.43
MINTEX	MDB1735
MINTEX	MDB2068
WVA	21636 18,00

✓ Available ⚠ Exhausting
 ✗ Out of Range 📦 Make to order
 📌 In Introduction

FCP1054

WVA No: 21866 19,70



141.8mm = 5.583"
141.8mm = 5.583"



48.0mm = 1.890"
50.6mm = 1.992"



19.3mm = 0.760"
19.3mm = 0.760"

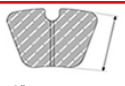

45.0mm = 1.772"
45.0mm = 1.772"

SEAT Front, VOLKSWAGEN Front

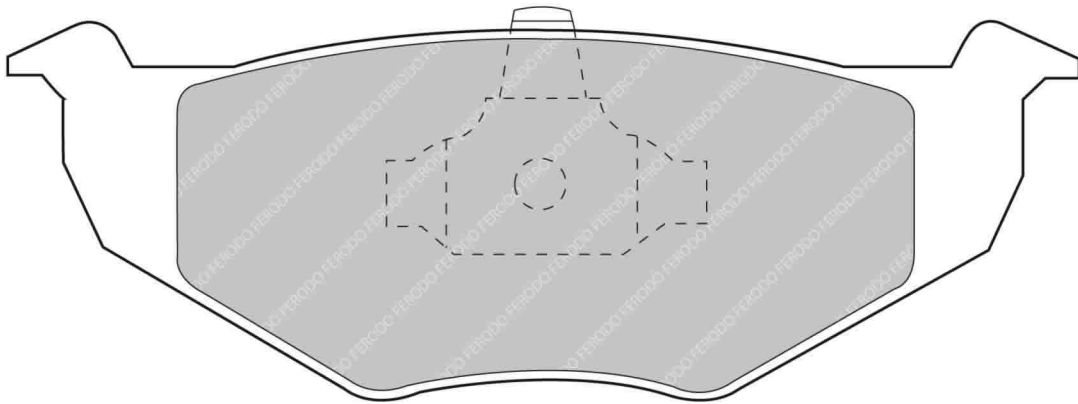
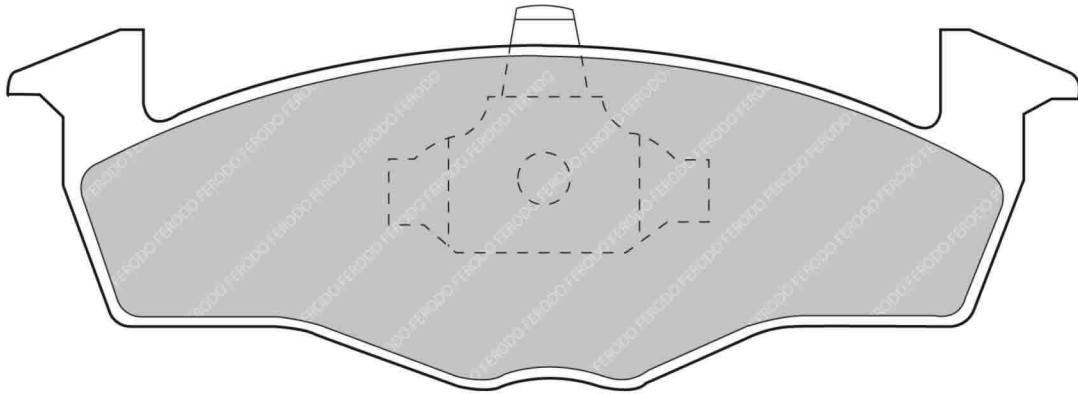

ALSO AVAILABLE		
SHAPE	TH. MM	NOTES
FCP1101	17.3	
FCP1288	15.3	

CROSS REFERENCE	
MINTEX	MDB1804
WVA	21866 19,70

MATERIAL AVAILABILITY						
H	C	R	W	WB	Z	ZB
✓						

FCP1056

WVA No: 21927 17,00



156.4mm = 6.157"



52.5mm = 2.067"



17.9mm = 0.705"

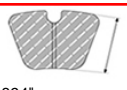

48.1mm = 1.894"

ALFA ROMEO Front, FIAT Front, LANCIA Front

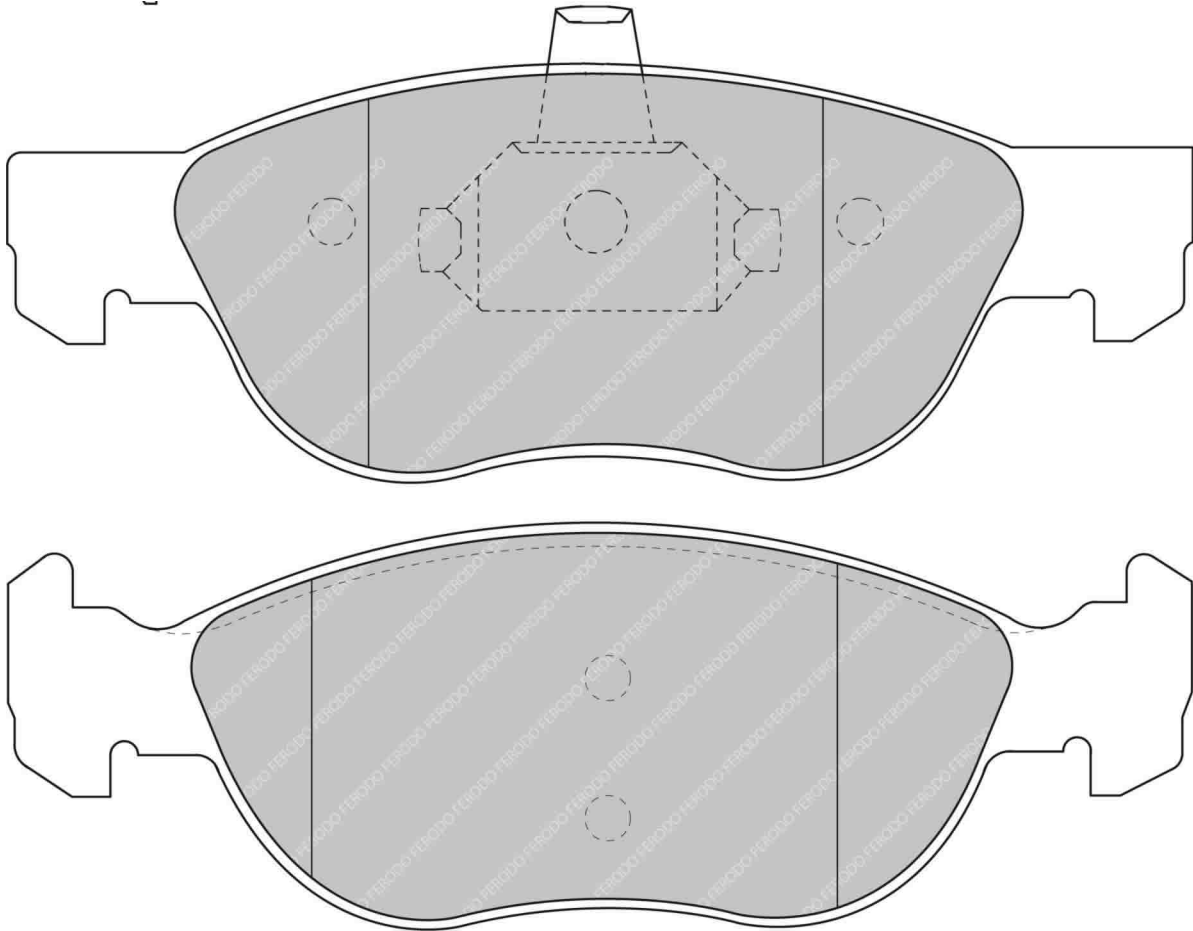

MATERIAL AVAILABILITY

H	C	R	W	WB	Z	ZB
✓						

CROSS REFERENCE

BREMBO	07.8301.45
MINTEX	MDB1734
WVA	21927 17,00

✓ Available ⚠ Exhausting
 ✗ Out of Range 📦 Make to order
 📅 In Introduction

FERODO
RACING
 Updated on 17th Aug 2018

3085

FCP1063

WVA No: 21674 18,00



130.0mm = 5.118"



57.0mm = 2.244"



18.5mm = 0.728"



49.4mm = 1.945"

BMW Front, CITROEN Front, PEUGEOT Front

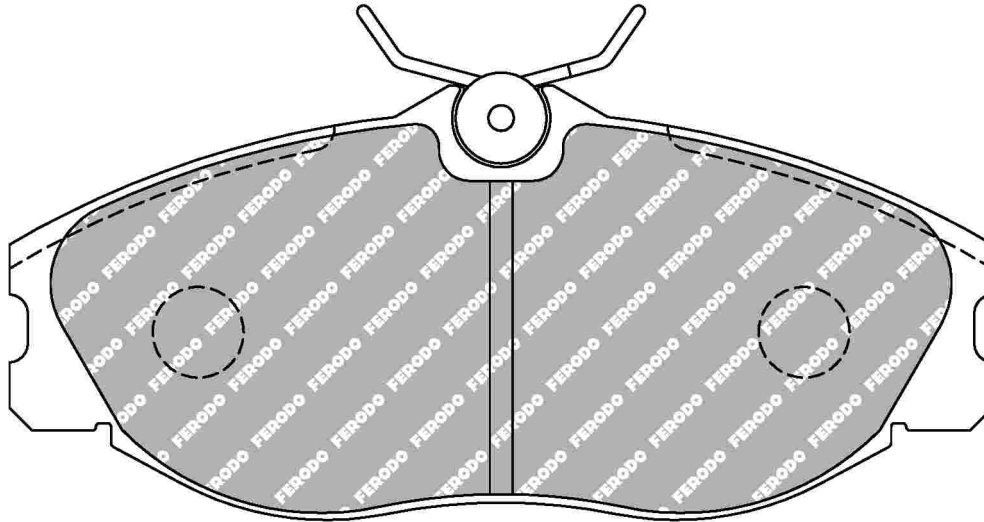

MATERIAL AVAILABILITY						
H	C	R	W	WB	Z	ZB
✓		✓				

CROSS REFERENCE	
BREMBO	07.8301.00
BREMBO	07.8301.46
MINTEX	MDB1732
WVA	21674 18,00

FCP1068

WVA No: 21829 19,50

FMSI No: D819

OPEL Front, SAAB Front, VAUXHALL Front



156.5mm = 6.161"
155.2mm = 6.110"



74.0mm = 2.913"
74.0mm = 2.913"



19.5mm = 0.768"
19.5mm = 0.768"

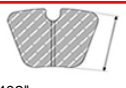

61.0mm = 2.402"
61.0mm = 2.402"

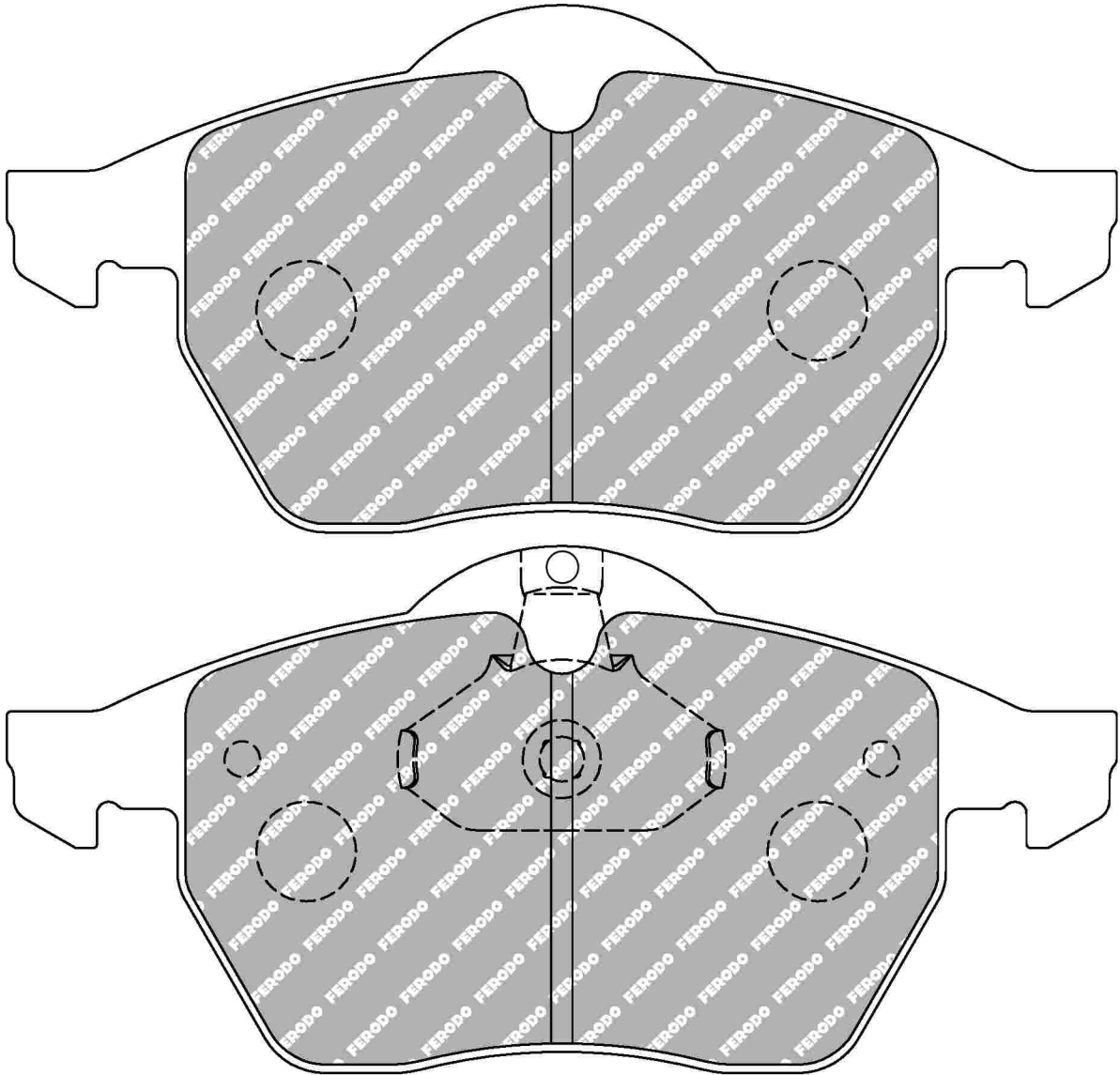

MATERIAL AVAILABILITY						
H	C	R	W	WB	Z	ZB
✓						

CROSS REFERENCE	
BREMBO	07.8301.48
CL BRAKES	4031
FMSI	D819
HAWK	HB388 0,756
MINTEX	MDB1813
PAGID	2275
WVA	21829 19,50

✓ Available ⚠ Exhausting
 ✗ Out of Range 📦 Make to order
 📅 In Introduction

FCP1073

WVA No: 21677 19,50

FMSI No: D946



156.5mm = 6.161"
156.5mm = 6.161"



63.9mm = 2.516"
63.9mm = 2.516"



20.2mm = 0.795"
20.2mm = 0.795"

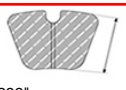

58.4mm = 2.299"
58.4mm = 2.299"

BMW Front

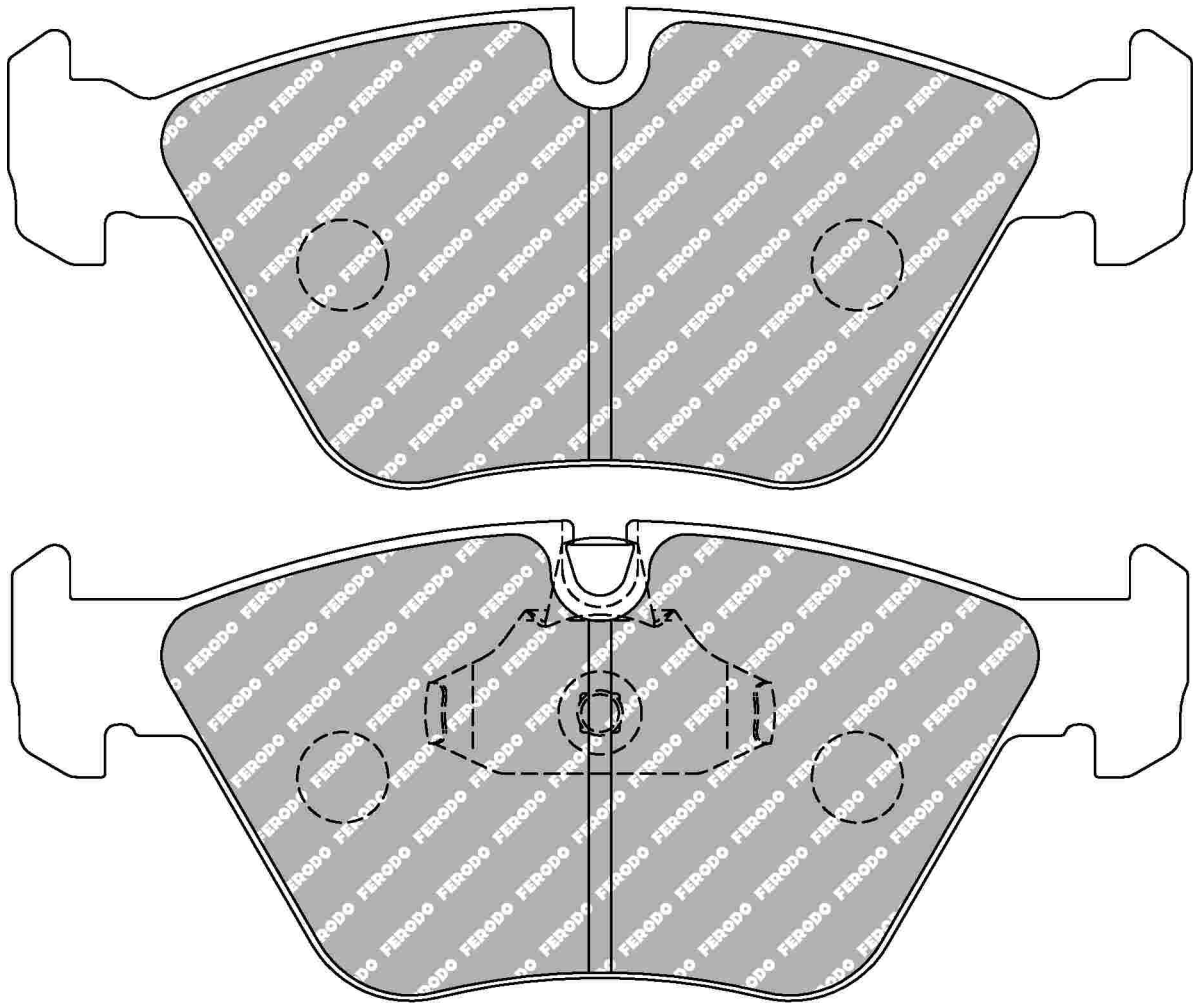

MATERIAL AVAILABILITY						
H	C	R	W	WB	Z	ZB
✓			✓		✉	

CROSS REFERENCE	
CL BRAKES	4033
FMSI	D946
HAWK	HB464 0,764
MINTEX	MDB1817
WVA	21677 19,50

FCP1081

WVA No: 23103-23104 18,00

FMSI No: D350

FORD Front, MAZDA Front

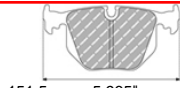

151.5mm = 5.965"



46.5mm = 1.831"



18.0mm = 0.709"

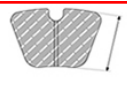

39.1mm = 1.539"

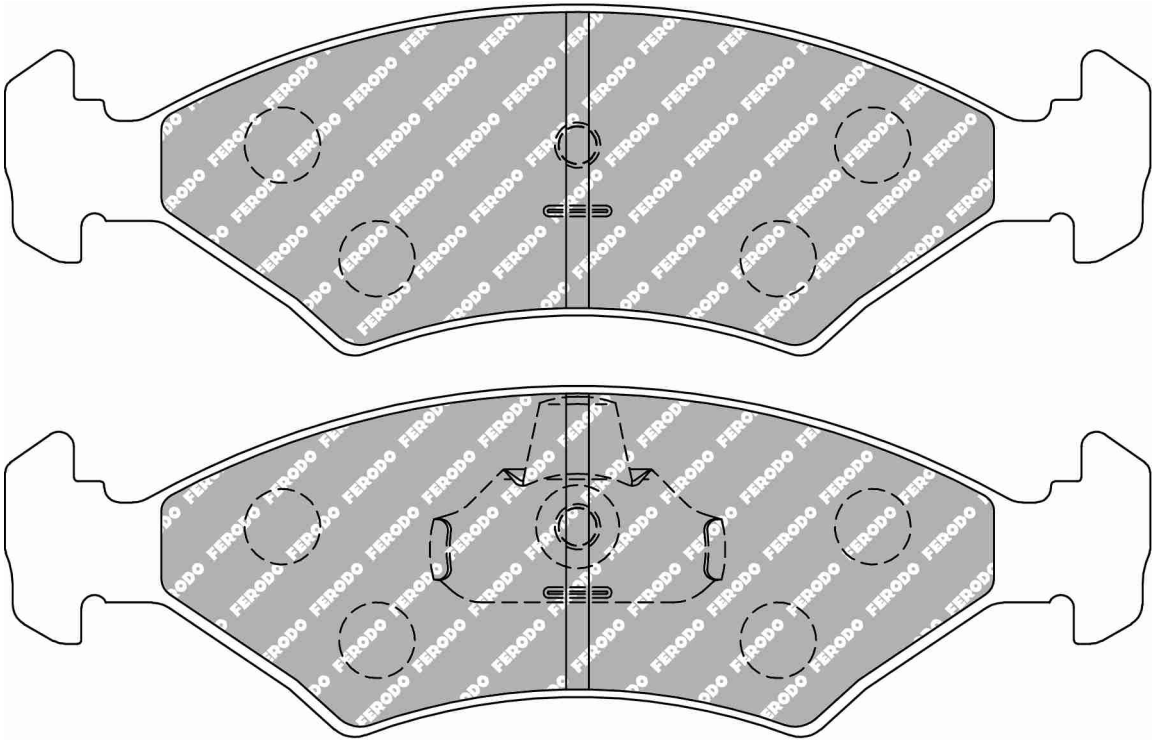

MATERIAL AVAILABILITY						
H	C	R	W	WB	Z	ZB
✓		✓				

CROSS REFERENCE	
ALCON	PNF0084X325.4
BREMBO	07.8301.51
FMSI	D350
MINTEX	MDB1883
MINTEX	MDB2110
WVA	23103-23104 18,00

✓ Available ⚠ Exhausting
 ✗ Out of Range 📦 Make to order
 📌 In Introduction

FCP1082

WVA No: 23101 18,00



141.5mm = 5.571"



45.0mm = 1.772"



17.5mm = 0.689"

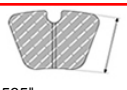

39.0mm = 1.535"

FORD Front, MAZDA Front

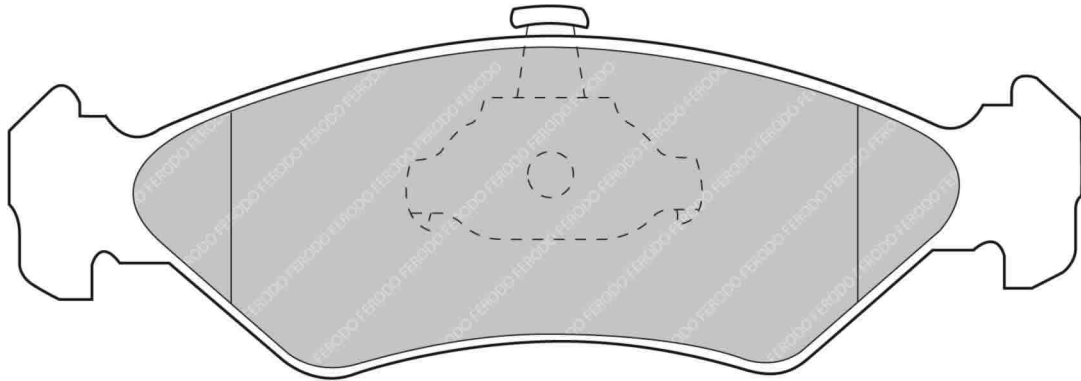

MATERIAL AVAILABILITY						
H	C	R	W	WB	Z	ZB
✓		✉				

CROSS REFERENCE	
BREMBO	07.8301.52
MINTEX	MDB1884
WVA	23101 18,00

FCP1093

WVA No: 21920 15,60

FMSI No: D837



130.1mm = 5.122"



72.8mm = 2.866"



14.5mm = 0.571"

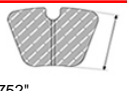

44.5mm = 1.752"

mitsubishi Front, volvo Front

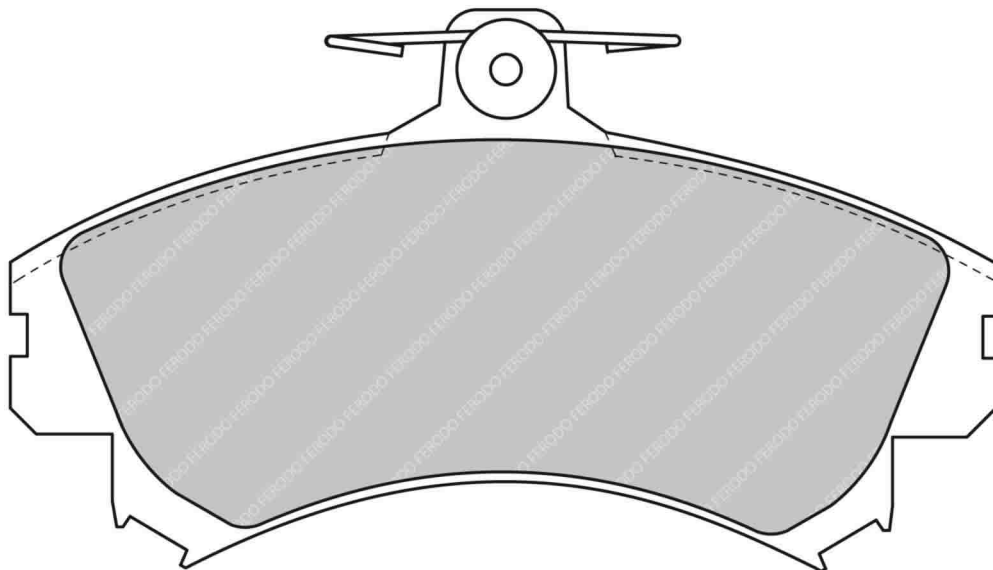

MATERIAL AVAILABILITY						
H	C	R	W	WB	Z	ZB
✓		✗				

CROSS REFERENCE	
BREMBO	07.8301.53
FMSI	D837
HAWK	HB500 0,645
MINTEX	MDB1727
WVA	21920 15,60

FCP1094

WVA No: 21974 19,40

FMSI No: D768



146.4mm = 5.764"



55.2mm = 2.173"



19.7mm = 0.776"



50.1mm = 1.972"

AUDI Front, PORSCHE Front, SEAT Front, SKODA Front, VOLKSWAGEN Front

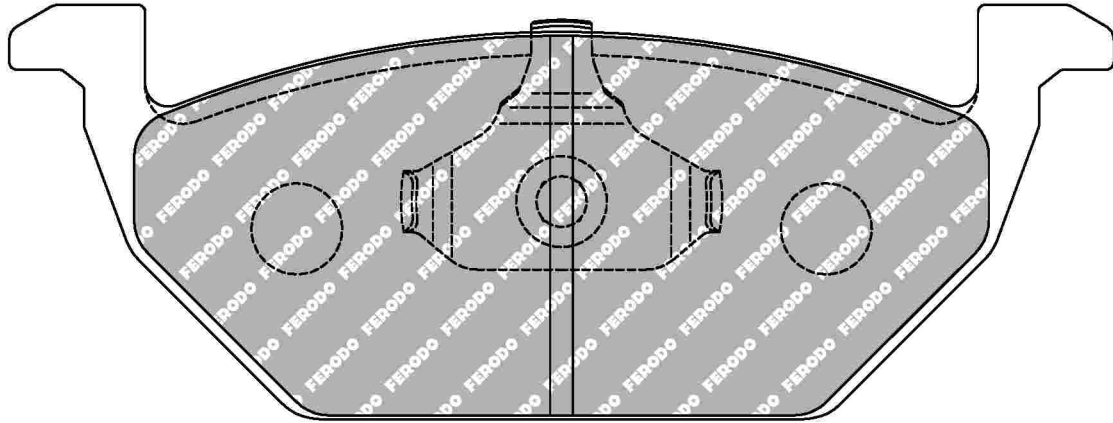

MATERIAL AVAILABILITY

H	C	R	W	WB	Z	ZB
✓		✉			✉	

CROSS REFERENCE

BREMBO	07.8300.04
CL BRAKES	4088
FMSI	D768
HAWK	HB365 0,728
MINTEX	MDB1811
MINTEX	MDB2034
WVA	21974 19,40

✓ Available ⚠ Exhausting
 ✗ Out of Range ✉ Make to order
 ⓘ In Introduction

FCP1101

WVA No: 21866 17,30

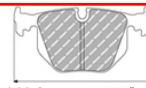

141.6mm = 5.575"
141.6mm = 5.575"



50.3mm = 1.980"
51.2mm = 2.016"



17.3mm = 0.681"
17.3mm = 0.681"

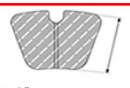

45.0mm = 1.772"
45.0mm = 1.772"

SEAT Front, SKODA Front, VOLKSWAGEN Front

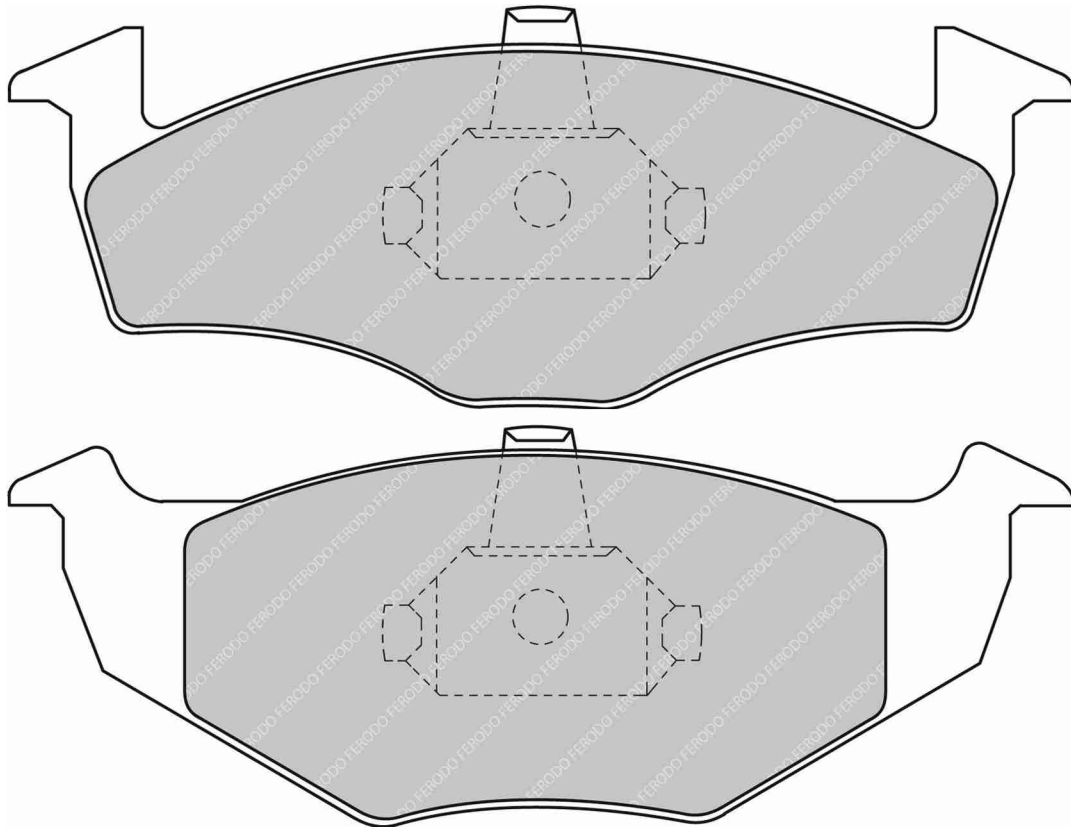

ALSO AVAILABLE

SHAPE	TH. MM	NOTES
FCP1054	19.3	
FCP1288	15.3	

MATERIAL AVAILABILITY

H	C	R	W	WB	Z	ZB

CROSS REFERENCE

BREMBO	07.8301.44
BREMBO	07.8301.54
MINTEX	MDB1805
WVA	21866 17,30

FCP1112

WVA No: 23124 19,00



130.0mm = 5.118"



56.0mm = 2.205"



18.0mm = 0.709"

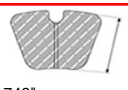

44.4mm = 1.748"

CITROEN Front, PEUGEOT Front

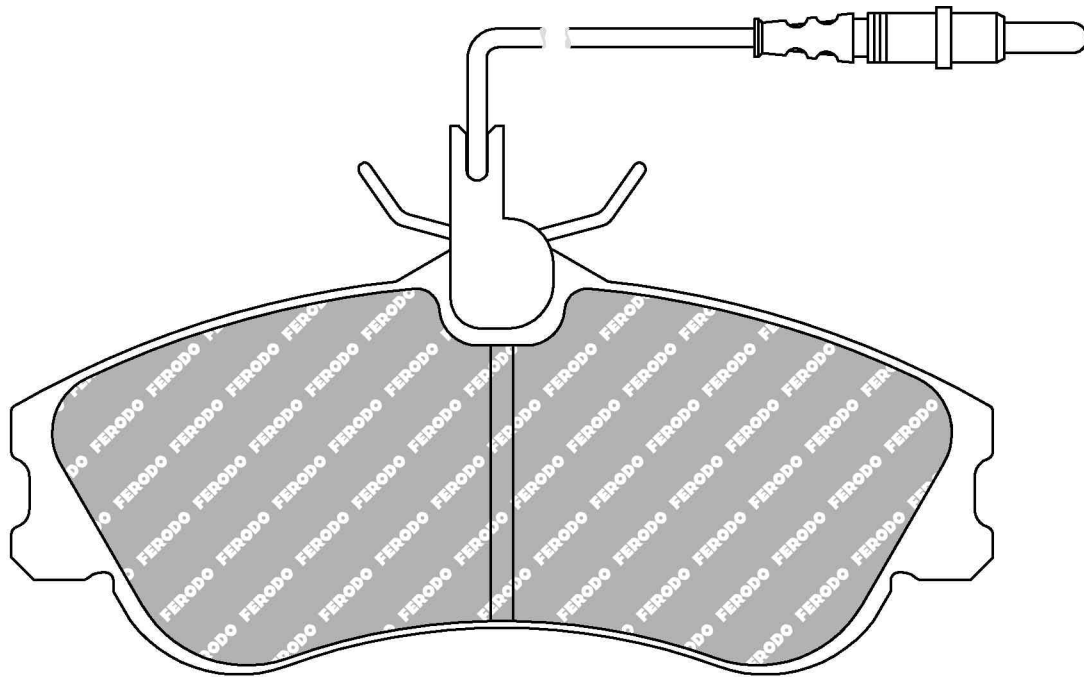

MATERIAL AVAILABILITY						
H	C	R	W	WB	Z	ZB
✓						

CROSS REFERENCE	
MINTEX	MDB1812
WVA	23124 19,00

FCP1113

WVA No: 23177 14,30



88.0mm = 3.465"



44.5mm = 1.752"



14.4mm = 0.567"

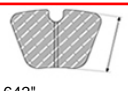

41.7mm = 1.642"

ALFA ROMEO Rear, FIAT Rear, LANCIA Rear

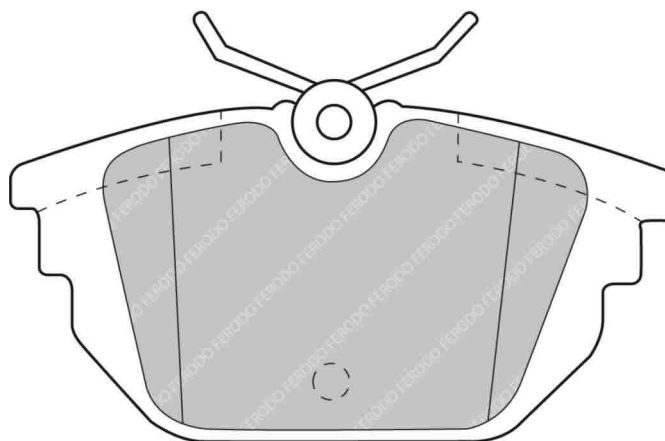

MATERIAL AVAILABILITY						
H	C	R	W	WB	Z	ZB
✓		✓				

CROSS REFERENCE	
BREMBO	07.8301.55
MINTEX	MDB1309
MINTEX	MDB1876
WVA	23177 14,30

- ✓ Available
- ✗ Out of Range
- ⓘ In Introduction
- ⚠ Exhausting
- 📦 Make to order

FCP1133

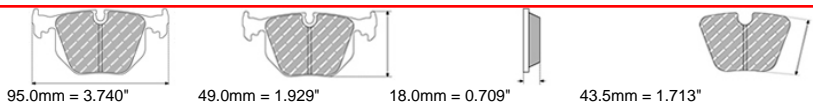

FMSI No: D278

CITROEN Front, PEUGEOT Front

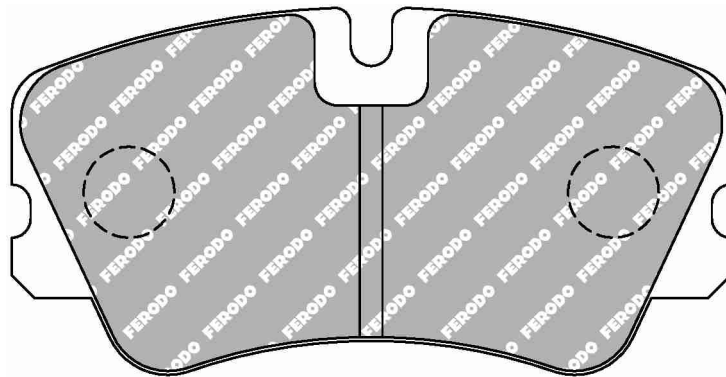

MATERIAL AVAILABILITY						
H	C	R	W	WB	Z	ZB
✓	✗	✓				

CROSS REFERENCE	
ALCON	PNF0084X299.4
BREMBO	07.8301.56
CL BRAKES	4020
FMSI	D278
FMSI	D439
FMSI	D493
HAWK	HB195 0,64
PAGID	2388
PFC	0278.XX

FCP1134

WVA No: 23140 19,30



156.5mm = 6.161"
155.3mm = 6.114"



63.8mm = 2.512"
59.3mm = 2.335"



18.5mm = 0.728"
18.5mm = 0.728"

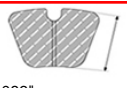

52.9mm = 2.083"
52.9mm = 2.083"

ALFA ROMEO Front

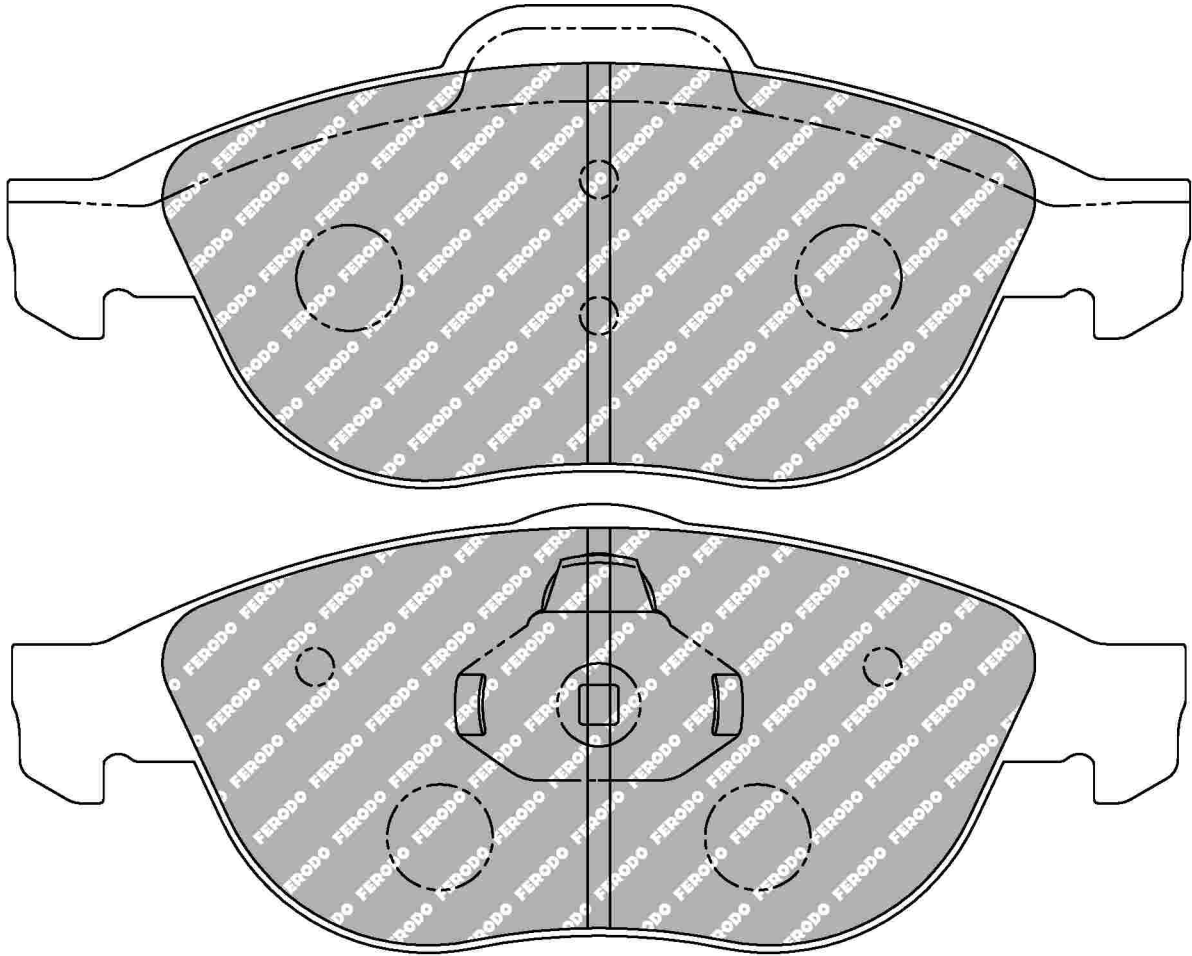

MATERIAL AVAILABILITY						
H	C	R	W	WB	Z	ZB
✓		✗				

CROSS REFERENCE	
BREMBO	07.8301.57
MINTEX	MDB1934
MINTEX	MDB2132
WVA	23140 19,30

✓ Available ⚠ Exhausting
 ✗ Out of Range 📦 Make to order
 📌 In Introduction

FCP1160

WVA No: 21931 17,00



151.4mm = 5.961"



52.0mm = 2.047"



17.1mm = 0.673"

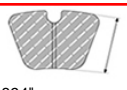

48.1mm = 1.894"

FIAT Front, LANCIA Front

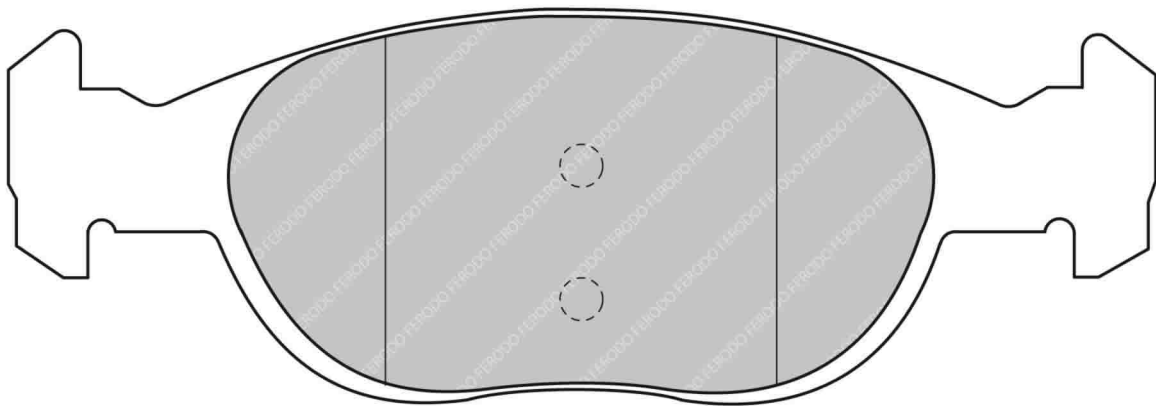
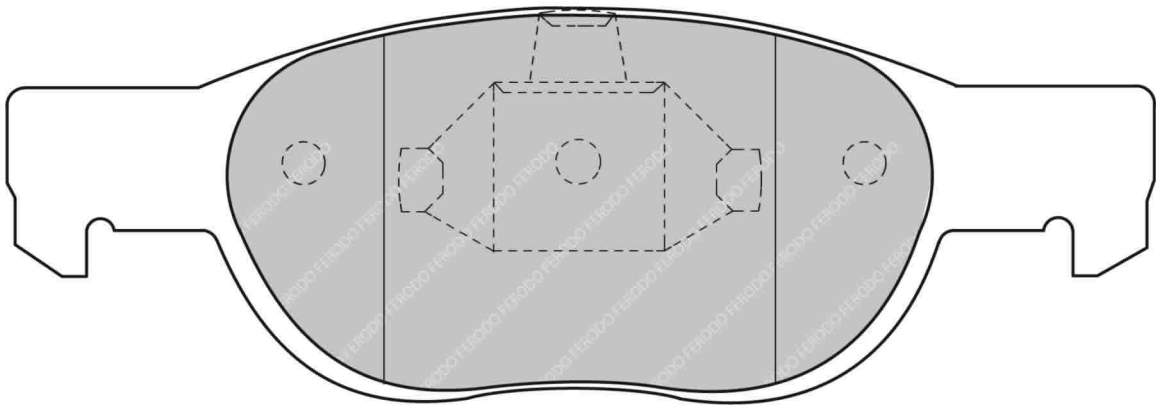

MATERIAL AVAILABILITY

H	C	R	W	WB	Z	ZB
✓						

CROSS REFERENCE

BREMBO	07.8301.59
MINTEX	MDB1828
MINTEX	MDB1956
MINTEX	MDB2206
WVA	21931 17,00

FCP1162

WVA No: 21998 15,60



90.1mm = 3.547"



70.0mm = 2.756"



15.0mm = 0.591"

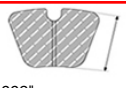

50.6mm = 1.992"

SMART (until 2002 MCC) Front

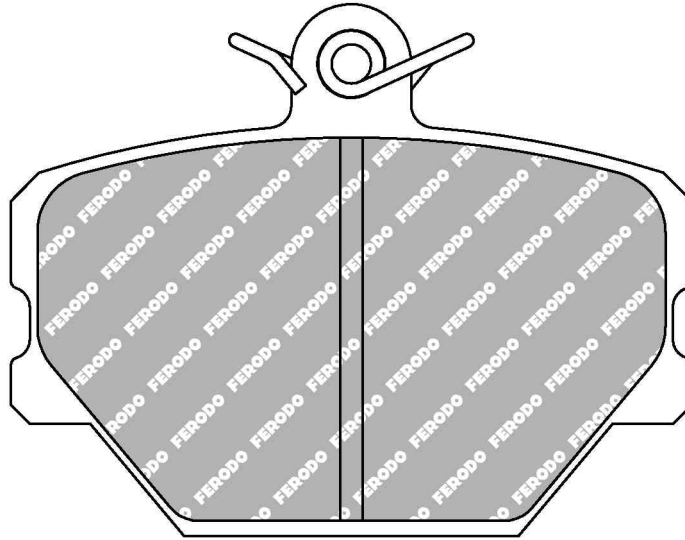

MATERIAL AVAILABILITY						
H	C	R	W	WB	Z	ZB
✓						

CROSS REFERENCE	
BREMBO	07.8301.60
MINTEX	MDB2033
WVA	21998 15,60

✓ Available ⚠ Exhausting
 ✗ Out of Range 📦 Make to order
 📌 In Introduction

FCP1213



147.7mm = 5.815"
125.3mm = 4.933"



58.6mm = 2.307"
76.2mm = 3.000"



15.7mm = 0.618"
16.6mm = 0.654"



39.8mm = 1.567"
45.3mm = 1.783"

FMSI No: D369

CADILLAC Front

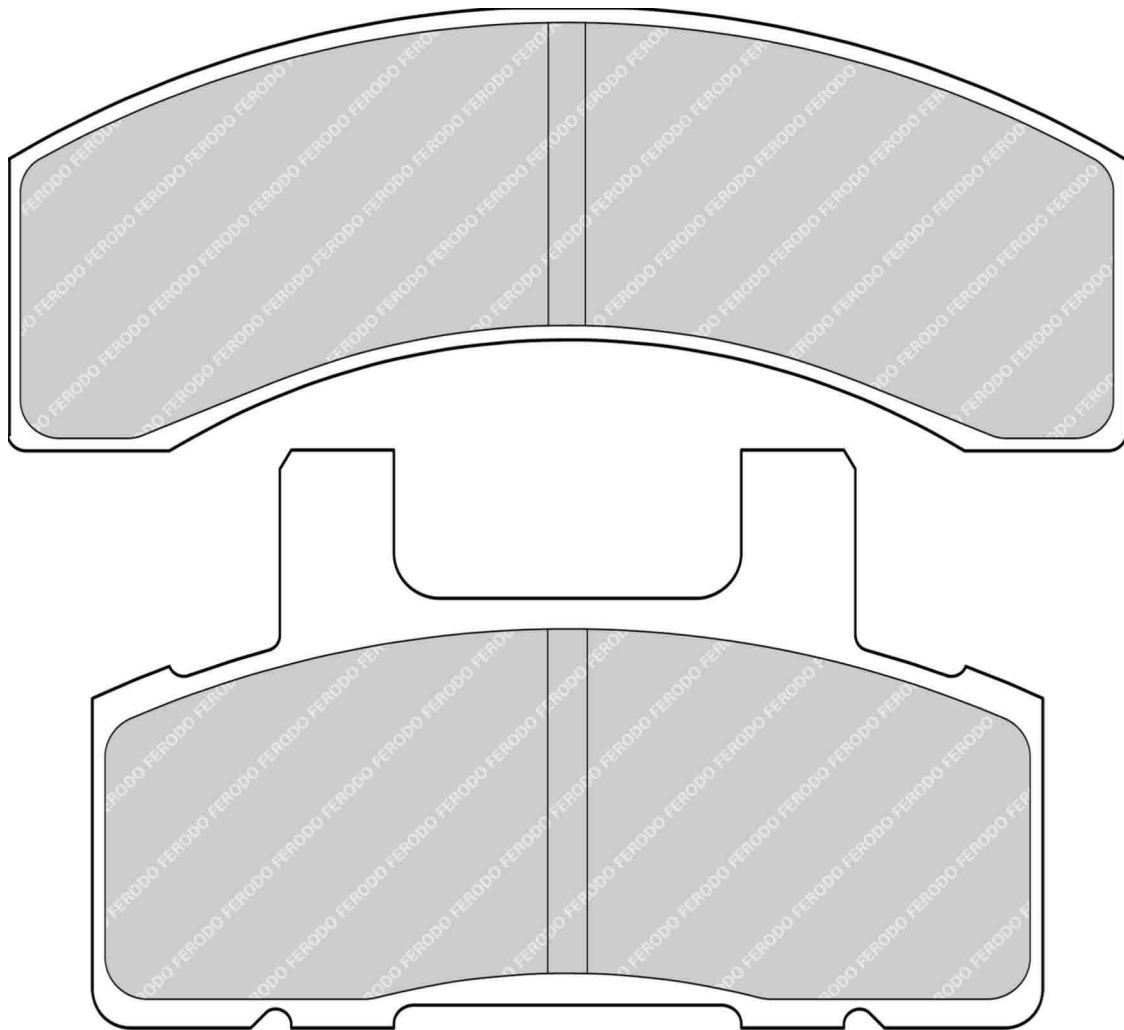

MATERIAL AVAILABILITY						
H	C	R	W	WB	Z	ZB

CROSS REFERENCE	
BREMBO	07.8300.24
FMSI	D369
HAWK	HB332 0,654
PFC	0369.XX

FCP1224



171.5mm = 6.752"



52.2mm = 2.055"



15.4mm = 0.606"



39.0mm = 1.535"

FMSI No: D412

ASTON MARTIN Front, CHEVROLET Front, FORD USA Front, PONTIAC Front

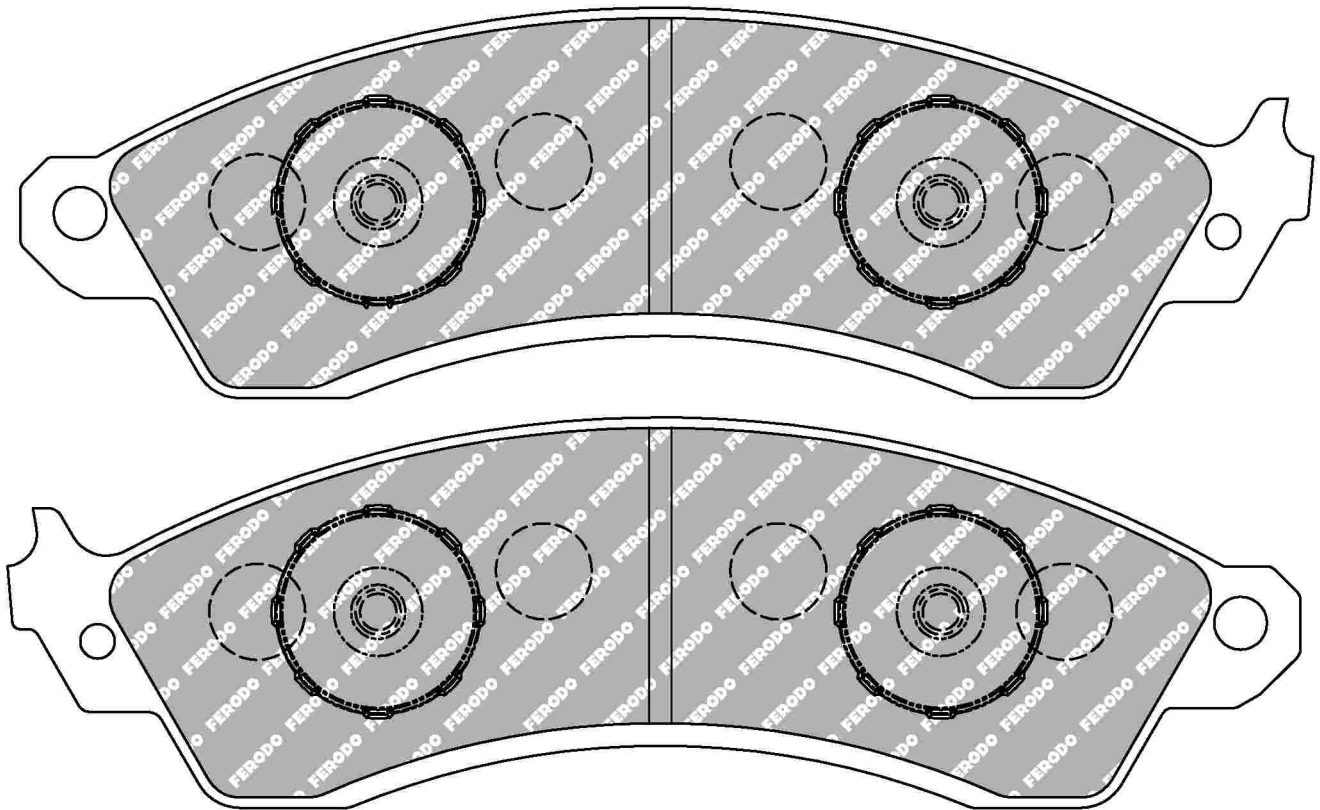

Set = 1 Left / 1 Right

MATERIAL AVAILABILITY

H	C	R	W	WB	Z	ZB
⚠		✉				

CROSS REFERENCE

BREMBO	07.8300.25
FMSI	D412
HAWK	HB111 0,61
PFC	0412
PFC	0412.XX

✓ Available ⚠ Exhausting
 ✗ Out of Range ✉ Make to order
 ⓘ In Introduction

FERODO
RACING
 Updated on 17th Aug 2018

3099

FCP1280

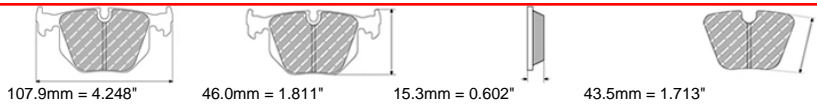

MITSUBISHI Rear

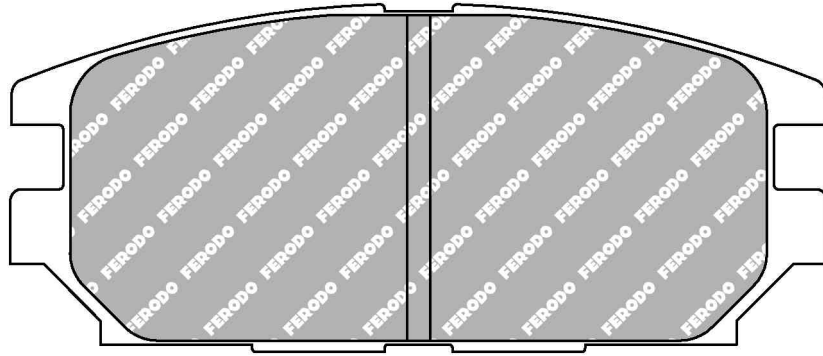

MATERIAL AVAILABILITY						
H	C	R	W	WB	Z	ZB
✓		✓	✉			

CROSS REFERENCE	
ALCON	PNF0084X232.4
MINTEX	MDB1693
PAGID	2445

FCP1281

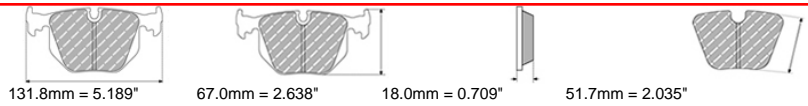

FMSI No: D810

AUDI Rear, LAMBORGHINI Rear, NISSAN Rear

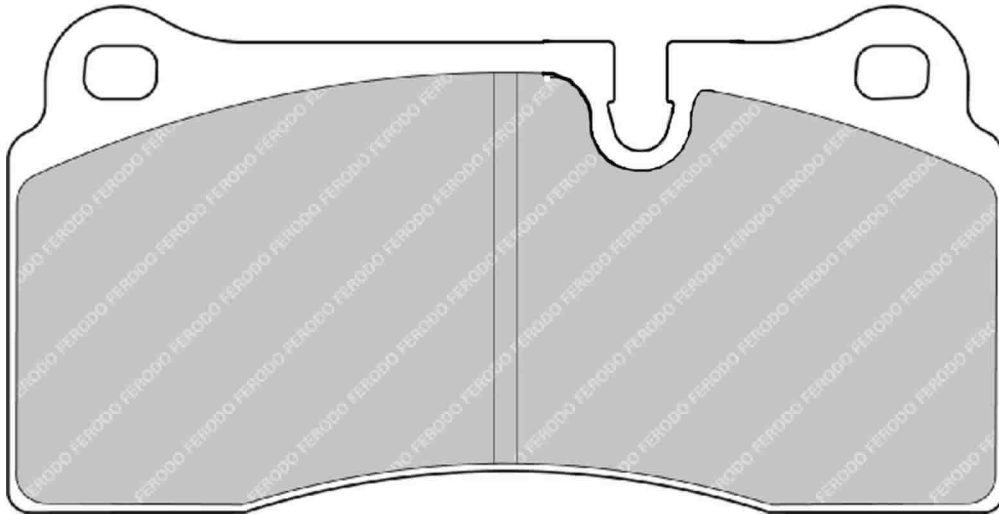

ALSO AVAILABLE		
SHAPE	TH. MM	NOTES
FRP3028	16	

MATERIAL AVAILABILITY						
H	C	R	W	WB	Z	ZB
✓		✓	✓			

CROSS REFERENCE	
ALCON	PNF0084X233.4
BREMBO	07.4865.1
BREMBO	07.4865.80
BREMBO	07.8301.61
BREMBO	07.8645.16
BREMBO	07.B314.30
CL BRAKES	5008W52T18
FMSI	D810
FMSI	D968
HAWK	HB193 0,67
MINTEX	MTX1976
PAGID	1287
PFC	7780.XX.18

FCP1283

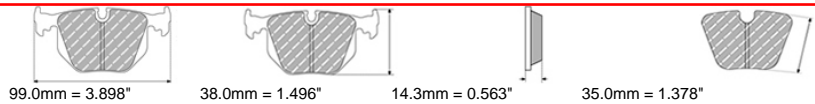

mitsubishi Rear

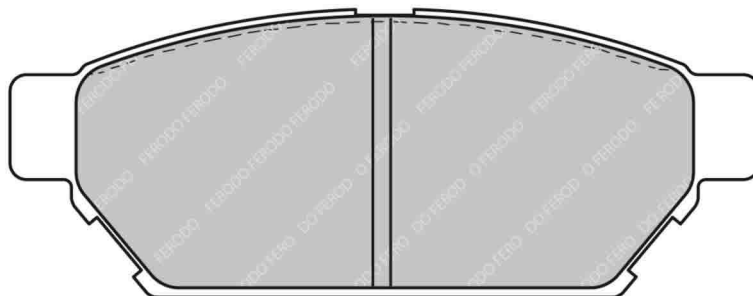

MATERIAL AVAILABILITY						
H	C	R	W	WB	Z	ZB
		✓				

CROSS REFERENCE	
ALCON	PNF0084X236.4
PAGID	1897

- ✓ Available
- ✗ Out of Range
- ⚠ Exhausting
- 📦 Make to order
- 👉 In Introduction

FCP1285

WVA No: 21273 19,50

FMSI No: D618

VOLVO Front



156.5mm = 6.161"



58.0mm = 2.283"



18.8mm = 0.740"

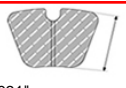

51.6mm = 2.031"

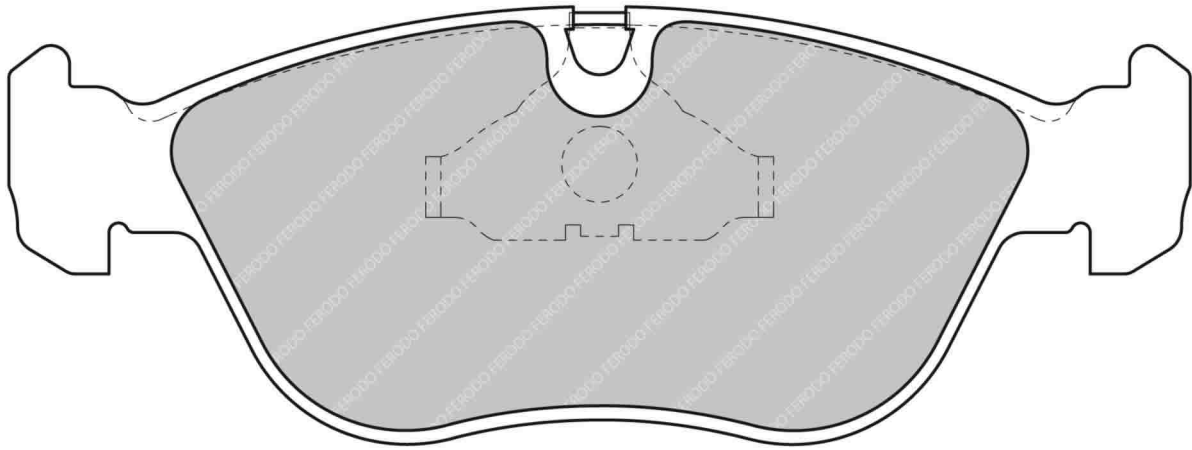

MATERIAL AVAILABILITY

H	C	R	W	WB	Z	ZB
✓		✓				

CROSS REFERENCE

FMSI	D618
HAWK	HB492 0,732
MINTEX	MDB1614
MINTEX	MDB1984
WVA	21273 19,50

FCP1288

WVA No: 21866 15,30



141.8mm = 5.583"
141.8mm = 5.583"



50.0mm = 1.969"
51.0mm = 2.008"



15.3mm = 0.602"
15.3mm = 0.602"

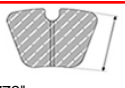

45.0mm = 1.772"
45.0mm = 1.772"

SEAT Front, VOLKSWAGEN Front

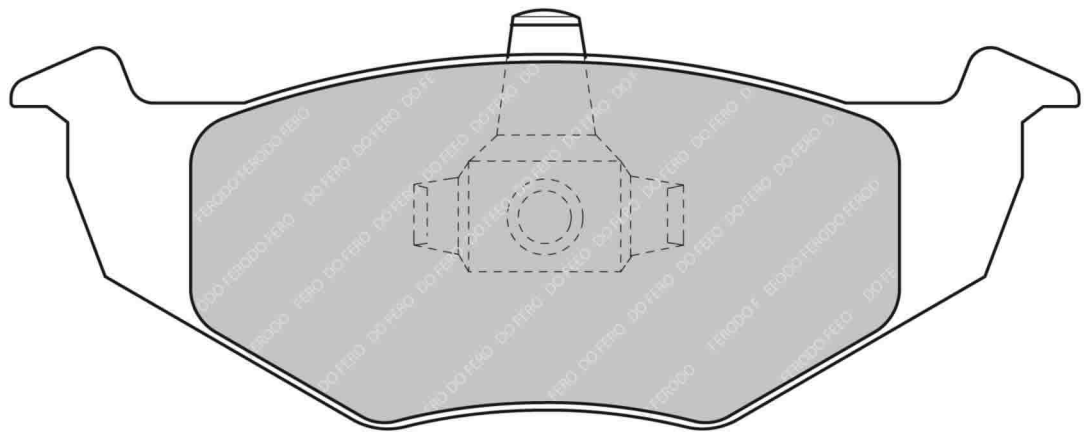
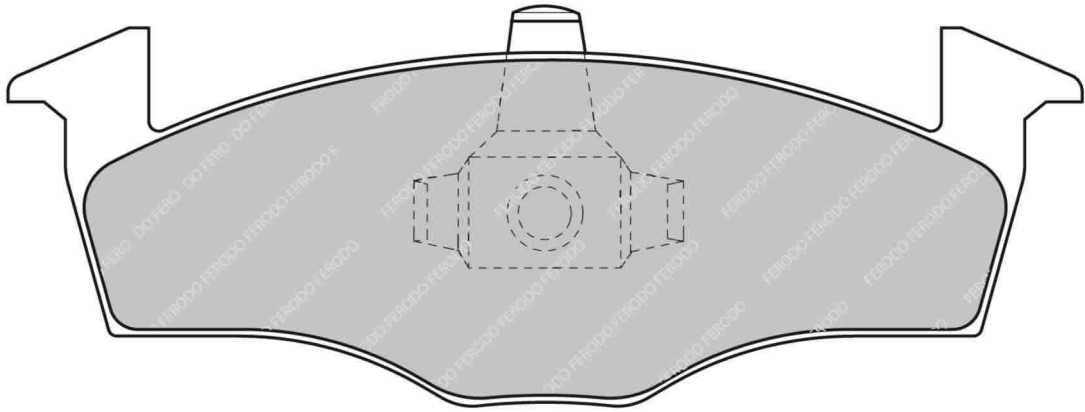

ALSO AVAILABLE

SHAPE	TH. MM	NOTES
FCP1054	19.3	
FCP1101	17.3	

CROSS REFERENCE

BREMBO	07.8301.62
MINTEX	MDB1872
WVA	21866 15,30

MATERIAL AVAILABILITY

H	C	R	W	WB	Z	ZB
⚠						

✓ Available
✗ Out of Range
🔧 In Introduction
⚠ Exhausting
📦 Make to order

FERODO
RACING
 Updated on 17th Aug 2018

3103

FCP1289

WVA No: 21945 19,90

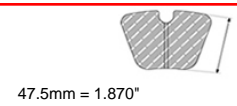
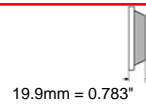
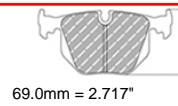
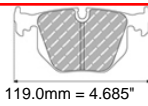

AUDI Front, SEAT Front, VOLKSWAGEN Front



ALSO AVAILABLE

SHAPE	TH. MM	NOTES
FCP1312	16	

CROSS REFERENCE

MINTEX	MDB1919
WVA	21945 19,90

MATERIAL AVAILABILITY

H	C	R	W	WB	Z	ZB
X						

FCP1293

WVA No: 23063 18,40



160.1mm = 6.303"
177.7mm = 6.996"



63.1mm = 2.484"
62.5mm = 2.461"



17.5mm = 0.689"
18.8mm = 0.740"

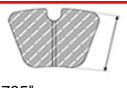

45.6mm = 1.795"
45.6mm = 1.795"

CHEVROLET Front, OPEL Front, VAUXHALL Front

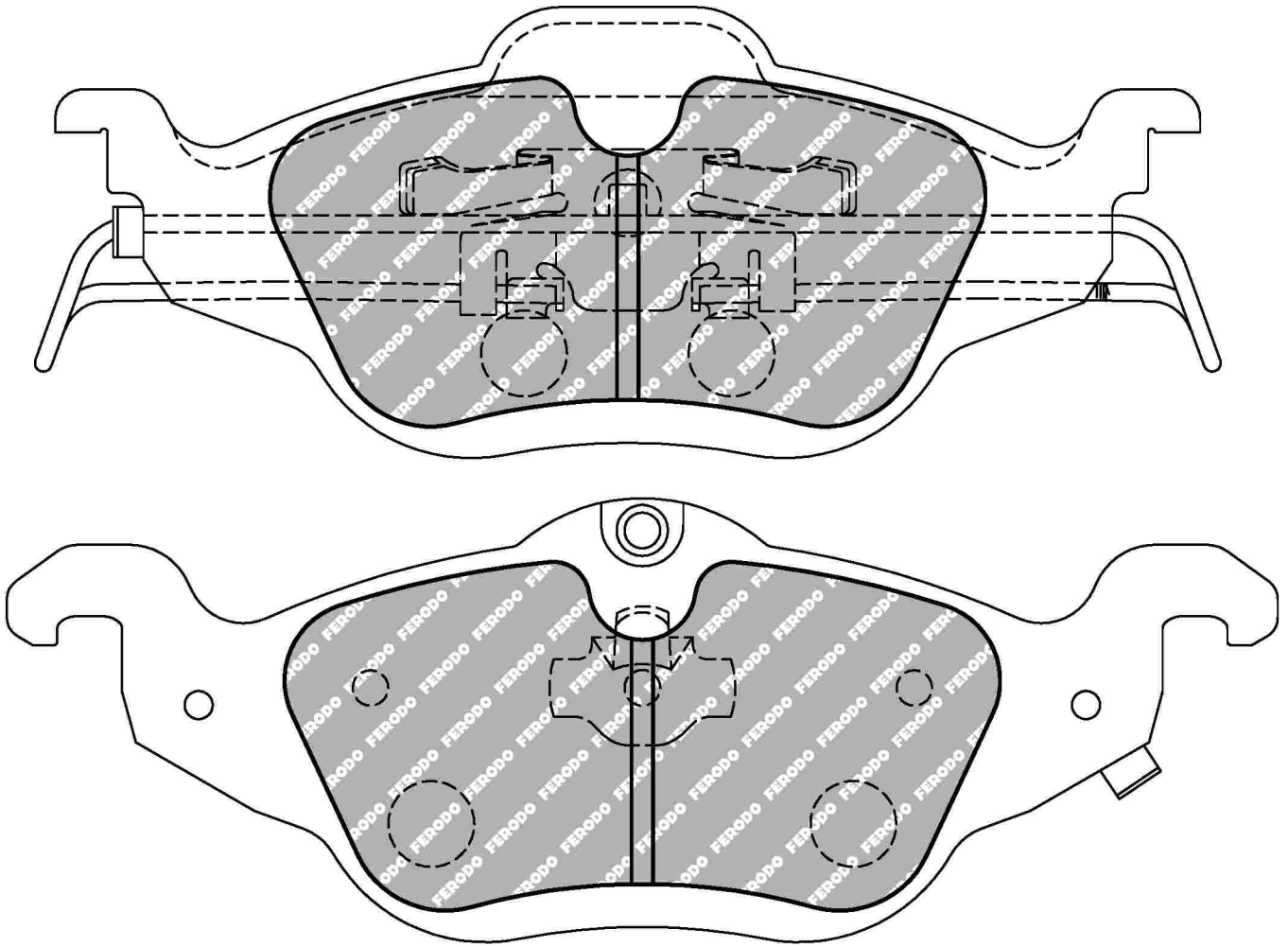

MATERIAL AVAILABILITY						
H	C	R	W	WB	Z	ZB
✓						

CROSS REFERENCE	
BREMBO	07.8301.64
MINTEX	MDB1908
WVA	23063 18,40

- ✓ Available
- ✗ Out of Range
- ⓘ In Introduction
- ⚠ Exhausting
- 📦 Make to order

FCP1294

WVA No: 23052 16,20



104.9mm = 4.130"



42.5mm = 1.673"



16.3mm = 0.642"

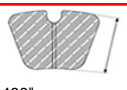

37.8mm = 1.488"

OPEL Rear, VAUXHALL Rear

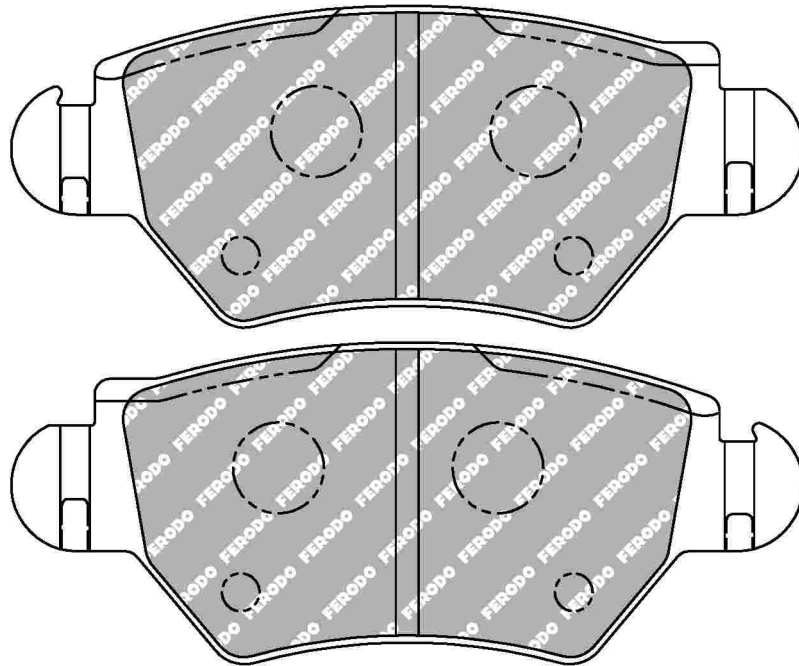

MATERIAL AVAILABILITY						
H	C	R	W	WB	Z	ZB

CROSS REFERENCE	
MINTEX	MDB2130
WVA	23052 16,20

FCP1295

WVA No: 23057 20,00



155.5mm = 6.122"
156.5mm = 6.161"



71.4mm = 2.811"
78.5mm = 3.091"



19.4mm = 0.764"
19.4mm = 0.764"

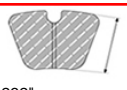

56.7mm = 2.232"
56.7mm = 2.232"

CHEVROLET Front, OPEL Front, VAUXHALL Front

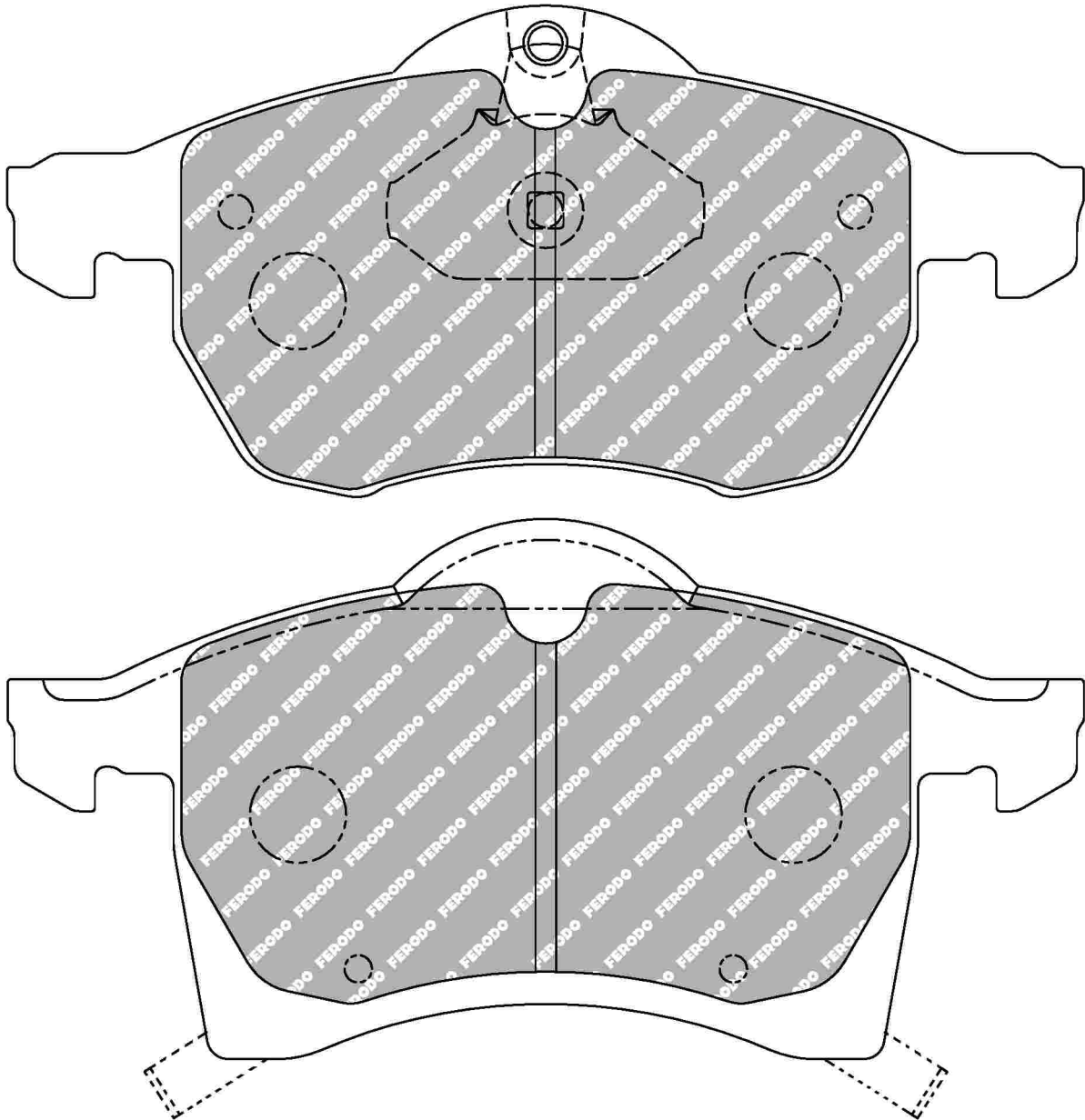

MATERIAL AVAILABILITY						
H	C	R	W	WB	Z	ZB
✓						

CROSS REFERENCE	
BREMBO	07.8301.65
MINTEX	MDB1907
WVA	23057 20,00

- ✓ Available
- ✗ Out of Range
- ⚠ Exhausting
- 📦 Make to order
- 📅 In Introduction

FCP1298



119.8mm = 4.717"



73.7mm = 2.902"



18.0mm = 0.709"

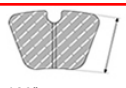

55.6mm = 2.189"

FMSI No: D639

BMW Front, FERRARI Front / Rear, FIAT Front, MASERATI Front, NISSAN Front

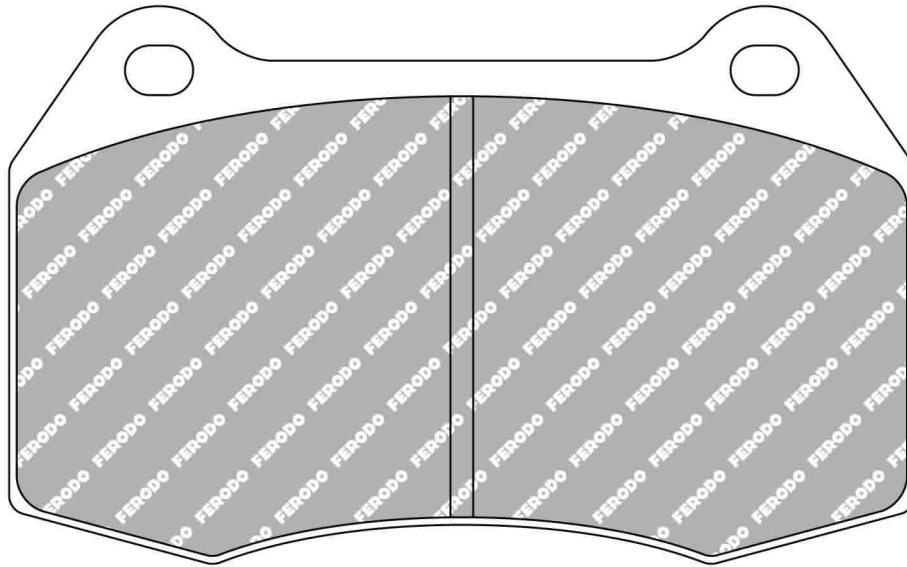

Replacing FCP998

MATERIAL AVAILABILITY

H	C	R	W	WB	Z	ZB
✓		✓	✉		✉	

CROSS REFERENCE

BREMBO	07.9184.45
CL BRAKES	4061
FMSI	D639
HAWK	HB181 0,66
MINTEX	MDB1752
PAGID	1427
PFC	0639

FCP1300

WVA No: 21925 17,80

FMSI No: D781



151.4mm = 5.961"



57.5mm = 2.264"



16.9mm = 0.665"

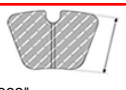

52.4mm = 2.063"

BMW Front

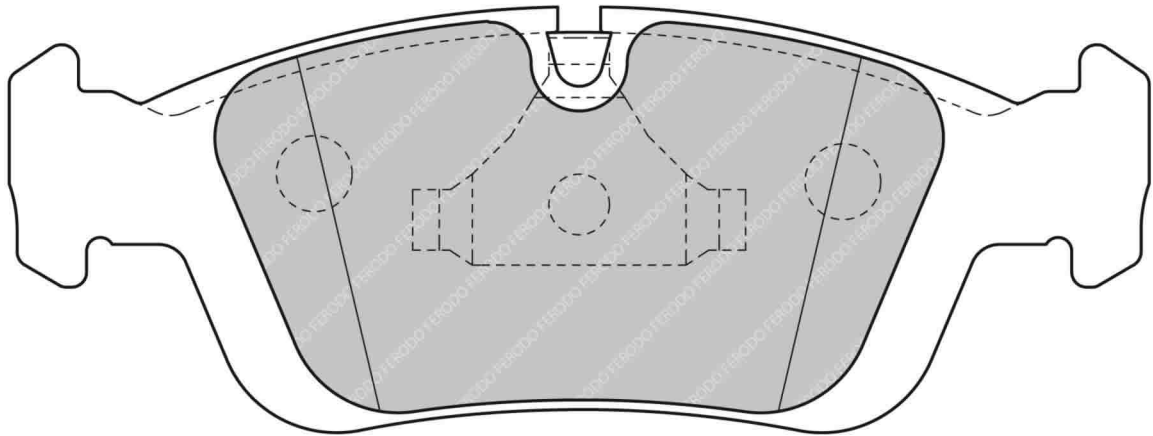

MATERIAL AVAILABILITY						
H	C	R	W	WB	Z	ZB
✓						

CROSS REFERENCE	
CL BRAKES	4104
FMSI	D781
HAWK	HB546 0,654
MINTEX	MDB1901
PAGID	2180
WVA	21925 17,80

FCP1301

WVA No: 21934 17,30

FMSI No: D692



123.2mm = 4.850"



43.7mm = 1.720"



16.6mm = 0.654"

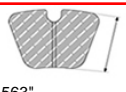

39.7mm = 1.563"

BMW Rear

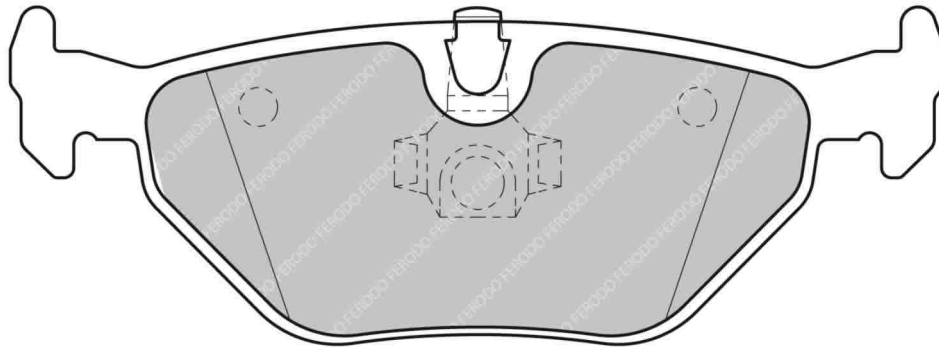

MATERIAL AVAILABILITY						
H	C	R	W	WB	Z	ZB
✓		✉				

CROSS REFERENCE	
FMSI	D692
MINTEX	MDB1888
MINTEX	MDB2763
WVA	21934 17,30

✓ Available
 ✗ Out of Range
 ✉ In Introduction
 ⚠ Exhausting
 📧 Make to order

FCP1307

WVA No: 21937 16,20

FMSI No: D737

PORSCHE Front



114.0mm = 4.488"



78.3mm = 3.083"



15.4mm = 0.606"



54.0mm = 2.126"

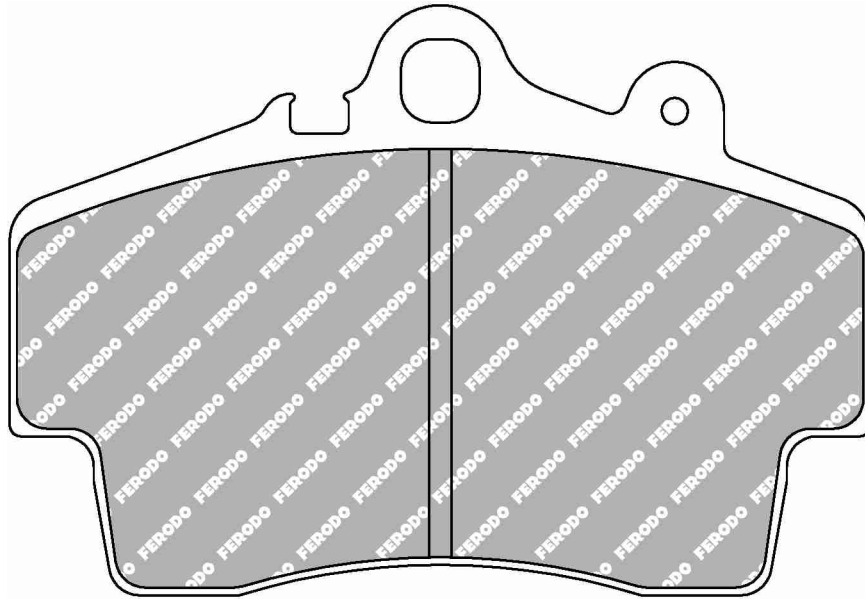

MATERIAL AVAILABILITY						
H	C	R	W	WB	Z	ZB
✓		✓	✓			

CROSS REFERENCE	
FMSI	D737
HAWK	HB289 0,61
MINTEX	MDB1873
PAGID	2407
PAGID	T5124
PFC	0738
WVA	21937 16,20

FCP1308

WVA No: 21972 15,20

FMSI No: D738

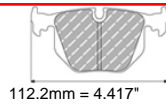

112.2mm = 4.417"

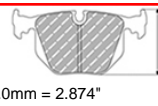

73.0mm = 2.874"



15.5mm = 0.610"



48.0mm = 1.890"

AUDI Rear, PORSCHE Rear, VOLKSWAGEN Rear

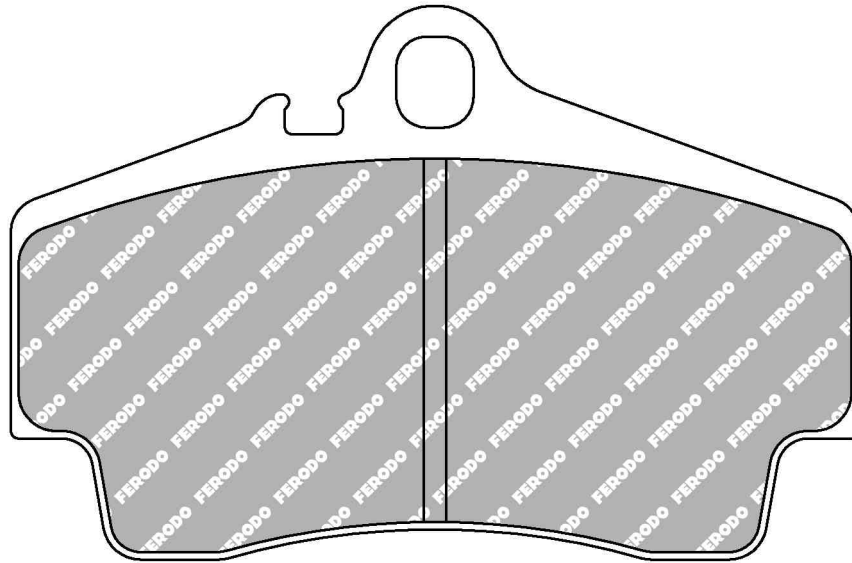

MATERIAL AVAILABILITY						
H	C	R	W	WB	Z	ZB
✓		✓	✓			

CROSS REFERENCE	
CL BRAKES	4049
FMSI	D738
FMSI	D978
HAWK	HB290 0,583
MINTEX	MDB1874
PAGID	2406
PAGID	T1698
PAGID	T5125
PFC	0738
WVA	21972 15,20
WVA	23694

✓ Available ⚠ Exhausting
 ✗ Out of Range 📦 Make to order
 📌 In Introduction

FCP1312

WVA No: 21945 16,00

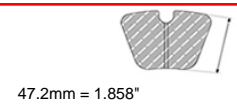
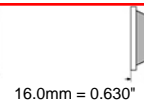
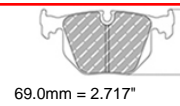
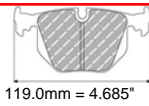

SEAT Front, VOLKSWAGEN Front / Rear

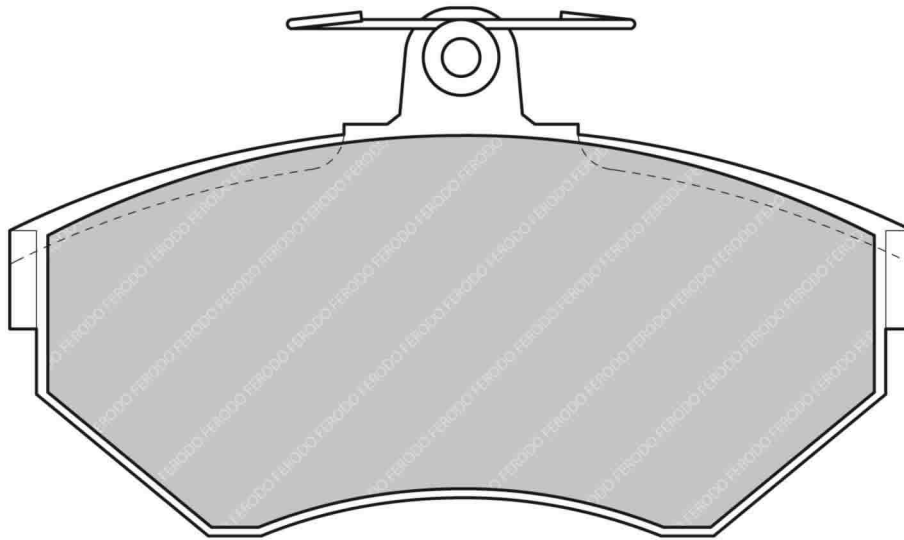

ALSO AVAILABLE		
SHAPE	TH. MM	NOTES
FCP1289	19.9	

CROSS REFERENCE	
MINTEX	MDB1868
WVA	21945 16,00

MATERIAL AVAILABILITY						
H	C	R	W	WB	Z	ZB
✓					✉	

FCP1318

WVA No: 23154 19,00

FMSI No: D816

FORD Front, FORD USA Front



177.9mm = 7.004"



60.8mm = 2.394"



19.0mm = 0.748"

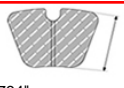

44.8mm = 1.764"

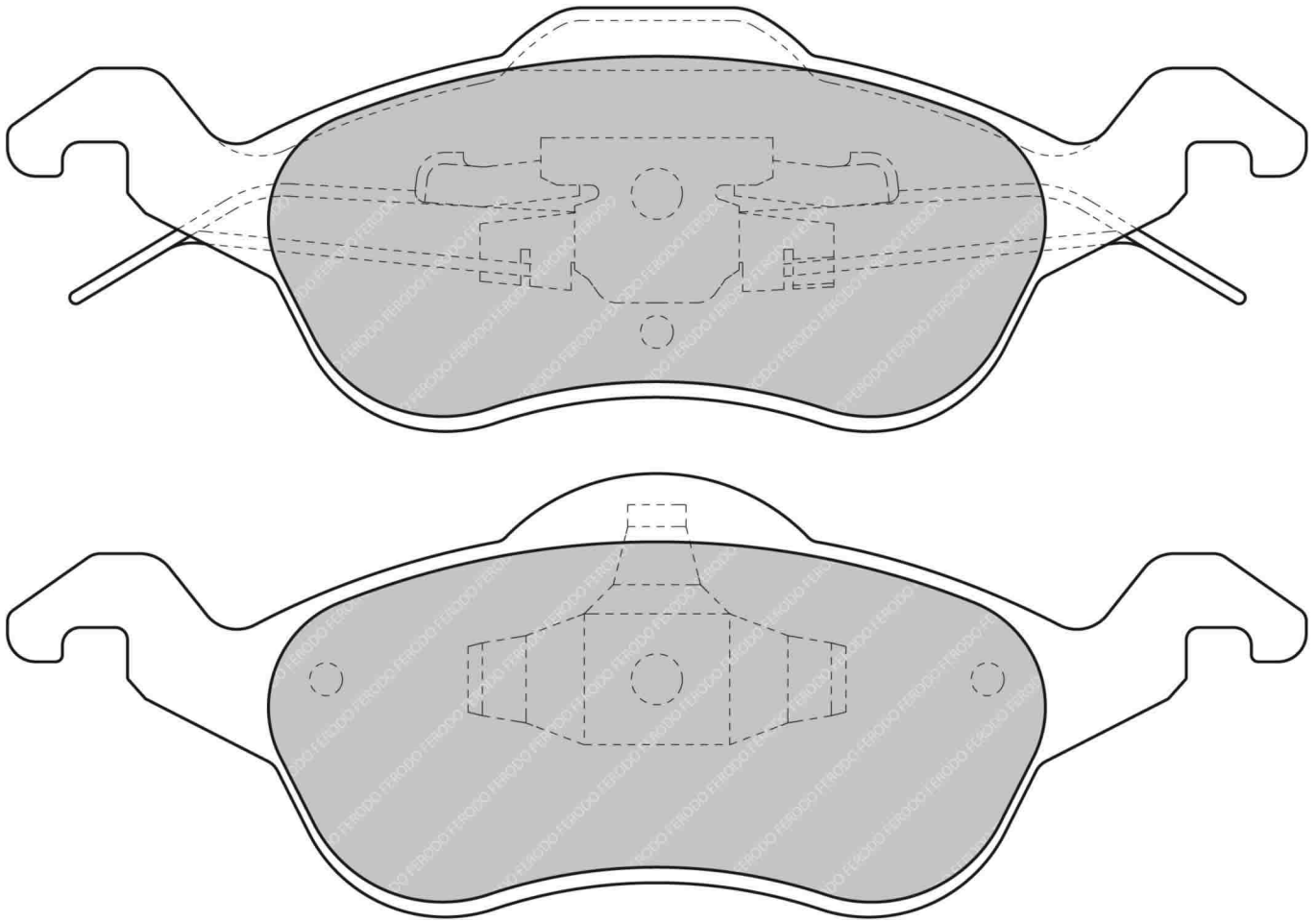

MATERIAL AVAILABILITY

H	C	R	W	WB	Z	ZB
✓		✉				

CROSS REFERENCE

BREMBO	07.8301.72
FMSI	D816
HAWK	HB346 0,713
MINTEX	MDB1958
PFC	0816.XX
WVA	23154 19,00

✓ Available ⚠ Exhausting
 ✗ Out of Range ✉ Make to order
 ⓘ In Introduction

FCP1319

WVA No: 23353 14,70

FMSI No: D886

FORD Rear



87.7mm = 3.453"



42.6mm = 1.677"



14.9mm = 0.587"

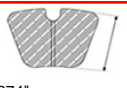

34.9mm = 1.374"

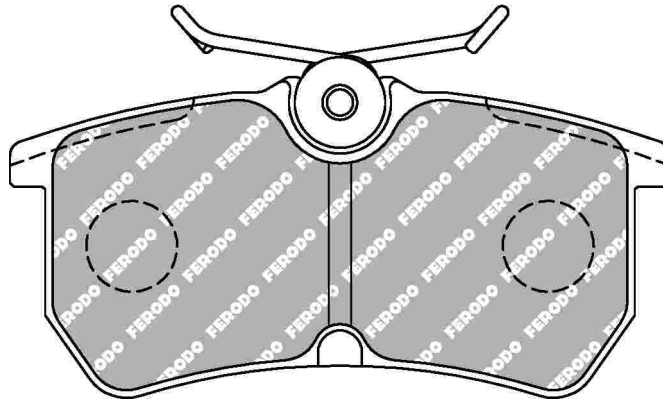

MATERIAL AVAILABILITY						
H	C	R	W	WB	Z	ZB
✓						

CROSS REFERENCE	
FMSI	D886
HAWK	HB430 0,547
MINTEX	MDB1959
WVA	23353 14,70

FCP1323

WVA No: 21938 20,40

FMSI No: D840

AUDI Front, VOLKSWAGEN Front



156.5mm = 6.161"



74.0mm = 2.913"



21.3mm = 0.839"

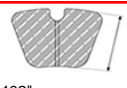

61.0mm = 2.402"

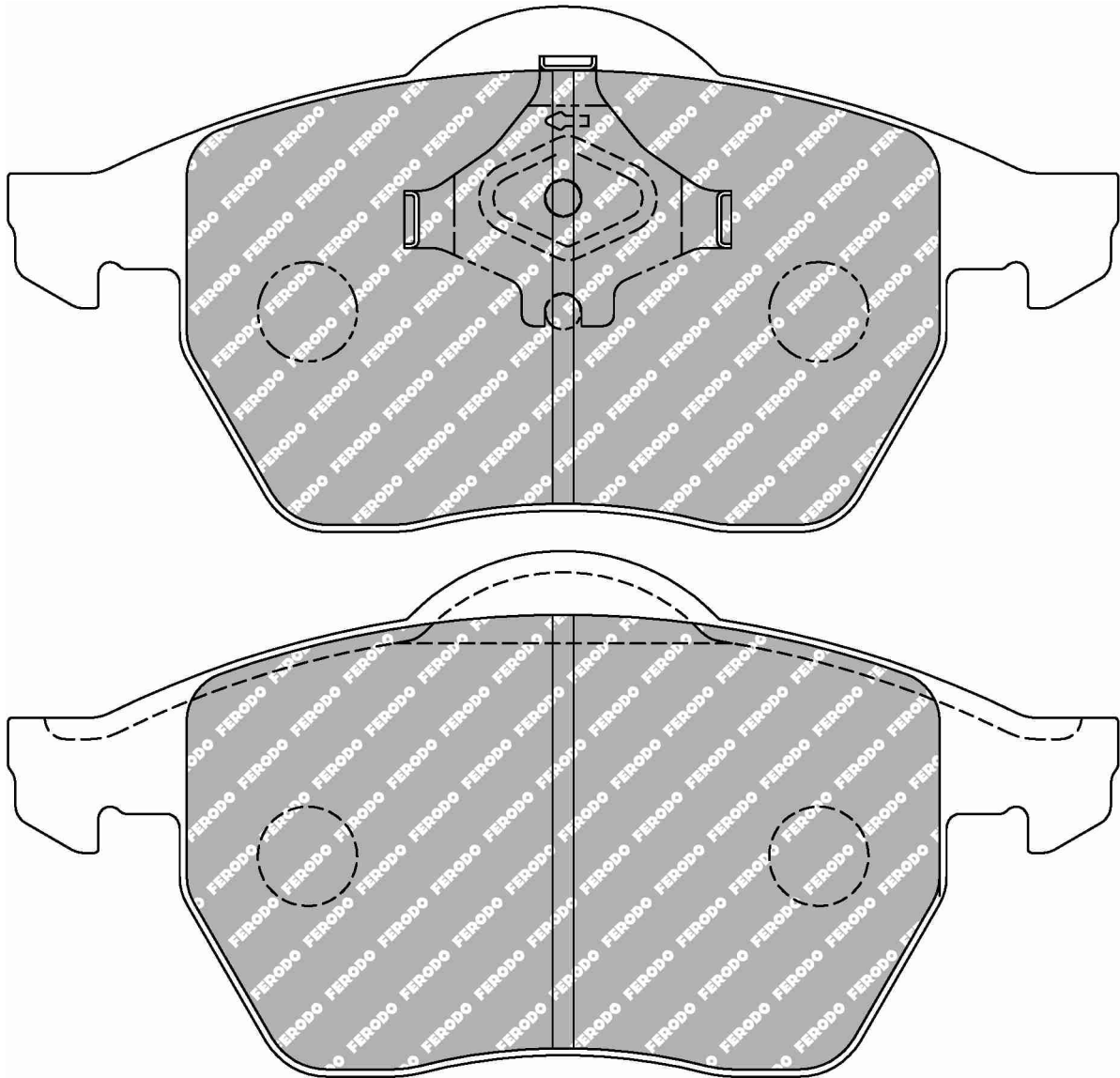

MATERIAL AVAILABILITY						
H	C	R	W	WB	Z	ZB
✓						

CROSS REFERENCE	
CL BRAKES	4023
FMSI	D840
HAWK	HB354 .756A
MINTEX	MDB1826
WVA	21938 20,40

- ✓ Available
- ✗ Out of Range
- ⓘ In Introduction
- ⚠ Exhausting
- 📦 Make to order

FCP1324

WVA No: 23601 16,70



95.8mm = 3.772"



44.0mm = 1.732"



13.9mm = 0.547"

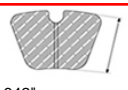

41.7mm = 1.642"

ABARTH Rear, FIAT Rear, LANCIA Rear

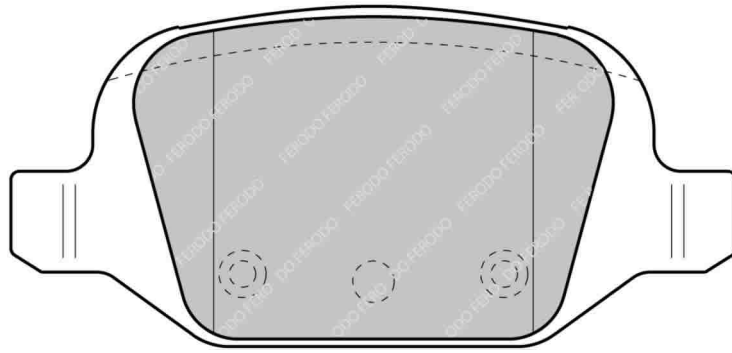

PIN 5mm on the backplate

MATERIAL AVAILABILITY						
H	C	R	W	WB	Z	ZB
✓						

CROSS REFERENCE	
MINTEX	MDB2042
WVA	23601 16,70

FCP1327

WVA No: 23558 17,80

FMSI No: D721



138.0mm = 5.433"



59.8mm = 2.354"



17.0mm = 0.669"

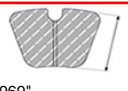

50.0mm = 1.969"

SUBARU Front

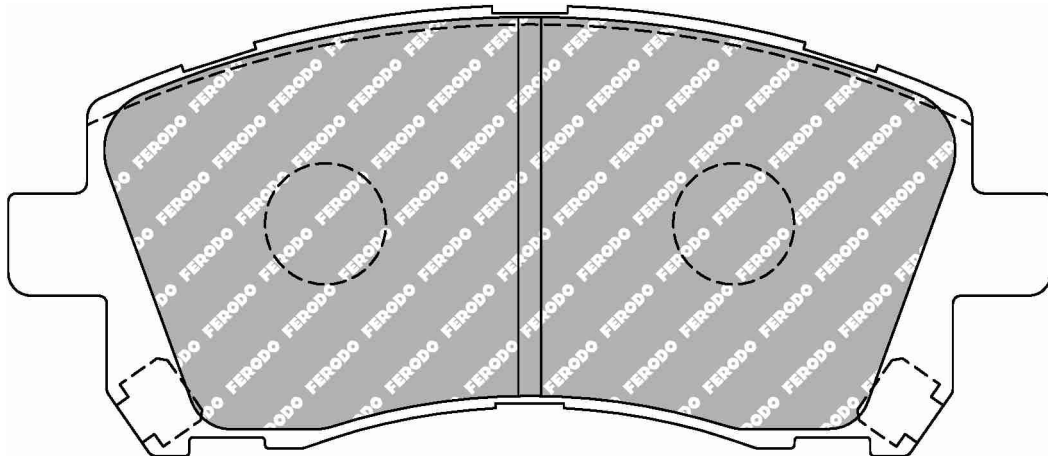

MATERIAL AVAILABILITY						
H	C	R	W	WB	Z	ZB
✓		✉				

CROSS REFERENCE	
BREMBO	07.8300.42
CL BRAKES	4029
FMSI	D721
HAWK	HB352 0,665
MINTEX	MDB1794
PAGID	ERS651
WVA	23558 17,80

FCP1333

WVA No: 23572 14,40

FMSI No: D770

SUBARU Rear



108.4mm = 4.268"



41.9mm = 1.650"



14.0mm = 0.551"

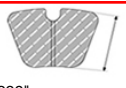

34.0mm = 1.339"

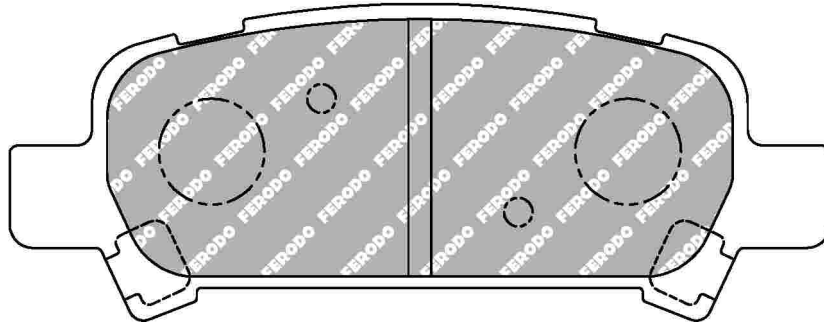

MATERIAL AVAILABILITY						
H	C	R	W	WB	Z	ZB
✓		✓				

CROSS REFERENCE	
CL BRAKES	4059
FMSI	D770
HAWK	HB434 0,543
MINTEX	MDB1999
WVA	23572 14,40

✓ Available ⚠ Exhausting
 ✗ Out of Range 📦 Make to order
 📌 In Introduction

FCP1334

WVA No: 23092 16,00

FMSI No: D1001

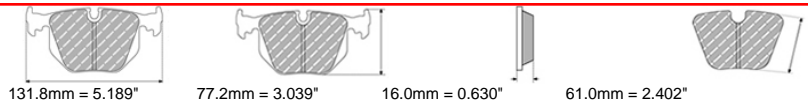

ALFA ROMEO Front, AUDI Front, CADILLAC Front, CHEVROLET Front, CITROEN Front, FORD Front, LANCIA Front, LAND ROVER Front, MASERATI Front, MITSUBISHI Front, OPEL Front, RENAULT Front, VOLKSWAGEN Front, VOLVO Front

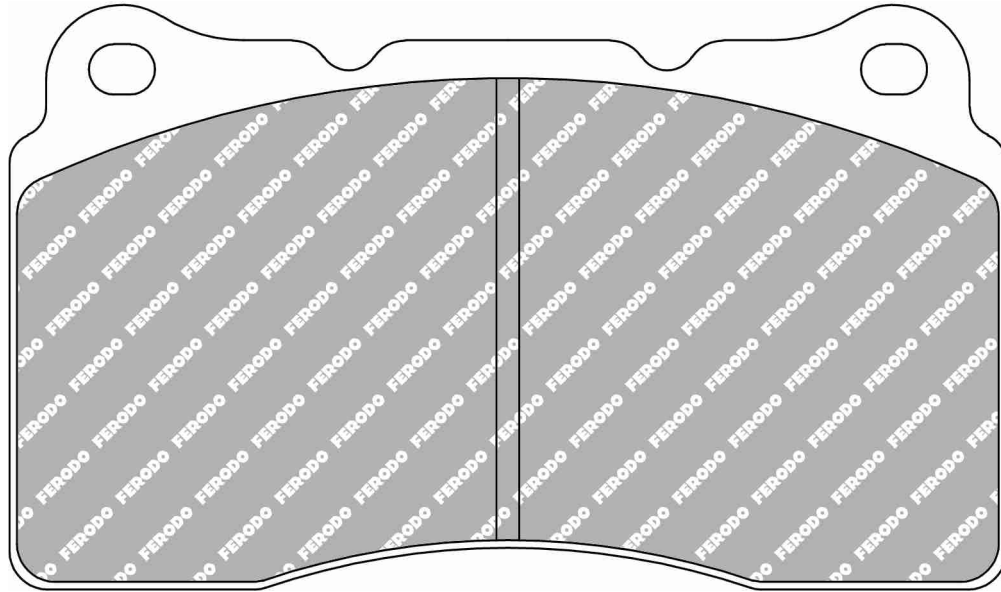

ALSO AVAILABLE

SHAPE	TH. MM	NOTES
FRP3067	14.7	

MATERIAL AVAILABILITY

H	C	R	W	WB	Z	ZB
✓		✓	✓		✓	

CROSS REFERENCE

ALCON	PNF0084X268.4
ALCON	PNF0084X359.4
BREMBO	07.7275.68
BREMBO	07.8301.74
CL BRAKES	4066
FMSI	D1001
FMSI	D1016
FMSI	D1050
HAWK	HB453 0,585
MINTEX	MDB1859
MINTEX	MDB1950
PAGID	2487
PFC	7781
WVA	23092 16,00

FCP1348

WVA No: 21381 15,00

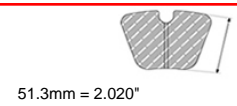
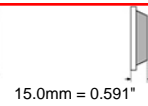
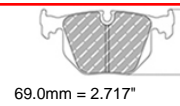
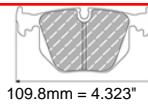

CHEVROLET Front / Rear, CITROEN Front, FERRARI Front / Rear, FORD Front, MASERATI Rear, PEUGEOT Front, RENAULT Front / Rear, SEAT Front, TESLA Rear, VOLVO Rear

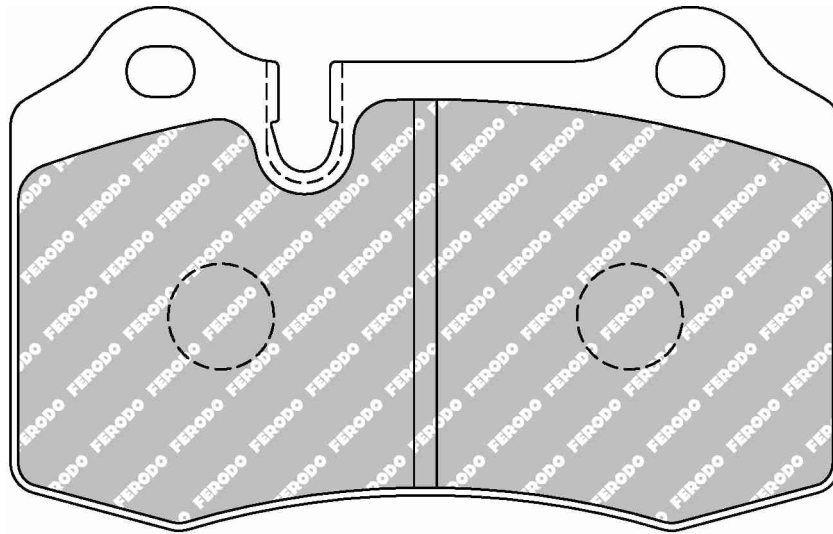

ALSO AVAILABLE		
SHAPE	TH. MM	NOTES
FCP721	17.3	
FRP3109	12.5	

MATERIAL AVAILABILITY						
H	C	R	W	WB	Z	ZB
✓		✓	✓		✓	

CROSS REFERENCE	
BREMBO	07.5146.30
BREMBO	07.5146.31
BREMBO	07.6953.9
BREMBO	07.8720.XX
MINTEX	MDB2221
PAGID	1408
PFC	0592.XX.15
WVA	21381 15,00

FCP1349

WVA No: 23517 16,60

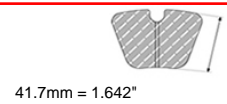
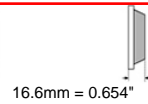
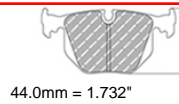
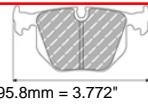

ALFA ROMEO Rear, FIAT Rear, LANCIA Rear

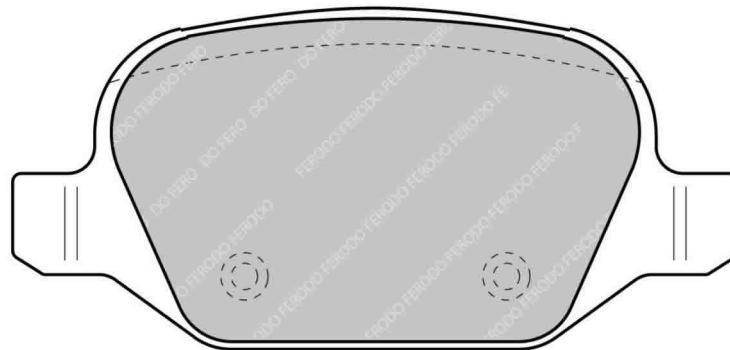

MATERIAL AVAILABILITY						
H	C	R	W	WB	Z	ZB
✓		✗				

CROSS REFERENCE	
MINTEX	MDB2051
WVA	23517 16,60

- ✓ Available
- ✗ Out of Range
- 📦 In Introduction
- ⚠ Exhausting
- 📄 Make to order

FCP1368

WVA No: 23348 16,50

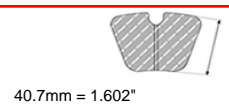
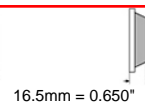
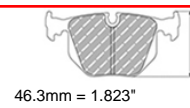
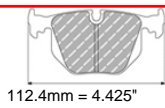

TOYOTA Front

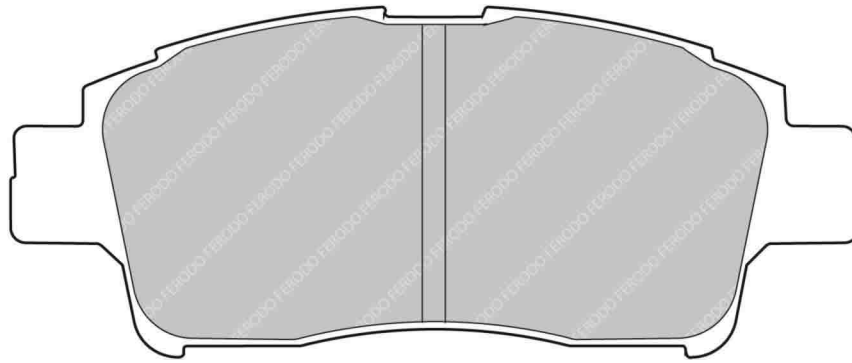

MATERIAL AVAILABILITY						
H	C	R	W	WB	Z	ZB
✓		✗				

CROSS REFERENCE	
BREMBO	07.8301.76
MINTEX	MDB2006
WVA	23348 16,50

FCP1370

WVA No: 23332 18,00

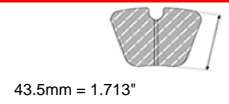
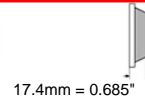
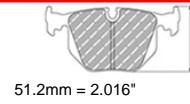
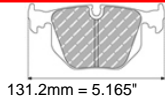

CITROEN Front, PEUGEOT Front

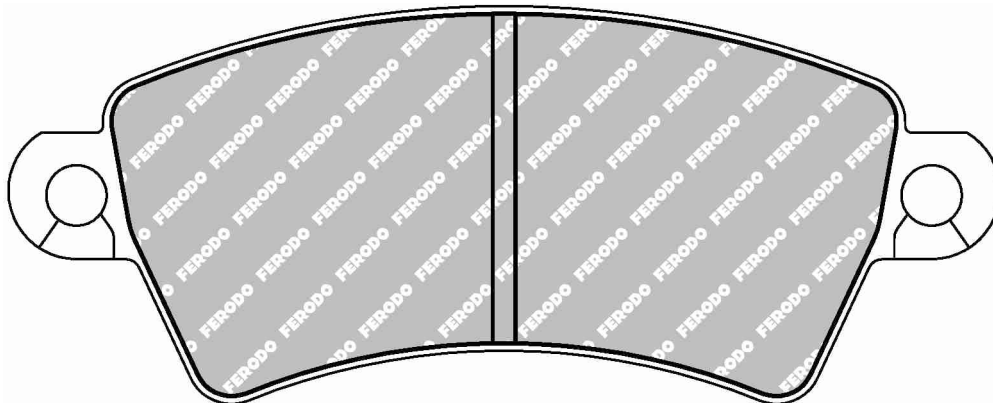

MATERIAL AVAILABILITY						
H	C	R	W	WB	Z	ZB
✓		✓				

CROSS REFERENCE	
MINTEX	MDB2012
WVA	23332 18,00

FCP1372

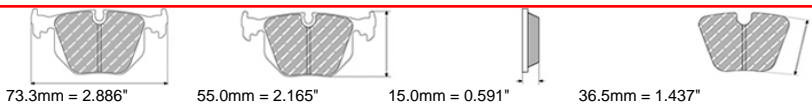

FMSI No: D461

SUBARU Rear

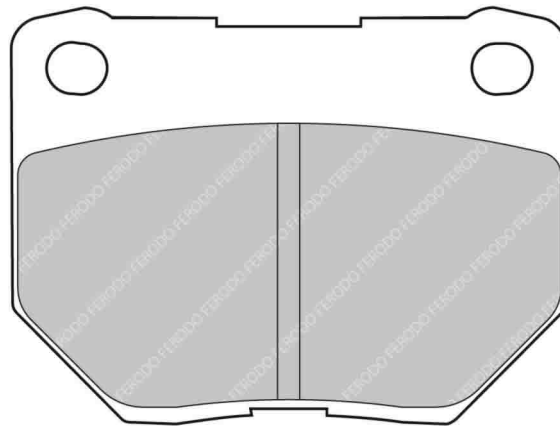

MATERIAL AVAILABILITY						
H	C	R	W	WB	Z	ZB
✓		✓				

CROSS REFERENCE	
ALCON	PNF0084X298.4
CL BRAKES	4069
FMSI	D461
HAWK	HB179 0,63
MINTEX	MDB2562
PFC	0461
PFC	0461.XX

✓ Available ⚠ Exhausting
 ✗ Out of Range 📦 Make to order
 📌 In Introduction

FCP1376

WVA No: 23552 17,80



150.3mm = 5.917"
151.5mm = 5.965"



52.6mm = 2.071"
52.6mm = 2.071"



17.0mm = 0.669"
17.0mm = 0.669"

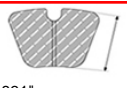

46.5mm = 1.831"
46.5mm = 1.831"

FIAT Front

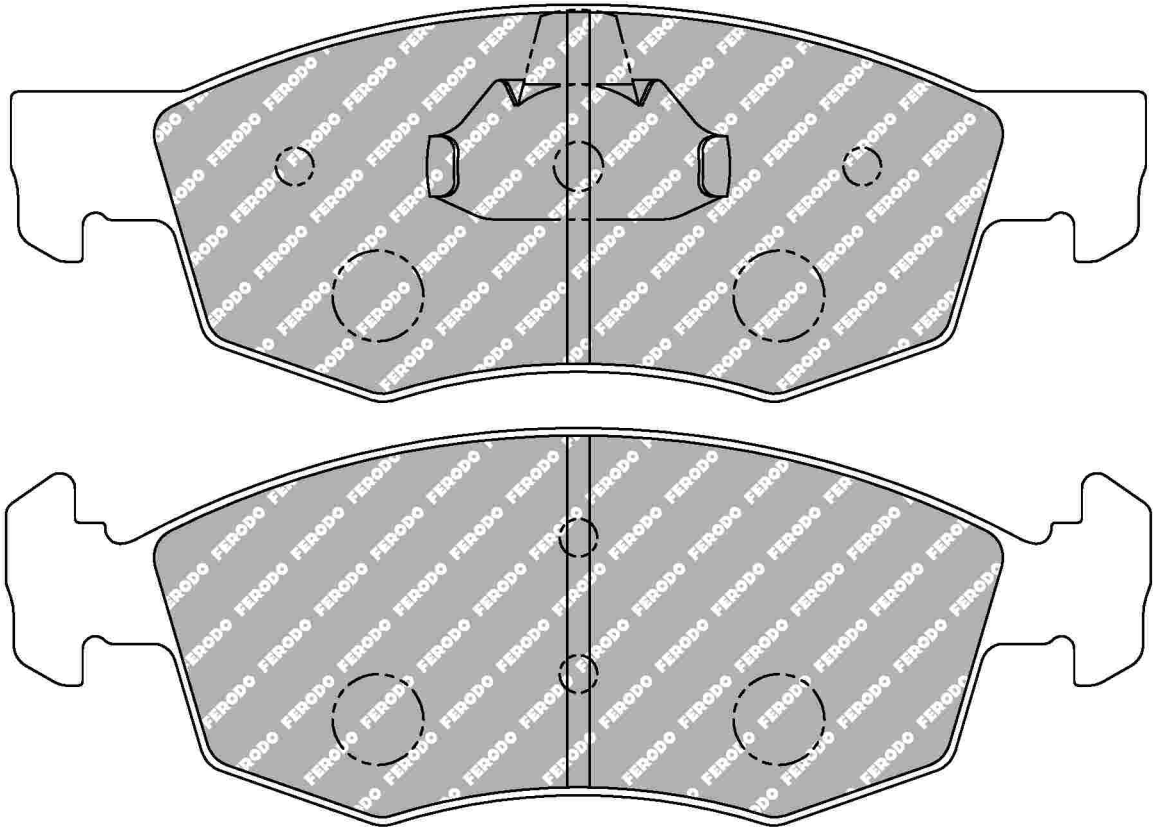

MATERIAL AVAILABILITY						
H	C	R	W	WB	Z	ZB
✓		✓				

CROSS REFERENCE	
BREMBO	07.8301.77
MINTEX	MDB2076
WVA	23552 17,80

FCP1378

WVA No: 23597 16,80



131.0mm = 5.157"



47.5mm = 1.870"



16.8mm = 0.661"



42.5mm = 1.673"

CITROEN Front / Rear, PEUGEOT Front

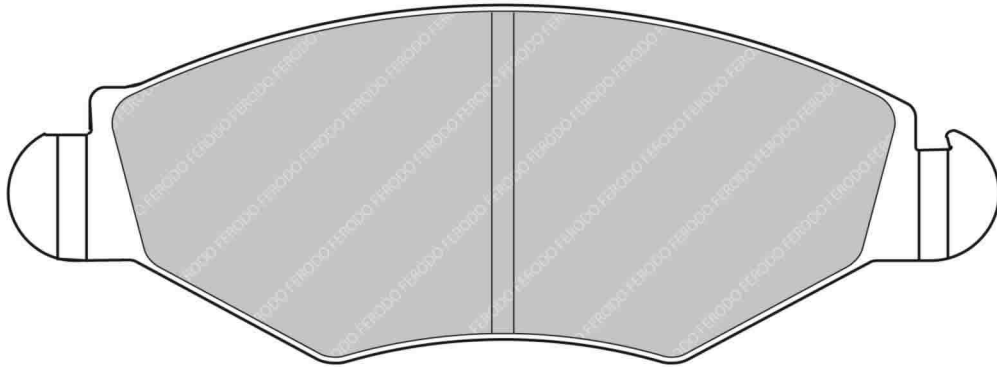
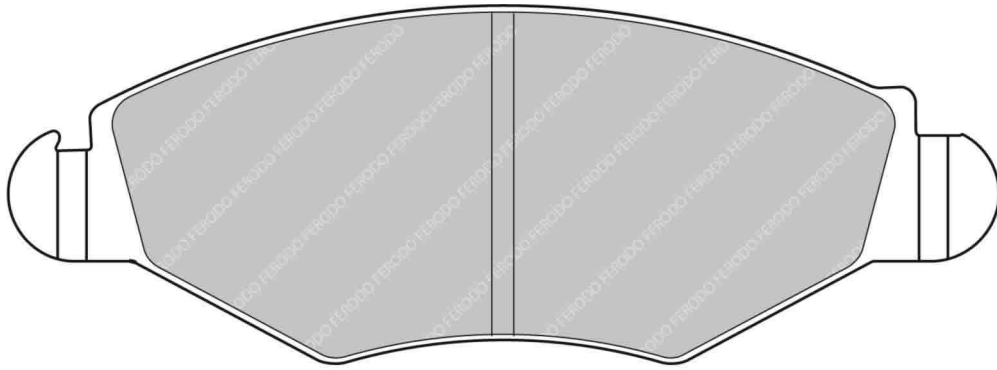

MATERIAL AVAILABILITY

H	C	R	W	WB	Z	ZB
✓		✓				

CROSS REFERENCE

ALCON	PNF0084X321.4
BREMBO	07.8301.78
MINTEX	MDB2131
WVA	23597 16,80

✓ Available
 ✗ Out of Range
 ⓘ In Introduction
 ⚠ Exhausting
 📦 Make to order

FERODO
RACING
 Updated on 17th Aug 2018

3123

FCP1382

WVA No: 23073 18,80

FMSI No: D794

VOLVO Front



155.4mm = 6.118"
156.5mm = 6.161"



69.0mm = 2.717"
69.0mm = 2.717"



17.9mm = 0.705"
17.9mm = 0.705"

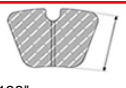

54.3mm = 2.138"
54.3mm = 2.138"

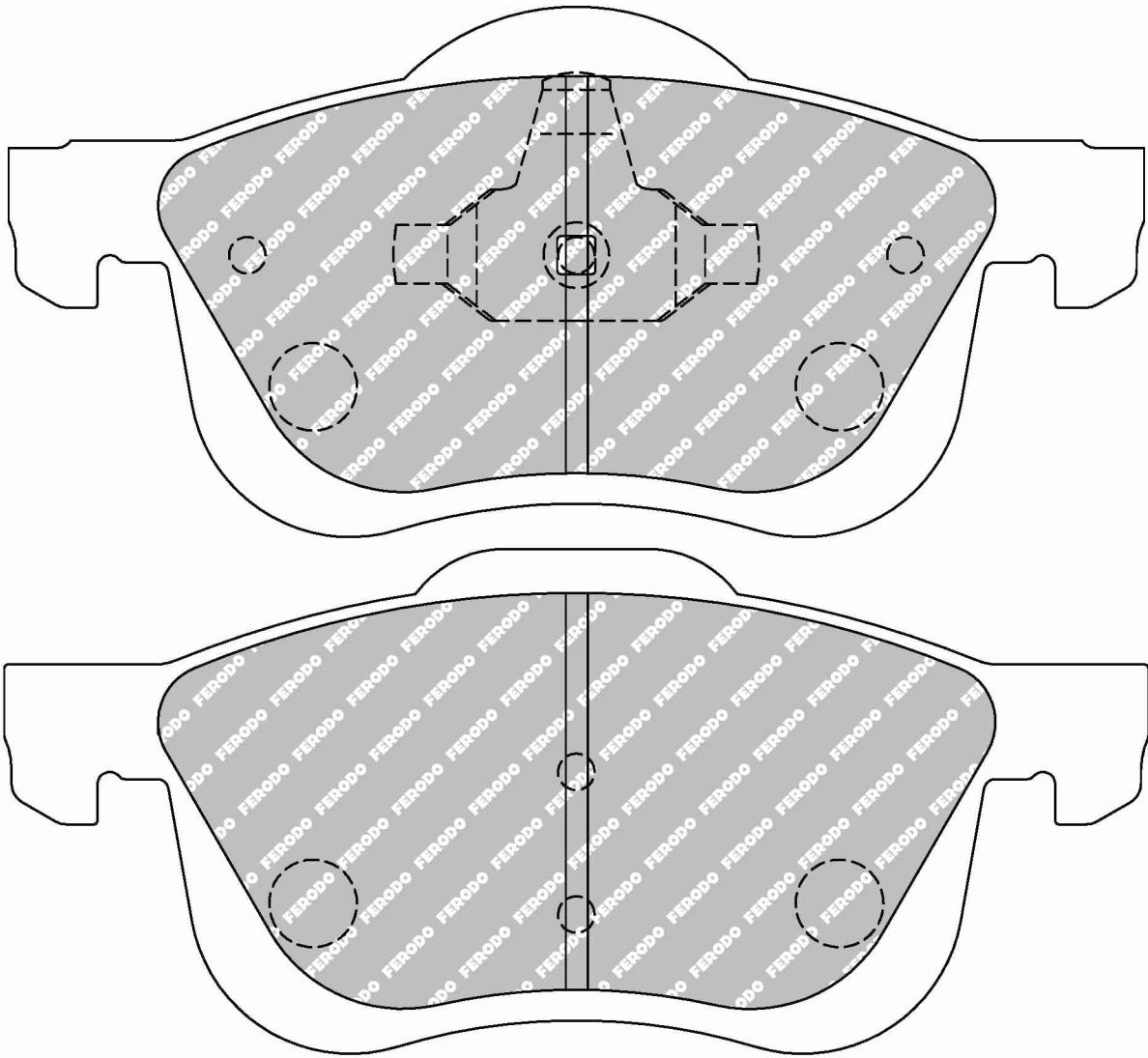

MATERIAL AVAILABILITY						
H	C	R	W	WB	Z	ZB

CROSS REFERENCE	
FMSI	D794
HAWK	HB491 0,693
MINTEX	MDB1944
WVA	23073 18,80

FCP1392

WVA No: 23510 16,50

FMSI No: D990

TOYOTA Front



116.6mm = 4.591"



51.0mm = 2.008"



16.5mm = 0.650"

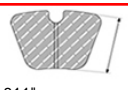

46.0mm = 1.811"

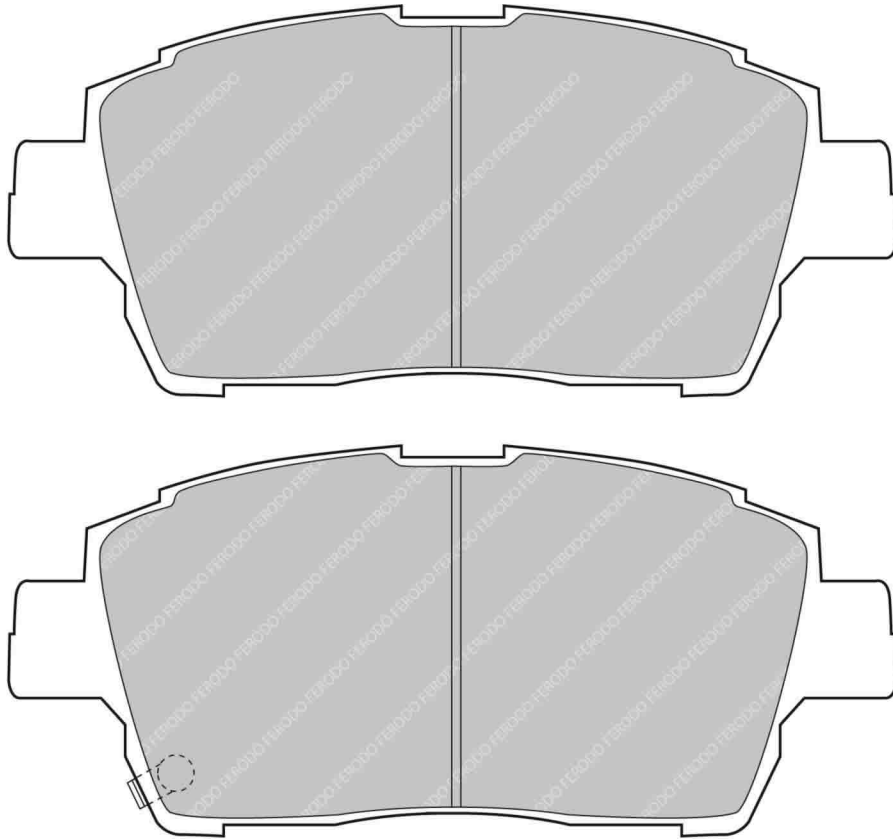

MATERIAL AVAILABILITY						
H	C	R	W	WB	Z	ZB
✓						

CROSS REFERENCE	
FMSI	D990
HAWK	HB493 0,65
MINTEX	MDB2029
PAGID	8029
WVA	23510 16,50

- ✓ Available
- ✗ Out of Range
- ⓘ In Introduction
- ⚠ Exhausting
- 📦 Make to order

FCP1394

WVA No: 23202 18,50



150.2mm = 5.913"
151.4mm = 5.961"



61.5mm = 2.421"
59.0mm = 2.323"



18.6mm = 0.732"
18.6mm = 0.732"

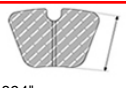

48.1mm = 1.894"
48.1mm = 1.894"

FORD Front, MAZDA Front

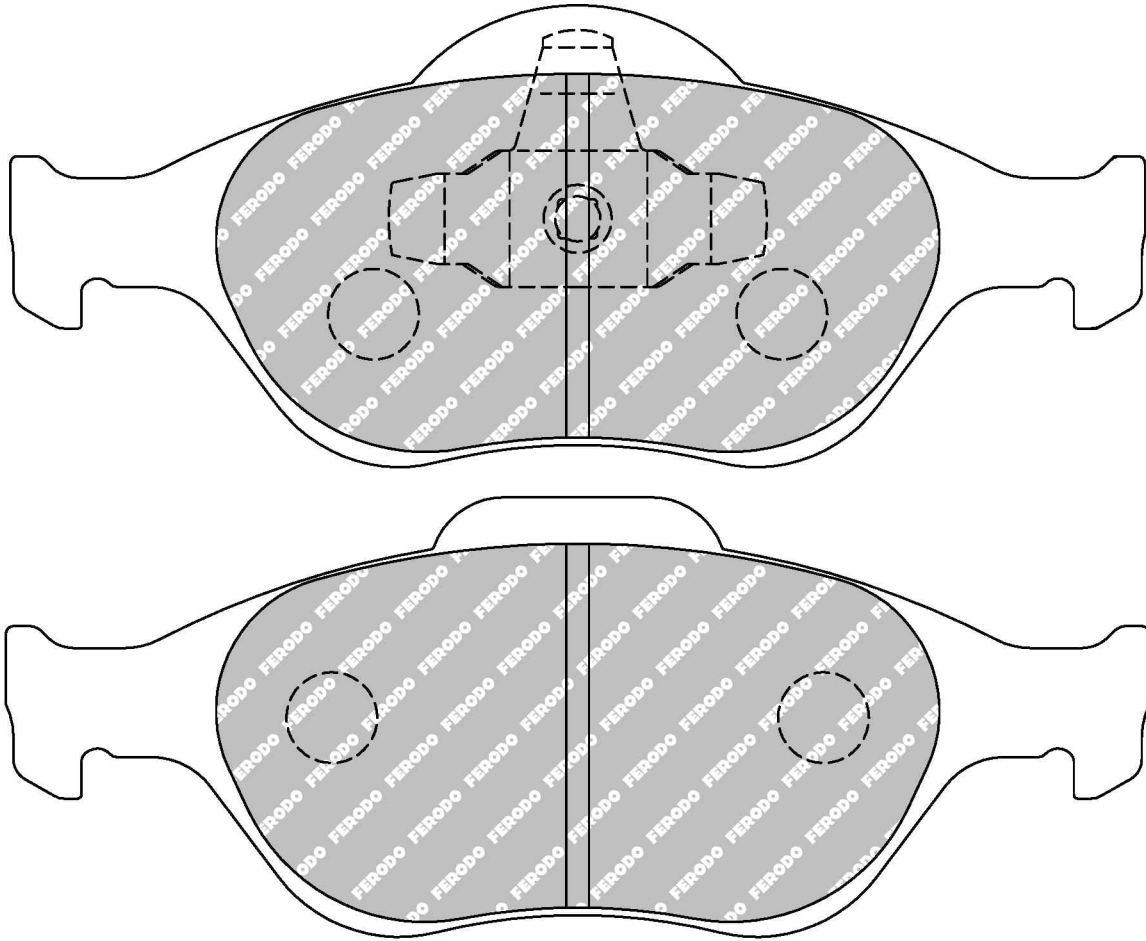

MATERIAL AVAILABILITY						
H	C	R	W	WB	Z	ZB
✓		✓				

CROSS REFERENCE	
MINTEX	MDB2314
WVA	23202 18,50

FCP1399

WVA No: 23954 19,00 (Ex 23599)

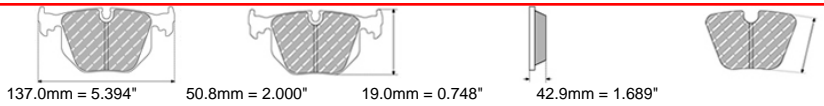

CITROEN Front, PEUGEOT Front

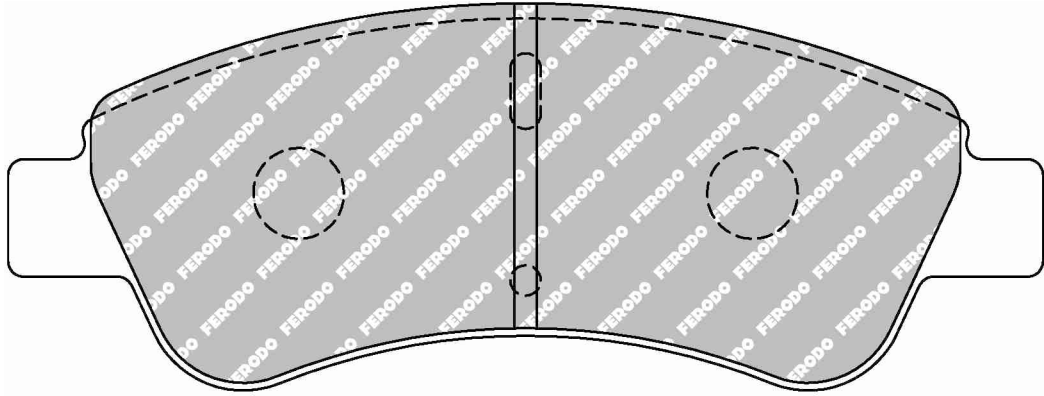

ALSO AVAILABLE		
SHAPE	TH. MM	NOTES
FRP3146	17.2	

MATERIAL AVAILABILITY						
H	C	R	W	WB	Z	ZB
✓		✓			✉	

CROSS REFERENCE	
MINTEX	MDB2283 (Ex 2183)
MINTEX	MDB2628
PAGID	8212
WVA	23954 19,00 (Ex 23599)

FCP1419

WVA No: 23581 18,70



SEAT Front, SKODA Front, VOLKSWAGEN Front

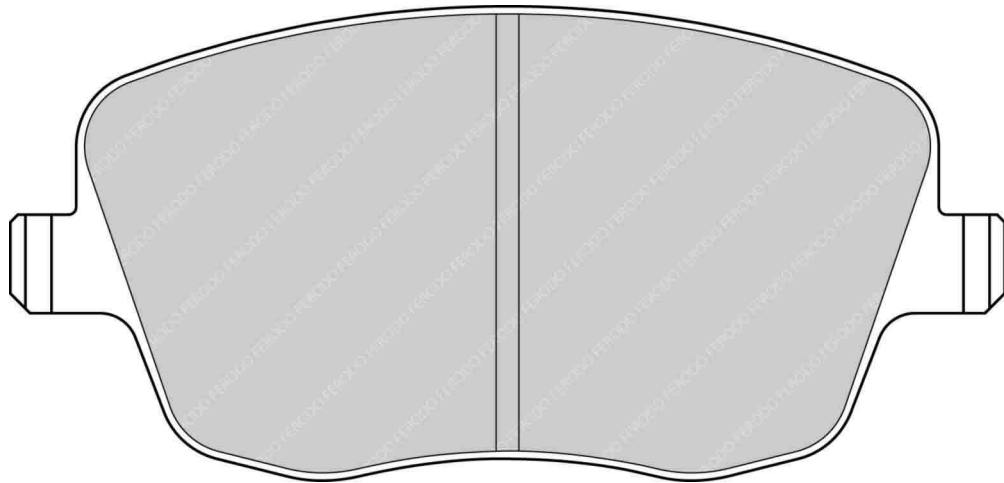

MATERIAL AVAILABILITY						
H	C	R	W	WB	Z	ZB
✓		✓				

CROSS REFERENCE	
MINTEX	MDB2294
WVA	23581 18,70

- ✓ Available
- ✗ Out of Range
- ✉ In Introduction
- ⚠ Exhausting
- ✉ Make to order

FCP1424

WVA No: 23225 17,00



131.7mm = 5.185"
131.7mm = 5.185"



55.4mm = 2.181"
52.3mm = 2.059"



16.0mm = 0.630"
16.0mm = 0.630"

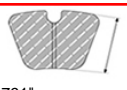

45.5mm = 1.791"
45.5mm = 1.791"

OPEL Front, VAUXHALL Front

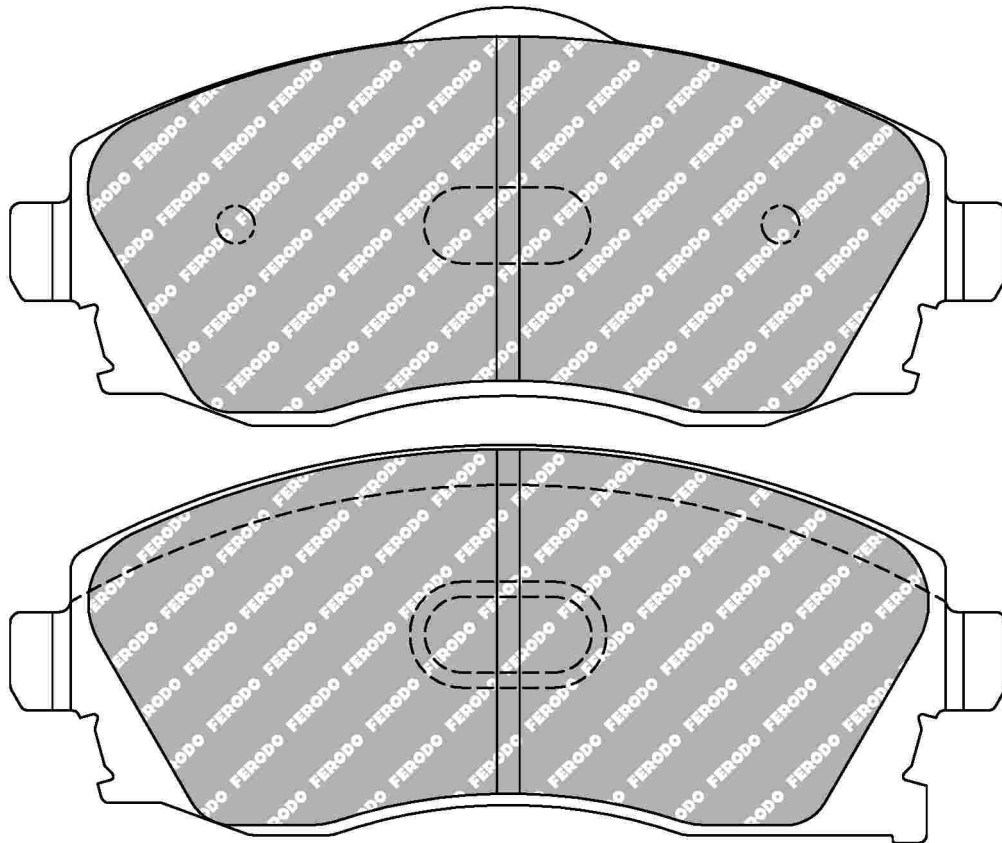

MATERIAL AVAILABILITY

H	C	R	W	WB	Z	ZB
✓						

CROSS REFERENCE

MINTEX	MDB2073
WVA	23225 17,00

FCP1430



137.5mm = 5.413"



53.0mm = 2.087"



16.9mm = 0.665"



45.5mm = 1.791"

FMSI No: D526

INFINITI Front, NISSAN Front

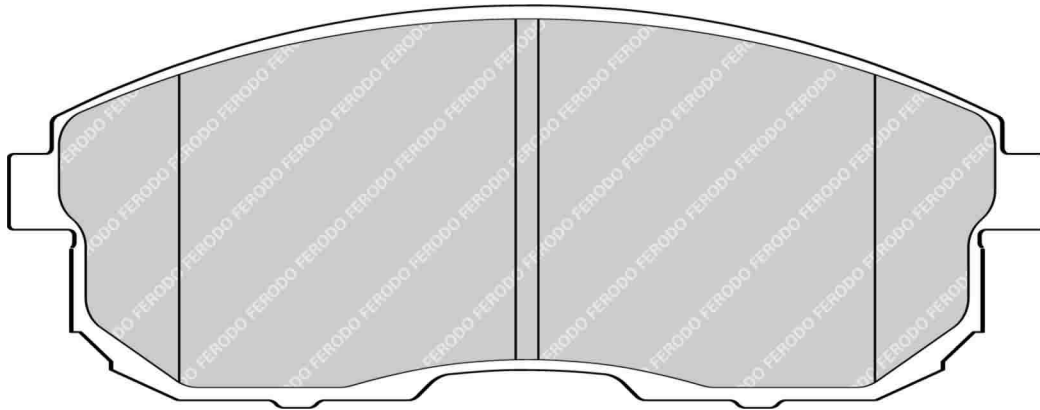

MATERIAL AVAILABILITY						
H	C	R	W	WB	Z	ZB
✓						

CROSS REFERENCE	
BREMBO	07.8300.20
BREMBO	07.8300.26
FMSI	D526
FMSI	D653
FMSI	D815
HAWK	HB412 0,665
MINTEX	MDB2847
MINTEX	MDB2967
PFC	0526.XX
PFC	0815.XX

FCP1436



129.0mm = 5.079"

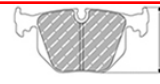

55.0mm = 2.165"



16.2mm = 0.638"



48.0mm = 1.890"

WVA No: 23566 17,20

FMSI No: D617

ACURA Front, HONDA Front

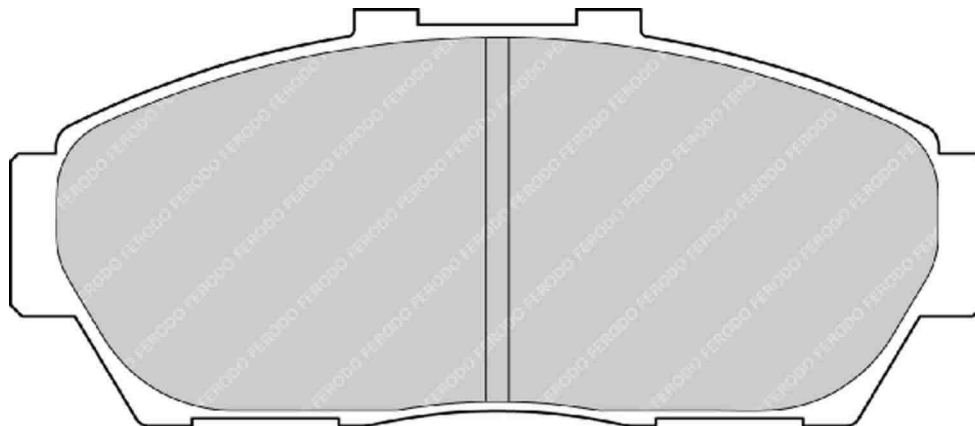

MATERIAL AVAILABILITY						
H	C	R	W	WB	Z	ZB
✉						

CROSS REFERENCE	
BREMBO	07.8300.33
FMSI	D617
HAWK	HB245 0,631
PFC	0617.XX
WVA	23566 17,20

✓ Available
 ✗ Out of Range
 ⓘ In Introduction
 ⚠ Exhausting
 ✉ Make to order

FERODO
RACING
 Updated on 17th Aug 2018

3129

FCP1437

WVA No: 23513 16,80

FMSI No: D707



117.0mm = 4.606"



59.0mm = 2.323"



17.2mm = 0.677"



52.0mm = 2.047"

LEXUS Front, TOYOTA Front

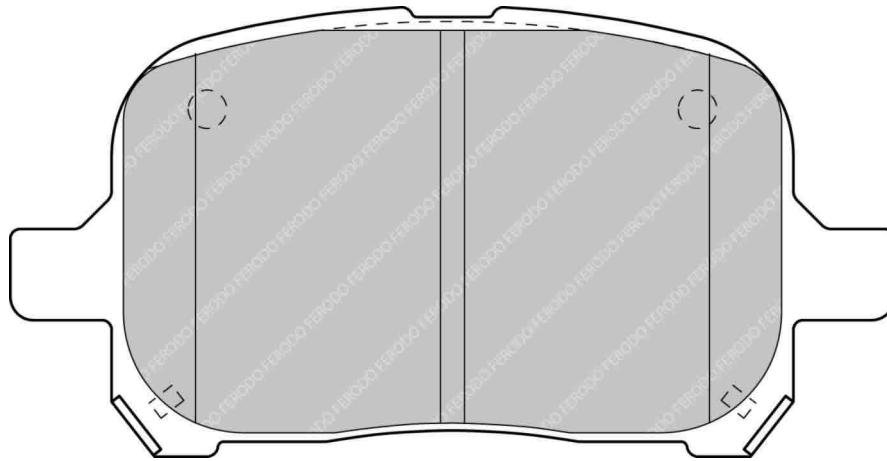

MATERIAL AVAILABILITY

H	C	R	W	WB	Z	ZB
!						

CROSS REFERENCE

BREMBO	07.8300.36
FMSI	D707
HAWK	HB320 0,669
MINTEX	MDB1921
PFC	0707.XX
WVA	23513 16,80

FCP1441

WVA No: 23245



155.4mm = 6.118"
156.5mm = 6.161"



70.8mm = 2.787"
67.9mm = 2.673"



18.3mm = 0.720"
18.3mm = 0.720"

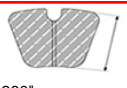

57.4mm = 2.260"
57.4mm = 2.260"

RENAULT Front

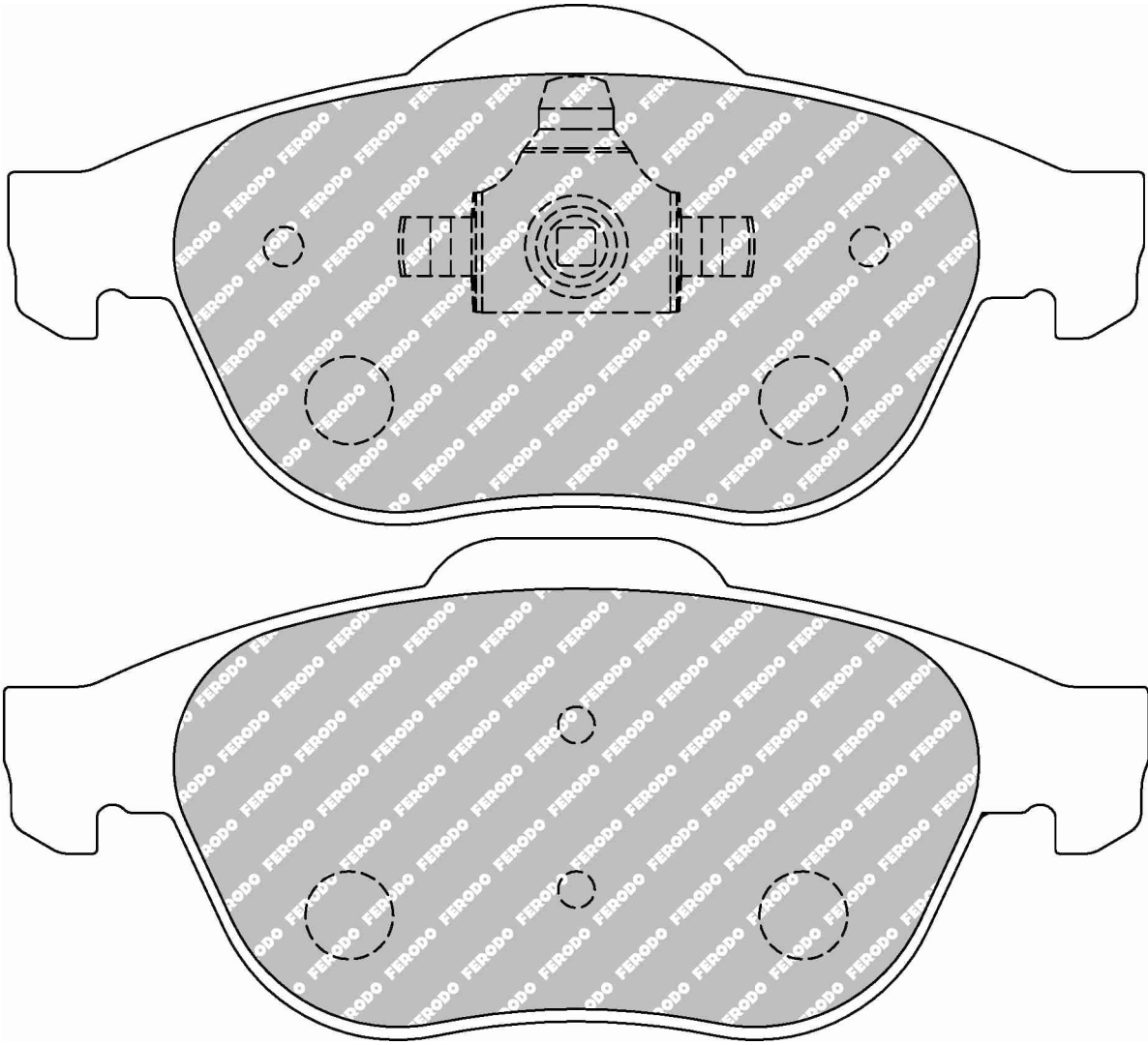

MATERIAL AVAILABILITY

H	C	R	W	WB	Z	ZB
✓						

CROSS REFERENCE

EBC	DP1958
MINTEX	MDB2224
MINTEX	MDB2225
OE Renault	7701206599
WVA	23245

✓ Available ⚠ Exhausting
 ✗ Out of Range 📦 Make to order
 ⓘ In Introduction

FERODO
RACING
 Updated on 17th Aug 2018

3131

FCP1444

WVA No: 23178 18,00



135.2mm = 5.323"



52.0mm = 2.047"



16.0mm = 0.630"

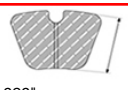

49.0mm = 1.929"

HONDA Front

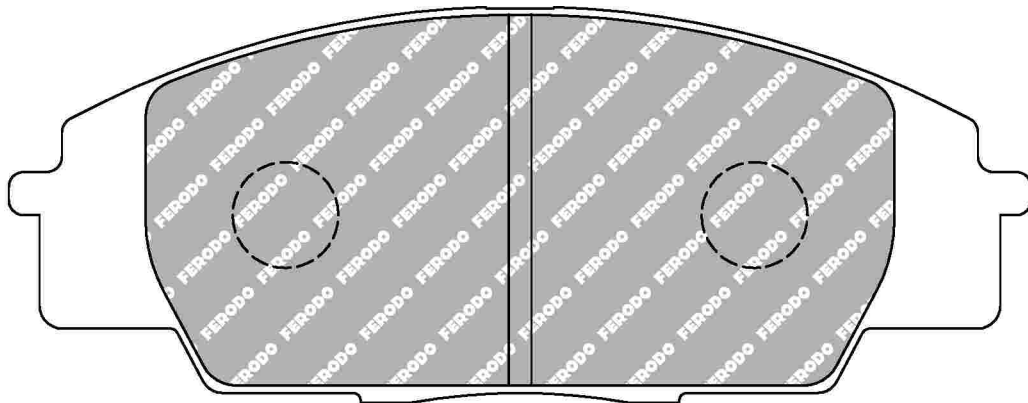

MATERIAL AVAILABILITY						
H	C	R	W	WB	Z	ZB
✓		✓	✓			

CROSS REFERENCE	
BREMBO	07.8301.90
MINTEX	MDB2044
PFC	0829
WVA	23178 18,00

FCP1456

WVA No: 23524



119.55mm = 4.707"

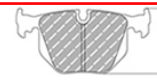

78.6mm = 3.094"



17.1mm = 0.673"



55.4mm = 2.181"

LEXUS Front, TOYOTA Front

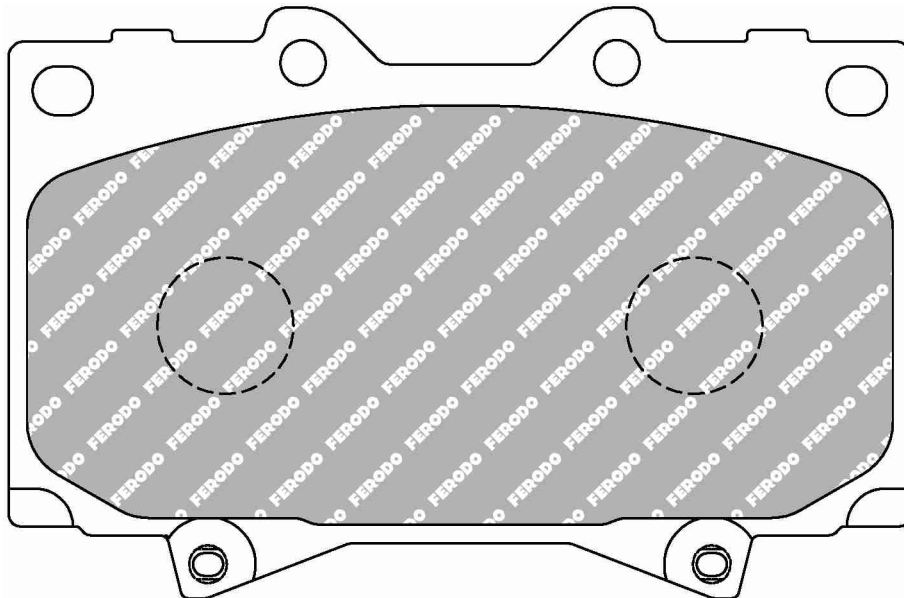

MATERIAL AVAILABILITY						
H	C	R	W	WB	Z	ZB
✓						

CROSS REFERENCE	
BREMBO	P83 048
WVA	23524

FCP1457

WVA No: 23539

FMSI No: D606

LEXUS Rear, TOYOTA Rear

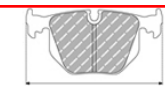

123.25mm = 4.852"

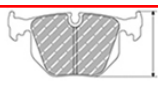

45.6mm = 1.795"



17.5mm = 0.689"

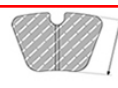

38.4mm = 1.512"

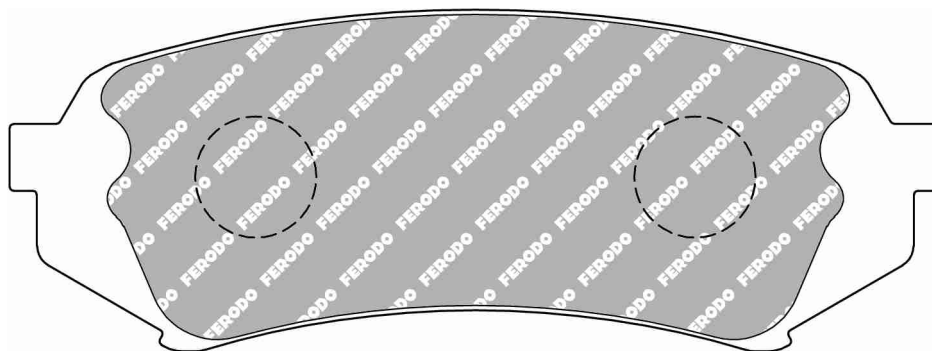

MATERIAL AVAILABILITY						
H	C	R	W	WB	Z	ZB
✓						

CROSS REFERENCE	
BREMBO	P83 049
EBC	DP4993
FMSI	D606
WVA	23539

FCP1459

WVA No: 20046 15,30

SUBARU Front, SUZUKI Front

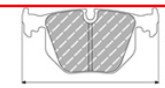

130.9mm = 5.154"

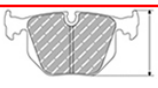

44.5mm = 1.752"



15.3mm = 0.602"



37.7mm = 1.484"

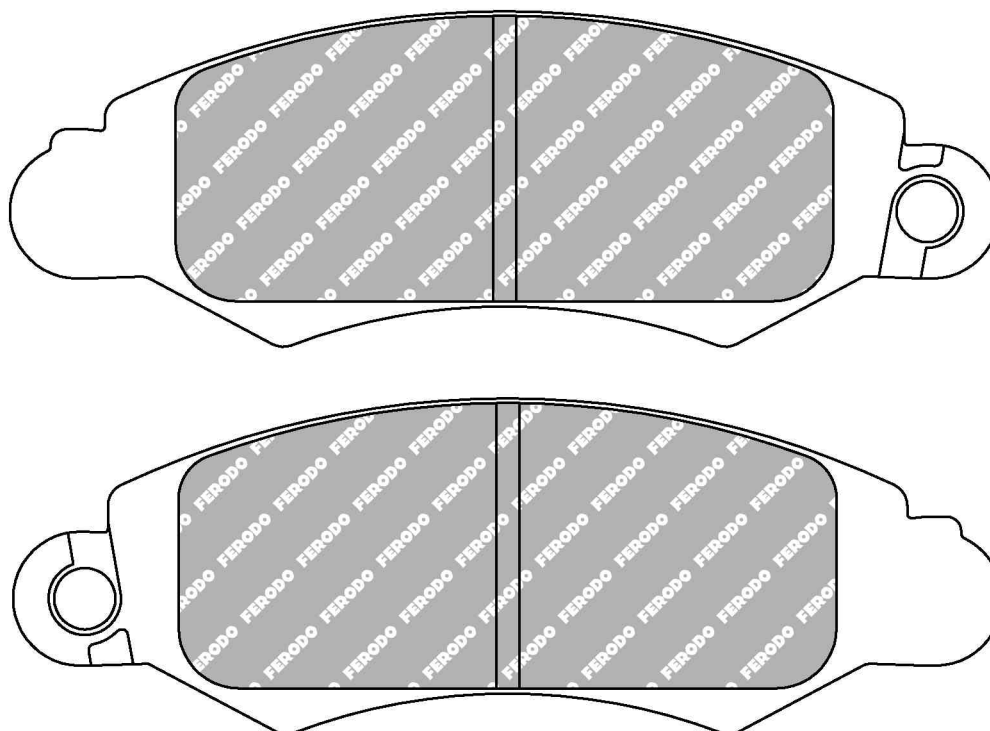

MATERIAL AVAILABILITY						
H	C	R	W	WB	Z	ZB
		✉				

CROSS REFERENCE	
MINTEX	MDB2003
WVA	20046 15,30

- ✓ Available
- ✗ Out of Range
- ✉ In Introduction
- ⚠ Exhausting
- ✉ Make to order

FCP1466

WVA No: 23705 17,10 - 24288 17,70&17,90

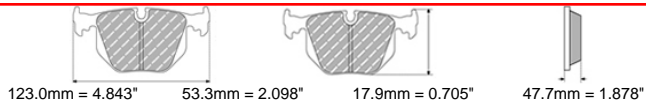

ABARTH Front, ALFA ROMEO Front, FIAT Front, OPEL Front

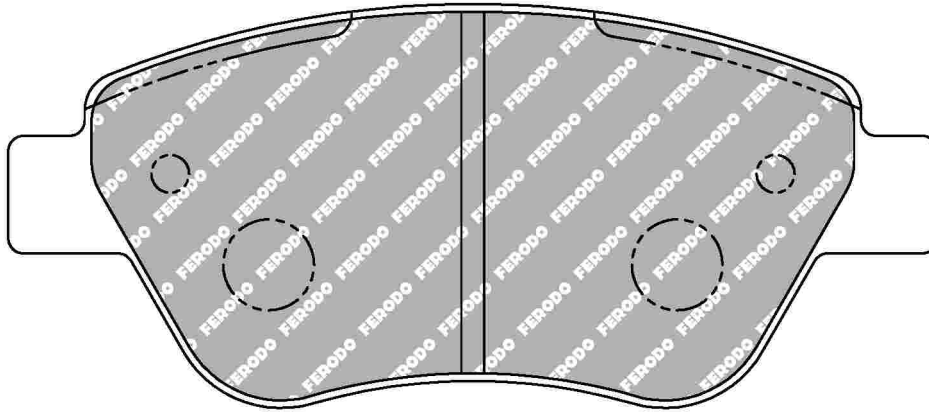

MATERIAL AVAILABILITY						
H	C	R	W	WB	Z	ZB
✓		✉			✉	

CROSS REFERENCE	
MINTEX	MDB2239
MINTEX	MDB2644
MINTEX	MDB3193
WVA	23705 17,10 - 24288 17,70&17,90

FCP1467

WVA No: 23708 18,40

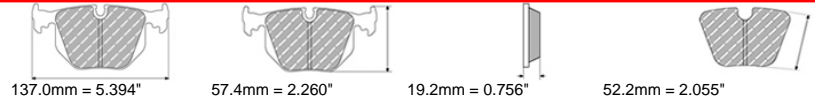

ABARTH Front, CITROEN Front, FIAT Front, LANCIA Front, OPEL Front, PEUGEOT Front

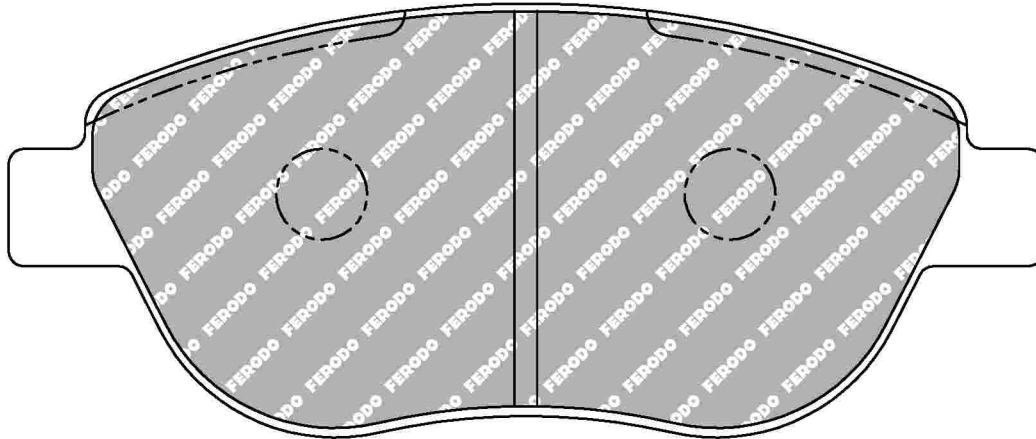

MATERIAL AVAILABILITY						
H	C	R	W	WB	Z	ZB
✓		✓			✓	

CROSS REFERENCE	
BREMBO	07.8301.79
MINTEX	MDB2240
WVA	23708 18,40

FCP1468

WVA No: 23711 18,40



151.0mm = 5.945"



57.5mm = 2.264"



19.2mm = 0.756"

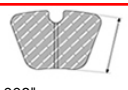

51.0mm = 2.008"

ALFA ROMEO Front, FIAT Front, LANCIA Front

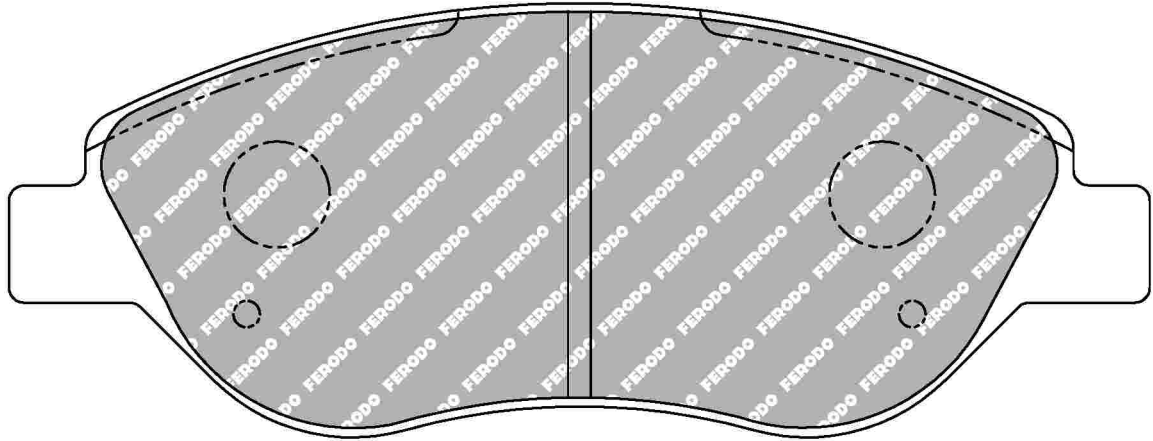

MATERIAL AVAILABILITY						
H	C	R	W	WB	Z	ZB
✓		✓				

CROSS REFERENCE	
BREMBO	07.8301.80
MINTEX	MDB2241
WVA	23711 18,40

FCP1469

WVA No: 23714 15,80



95.0mm = 3.740"



43.0mm = 1.693"



16.5mm = 0.650"

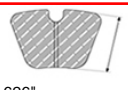

41.3mm = 1.626"

ALFA ROMEO Rear, FIAT Rear, LANCIA Rear, PEUGEOT Rear

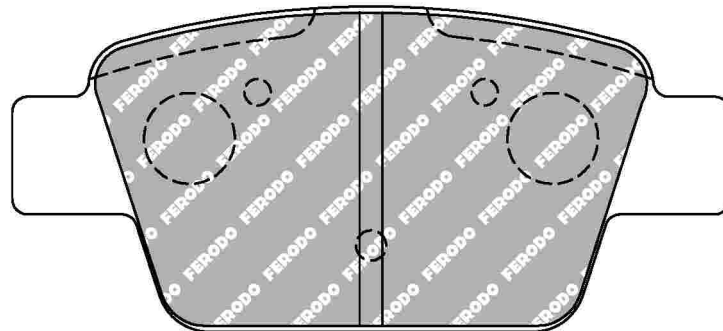

MATERIAL AVAILABILITY						
H	C	R	W	WB	Z	ZB
✓		✓				

CROSS REFERENCE	
MINTEX	MDB2238
WVA	23714 15,80

FCP1483

WVA No: 21282 17,20

FMSI No: D683

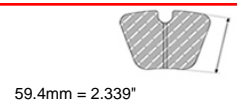
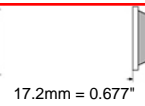
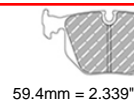
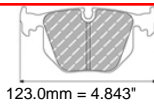

BMW Rear, LAND ROVER Rear

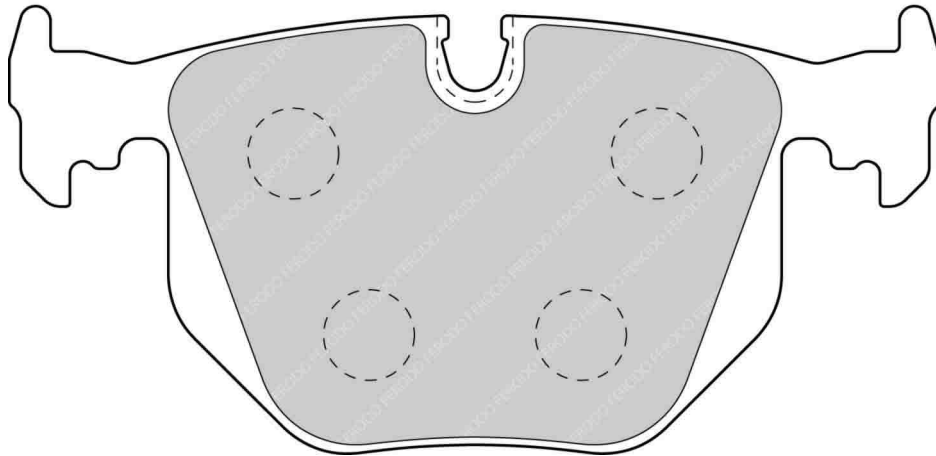
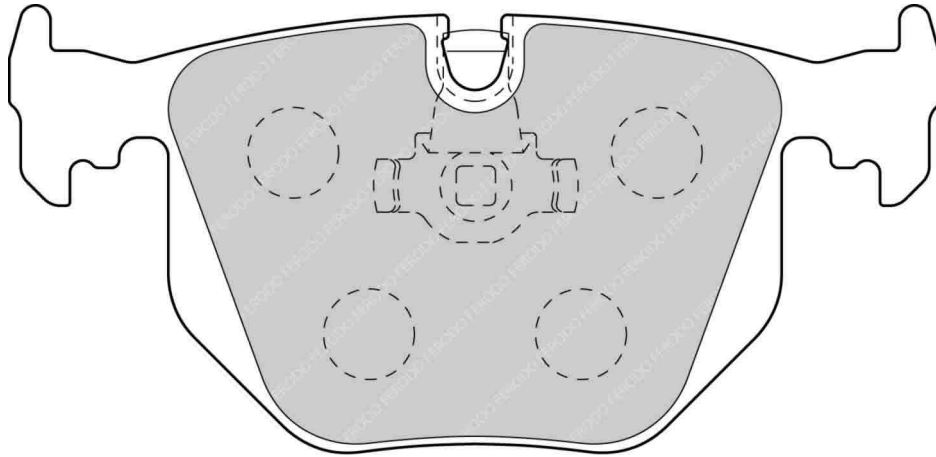

ALSO AVAILABLE

SHAPE	TH. MM	NOTES
FCP857	17	Different Spring clip

MATERIAL AVAILABILITY

H	C	R	W	WB	Z	ZB
✓		✉	✉		✉	

CROSS REFERENCE

FMSI	D683
HAWK	HB518 0,642
MINTEX	MDB2004
PAGID	2685
PFC	0548
WVA	21282 17,20

FCP1491

WVA No: 20961 16,00



87.4mm = 3.441"

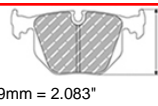

52.9mm = 2.083"



16.0mm = 0.630"

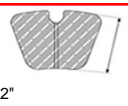

40.7mm = 1.602"

AUDI Rear, CITROEN Rear, PEUGEOT Rear, PORSCHE Rear, RENAULT Rear, SEAT Rear, SKODA Rear, VOLKSWAGEN Rear

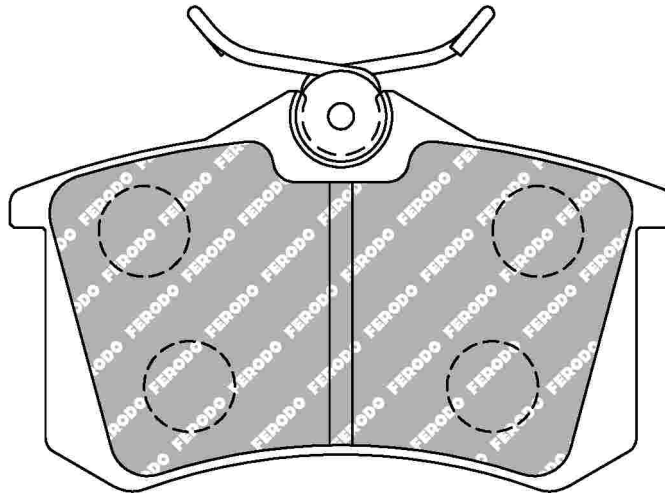

ALSO AVAILABLE		
SHAPE	TH. MM	NOTES
FCP541	15	

MATERIAL AVAILABILITY						
H	C	R	W	WB	Z	ZB
✓			✓			

CROSS REFERENCE	
MINTEX	MDB1377
MINTEX	MDB2256
OE AUDI	8E0698451D
OE AUDI	8E0698451E
OE Renault	440600364R
OE Renault	440602070R
OE Renault	440607960R
OE Renault	6025371650
OE VOLKSWAGEN	1K0698451J
PAGID	1158
PAGID	T5075
PFC	0340-07-15-44
WVA	20961 16,00

✓ Available ⚠ Exhausting
 ✗ Out of Range 📦 Make to order
 📅 In Introduction

FCP1499

WVA No: 23281 18,00

FMSI No: D939



140.3mm = 5.524"
140.3mm = 5.524"



58.8mm = 2.315"
59.9mm = 2.358"



18.0mm = 0.709"
18.0mm = 0.709"

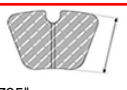

45.6mm = 1.795"
45.6mm = 1.795"

MINI Front

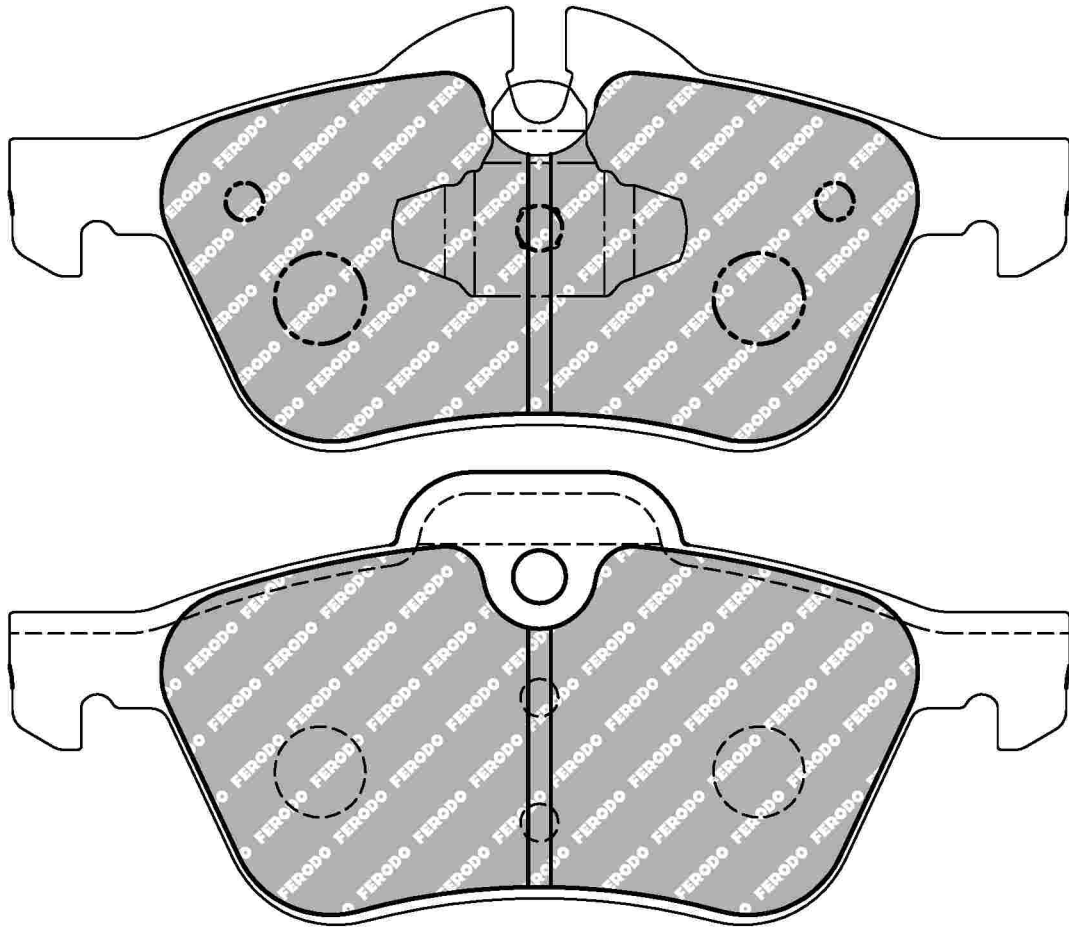

MATERIAL AVAILABILITY

H	C	R	W	WB	Z	ZB
✓		✓	✗			

CROSS REFERENCE

BREMBO	07.8301.88
FMSI	D939
HAWK	HB444 0,685
MINTEX	MDB2162
PAGID	2959
WVA	23281 18,00

FCP1501

WVA No: 23497 15,40



95.0mm = 3.740"
115.5mm = 4.547"



49.6mm = 1.953"
49.6mm = 1.953"



15.4mm = 0.606"
15.3mm = 0.602"

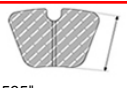

39.0mm = 1.535"
36.0mm = 1.417"

DAIHATSU Front

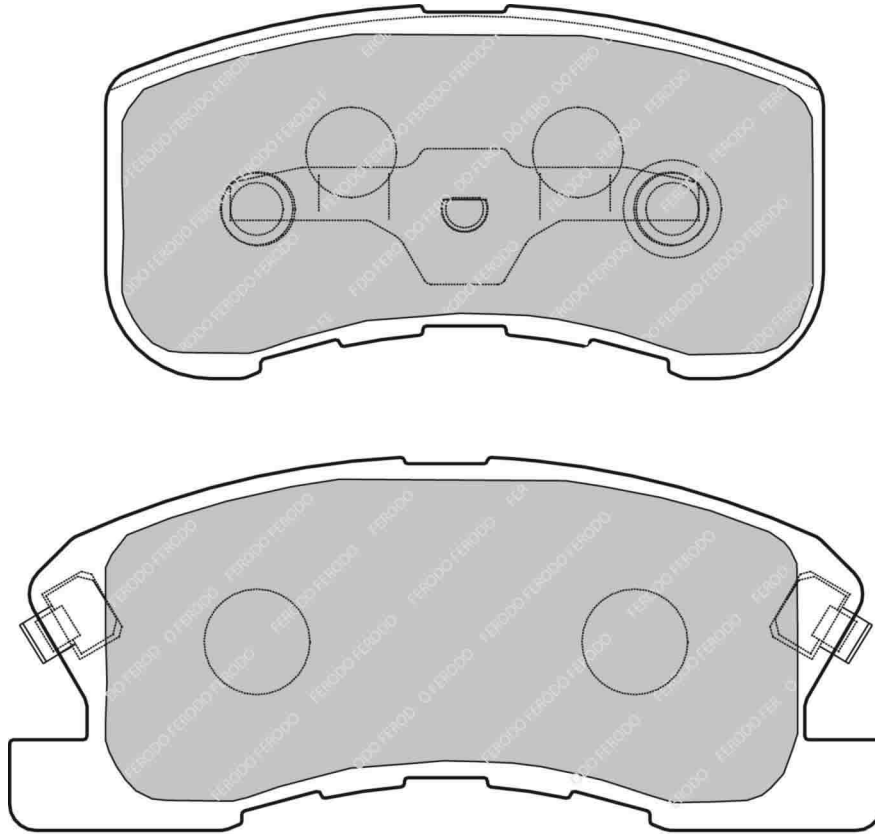

MATERIAL AVAILABILITY						
H	C	R	W	WB	Z	ZB

CROSS REFERENCE	
MINTEX	MDB1910
WVA	23497 15,40

Available
 Out of Range
 In Introduction
 Exhausting
 Make to order

FCP1520

WVA No: 23402 20,10 - 23403 20,10

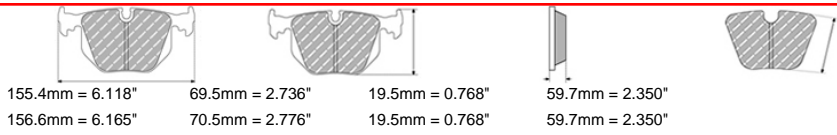

CHEVROLET Front, FIAT Front, OPEL Front, SAAB Front, VAUXHALL Front

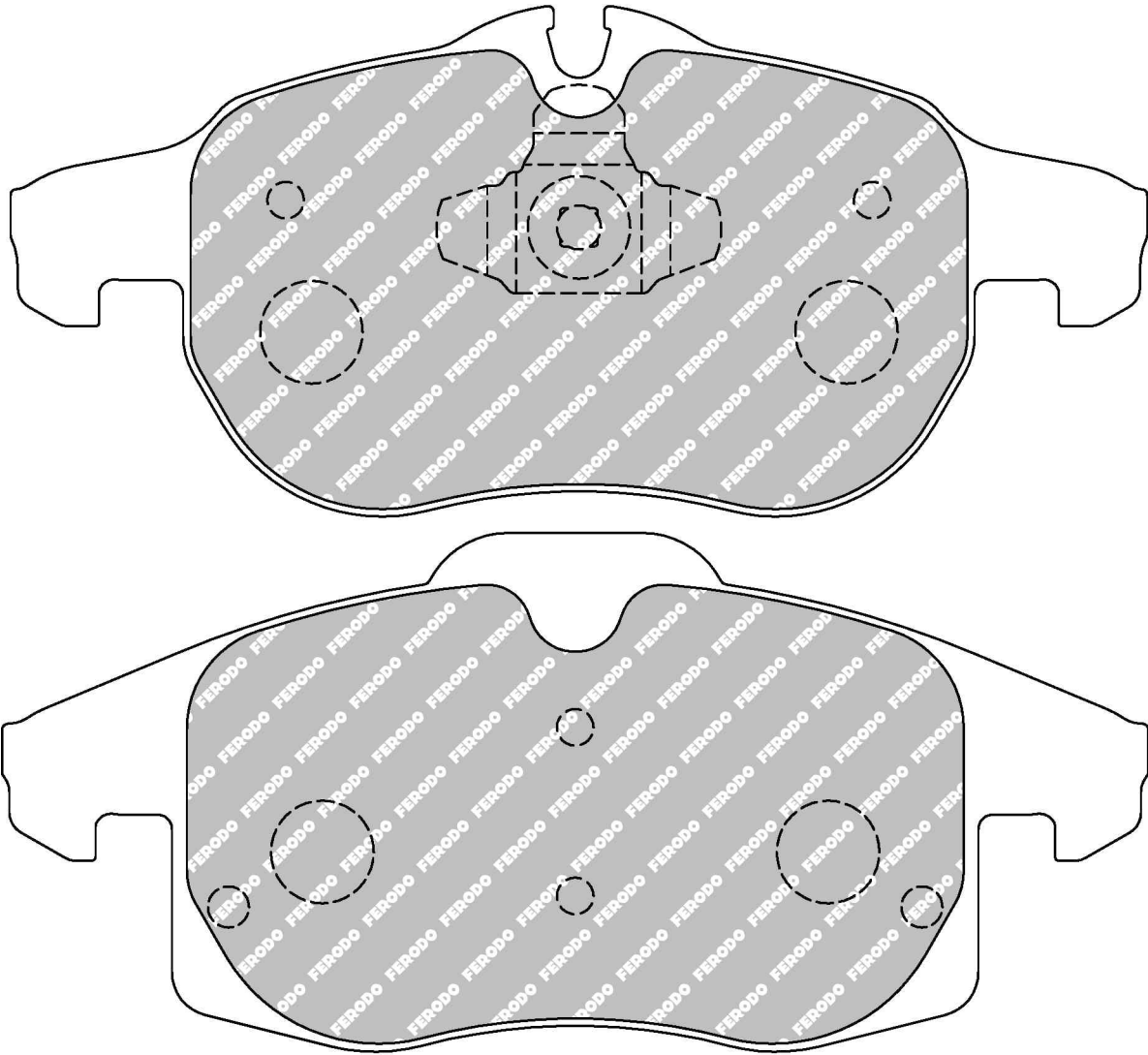

MATERIAL AVAILABILITY						
H	C	R	W	WB	Z	ZB
✓						

CROSS REFERENCE	
MINTEX	MDB2262
WVA	23402 20,10 - 23403 20,10

FCP1521

WVA No: 23417 15,20



95.5mm = 3.760"



42.8mm = 1.685"



15.1mm = 0.594"

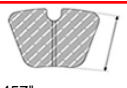

37.0mm = 1.457"

CHEVROLET Rear, CHRYSLER Rear, KIA Rear, OPEL Rear, VAUXHALL Rear

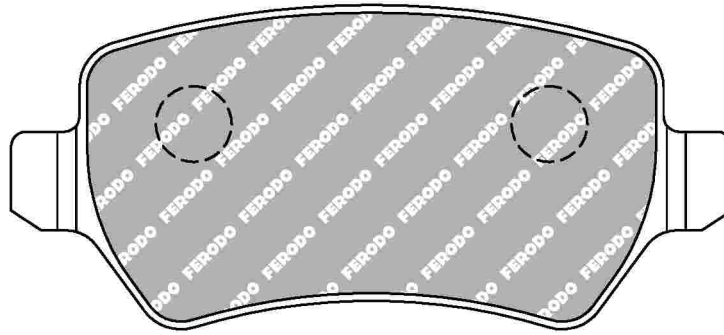

MATERIAL AVAILABILITY						
H	C	R	W	WB	Z	ZB
✓						

CROSS REFERENCE	
MINTEX	MDB2223
PAGID	8185
WVA	23417 15,20

FCP1528

WVA No: 23526 17,40

FMSI No: D817



117.8mm = 4.638"



58.0mm = 2.283"



18.2mm = 0.717"

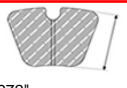

50.1mm = 1.972"

TOYOTA Front

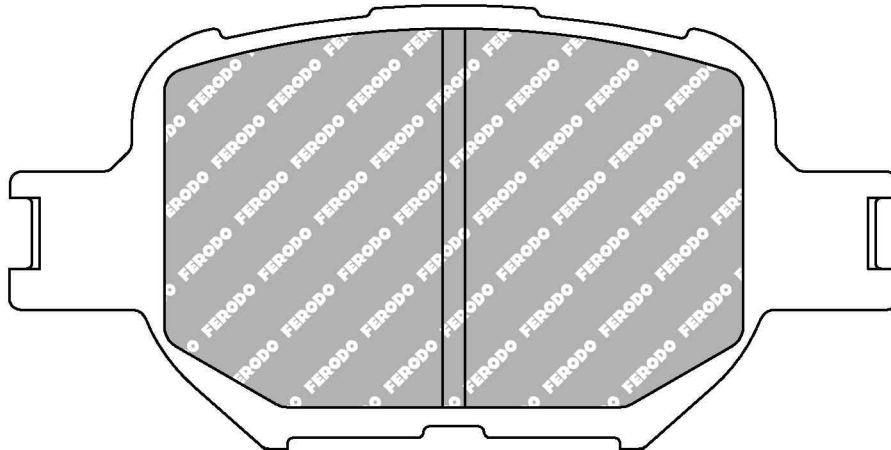

MATERIAL AVAILABILITY						
H	C	R	W	WB	Z	ZB
✓		✓				

CROSS REFERENCE	
FMSI	D817
HAWK	HB328 0,685
MINTEX	MDB2013
MINTEX	MDB2291
WVA	23526 17,40

✓ Available ⚠ Exhausting
 ✗ Out of Range 📦 Make to order
 📌 In Introduction

FCP1540

WVA No: 23482 16,50



123.1mm = 4.846"



52.0mm = 2.047"



15.8mm = 0.622"

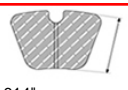

41.0mm = 1.614"

CHEVROLET Rear, FORD Rear, NISSAN Rear, OPEL Rear, RENAULT Rear, SAAB Rear, VAUXHALL Rear

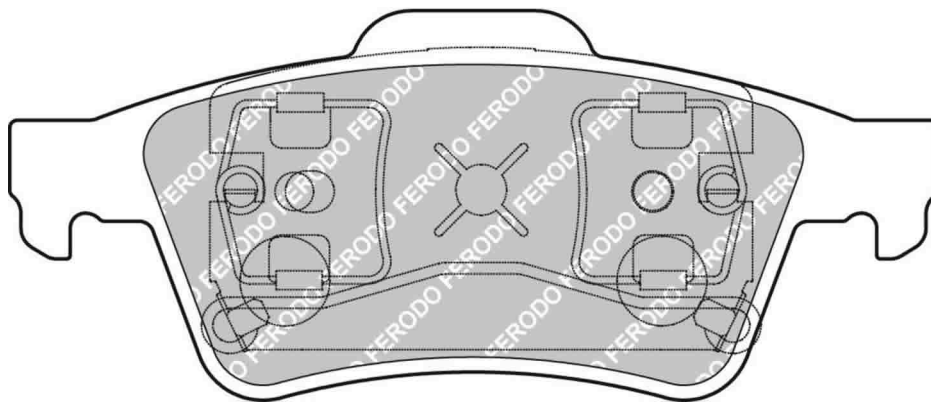
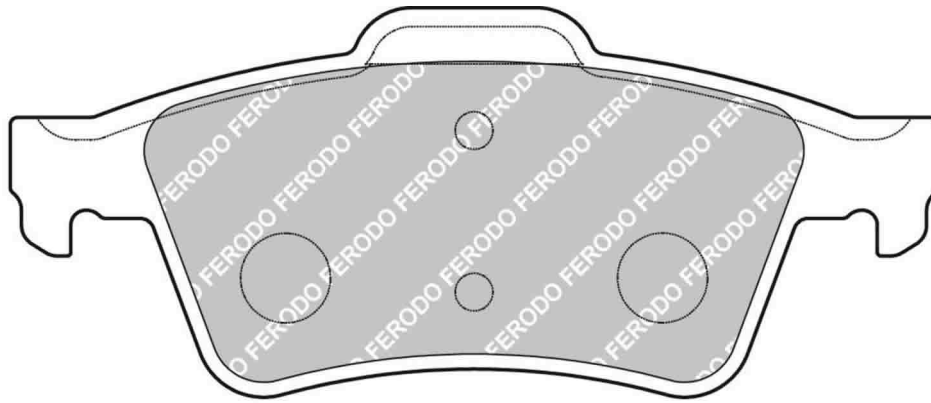

MATERIAL AVAILABILITY

H	C	R	W	WB	Z	ZB
✓						

CROSS REFERENCE

MINTEX	MDB2210
MINTEX	MDB2281
WVA	23482 16,50

FCP1543

WVA No: 23409 19,30



129.0mm = 5.079"



56.4mm = 2.220"



19.1mm = 0.752"

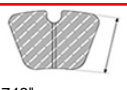

44.4mm = 1.748"

CITROEN Front

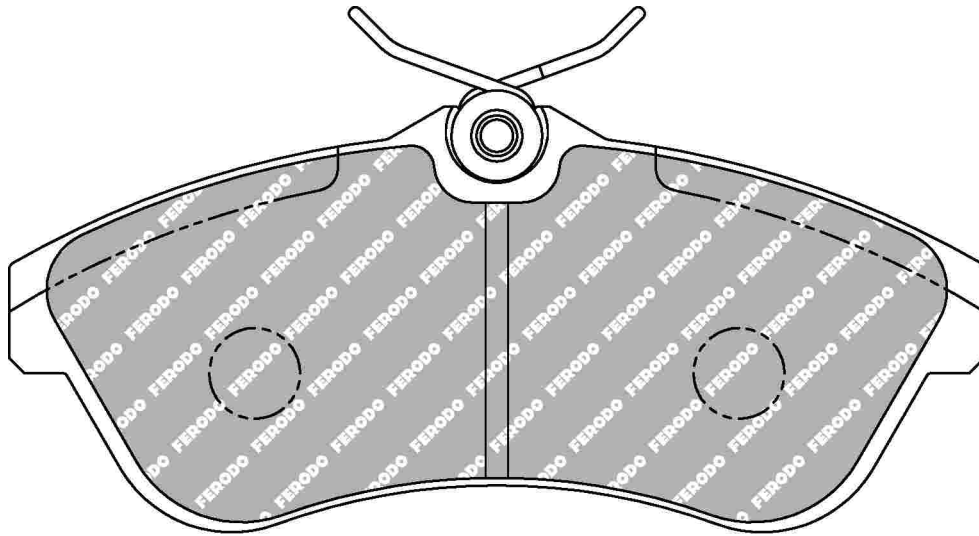

MATERIAL AVAILABILITY						
H	C	R	W	WB	Z	ZB
✓		✓				

CROSS REFERENCE	
BREMBO	07.8301.91
MINTEX	MDB2254
WVA	23409 19,30

FCP1553

WVA No: 24194 15,3



183.8mm = 7.236"

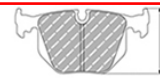

63.0mm = 2.480"



14.7mm = 0.579"



50.0mm = 1.969"

CHEVROLET Front, HOLDEN Front

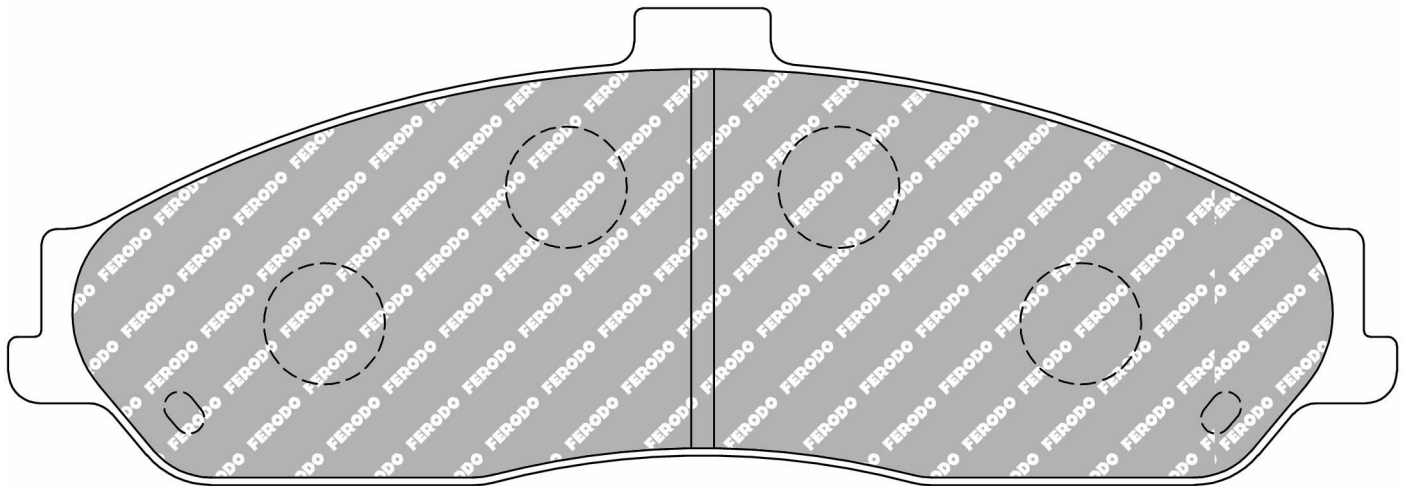

MATERIAL AVAILABILITY						
H	C	R	W	WB	Z	ZB
✓		✕	✕		✕	

CROSS REFERENCE	
MINTEX	MDB2213
PFC	0731
WVA	24194 15,3

- ✓ Available
- ✕ Out of Range
- ✕ Exhausting
- ✕ Make to order
- ✕ In Introduction

FCP1560

WVA No: 20410 12,90

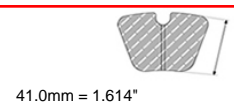
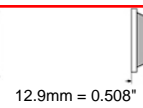
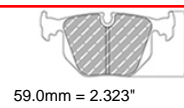
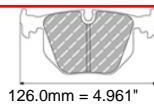

LOTUS Rear, OPEL Rear, VAUXHALL Rear

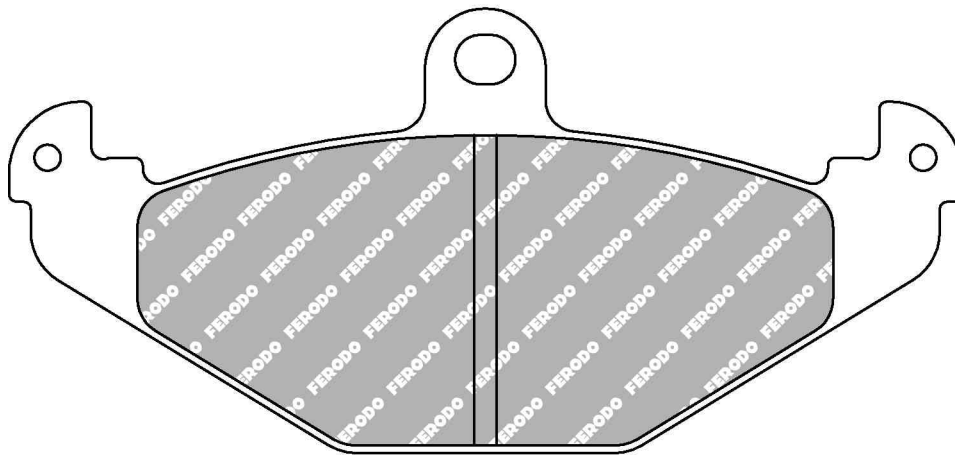

ALSO AVAILABLE

SHAPE	TH. MM	NOTES
FCP878	14.6	

MATERIAL AVAILABILITY

H	C	R	W	WB	Z	ZB
✓		✉	✓		✉	

CROSS REFERENCE

AP RACING	CP3915D33
MINTEX	MDB1891
PAGID	1682
WVA	20410 12,90

FCP1561

WVA No: 23142 15,00

FMSI No: D960

HONDA Front, MINI Front, NISSAN Front



119.8mm = 4.717"



73.7mm = 2.902"



15.0mm = 0.591"



55.6mm = 2.189"

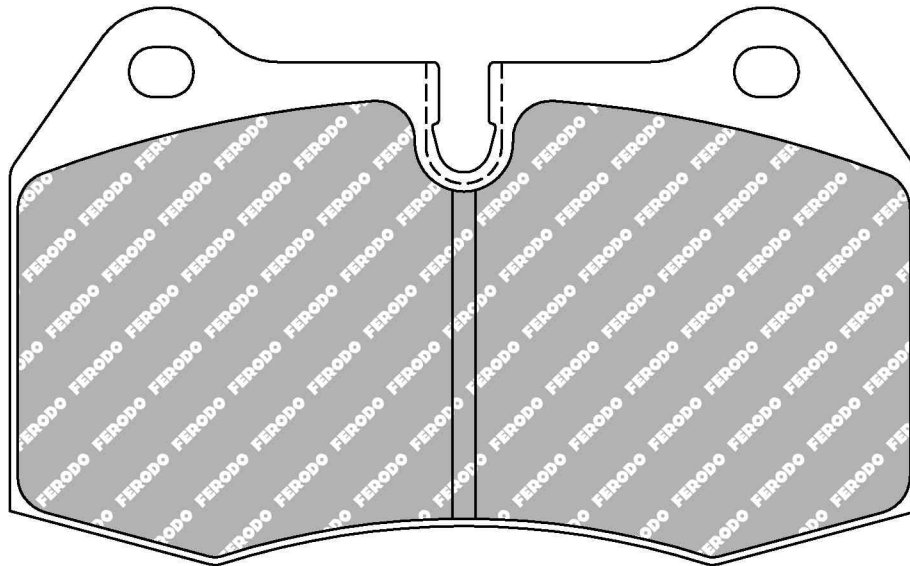

MATERIAL AVAILABILITY

H	C	R	W	WB	Z	ZB
✓		✓	✓		✓	

CROSS REFERENCE

CL BRAKES	4061
FMSI	D960
HAWK	HB545 0,564
MINTEX	MDB2341
PFC	0639
WVA	23142 15,00

✓ Available ⚠ Exhausting
 ✗ Out of Range 📦 Make to order
 📌 In Introduction

FCP1562

WVA No: 21580 14,30

FMSI No: D961

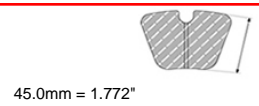
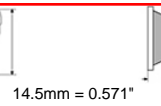
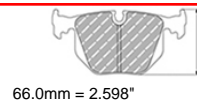
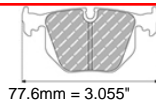

LOTUS Front, MASERATI Rear, MITSUBISHI Front / Rear, NISSAN Rear, OPEL Front, SUBARU Rear, VAUXHALL Front

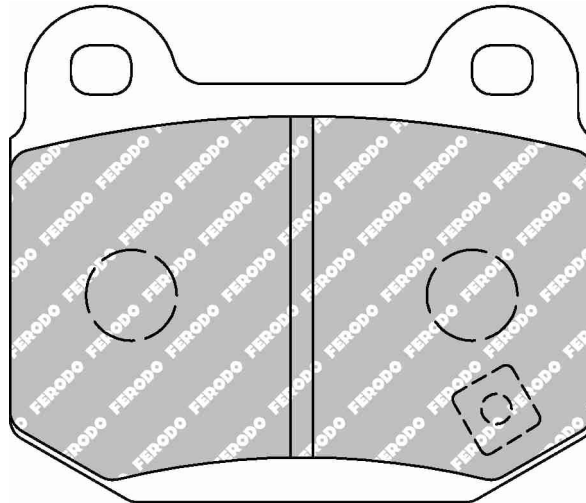

Replacing FCP1282

ALSO AVAILABLE		
SHAPE	TH. MM	NOTES
FCP116	16.5	different friction area
FRP3056		different friction area

MATERIAL AVAILABILITY						
H	C	R	W	WB	Z	ZB
✓	✓	✓	✓		✓	

CROSS REFERENCE	
ALCON	PNF0084X358.4
AP RACING	CP5119D50
BREMBO	07.5505.91
BREMBO	07.7858.30-40
CL BRAKES	4060
FMSI	D961
HAWK	HB180 0,56
MINTEX	MDB2342
PAGID	1587
PAGID	2593
PFC	0109
WVA	21580 14,30

FCP1563

WVA No: 24197

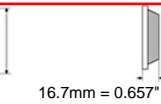
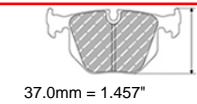
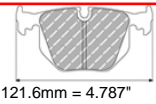

CHEVROLET Rear

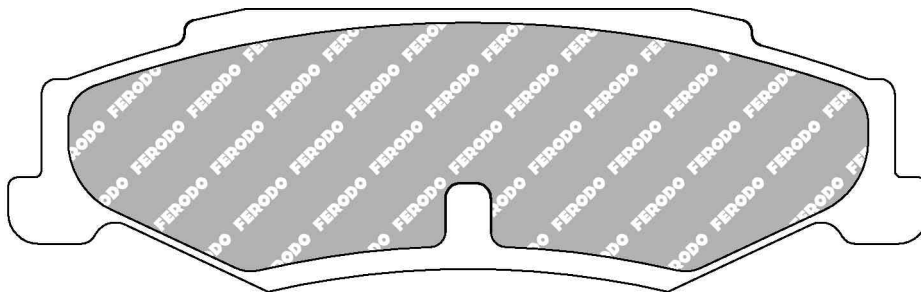

MATERIAL AVAILABILITY						
H	C	R	W	WB	Z	ZB
✗			✗		✗	

CROSS REFERENCE	
MINTEX	MDB2214
PAGID	T1685
PFC	0732
WVA	24197

FCP1568



156.5mm = 6.161"
156.5mm = 6.161"



67.5mm = 2.657"
62.0mm = 2.441"



17.8mm = 0.701"
18.2mm = 0.717"

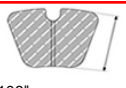

53.5mm = 2.106"
53.5mm = 2.106"

FMSI No: D970

FORD Front, MERCEDES Rear

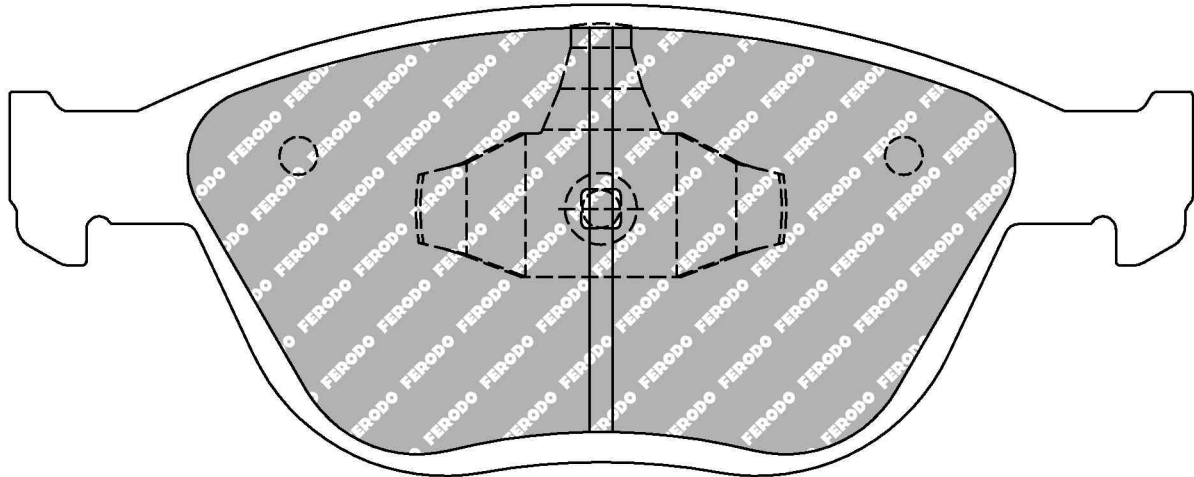
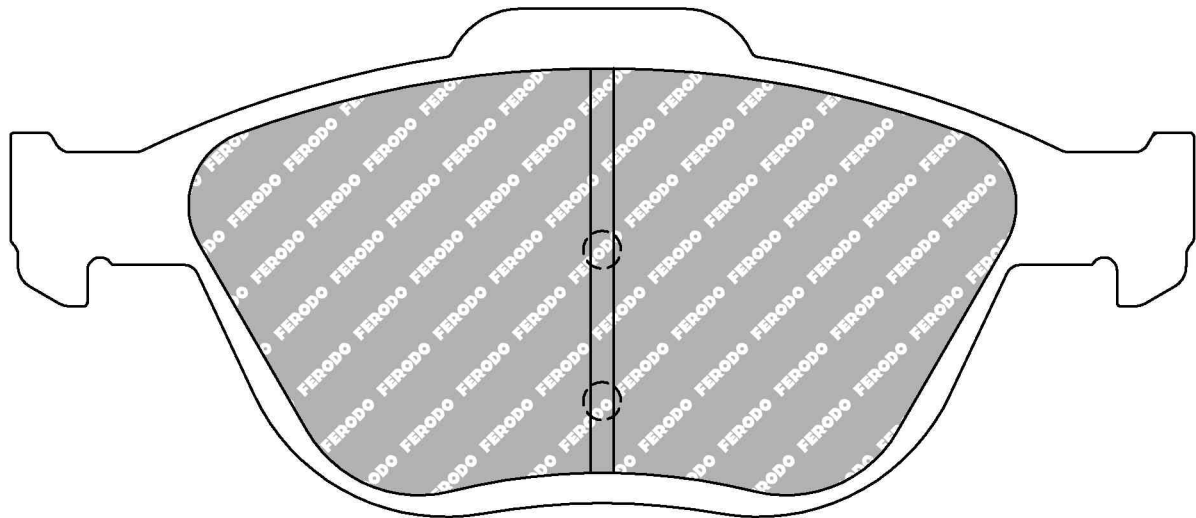

MATERIAL AVAILABILITY

H	C	R	W	WB	Z	ZB
✓		✓				

CROSS REFERENCE

BREMBO	07.8301.92
FMSI	D970
HAWK	HB449 0,679

✓ Available ⚠ Exhausting
 ✗ Out of Range 📦 Make to order
 ⓘ In Introduction

FERODO
RACING
 Updated on 17th Aug 2018

3147

FCP1573

WVA No: 23766 17,50



131.7mm = 5.185"



56.6mm = 2.228"



17.5mm = 0.689"



43.5mm = 1.713"

TOYOTA Front

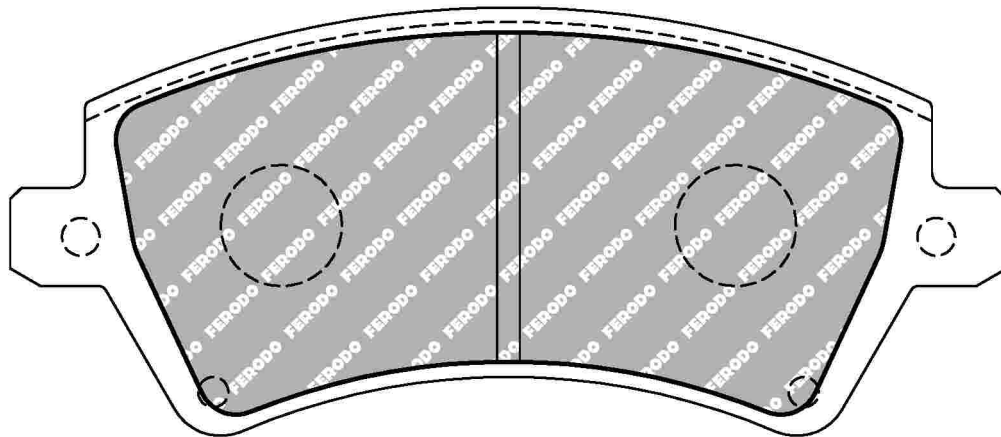

MATERIAL AVAILABILITY						
H	C	R	W	WB	Z	ZB
✓						

CROSS REFERENCE	
BREMBO	07.8301.89
MINTEX	MDB2257
WVA	23766 17,50

FCP1617

WVA No: 23973 16,80



116.4mm = 4.583"



52.3mm = 2.059"



17.5mm = 0.689"



46.7mm = 1.839"

NISSAN Front, RENAULT Front, SUZUKI Front

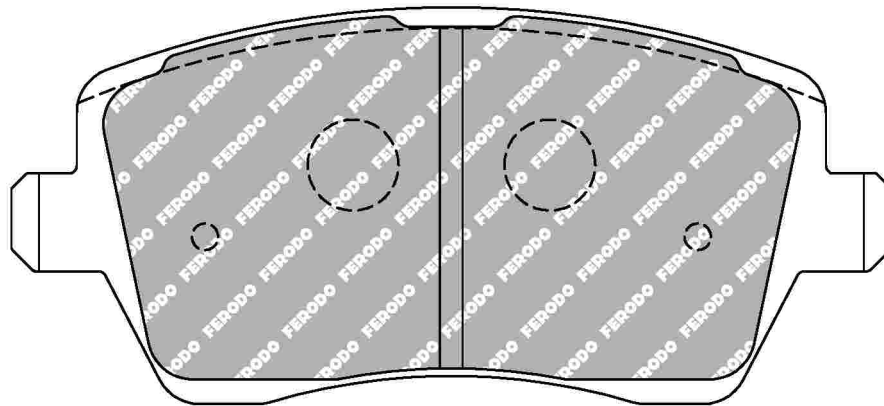

MATERIAL AVAILABILITY						
H	C	R	W	WB	Z	ZB
		✓	✉		✓	

CROSS REFERENCE	
MINTEX	MDB2595
WVA	23973 16,80

FCP1625

WVA No: 23692

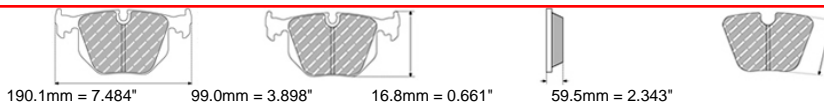

PORSCHE Front, VOLKSWAGEN Front

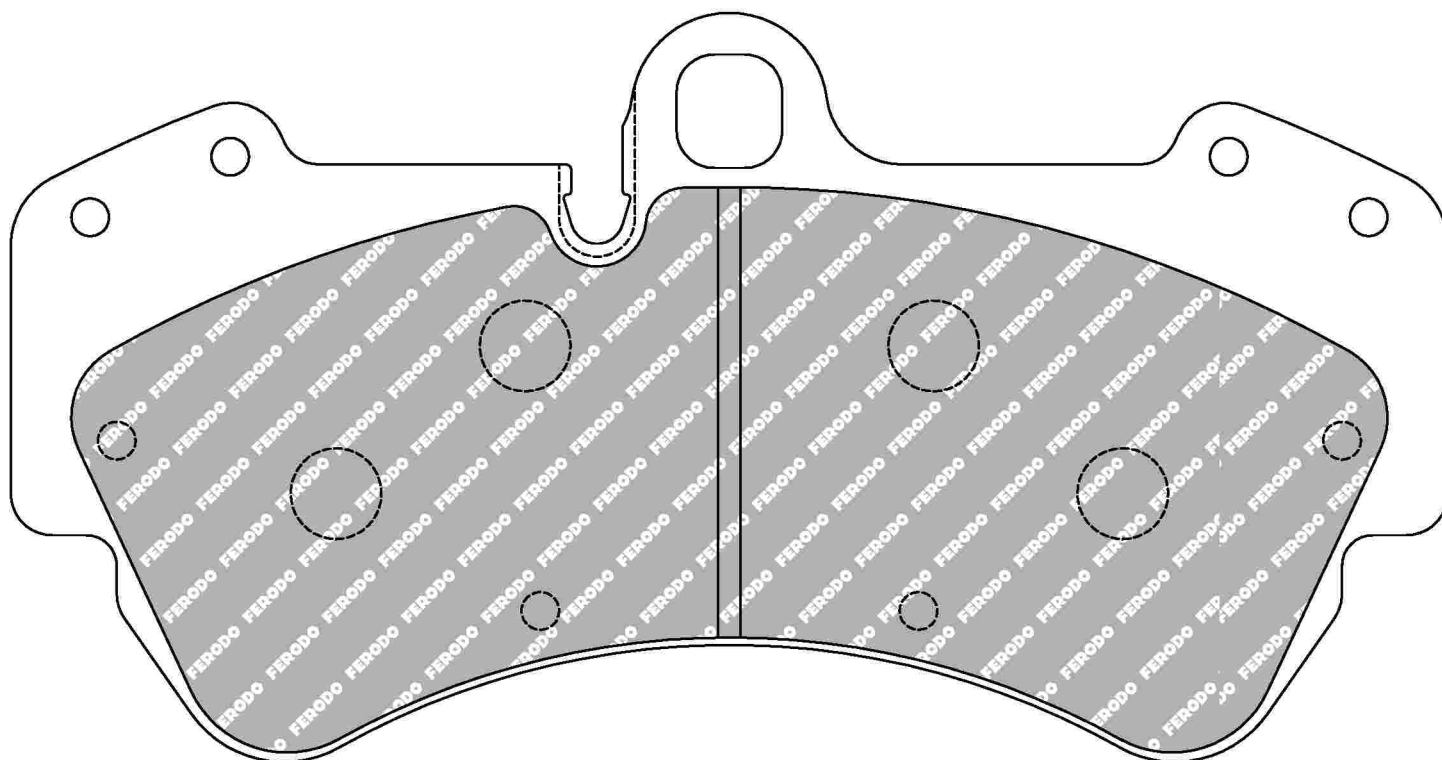

MATERIAL AVAILABILITY						
H	C	R	W	WB	Z	ZB
✓						

CROSS REFERENCE	
MINTEX	MDB2750
OE PORSCHE	955.351.939.00 / .01 / .02
OE VOLKSWAGEN	7L0698151 / B / D / H
OE VOLKSWAGEN	7L6698151 / C
WVA	23692

- ✓ Available
- ✗ Out of Range
- ⚠ Exhausting
- 📦 Make to order
- 👤 In Introduction

FCP1626

WVA No: 23693 16,20



190.1mm = 7.484"



106.3mm = 4.185"



16.8mm = 0.661"

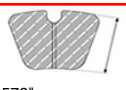

65.5mm = 2.579"

AUDI Front, PORSCHE Front, VOLKSWAGEN Front

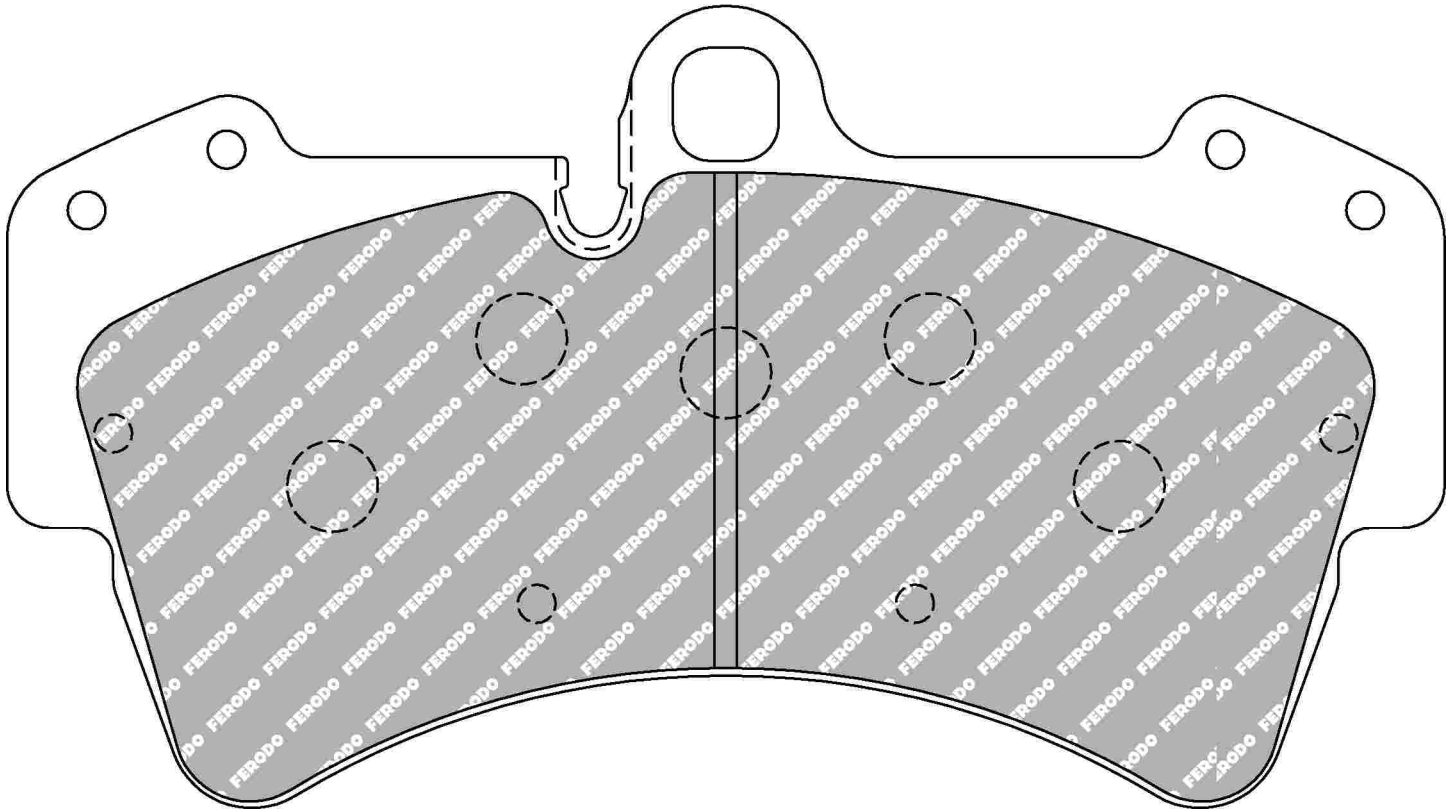

MATERIAL AVAILABILITY						
H	C	R	W	WB	Z	ZB
✓						

CROSS REFERENCE	
MINTEX	MDB2751
PAGID	2845
WVA	23693 16,20

FCP1628

WVA No: 23312 20,30

FMSI No: D918

BMW Front



155.3mm = 6.114"



68.5mm = 2.697"



19.2mm = 0.756"

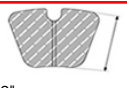

56.7mm = 2.232"

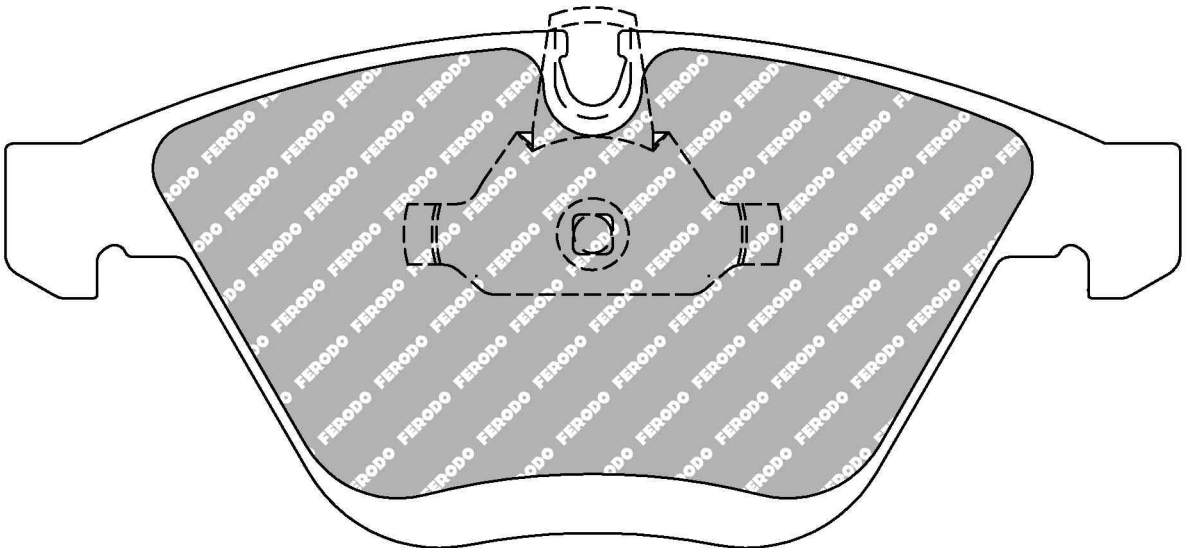
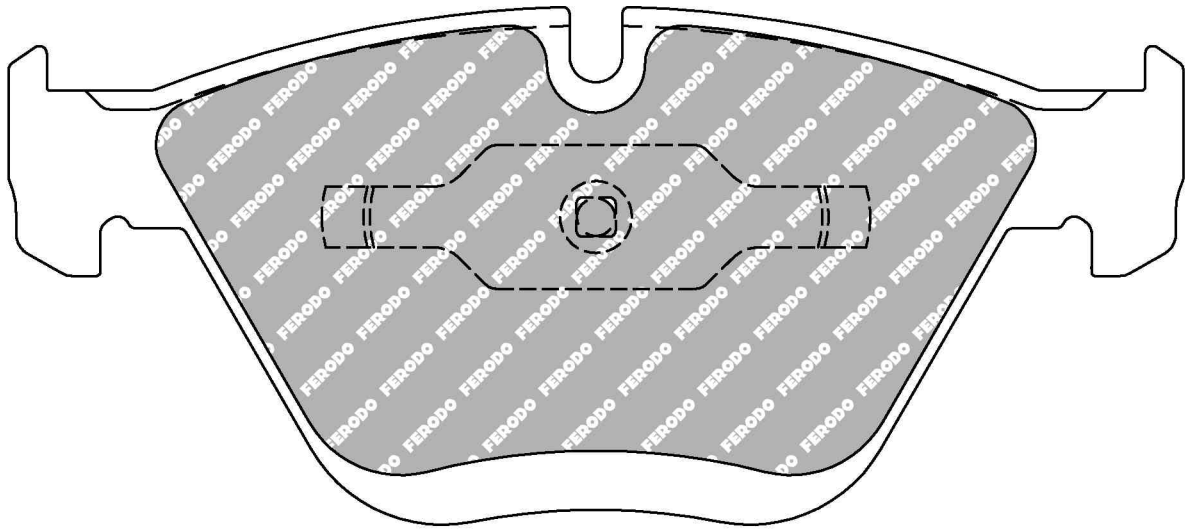

MATERIAL AVAILABILITY						
H	C	R	W	WB	Z	ZB
✓		✓	✓		✓	

CROSS REFERENCE	
ATE	13.0470-7167.2
FMSI	D918
MINTEX	MDB2418
WVA	23312 20,30

- ✓ Available
- ✗ Out of Range
- ⓘ In Introduction
- ⚠ Exhausting
- 📦 Make to order

FCP1629

WVA No: 23912 20,20 - 23801 20,2



155.3mm = 6.114"
156.5mm = 6.161"

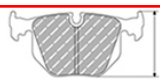

72.8mm = 2.866"
72.8mm = 2.866"



20.3mm = 0.799"
20.3mm = 0.799"

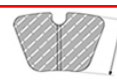

64.4mm = 2.535"
64.4mm = 2.535"

AUDI Front

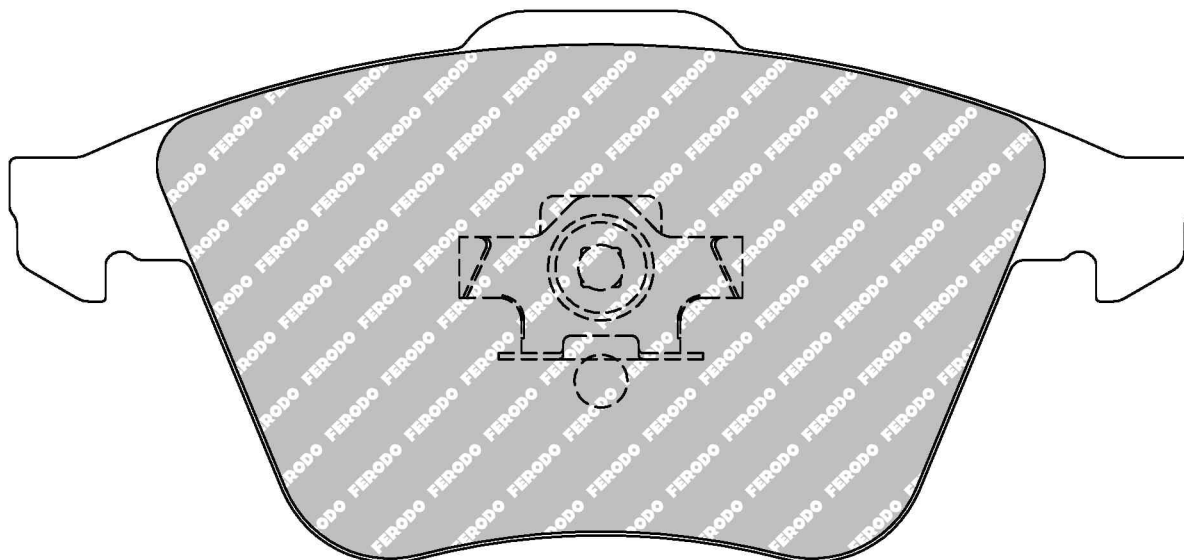
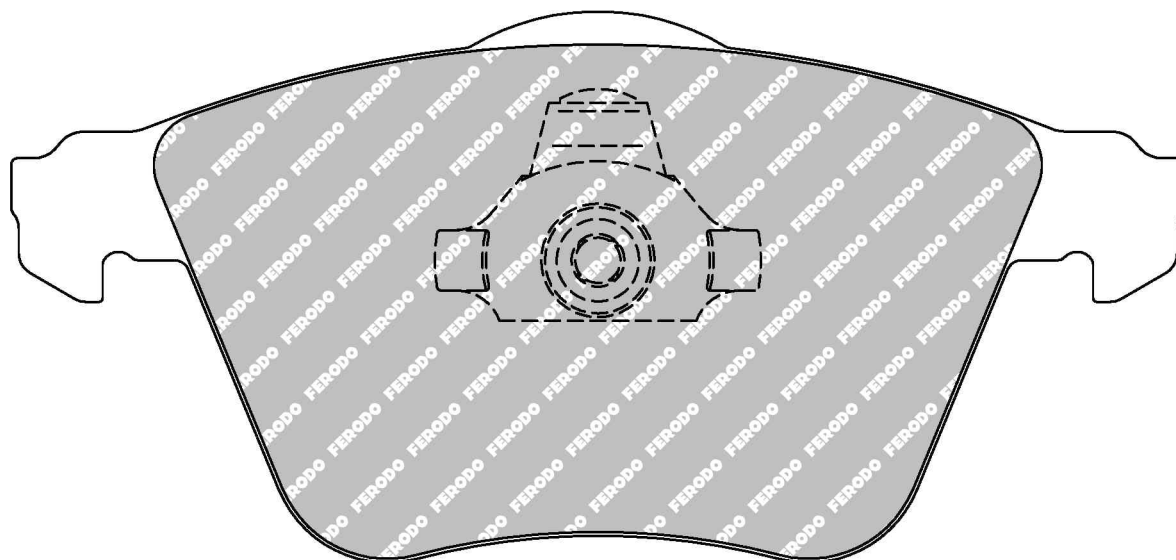

MATERIAL AVAILABILITY						
H	C	R	W	WB	Z	ZB
✓						

CROSS REFERENCE	
MINTEX	MDB2694
PAGID	8064
WVA	23912 20,20 - 23801 20,2

FCP1631

WVA No: 24142 20,60 - 24141 19,10

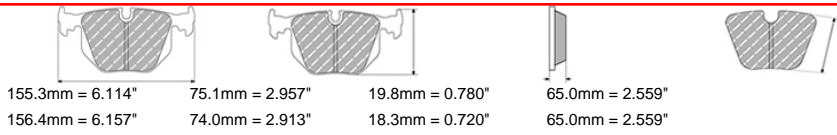

VOLVO Front

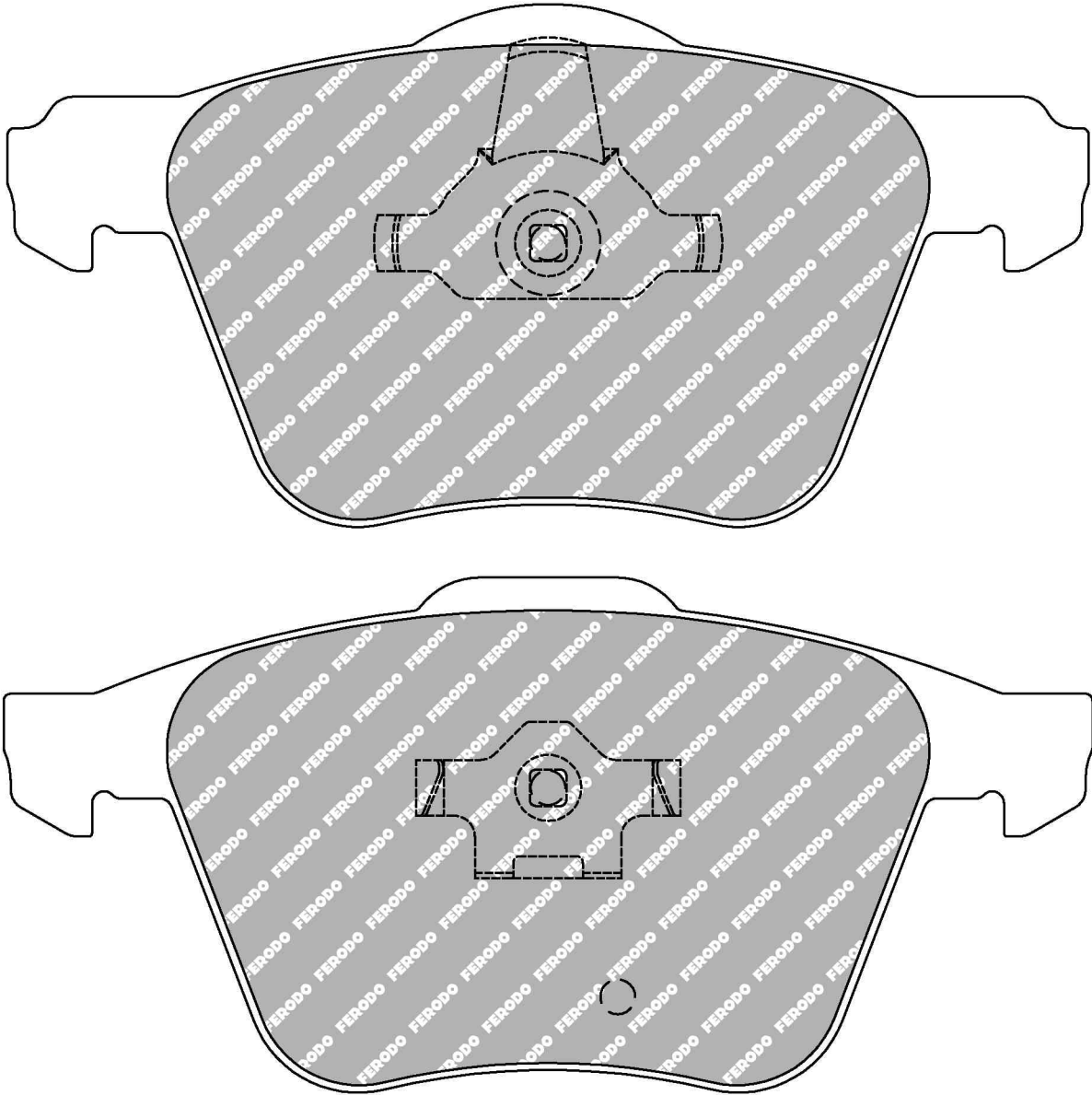

MATERIAL AVAILABILITY

H	C	R	W	WB	Z	ZB

CROSS REFERENCE

MINTEX	MDB2576
MINTEX	MDB2789
WVA	24142 20,60 - 24141 19,10

- Available
- Exhausting
- Out of Range
- Make to order
- In Introduction

FCP1636

VVA No: 23914 16,90

FMSI No: D1108

AUDI Rear, SEAT Rear, SKODA Rear, VOLKSWAGEN Rear

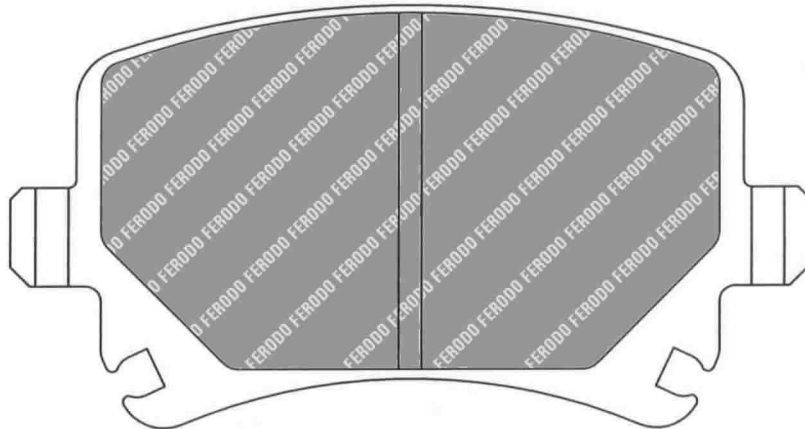
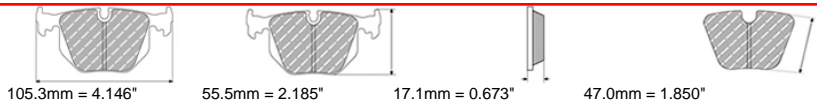

MATERIAL AVAILABILITY						
H	C	R	W	WB	Z	ZB
✓		✉				

CROSS REFERENCE	
ALCON	PNF0084X363.4
FMSI	D1108
HAWK	HB544 0,628
MINTEX	MDB2580
PAGID	8046
PAGID	T2454
VVA	23914 16,90

FCP1639

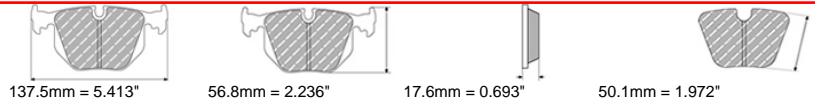

FMSI No: D929

SCION Front, SUBARU Front, TOYOTA Front

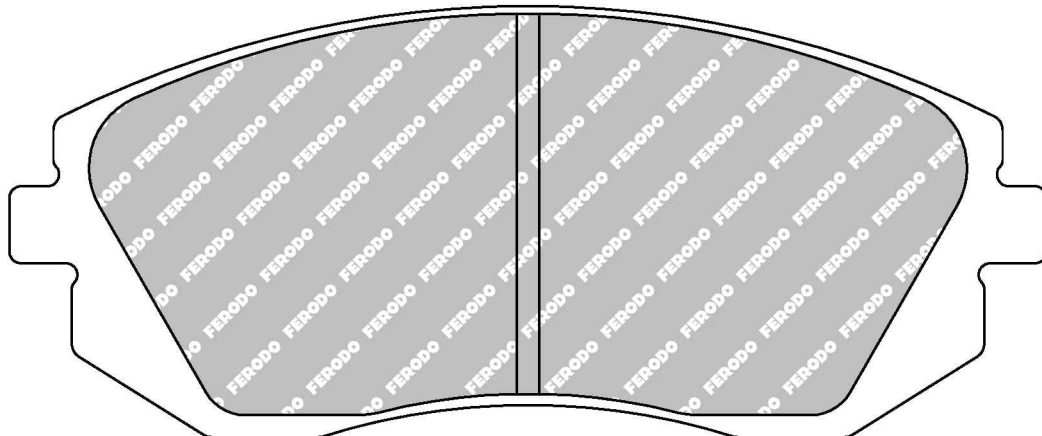

MATERIAL AVAILABILITY						
H	C	R	W	WB	Z	ZB
✓			✓		✓	

CROSS REFERENCE	
FMSI	D929
HAWK	HB432 0,661
MINTEX	MDB2274
PAGID	8174

FCP1640

WVA No: 23832 20,40



155.1mm = 6.106"
155.1mm = 6.106"



69.5mm = 2.736"
76.3mm = 3.004"



20.4mm = 0.803"
20.4mm = 0.803"

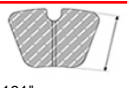

55.4mm = 2.181"
55.4mm = 2.181"

HOLDEN Front, OPEL Front, VAUXHALL Front

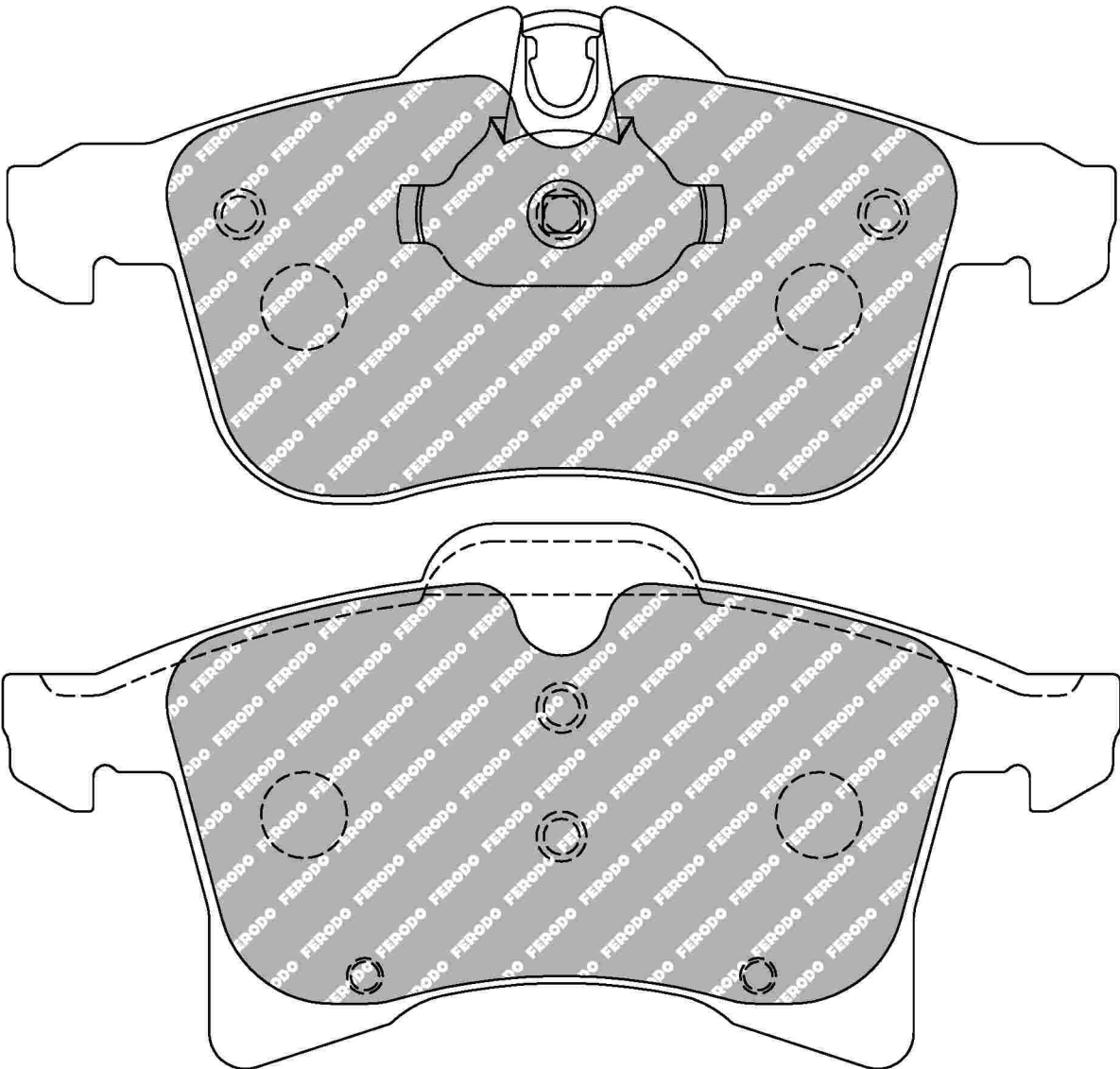

MATERIAL AVAILABILITY

H	C	R	W	WB	Z	ZB
✓			✉		✉	

CROSS REFERENCE

MINTEX	MDB2633
WVA	23832 20,40

✓ Available ⚠ Exhausting
 ✗ Out of Range ✉ Make to order
 ⓘ In Introduction

FERODO
RACING
Updated on 17th Aug 2018

3155

FCP1641

WVA No: 23587 20,30

FMSI No: D1107



156.5mm = 6.161"
155.2mm = 6.110"



71.4mm = 2.811"
66.0mm = 2.598"



19.4mm = 0.764"
19.4mm = 0.764"

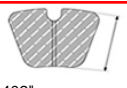

61.0mm = 2.402"
61.0mm = 2.402"

AUDI Front, CITROEN Front, PEUGEOT Front, PORSCHE Front, SEAT Front, SKODA Front, VOLKSWAGEN Front

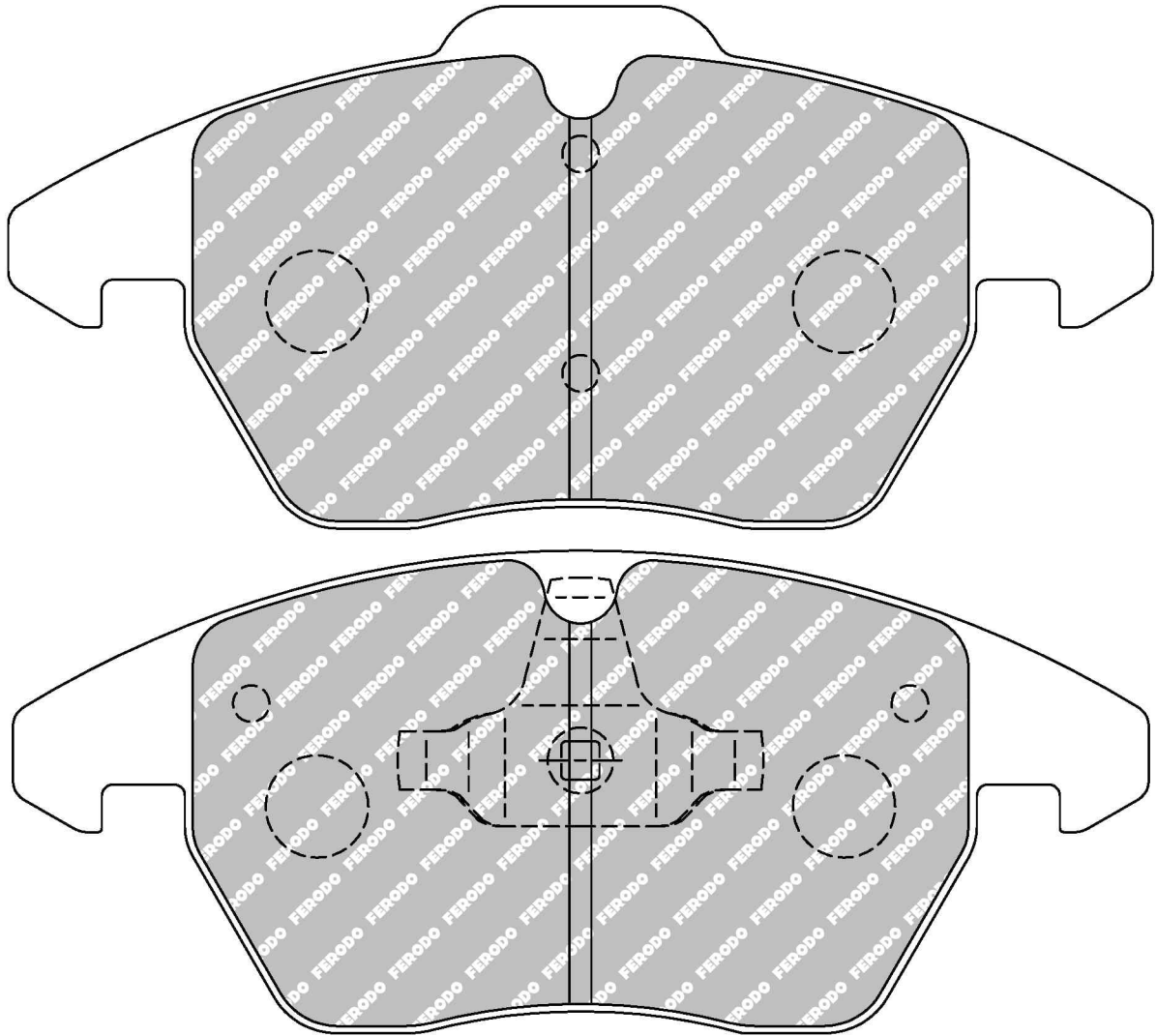

MATERIAL AVAILABILITY

H	C	R	W	WB	Z	ZB
✓		✉	✓		✓	

CROSS REFERENCE

FMSI	D1107
HAWK	HB543 0,76
MINTEX	MDB2604
OE VOLKSWAGEN	8X0698151
PAGID	8001
PAGID	T2444
WVA	23587 20,30

3156

FERODO

RACING
Updated on 17th Aug 2018

✓ Available ⚠ Exhausting
 ✗ Out of Range ✉ Make to order
 🔄 In Introduction

FCP1655

WVA No: 23326

FMSI No: D1018

AUDI Rear



116.2mm = 4.575"



59.0mm = 2.323"



17.5mm = 0.689"



47.0mm = 1.850"

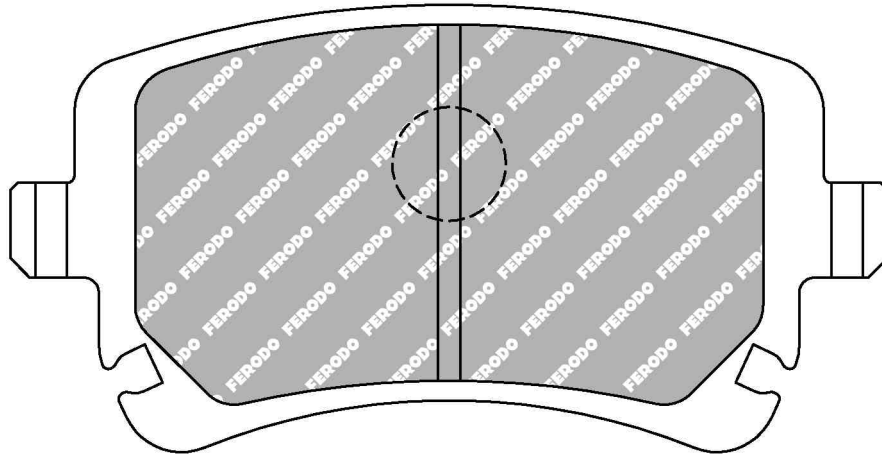

MATERIAL AVAILABILITY						
H	C	R	W	WB	Z	ZB
✓						

CROSS REFERENCE	
FMSI	D1018
MINTEX	MDB2544
MINTEX	MDB3086
PAGID	8039
WVA	23326

FCP1661

WVA No: 23745 - 23271 17,70

FMSI No: D847

MERCEDES Front

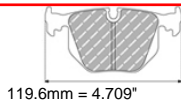

119.6mm = 4.709"

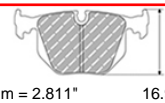

71.4mm = 2.811"



16.9mm = 0.665"

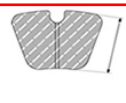

50.8mm = 2.000"

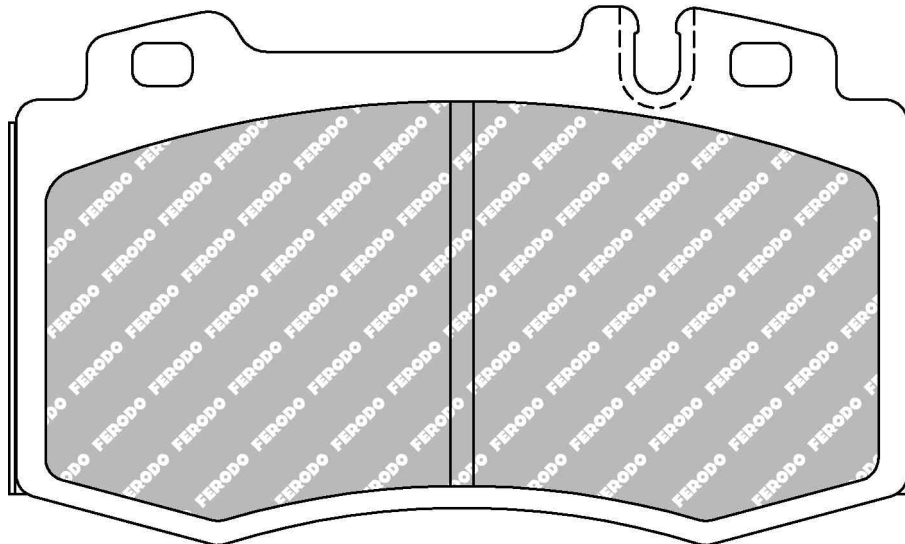

MATERIAL AVAILABILITY						
H	C	R	W	WB	Z	ZB
✓						

CROSS REFERENCE	
FMSI	D847
MINTEX	MDB2064
MINTEX	MDB2598
WVA	23745 - 23271 17,70

- ✓ Available
- ✗ Out of Range
- ⓘ In Introduction
- ⚠ Exhausting
- 📦 Make to order

FCP1664

WVA No: 23764 17,00



95.4mm = 3.756"



74.3mm = 2.925"



17.0mm = 0.669"



56.5mm = 2.224"

AUDI Front / Rear, LAMBORGHINI Front, VOLKSWAGEN Front

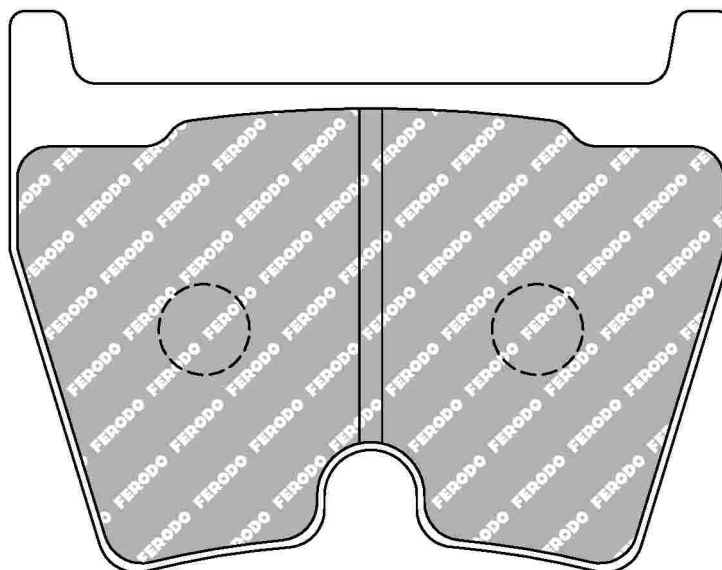

4 Pistons caliper

(1 set = 4 pads) - 2 sets per axle for the recommended applications

MATERIAL AVAILABILITY						
H	C	R	W	WB	Z	ZB
✓		✓	✓			

CROSS REFERENCE	
BREMBO	07.9312.44
BREMBO	07.9312.45
BREMBO	07.9312.46
BREMBO	07.9312.47
HAWK	HB609 0,572
MINTEX	MDB2601
PAGID	2931
WVA	23764 17,00

FCP1667

WVA No: 24764 17,00

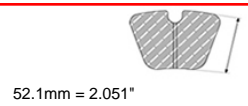
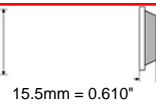
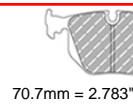
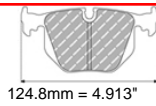

ABARTH Front, ALFA ROMEO Front, OPEL Front, RENAULT Front

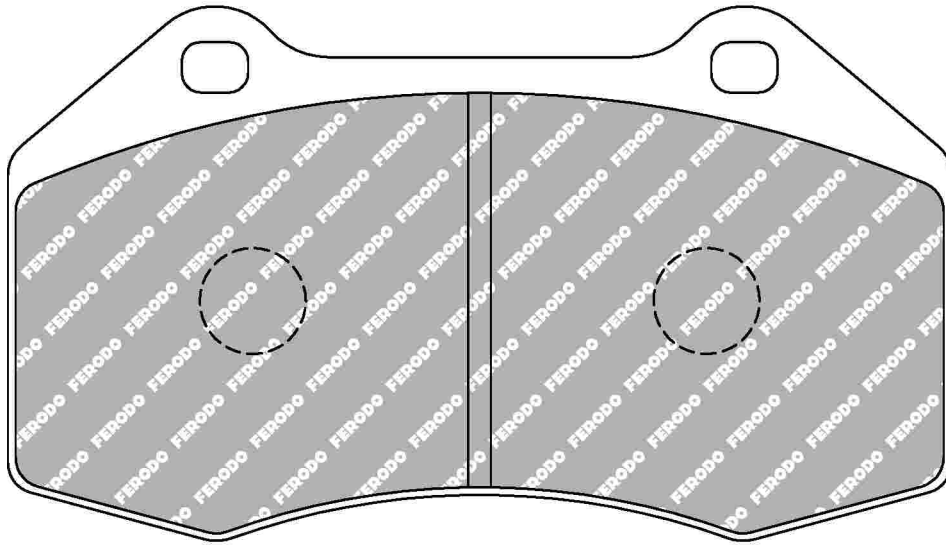

ALSO AVAILABLE		
SHAPE	TH. MM	NOTES
FCP4821	13.8	

MATERIAL AVAILABILITY						
H	C	R	W	WB	Z	ZB
✓		✓	✓		✓	✓

CROSS REFERENCE	
MINTEX	MDB2725
PAGID	8023
PFC	7871-07-16-44
WVA	24764 17,00

✓ Available ⚠ Exhausting
 ✗ Out of Range 📦 Make to order
 📌 In Introduction

FCP1672

WVA No: 23309 17,00

FMSI No: D919



139.8mm = 5.504"
139.8mm = 5.504"



67.8mm = 2.669"
66.9mm = 2.634"



16.1mm = 0.634"
16.1mm = 0.634"

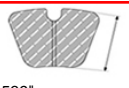

64.5mm = 2.539"
64.5mm = 2.539"

BMW Rear

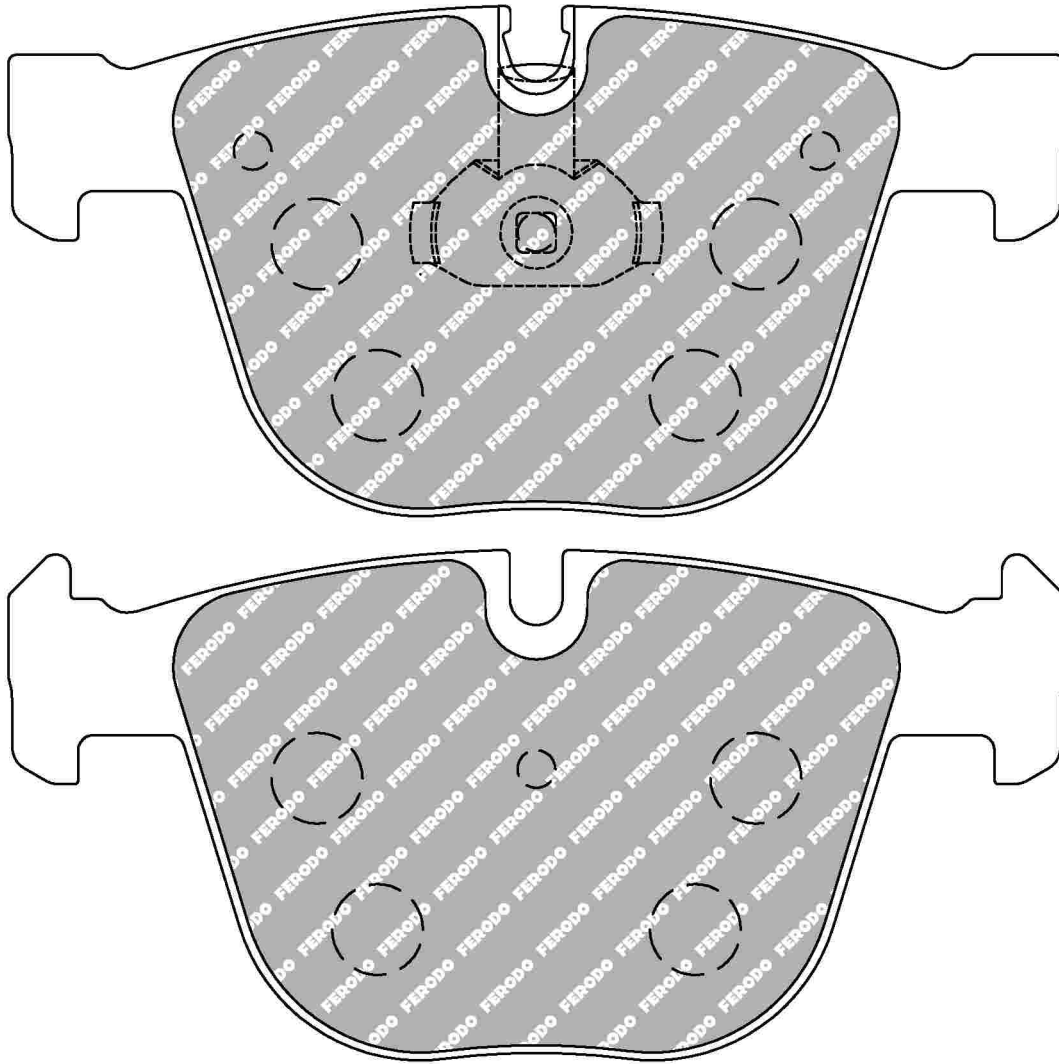

MATERIAL AVAILABILITY						
H	C	R	W	WB	Z	ZB
✓			✉		✓	

CROSS REFERENCE	
FMSI	D919
MINTEX	MDB2419
MINTEX	MDB2765
PAGID	8021
WVA	23309 17,00

FCP1676

WVA No: 23716 16,40

FMSI No: D940

HONDA Rear, MINI Rear



123.2mm = 4.850"



43.9mm = 1.728"



15.9mm = 0.626"

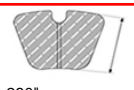

32.5mm = 1.280"

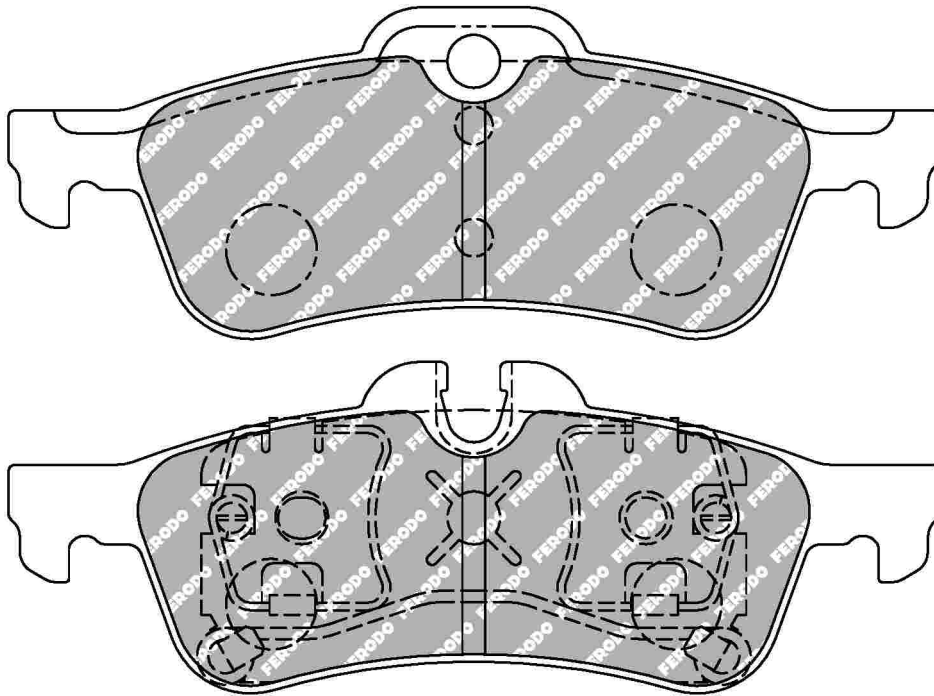

Replacing FCP1500

MATERIAL AVAILABILITY

H	C	R	W	WB	Z	ZB
✓						

CROSS REFERENCE

BREMBO	07.8301.21
FMSI	D940
HAWK	HB445 0,61
MINTEX	MDB2639
WVA	23716 16,40

✓ Available ⚠ Exhausting
 ✗ Out of Range 📦 Make to order
 📅 In Introduction

FCP1690



157.1mm = 6.185"



58.5mm = 2.303"



16.8mm = 0.661"



48.1mm = 1.894"

FMSI No: D888

INFINITI Front, NISSAN Front

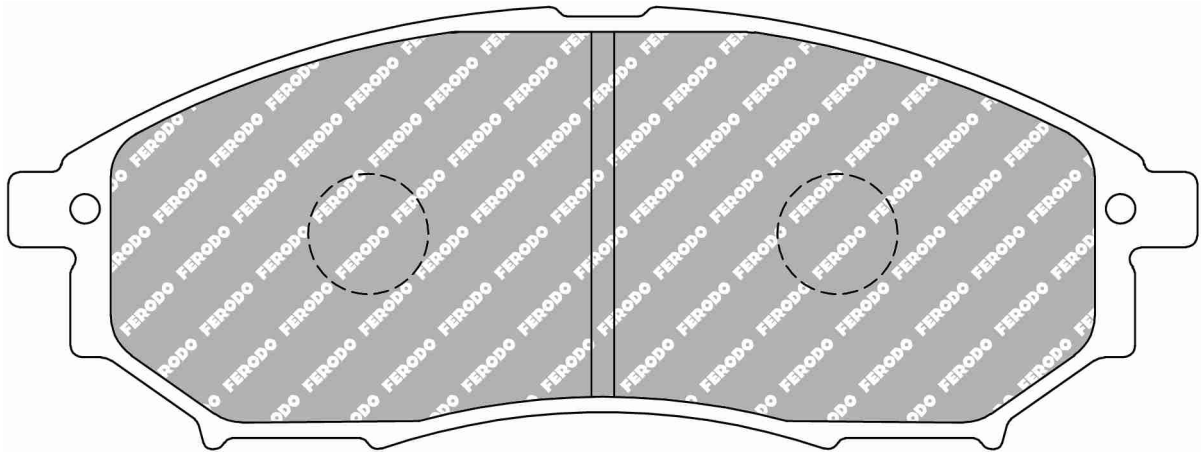

MATERIAL AVAILABILITY						
H	C	R	W	WB	Z	ZB
✓						

CROSS REFERENCE	
FMSI	D888
HAWK	HB387 0,547
MINTEX	MDB2247

FCP1693

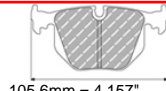

105.6mm = 4.157"



38.2mm = 1.504"



14.1mm = 0.555"



29.9mm = 1.177"

WVA No: 23871 14,00

FMSI No: D905

INFINITI Rear, NISSAN Rear

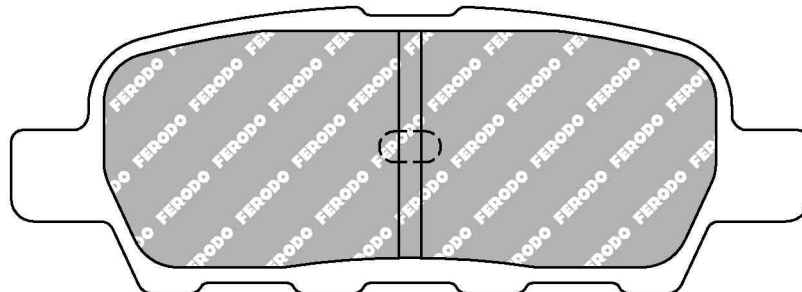

MATERIAL AVAILABILITY						
H	C	R	W	WB	Z	ZB
✓						

CROSS REFERENCE	
FMSI	D905
HAWK	HB370 0,559
MINTEX	MDB2261
WVA	23871 14,00

FCP1698

WVA No: 24024

FMSI No: D976



134.45mm = 5.293"



77.5mm = 3.051"



17mm = 0.669"

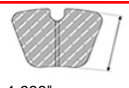

50.5mm = 1.988"

LEXUS Front, MITSUBISHI Front, TOYOTA Front

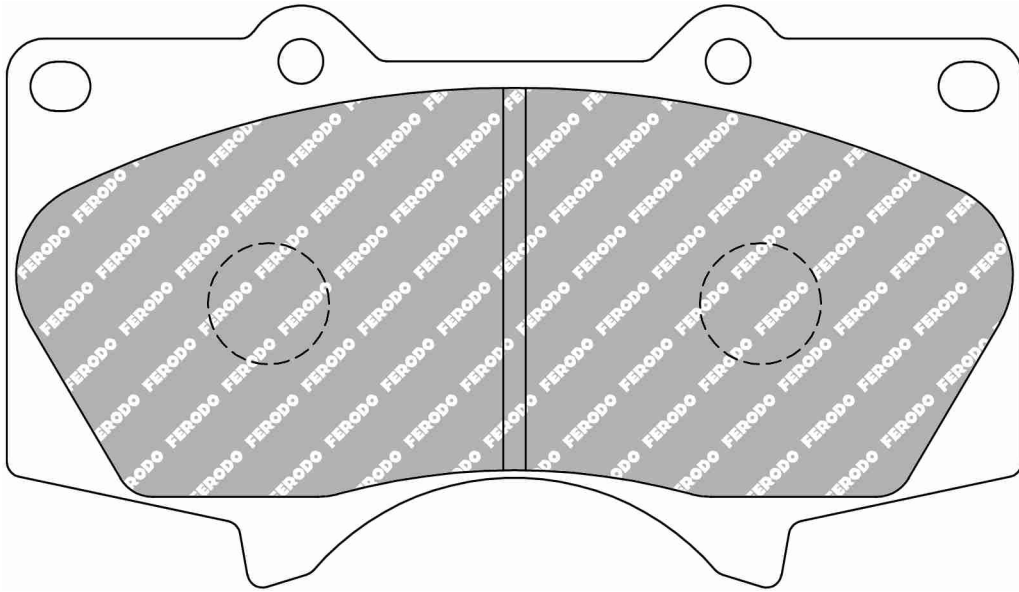

MATERIAL AVAILABILITY

H	C	R	W	WB	Z	ZB
✓						

CROSS REFERENCE

BREMBO	P83 066
EBC	DP41657
FMSI	D976
WVA	24024

✓ Available ⚠ Exhausting
 ✗ Out of Range 📦 Make to order
 ⓘ In Introduction

FCP1706

WVA No: 23912 18,50 - 23801 18,50

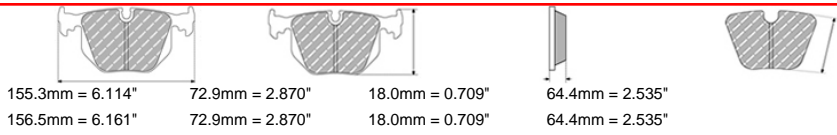

FORD Front, MAZDA Front, SAAB Front, VOLVO Front

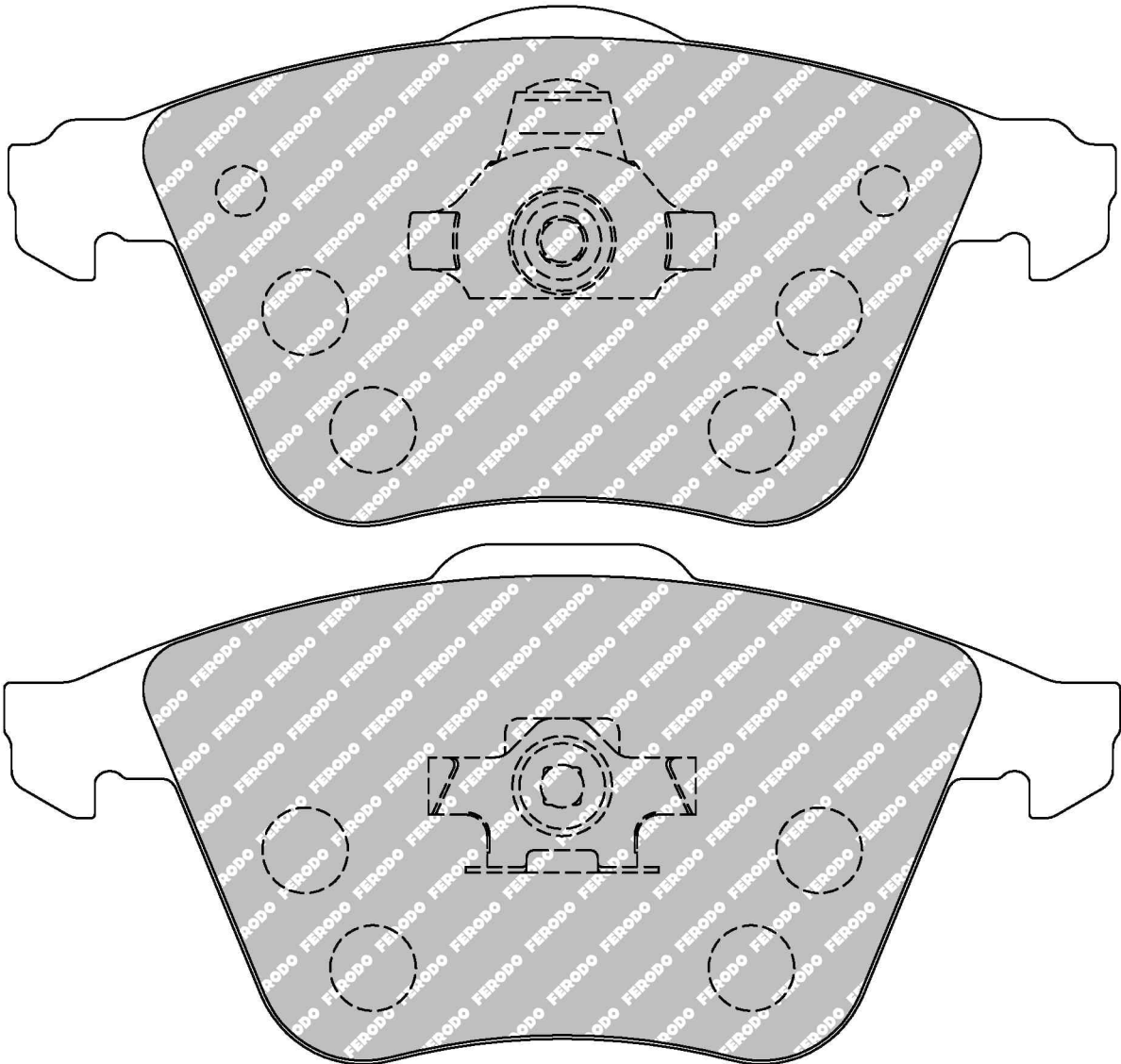

MATERIAL AVAILABILITY						
H	C	R	W	WB	Z	ZB
✓			✉			

CROSS REFERENCE	
MINTEX	MDB2749
WVA	23912 18,50 - 23801 18,50

FCP1717

WVA No: 20676 20,10



156.5mm = 6.161"
156.5mm = 6.161"



74.4mm = 2.929"
74.4mm = 2.929"



20.1mm = 0.791"
20.1mm = 0.791"

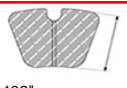

61.0mm = 2.402"
61.0mm = 2.402"

AUDI Front, SEAT Front, SKODA Front, VOLKSWAGEN Front

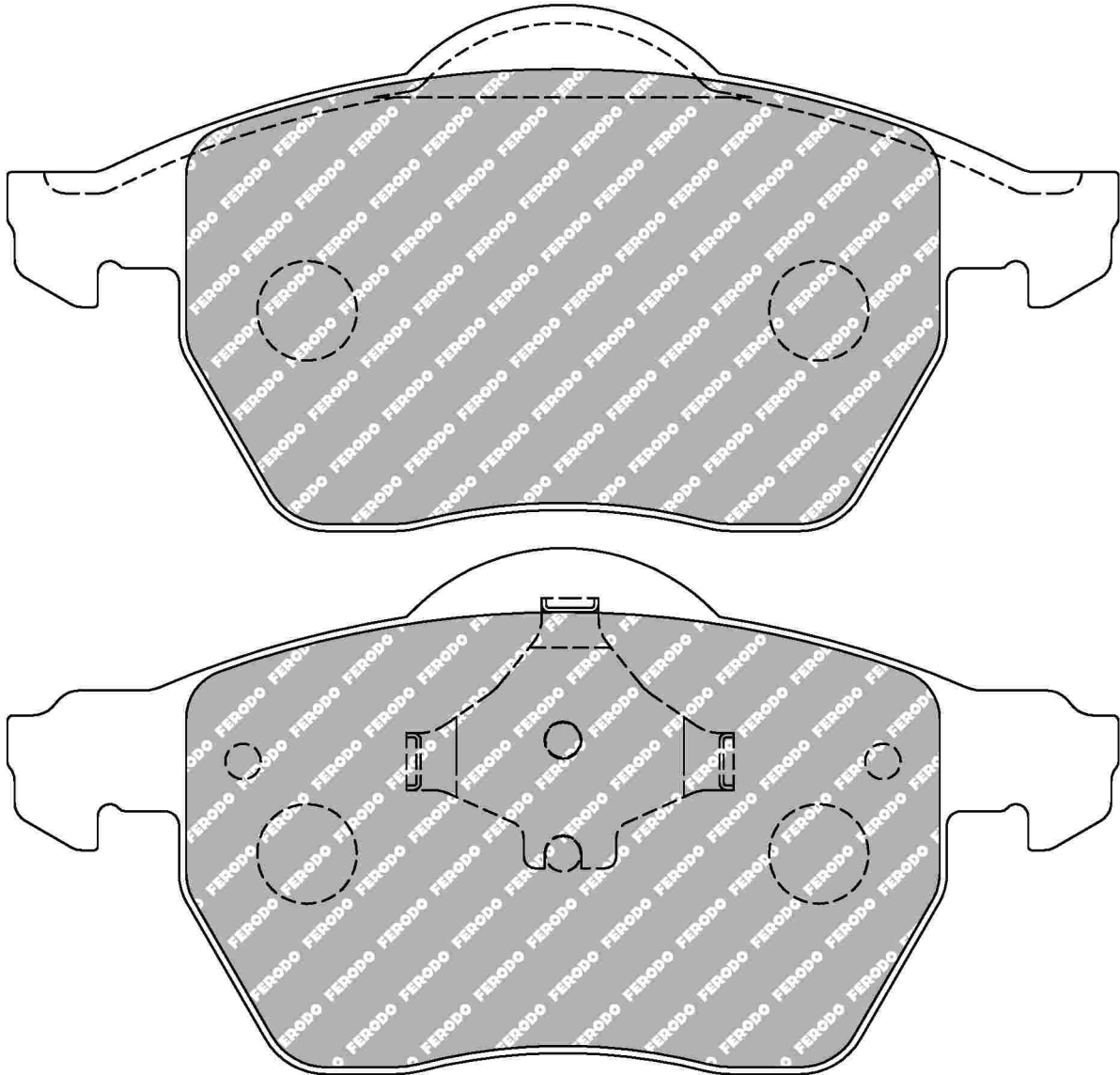

MATERIAL AVAILABILITY						
H	C	R	W	WB	Z	ZB
✓						

CROSS REFERENCE	
MINTEX	MDB2231
WVA	20676 20,10

- ✓ Available
- ✗ Out of Range
- ⓘ In Introduction
- ⚠ Exhausting
- 📦 Make to order

FCP1725

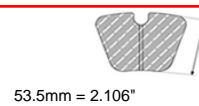
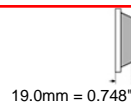
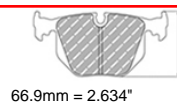
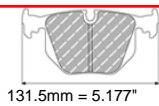

PEUGEOT Front

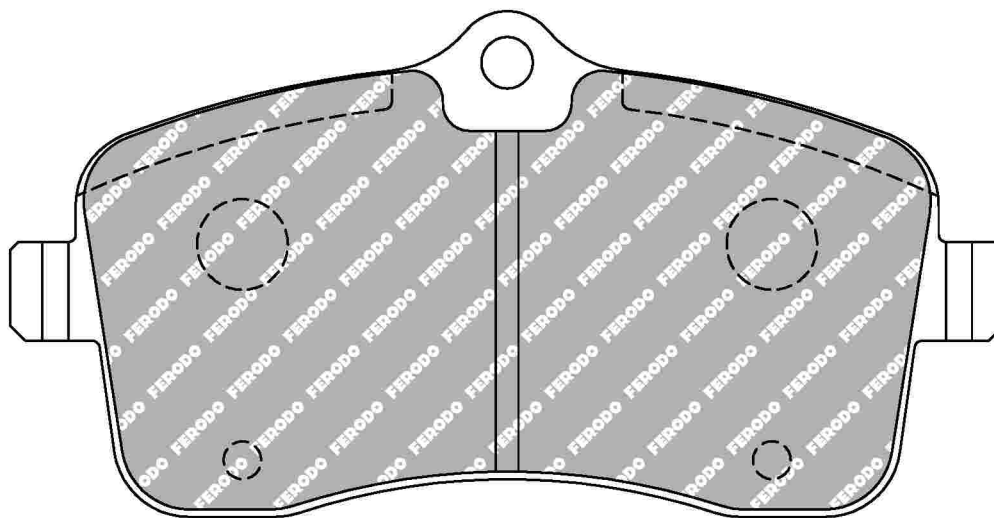

MATERIAL AVAILABILITY						
H	C	R	W	WB	Z	ZB

CROSS REFERENCE	
MINTEX	MDB2701

FCP1747

WVA No: 23915 17,60 - 23916 17,60

FMSI No: D1308

BMW Front, MINI Front



131.4mm = 5.173"
131.4mm = 5.173"



56.3mm = 2.217"
65.0mm = 2.559"



17.0mm = 0.669"
17.0mm = 0.669"



45.6mm = 1.795"
45.6mm = 1.795"

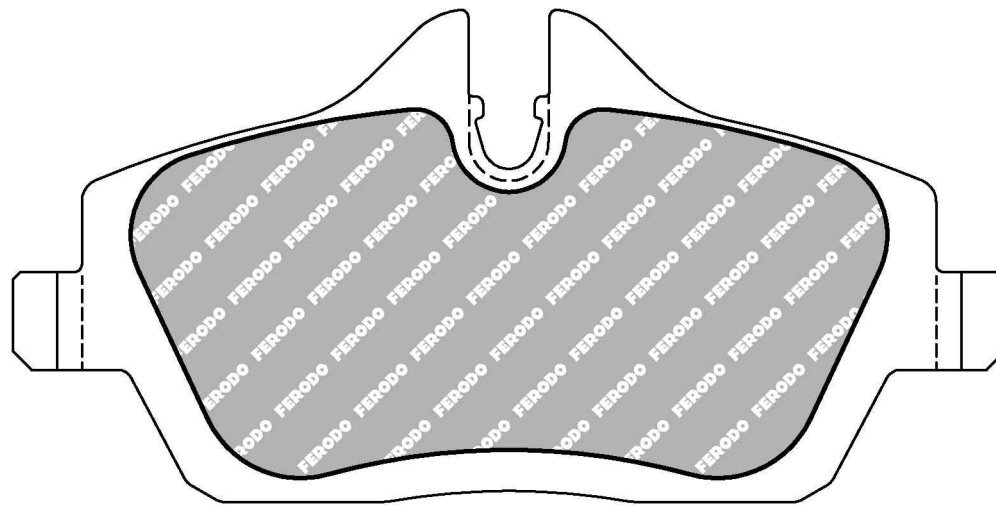
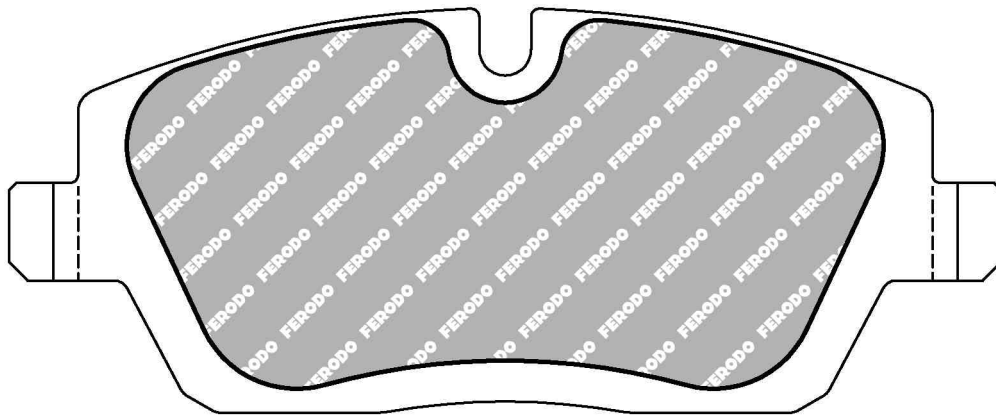

MATERIAL AVAILABILITY

H	C	R	W	WB	Z	ZB
✓						

CROSS REFERENCE

FMSI	D1308
HAWK	HB570 .677
MINTEX	MDB2682
WVA	23915 17,60 - 23916 17,60

✓ Available ⚠ Exhausting
 ✗ Out of Range 📦 Make to order
 📌 In Introduction

FCP1751

WVA No: 23935 17,60



149.4mm = 5.882"
150.3mm = 5.917"



57.5mm = 2.264"
57.5mm = 2.264"



17.6mm = 0.693"
17.6mm = 0.693"

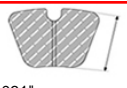

51.6mm = 2.031"
51.6mm = 2.031"

BMW Front

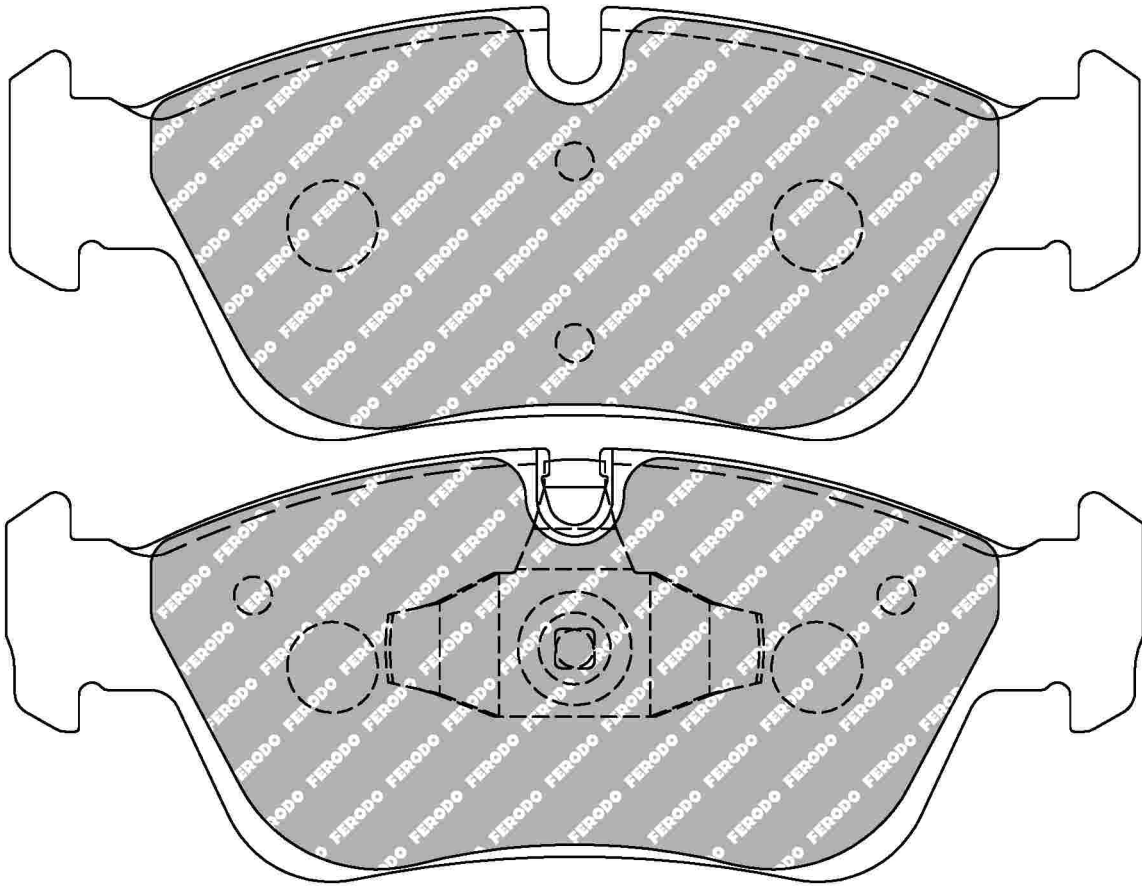

MATERIAL AVAILABILITY						
H	C	R	W	WB	Z	ZB

CROSS REFERENCE	
MINTEX	MDB2684
WVA	23935 17,60

FCP1765

WVA No: 23912 20,20 - 23801 20,2

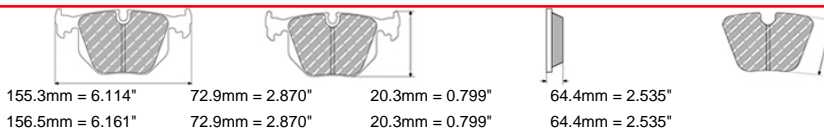

AUDI Front, SEAT Front, SKODA Front, VOLKSWAGEN Front

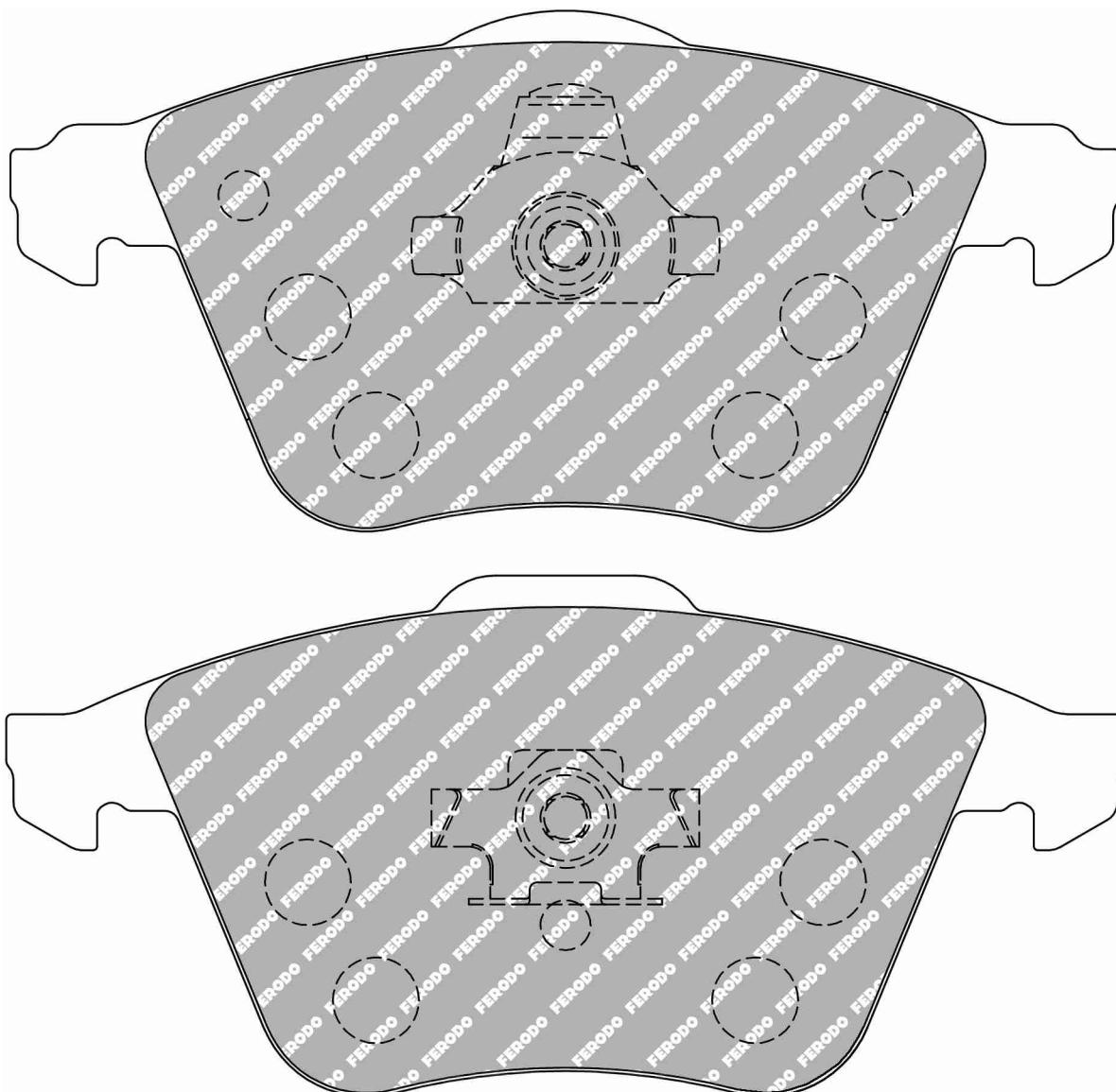

MATERIAL AVAILABILITY						
H	C	R	W	WB	Z	ZB
✓			✉		✓	

CROSS REFERENCE	
MINTEX	MDB2677
WVA	23912 20,20 - 23801 20,2

- ✓ Available
- ✗ Out of Range
- ✉ In Introduction
- ⚠ Exhausting
- ✉ Make to order

FCP1773

WVA No: 23794 19,80



154.9mm = 6.098"
155.3mm = 6.114"



63.5mm = 2.500"
63.5mm = 2.500"



19.2mm = 0.756"
19.2mm = 0.756"

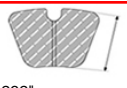

56.7mm = 2.232"
56.7mm = 2.232"

BMW Front

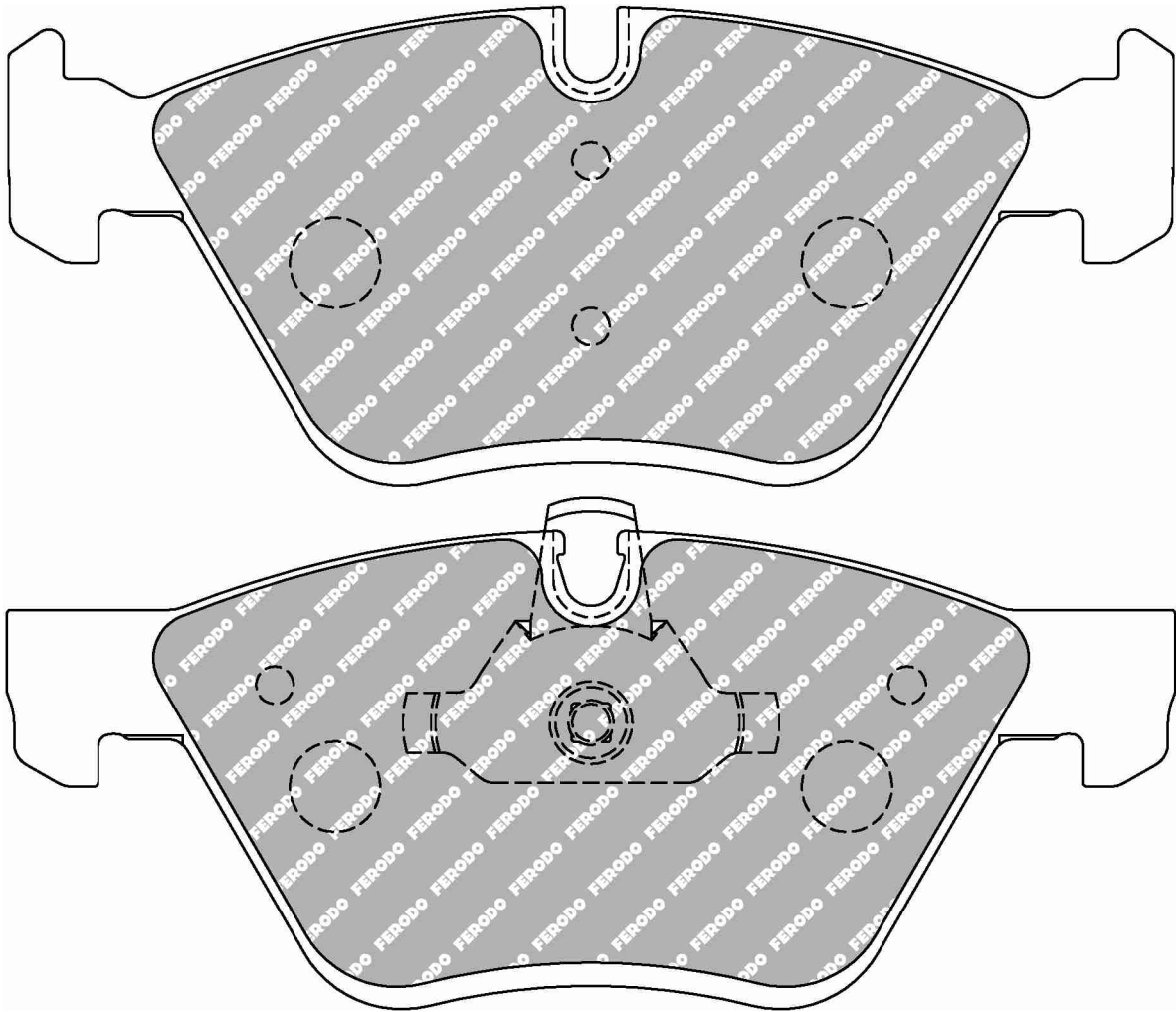

MATERIAL AVAILABILITY						
H	C	R	W	WB	Z	ZB
✓						

CROSS REFERENCE	
MINTEX	MDB2692
MINTEX	MDB3007
PFC	0394
WVA	23794 19,80

FCP1783

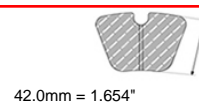
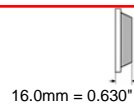
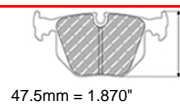
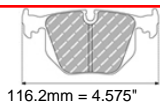

HYUNDAI Front, KIA Front

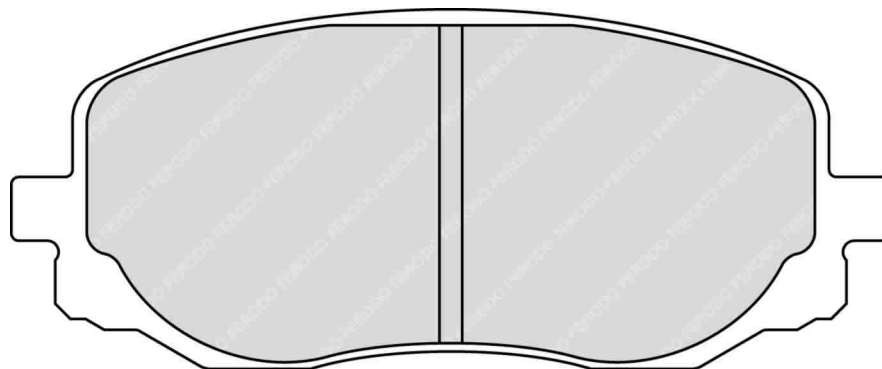

MATERIAL AVAILABILITY						
H	C	R	W	WB	Z	ZB

CROSS REFERENCE	
MINTEX	MDB2720

- Available
- Out of Range
- In Introduction
- Exhausting
- Make to order

FCP1786

WVA No: 24956 15,50

FMSI No: D969

INFINITI Front, NISSAN Front



135.7mm = 5.343"



69.9mm = 2.752"



15.5mm = 0.610"

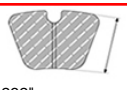

56.7mm = 2.232"

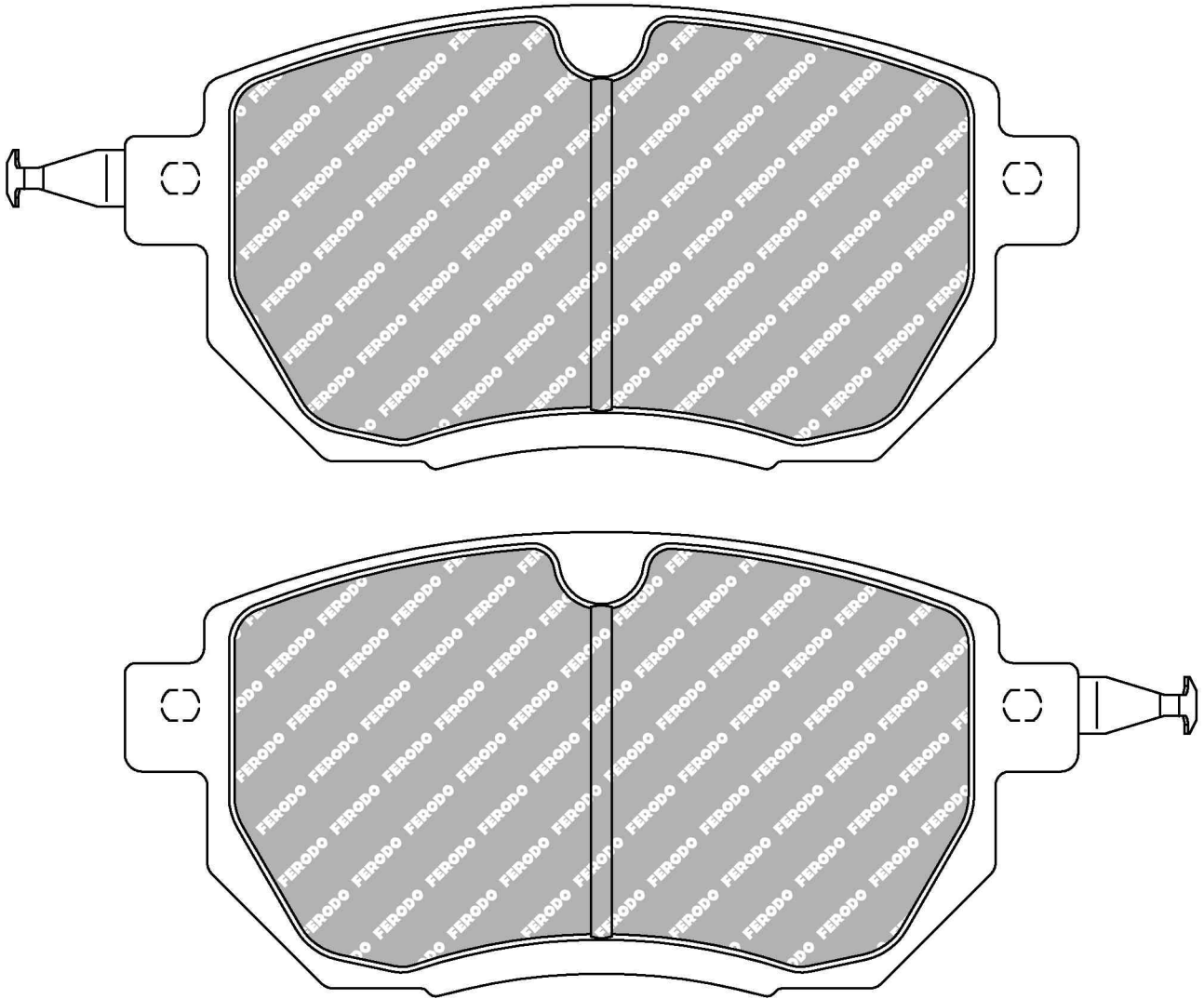

MATERIAL AVAILABILITY

H	C	R	W	WB	Z	ZB
✓						

CROSS REFERENCE

FMSI	D969
HAWK	HB448 0,61
MINTEX	MDB2387
WVA	24956 15,50

FCP1790

WVA No: 23959 17,40



122.8mm = 4.835"



47.3mm = 1.862"



17.4mm = 0.685"

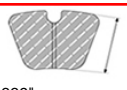

34.0mm = 1.339"

CITROEN Front, PEUGEOT Front, TOYOTA Front

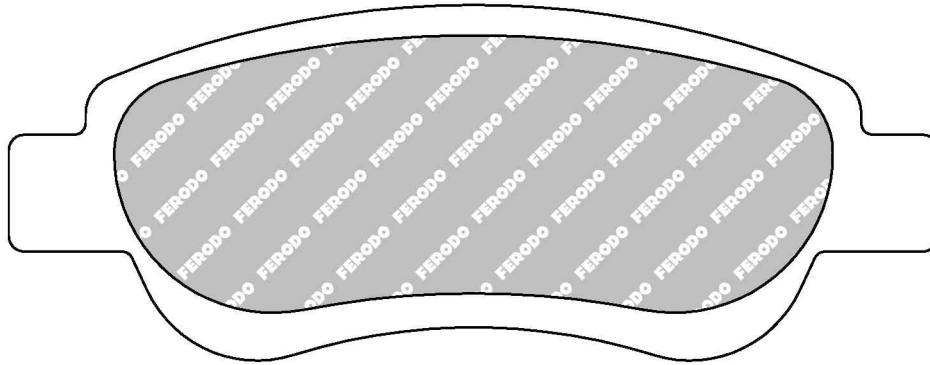

MATERIAL AVAILABILITY						
H	C	R	W	WB	Z	ZB
✓		✉				

CROSS REFERENCE	
MINTEX	MDB2743
WVA	23959 17,40

FCP1795

WVA No: 23760 17,50

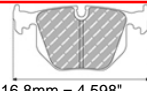

116.8mm = 4.598"



50.3mm = 1.980"



17.5mm = 0.689"

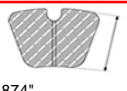

47.6mm = 1.874"

ALFA ROMEO Rear

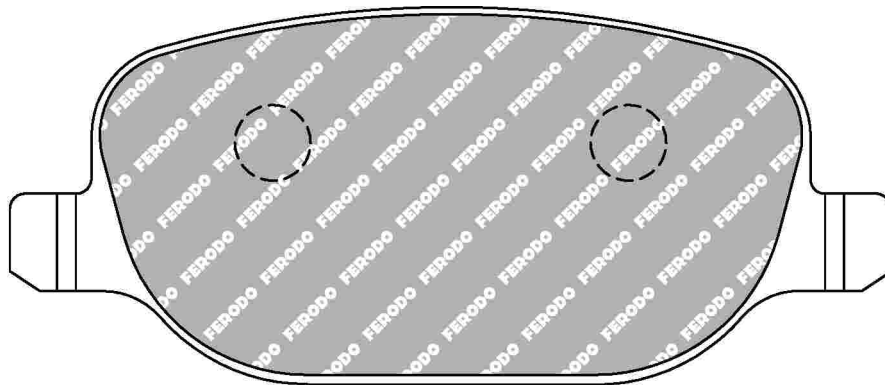

MATERIAL AVAILABILITY						
H	C	R	W	WB	Z	ZB
✓			✉		✉	

CROSS REFERENCE	
MINTEX	MDB2624
MINTEX	MDB3125
WVA	23760 17,50

FCP1805

WVA No: 24339 19,90



156.5mm = 6.161"
155.4mm = 6.118"



71.6mm = 2.819"
69.2mm = 2.724"



19.3mm = 0.760"
18.5mm = 0.728"

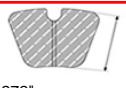

57.7mm = 2.272"
57.7mm = 2.272"

ALFA ROMEO Front

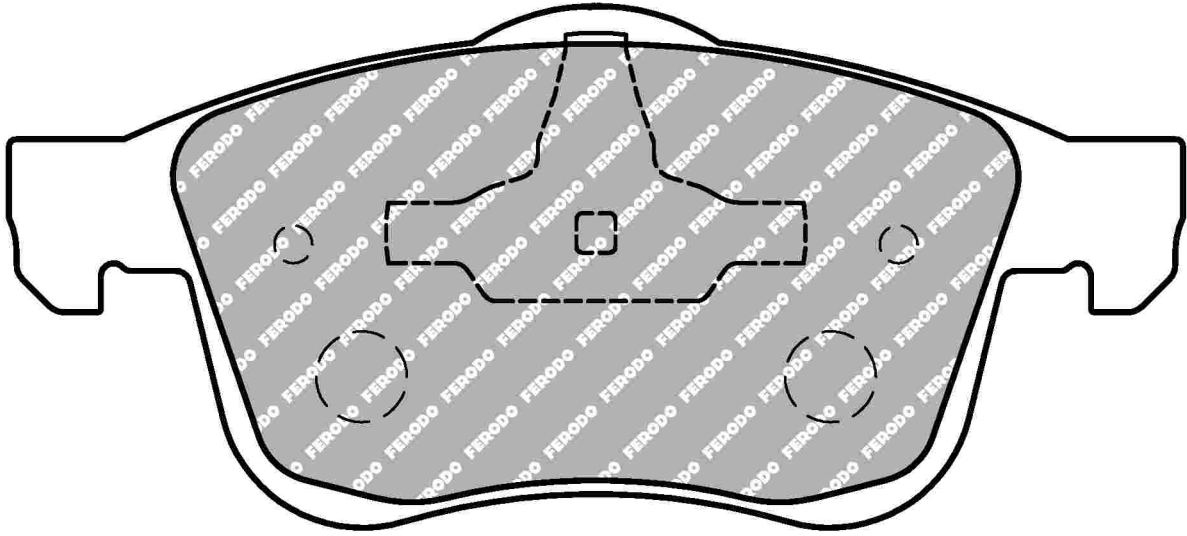
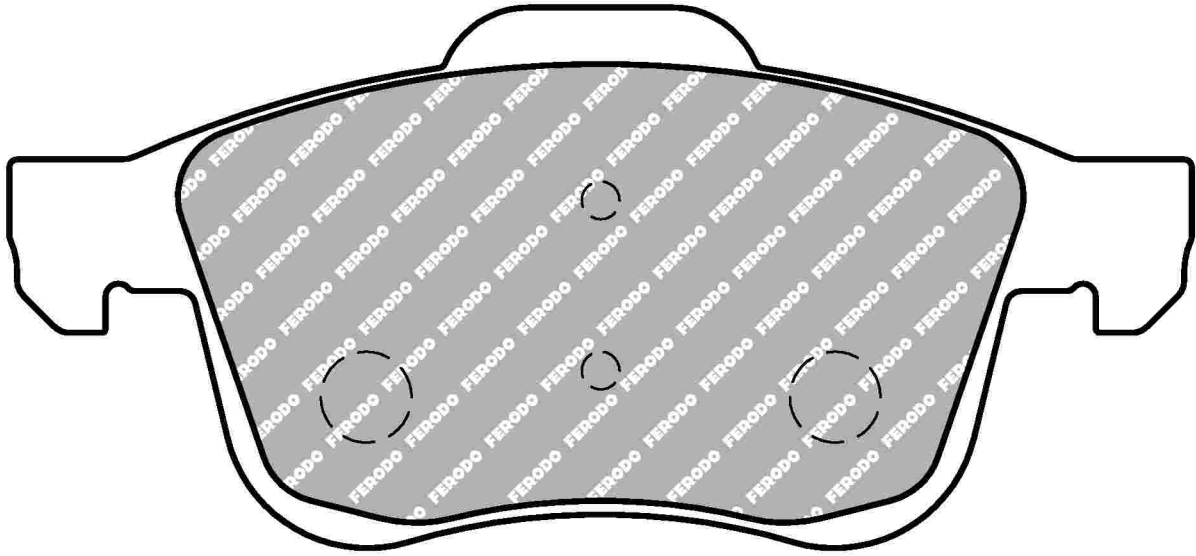

MATERIAL AVAILABILITY						
H	C	R	W	WB	Z	ZB
✓						

CROSS REFERENCE	
MINTEX	MDB2790
WVA	24339 19,90

FCP1806

WVA No: 23623 17,20

FMSI No: D1309



95.5mm = 3.760"
95.5mm = 3.760"



45.0mm = 1.772"
51.5mm = 2.028"



16.6mm = 0.654"
16.6mm = 0.654"

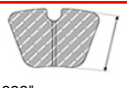

43.0mm = 1.693"
43.0mm = 1.693"

BMW Rear, MINI Rear

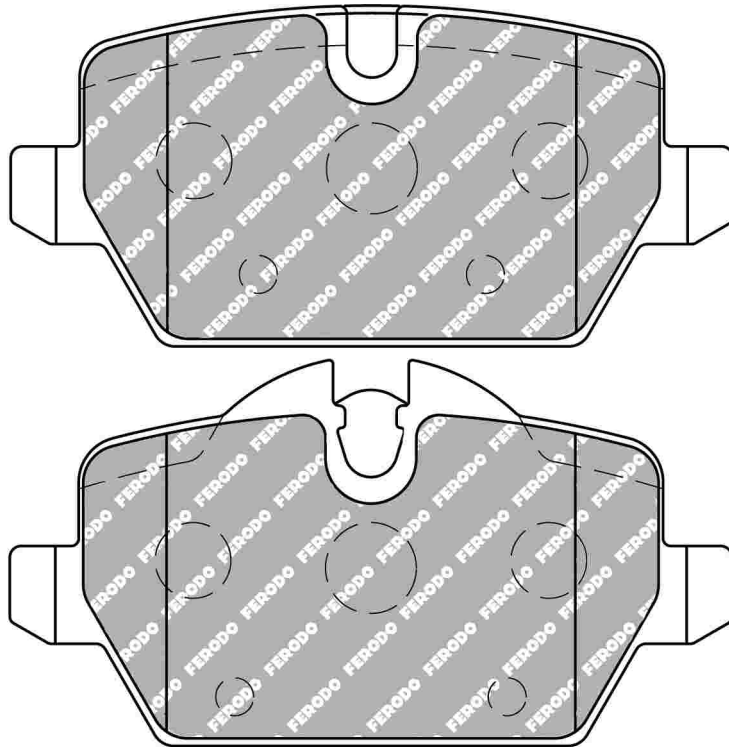

MATERIAL AVAILABILITY

H	C	R	W	WB	Z	ZB
✓						

CROSS REFERENCE

FMSI	D1309
HAWK	HB574 .666
MINTEX	MDB2681
MINTEX	MDB3131
WVA	23623 17,20

✓ Available ⚠ Exhausting
 ✗ Out of Range 📦 Make to order
 📌 In Introduction

FERODO
RACING
 Updated on 17th Aug 2018

3175

FCP1807

WVA No: 23926 17,00



123.2mm = 4.850"
123.2mm = 4.850"



48.3mm = 1.902"
44.0mm = 1.732"



16.4mm = 0.646"
16.4mm = 0.646"

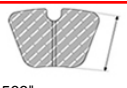

39.7mm = 1.563"
39.7mm = 1.563"

BMW Rear

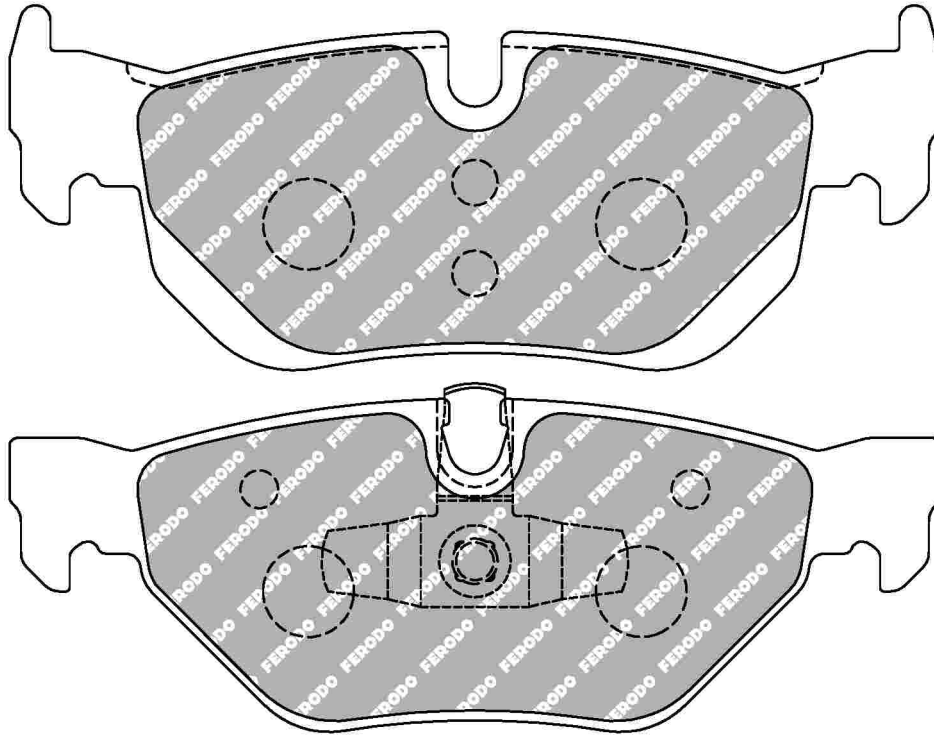

MATERIAL AVAILABILITY

H	C	R	W	WB	Z	ZB
✓						

CROSS REFERENCE

MINTEX	MDB2683
PFC	0396
WVA	23926 17,00

3176

FERODO

RACING

Updated on 17th Aug 2018

✓ Available ⚠ Exhausting
 ✗ Out of Range 📦 Make to order
 🔄 In Introduction

FCP1808

WVA No: 23550 17,00

FMSI No: D1170



123.2mm = 4.850"
123.2mm = 4.850"



59.0mm = 2.323"
57.9mm = 2.280"



16.4mm = 0.646"
16.4mm = 0.646"

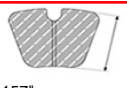

54.8mm = 2.157"
54.8mm = 2.157"

BMW Rear

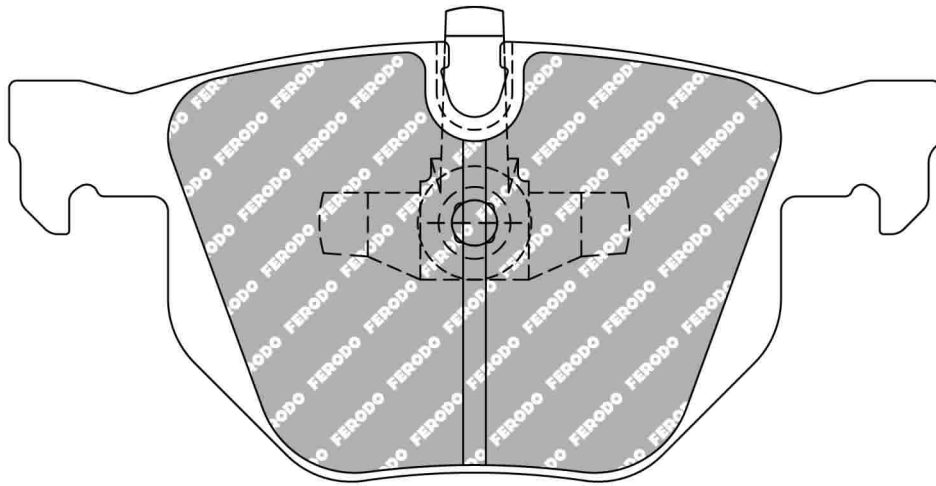
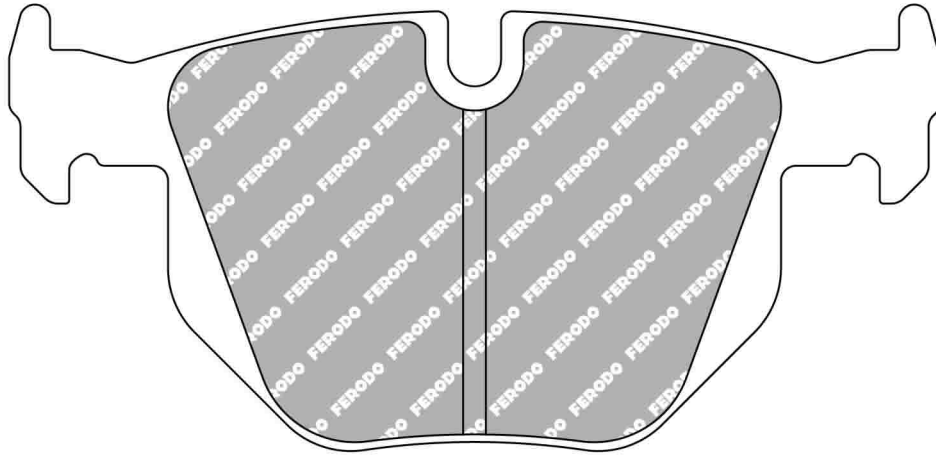

MATERIAL AVAILABILITY						
H	C	R	W	WB	Z	ZB
✓						

CROSS REFERENCE	
EBC	DP21588
FMSI	D1170
HAWK	HB624x.642
MINTEX	MDB2717
PAGID	8051
WVA	23550 17,00

✓ Available ⚠ Exhausting
 ✗ Out of Range 📦 Make to order
 ⓘ In Introduction

FCP1858

WVA No: 24349 17,20



102.0mm = 4.016"



47.0mm = 1.850"



17.3mm = 0.681"

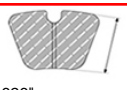

41.3mm = 1.626"

ABARTH Rear, FIAT Rear, OPEL Rear, VAUXHALL Rear

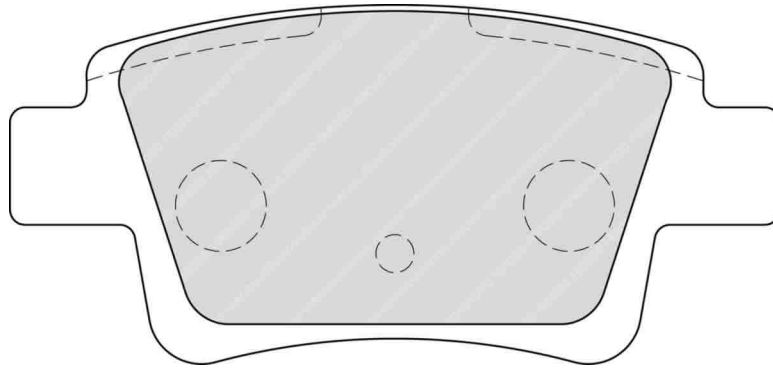

MATERIAL AVAILABILITY						
H	C	R	W	WB	Z	ZB
✓						

CROSS REFERENCE	
MINTEX	MDB2779
PAGID	4940
WVA	24349 17,20

FCP1859



131.7mm = 5.185"



55.8mm = 2.197"



16.5mm = 0.650"



50.5mm = 1.988"

HONDA Front

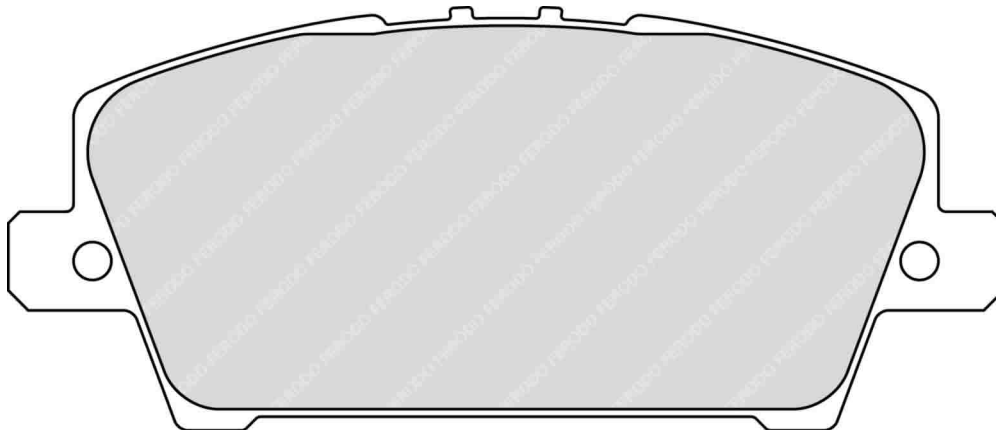

MATERIAL AVAILABILITY						
H	C	R	W	WB	Z	ZB
✓						

CROSS REFERENCE	
MINTEX	MDB2791

FCP1862

WVA No: 24086 15,50



95.8mm = 3.772"



46.3mm = 1.823"



14.5mm = 0.571"

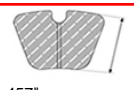

37.0mm = 1.457"

HONDA Rear

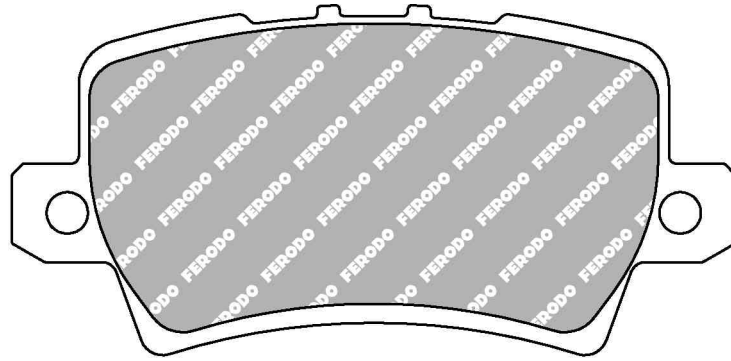

MATERIAL AVAILABILITY						
H	C	R	W	WB	Z	ZB
✓						

CROSS REFERENCE	
MINTEX	MDB2770
WVA	24086 15,50

FCP1894

WVA No: 24298



99.6mm = 3.921"



44.7mm = 1.760"



14.5mm = 0.571"



39.8mm = 1.567"

ABARTH Rear, MAZDA Rear

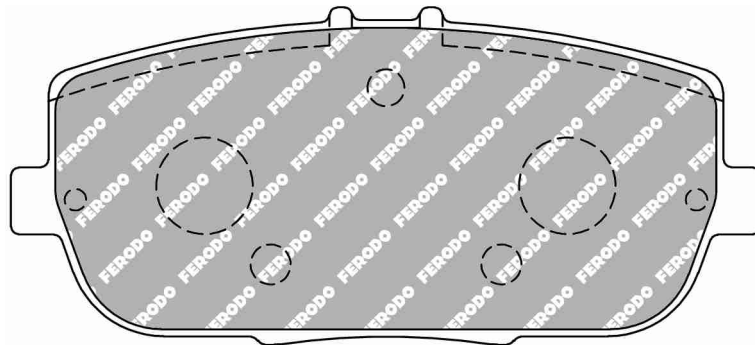

MATERIAL AVAILABILITY						
H	C	R	W	WB	Z	ZB
✓						

CROSS REFERENCE	
PAGID	8077
WVA	24298

FCP1917



95.3mm = 3.752"



43.2mm = 1.701"



15.1mm = 0.594"



41.3mm = 1.626"

FORD Rear, VOLVO Rear

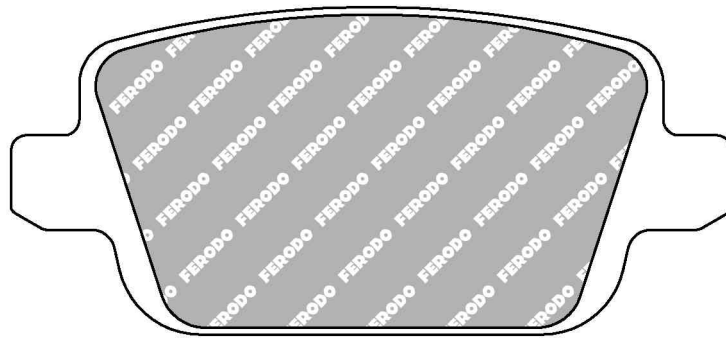

MATERIAL AVAILABILITY

H	C	R	W	WB	Z	ZB
✓						

CROSS REFERENCE

MINTEX	MDB2887
--------	---------

FCP1931

WVA No: 24137 16,30



123.1mm = 4.846"
123.1mm = 4.846"



51.9mm = 2.043"
51.9mm = 2.043"



16.3mm = 0.642"
16.3mm = 0.642"

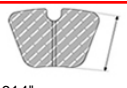

41.0mm = 1.614"
41.0mm = 1.614"

CADILLAC Rear, FORD Rear, JAGUAR Rear, MAZDA Rear, PONTIAC Rear, RENAULT Rear, SAAB Rear, VOLVO Rear

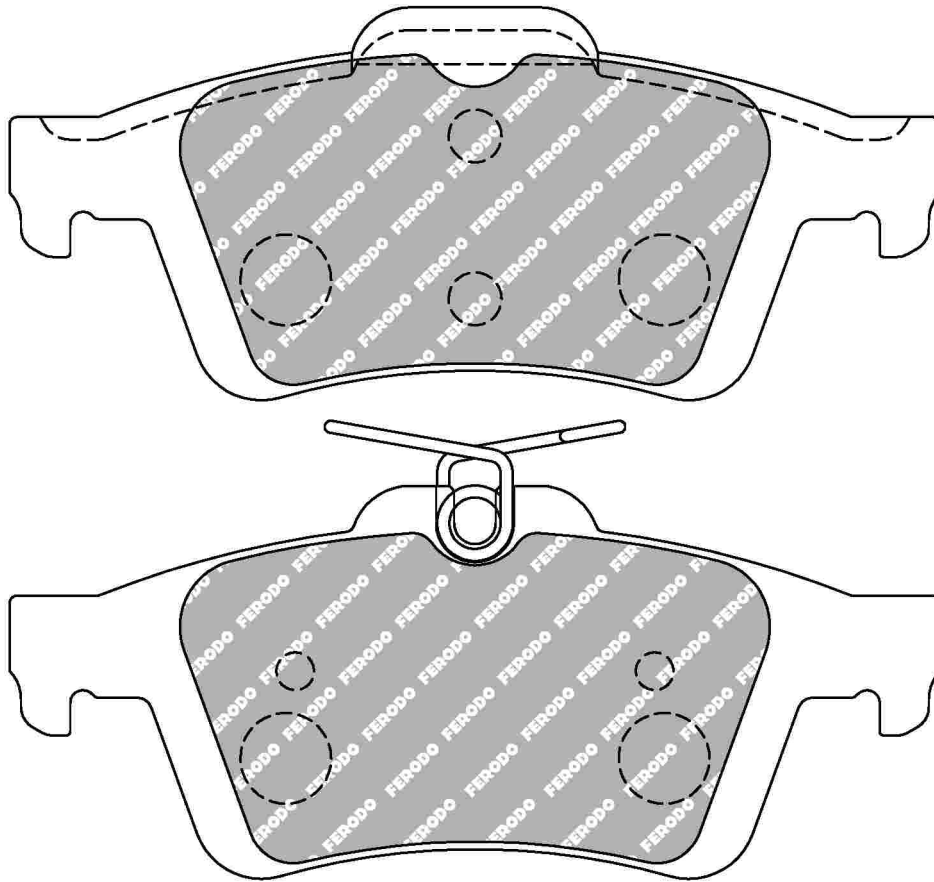

MATERIAL AVAILABILITY						
H	C	R	W	WB	Z	ZB
✓			📧			

CROSS REFERENCE	
MINTEX	MDB2686
MINTEX	MDB3150
OE FORD	1809458
WVA	24137 16,30

✓ Available ⚠ Exhausting
 ✗ Out of Range 📧 Make to order
 📌 In Introduction

FCP1947

WVA No: 24271 14,60

FMSI No: D1114

SUBARU Rear



110.5mm = 4.350"



38.2mm = 1.504"



14.6mm = 0.575"

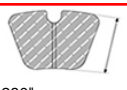

32.5mm = 1.280"

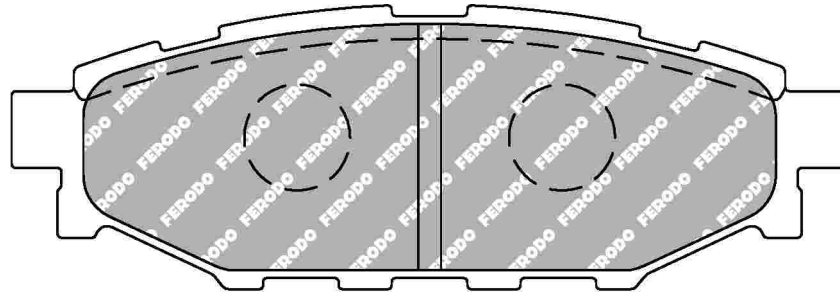

MATERIAL AVAILABILITY						
H	C	R	W	WB	Z	ZB
✓						

CROSS REFERENCE	
FMSI	D1114
HAWK	HB557
MINTEX	MDB2732
WVA	24271 14,60

FCP1954



150.4mm = 5.921"



56.9mm = 2.240"



19.0mm = 0.748"



50.5mm = 1.988"

CHRYSLER Front

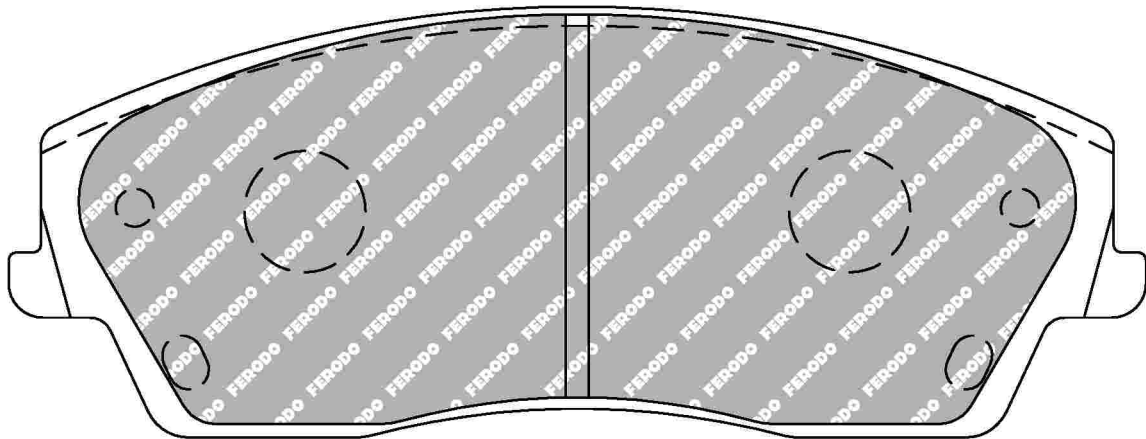

MATERIAL AVAILABILITY						
H	C	R	W	WB	Z	ZB
✉						

CROSS REFERENCE	
MINTEX	MDB2697

FCP1975

WVA No: 24289 17,10 - 24290 17,10

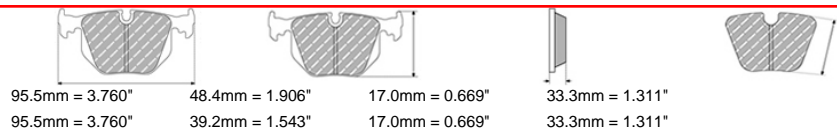

MINI Rear

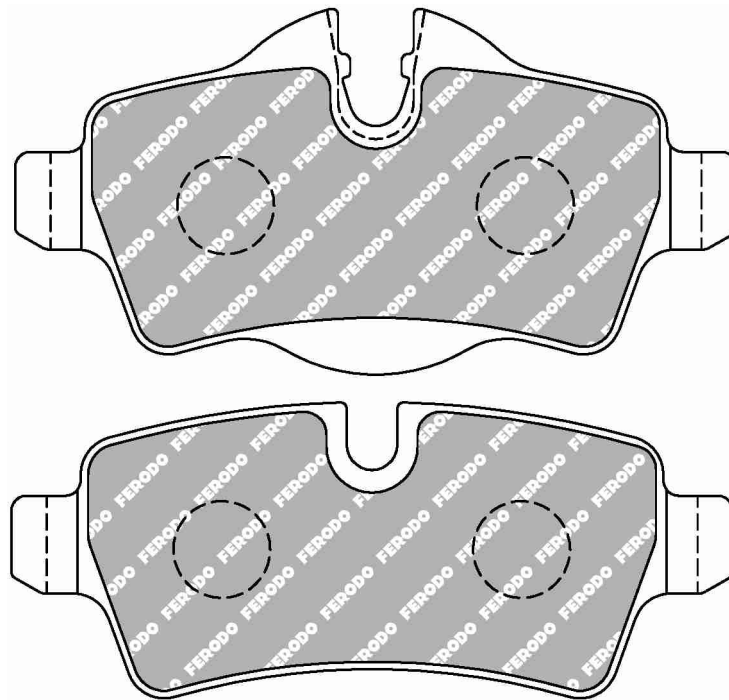

MATERIAL AVAILABILITY						
H	C	R	W	WB	Z	ZB
✓			✉			

CROSS REFERENCE	
MINTEX	MDB2930
WVA	24289 17,10 - 24290 17,10

- ✓ Available
- ✗ Out of Range
- ✉ In Introduction
- ⚠ Exhausting
- ✉ Make to order

FCP1984

WVA No: 24222 17,90

FMSI No: D1078

SUBARU Front



157.2mm = 6.189"



63.5mm = 2.500"



17.9mm = 0.705"

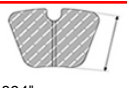

48.1mm = 1.894"

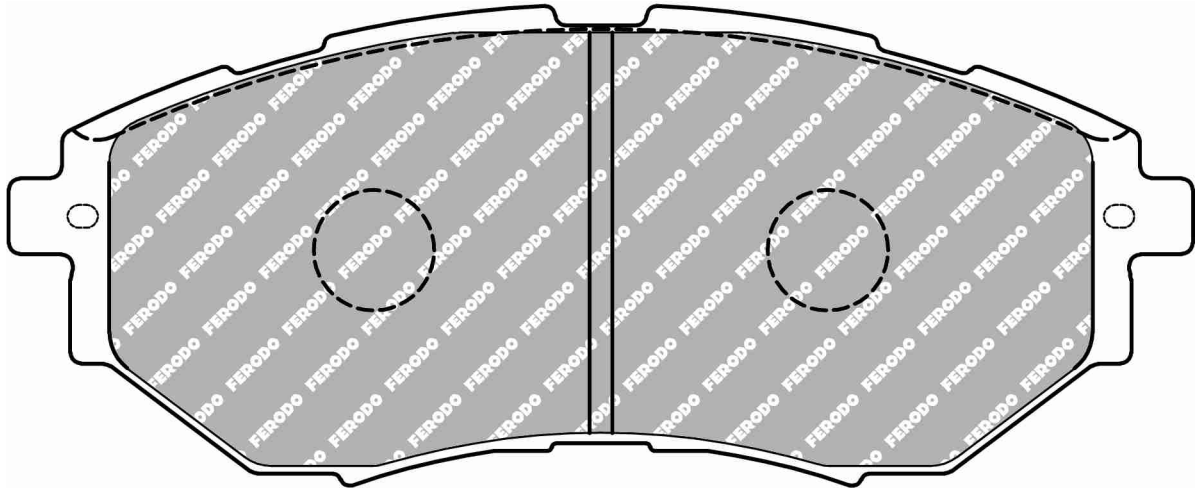

MATERIAL AVAILABILITY						
H	C	R	W	WB	Z	ZB
✓						

CROSS REFERENCE	
FMSI	D1078
HAWK	HB533
MINTEX	MDB2704
WVA	24222 17,90

FCP4044

WVA No: 24408 19,40



188.0mm = 7.402"
188.0mm = 7.402"



72.8mm = 2.866"
73.6mm = 2.898"



18.3mm = 0.720"
18.3mm = 0.720"

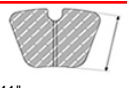

62.0mm = 2.441"
62.0mm = 2.441"

AUDI Front, FORD Front

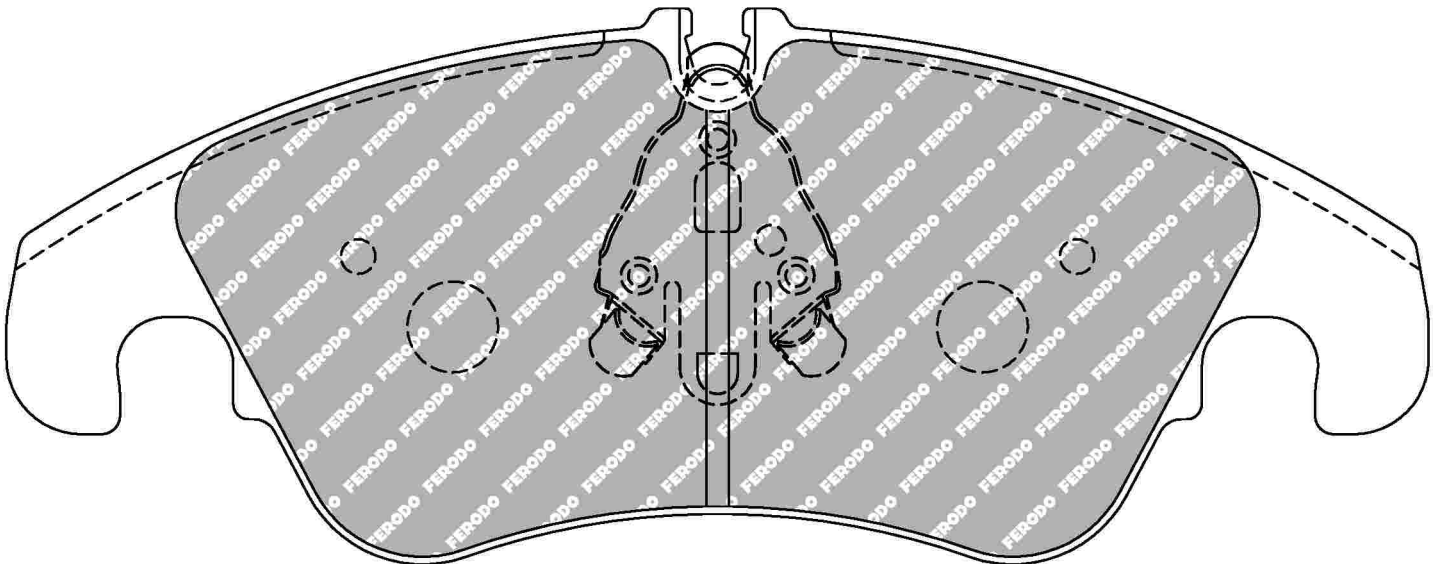
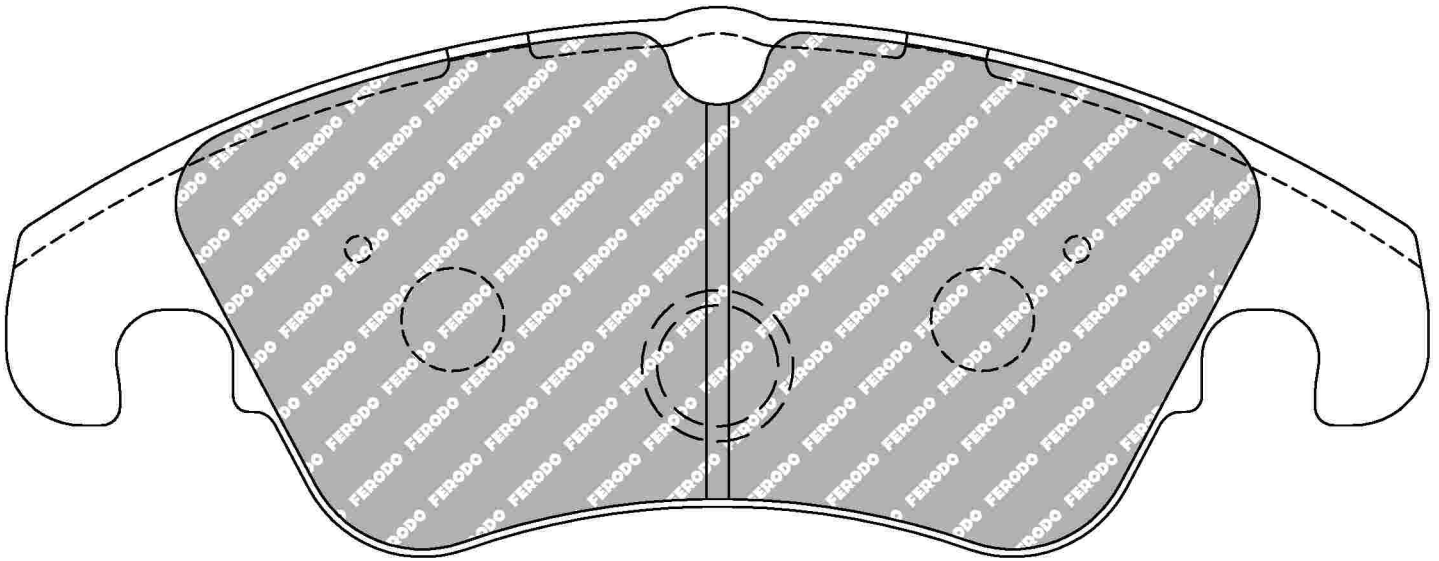

MATERIAL AVAILABILITY						
H	C	R	W	WB	Z	ZB
✓		✉				

CROSS REFERENCE	
MINTEX	MDB2934
OE AUDI	8K0698151 / B
PAGID	1748
PAGID	8096
WVA	24408 19,40
WVA	24409 19,40
WVA	24743 19,40

- ✓ Available
- ✗ Out of Range
- ✚ Exhausting
- ✉ Make to order
- 📄 In Introduction

FCP4045

WVA No: 24705 20,00



155.1mm = 6.106"
155.1mm = 6.106"



72.3mm = 2.846"
67.0mm = 2.638"



20.0mm = 0.787"
20.0mm = 0.787"

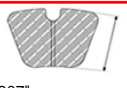

58.6mm = 2.307"
58.6mm = 2.307"

AUDI Front, JAGUAR Front

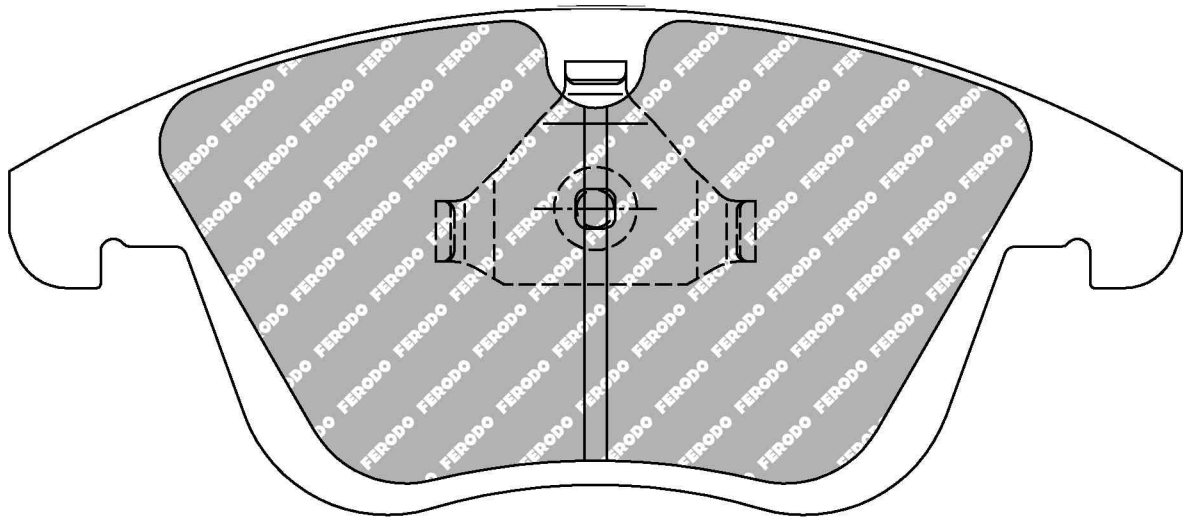
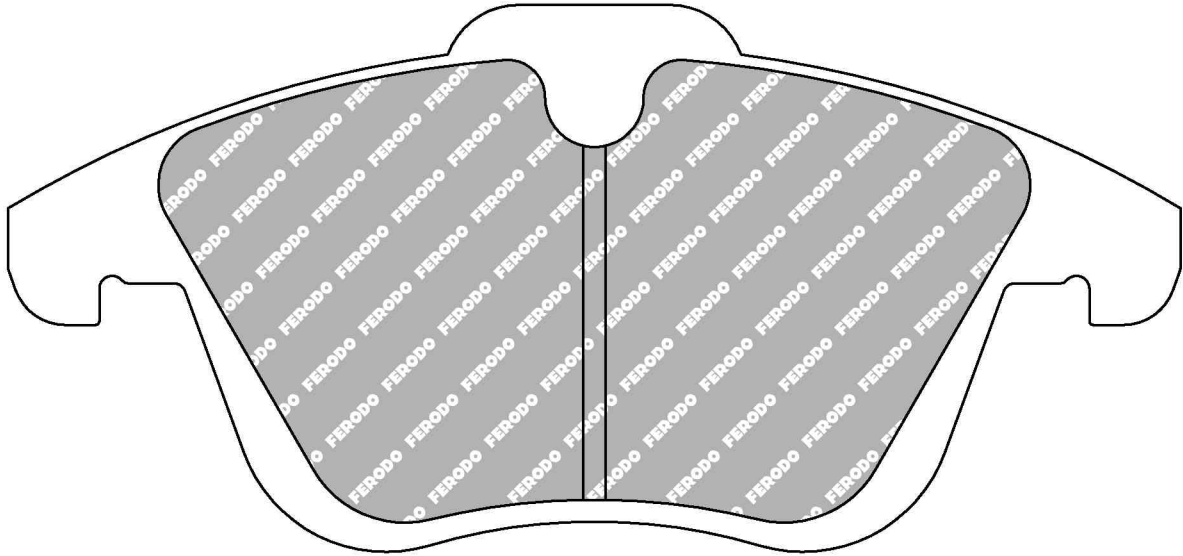

MATERIAL AVAILABILITY						
H	C	R	W	WB	Z	ZB
✓						

CROSS REFERENCE	
MINTEX	MDB2952
OE AUDI	8K0698151A
PAGID	1760
WVA	24705 20,00
WVA	24706 20,00
WVA	24707 20,00

FCP4050

WVA No: 24606 17,50



116.4mm = 4.583"



58.8mm = 2.315"



17.8mm = 0.701"



48.1mm = 1.894"

AUDI Rear, PORSCHE Rear

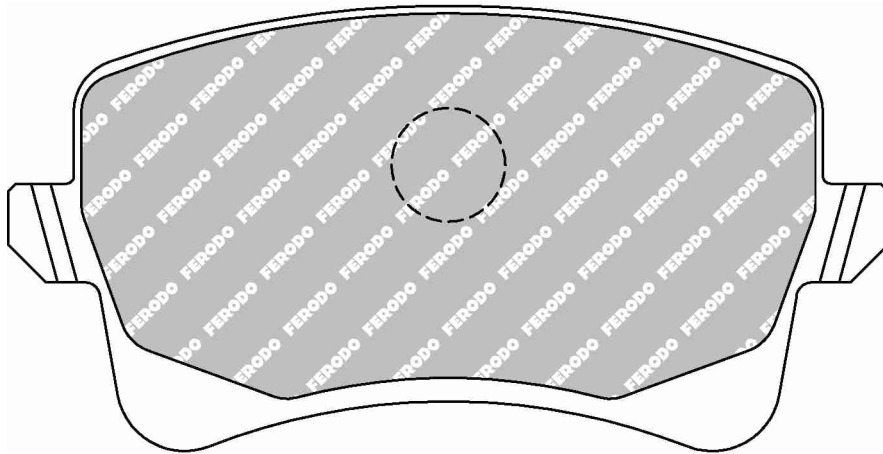

MATERIAL AVAILABILITY						
H	C	R	W	WB	Z	ZB
✓						

CROSS REFERENCE	
MINTEX	MDB2929
OE AUDI	8K0698451
OE AUDI	8K0698451A
PAGID	1736
WVA	24606 17,50

✓ Available ⚠ Exhausting
 ✗ Out of Range 📦 Make to order
 📅 In Introduction

FCP4064

WVA No: 24552 16,10



209.9mm = 8.264"



94.5mm = 3.720"



17.2mm = 0.677"

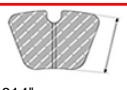

66.4mm = 2.614"

AUDI Front, PORSCHE Front, VOLKSWAGEN Front

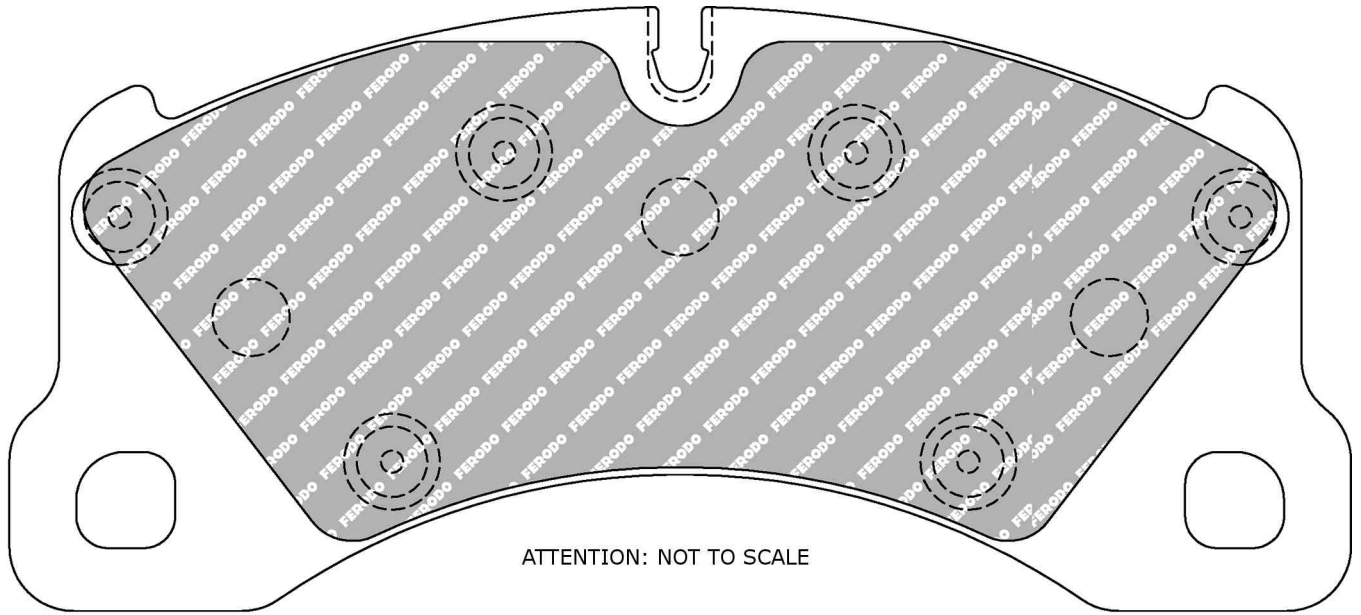

ATTENTION: NOT TO SCALE

MATERIAL AVAILABILITY

H	C	R	W	WB	Z	ZB
✓						

CROSS REFERENCE

MINTEX	MDB2833
PAGID	4917
PAGID	T2056
WVA	24552 16,10
WVA	25007

FCP4080

WVA No: 23984 17,90

FMSI No: D1204



131.5mm = 5.177"
131.5mm = 5.177"



71.6mm = 2.819"
64.1mm = 2.524"



17.9mm = 0.705"
17.9mm = 0.705"



53.0mm = 2.087"
53.0mm = 2.087"

MINI Front

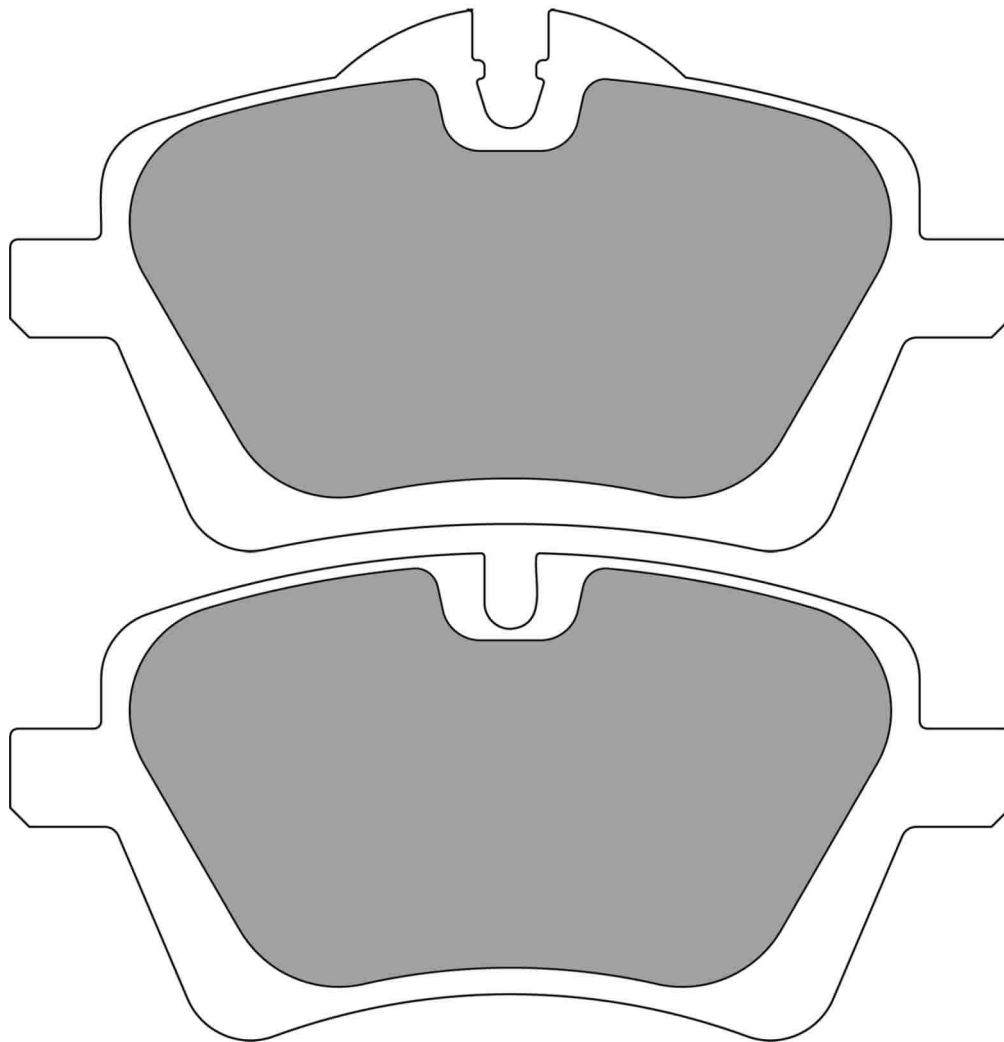

Please Note: does not fit wear indicator

MATERIAL AVAILABILITY						
H	C	R	W	WB	Z	ZB
✓			✓			

CROSS REFERENCE	
EBC	DP21789
FMSI	D1204
HAWK	HB560
MINTEX	MDB2816
WVA	23984 17,90

✓ Available ⚠ Exhausting
 ✗ Out of Range 📦 Make to order
 📌 In Introduction

FCP4081



122.95mm = 4.841"



55.1mm = 2.169"



17.6mm = 0.693"

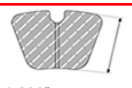

46.7mm = 1.839"

TOYOTA Front

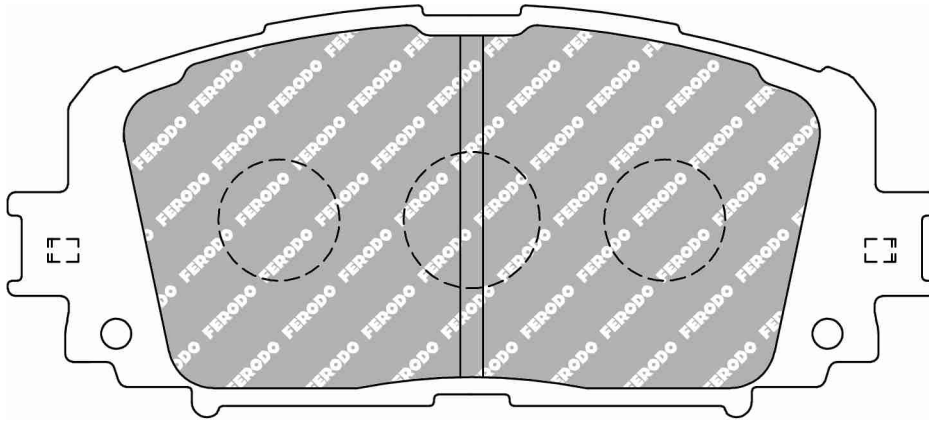

MATERIAL AVAILABILITY						
H	C	R	W	WB	Z	ZB
✓						

FCP4168



86.8mm = 3.417"



63.0mm = 2.480"

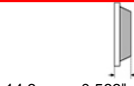

14.3mm = 0.563"

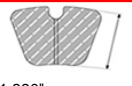

48.0mm = 1.890"

FMSI No: D1368

MITSUBISHI Rear

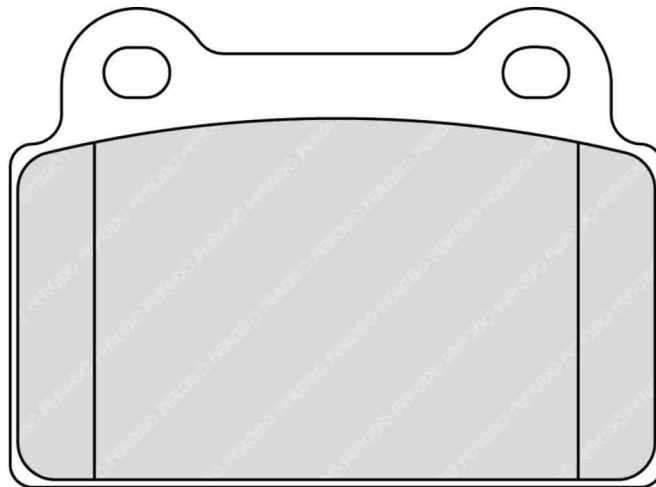

MATERIAL AVAILABILITY						
H	C	R	W	WB	Z	ZB
✓		✗	✓		✓	

CROSS REFERENCE	
BREMBO	XA7.G0.11
BREMBO	XA7.G0.12
FMSI	D1368

FCP4172

WVA No: 24920 15,60

FMSI No: D1346

INFINITI Front, NISSAN Front



127.3mm = 5.012"



75.0mm = 2.953"



16.1mm = 0.634"

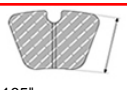

55.0mm = 2.165"

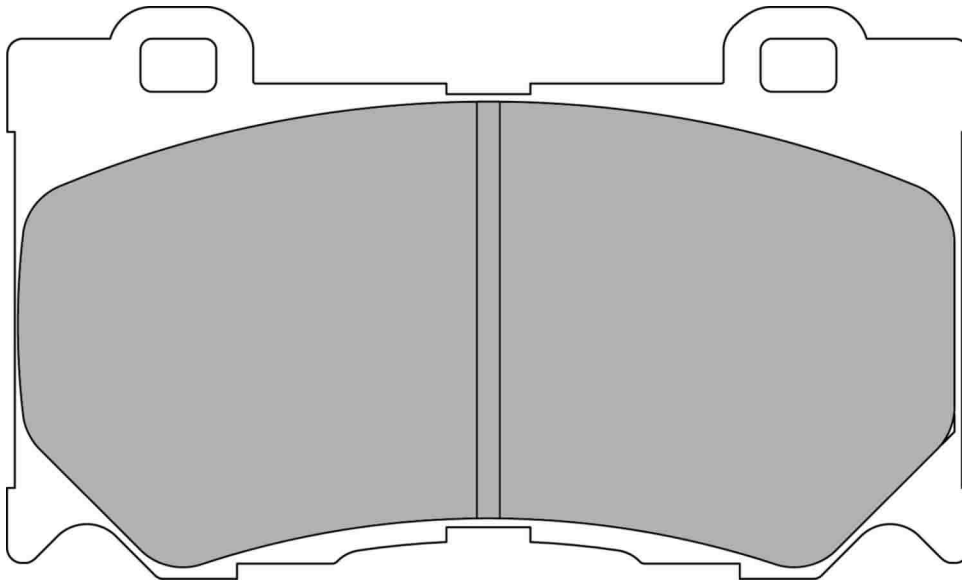

MATERIAL AVAILABILITY						
H	C	R	W	WB	Z	ZB
✓						

CROSS REFERENCE	
FMSI	D1346
HAWK	HB601 .626
WVA	24920 15,60

FCP4173

FMSI No: D1347

INFINITI Rear, NISSAN Rear



99.7mm = 3.925"



60.0mm = 2.362"



13.4mm = 0.528"

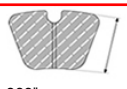

47.4mm = 1.866"

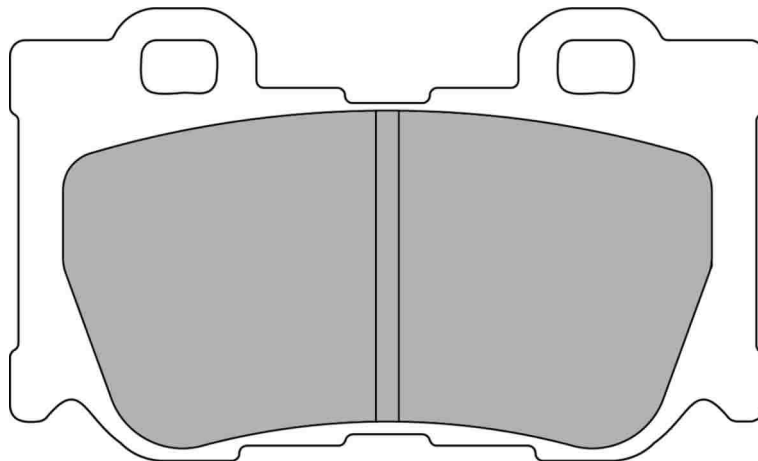

MATERIAL AVAILABILITY						
H	C	R	W	WB	Z	ZB
✓						

CROSS REFERENCE	
FMSI	D1347
HAWK	HB602 .545
MINTEX	MDB3050

- ✓ Available
- ✗ Out of Range
- 🔧 In Introduction
- ⚠ Exhausting
- 📦 Make to order

FCP4187

WVA No: 24854 16,70

FMSI No: D1124

SCION Rear, SUBARU Rear, TOYOTA Rear



110.6mm = 4.354"



39.7mm = 1.563"



16.7mm = 0.657"

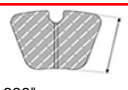

34.0mm = 1.339"

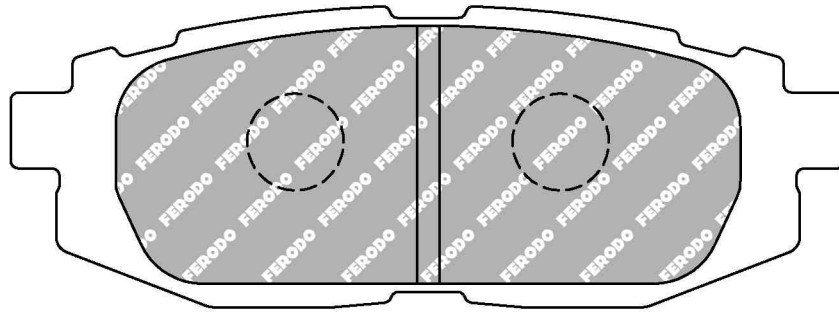

MATERIAL AVAILABILITY						
H	C	R	W	WB	Z	ZB
✓			✓			

CROSS REFERENCE	
EBC	DP21758
ENDLESS	EP472
FMSI	D1124
HAWK	HB671
MINTEX	MDB3006
PAGID	8175
WVA	24854 16,70

FCP4191

WVA No: 23313 20,30 - 24255 20,30

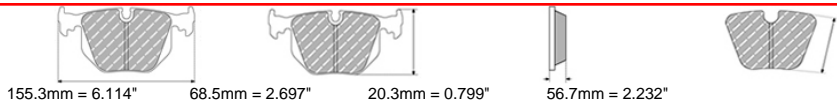

BMW Front

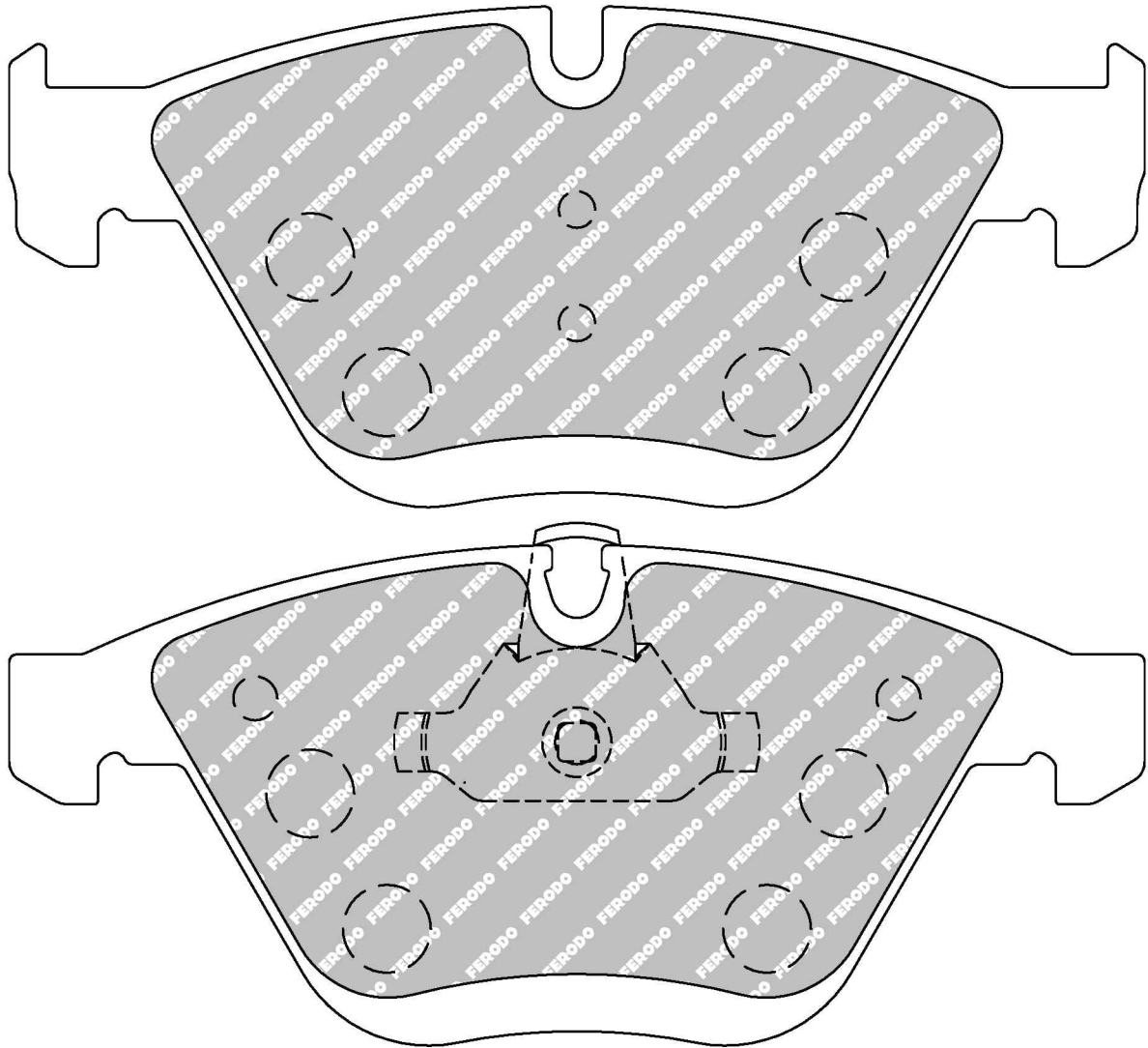

MATERIAL AVAILABILITY						
H	C	R	W	WB	Z	ZB
✓						

CROSS REFERENCE	
MINTEX	MDB2960
MINTEX	MDB3092
PAGID	8053
WVA	23313 20,30 - 24255 20,30

- ✓ Available
- ✗ Out of Range
- ⚠ Exhausting
- 📦 Make to order
- 👤 In Introduction

FCP4217

WVA No: 24315 17,10

FMSI No: D1372



87.0mm = 3.425"

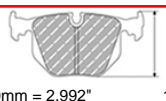

76.0mm = 2.992"

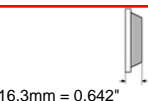

16.3mm = 0.642"

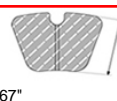

52.5mm = 2.067"

BMW Rear

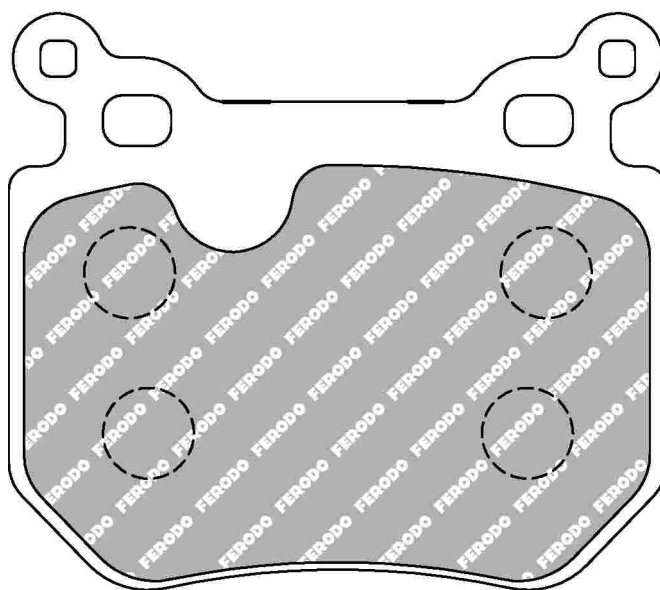

MATERIAL AVAILABILITY						
H	C	R	W	WB	Z	ZB
✓		✉			✉	

CROSS REFERENCE	
FMSI	D1372
HAWK	HB604x.598
MINTEX	MDB2828
OE BMW	34 216 784808
OE BMW	34 216 791421
PAGID	8085
PAGID	T1620
WVA	24315 17,10

FCP4218

WVA No: 24316 17,00

FMSI No: D1371

BMW Front, MINI Front

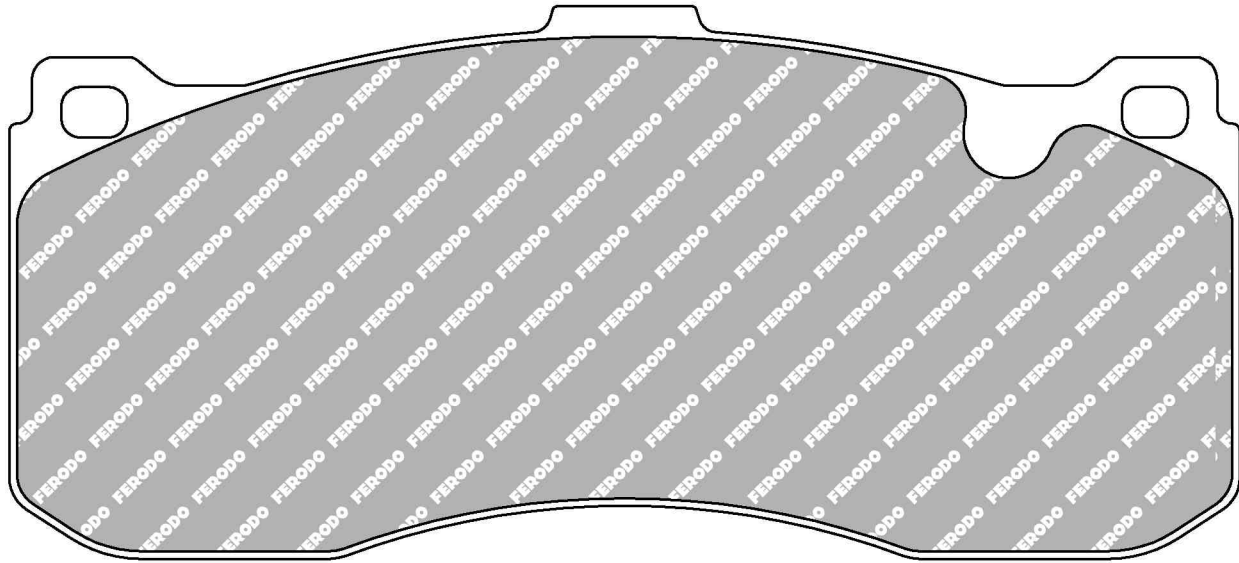
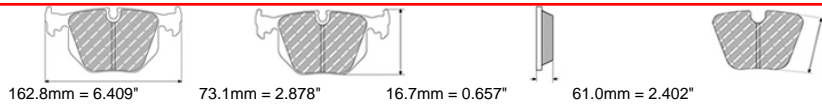

Back-plate design does not allow wear indicator fitment

MATERIAL AVAILABILITY						
H	C	R	W	WB	Z	ZB
✓		✉			✉	

CROSS REFERENCE	
EBC	DP21995-DP31995
FMSI	D1371
HAWK	HB603x.616
MINTEX	MDB2974
OE BMW	34116786044
PAGID	T1784
WVA	24316 17,00

✓ Available ⚠ Exhausting
 ✗ Out of Range ✉ Make to order
 ⓘ In Introduction

FCP4223

WVA No: 23801



155.3mm = 6.114"
156.5mm = 6.161"



73.0mm = 2.874"
73.0mm = 2.874"



20.4mm = 0.803"
20.4mm = 0.803"

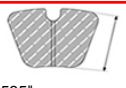

64.4mm = 2.535"
64.4mm = 2.535"

AUDI Front, SEAT Front, SKODA Front, VOLKSWAGEN Front

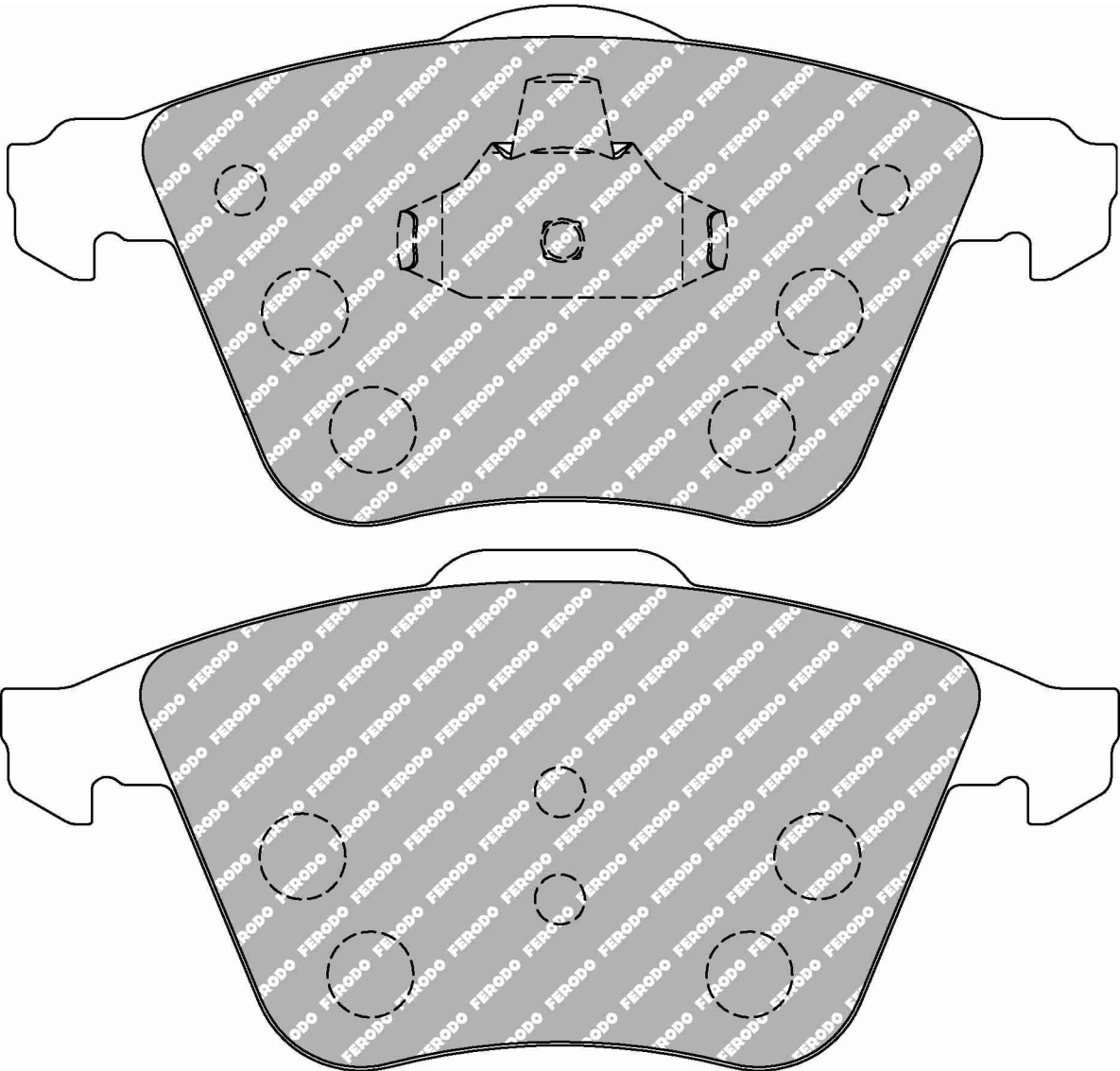

MATERIAL AVAILABILITY

H	C	R	W	WB	Z	ZB
✓						

CROSS REFERENCE

OE AUDI	8J0698151A
OE AUDI	8J0698151F
OE VOLKSWAGEN	8J0698151F
OE VOLKSWAGEN	8P0698151
PAGID	T1350
TRW	GDB1809
WVA	23801

3196

FERODO

RACING
Updated on 17th Aug 2018

✓ Available
 ⚠ Exhausting
✗ Out of Range
 📦 Make to order
🔄 In Introduction

FCP4249

WVA No: 24709 18,00 - 24710 18,00

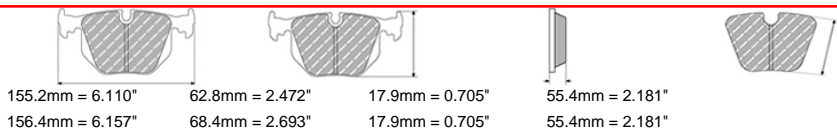

RENAULT Front

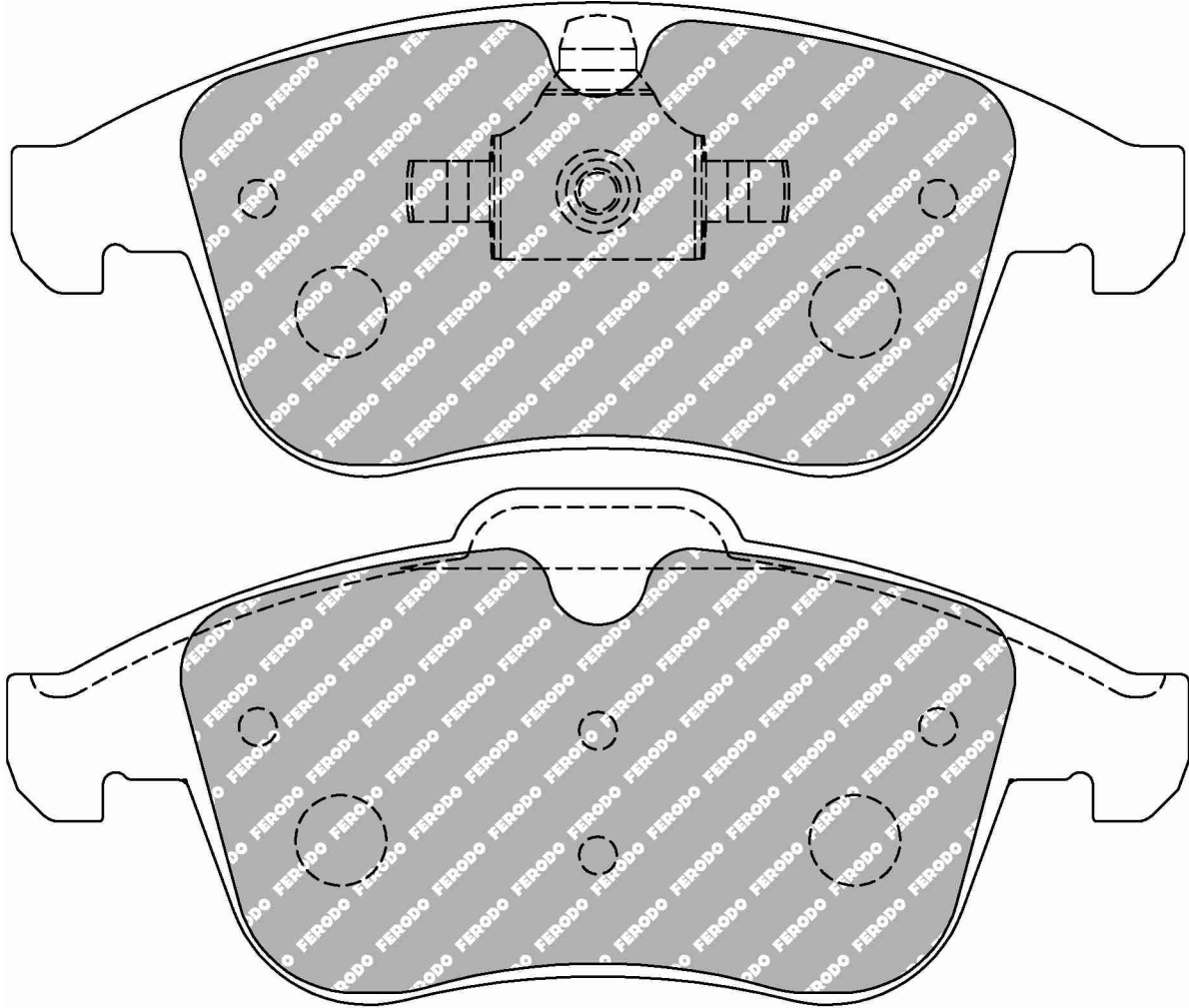

MATERIAL AVAILABILITY						
H	C	R	W	WB	Z	ZB
✓			✓		✉	

CROSS REFERENCE	
MINTEX	MDB3044
OE Renault	410605055R
OE Renault	440608746R
WVA	24709 18,00 - 24710 18,00

✓ Available ⚠ Exhausting
 ✗ Out of Range ✉ Make to order
 📅 In Introduction

FCP4262

WVA No: 25031



148.2mm = 5.835"



60.9mm = 2.398"



18.1mm = 0.713"

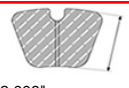

51mm = 2.008"

CHEVROLET Front, OPEL Front, VAUXHALL Front

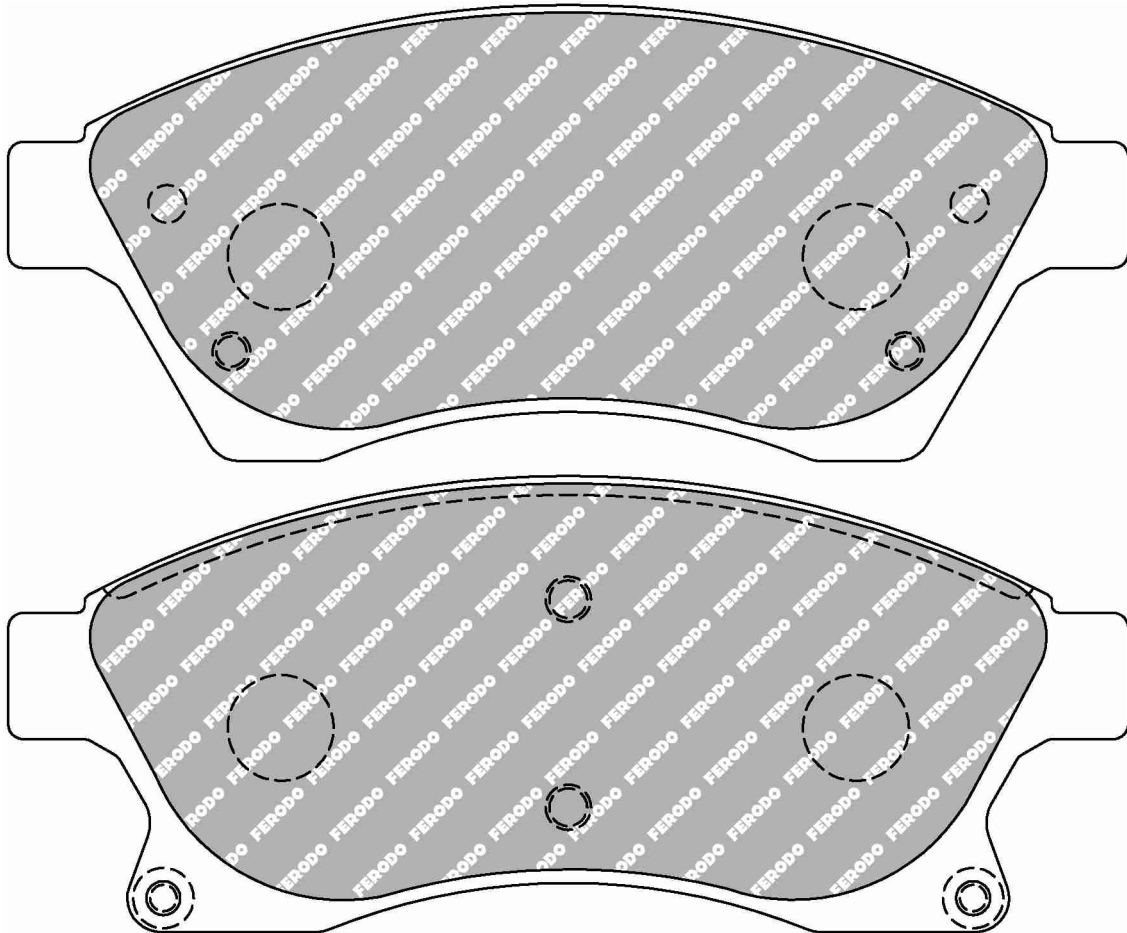

H available from May 2018

MATERIAL AVAILABILITY						
H	C	R	W	WB	Z	ZB

CROSS REFERENCE	
WVA	25031

FCP4308

WVA No: 25156, 25157

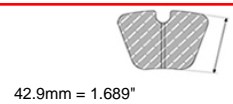
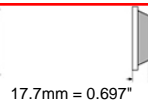
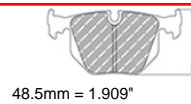
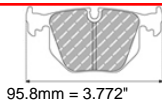

ALFA ROMEO Rear

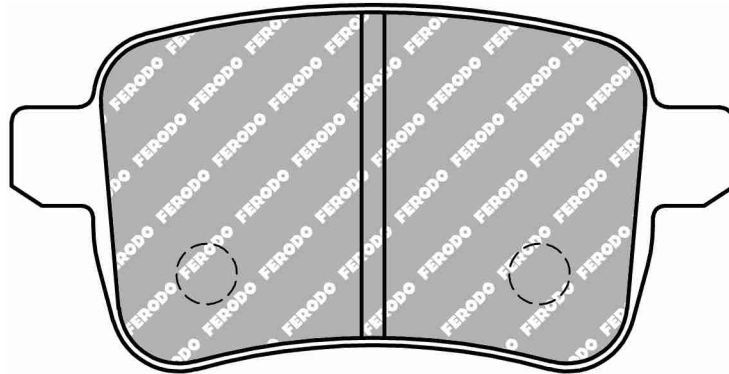

Available from May 2018

MATERIAL AVAILABILITY						
H	C	R	W	WB	Z	ZB

CROSS REFERENCE	
BREMBO	P23133
LUCAS/TRW	GDB1905
OE ALFA ROMEO	71770092
OE ALFA ROMEO	77365357
PAGID	T2011
WVA	25156, 25157

FCP4316

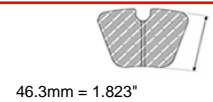
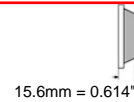
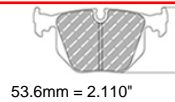
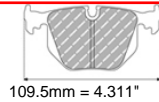

AUDI Rear, SEAT Rear, SKODA Rear, VOLKSWAGEN Rear

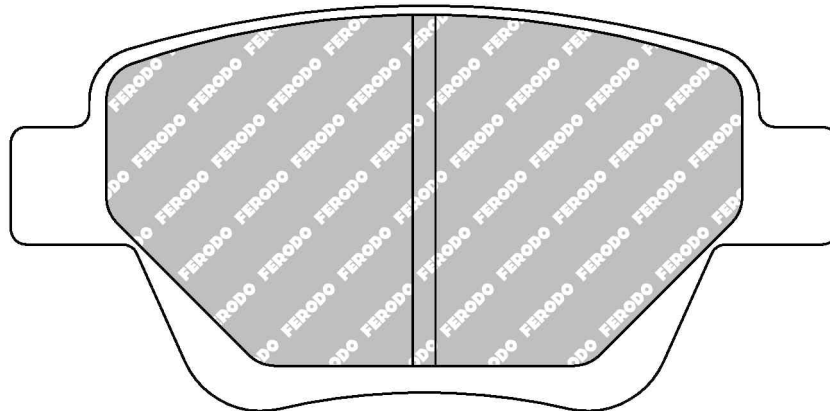

MATERIAL AVAILABILITY						
H	C	R	W	WB	Z	ZB

CROSS REFERENCE	
MINTEX	MDB2972
PAGID	4936

FCP4327

WVA No: 24680



145.55mm = 5.730"



56.6mm = 2.228"



15.5mm = 0.610"

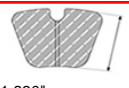

48mm = 1.890"

NISSAN Front, TOYOTA Front

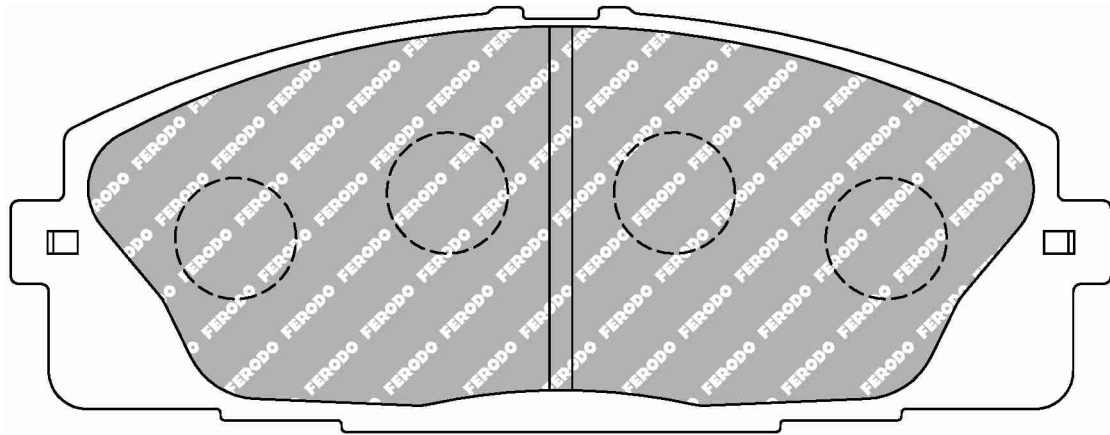

MATERIAL AVAILABILITY						
H	C	R	W	WB	Z	ZB
✓						

CROSS REFERENCE	
WVA	24680

3200

FERODO
RACING
Updated on 17th Aug 2018

✓ Available ⚠ Exhausting
 ✗ Out of Range 📦 Make to order
 🚧 In Introduction

FCP4353

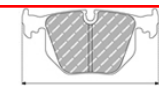

149.5mm = 5.886"

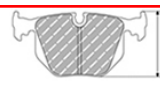

52.5mm = 2.067"



17.2mm = 0.677"

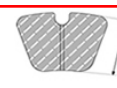

46.5mm = 1.831"

ABARTH Front

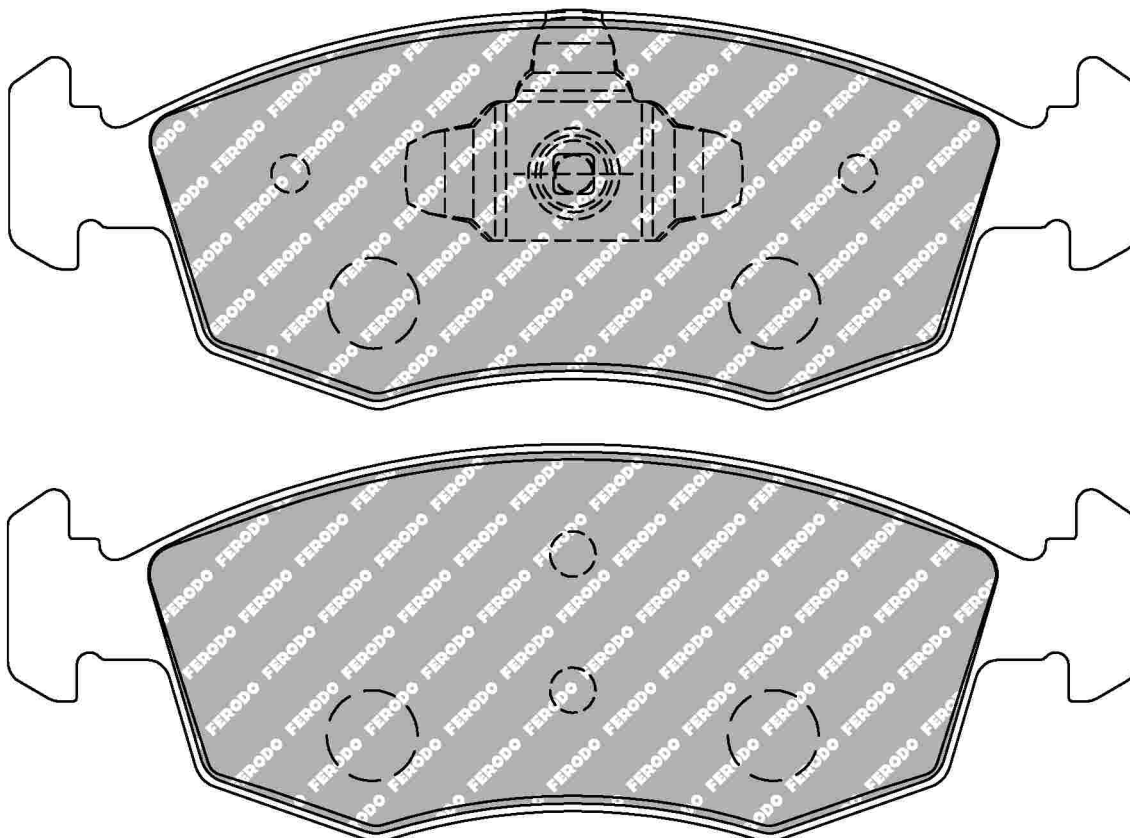

MATERIAL AVAILABILITY						
H	C	R	W	WB	Z	ZB

CROSS REFERENCE	
MINTEX	MDB3208
MINTEX	MDB3233

- Available
- Exhausting
- Out of Range
- Make to order
- In Introduction

FCP4354



167.2mm = 6.583"



59.7mm = 2.350"



17.6mm = 0.693"

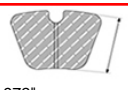

50.1mm = 1.972"

LEXUS Front, TOYOTA Front

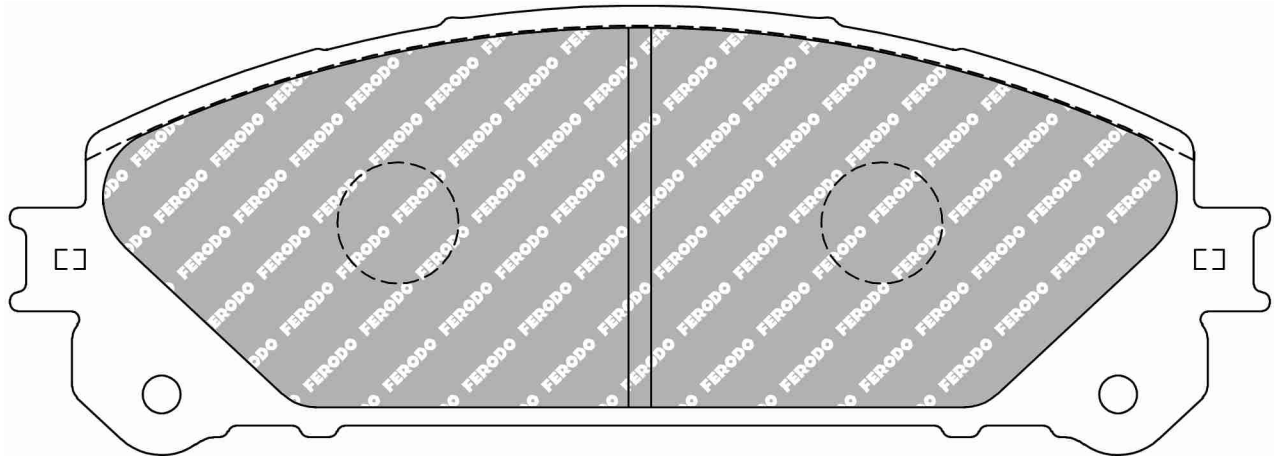

MATERIAL AVAILABILITY						
H	C	R	W	WB	Z	ZB
✓						

CROSS REFERENCE	
LUCAS/TRW	GDB3484
MINTEX	MDB3114
OE LEXUS	0446548150
OE LEXUS	0446548160
OE LEXUS	0446548190
PAGID	T1997

FCP4379

WVA No: 24659



189.7mm = 7.469"



96.4mm = 3.795"



16.6mm = 0.654"

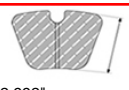

76mm = 2.992"

LAND ROVER Front

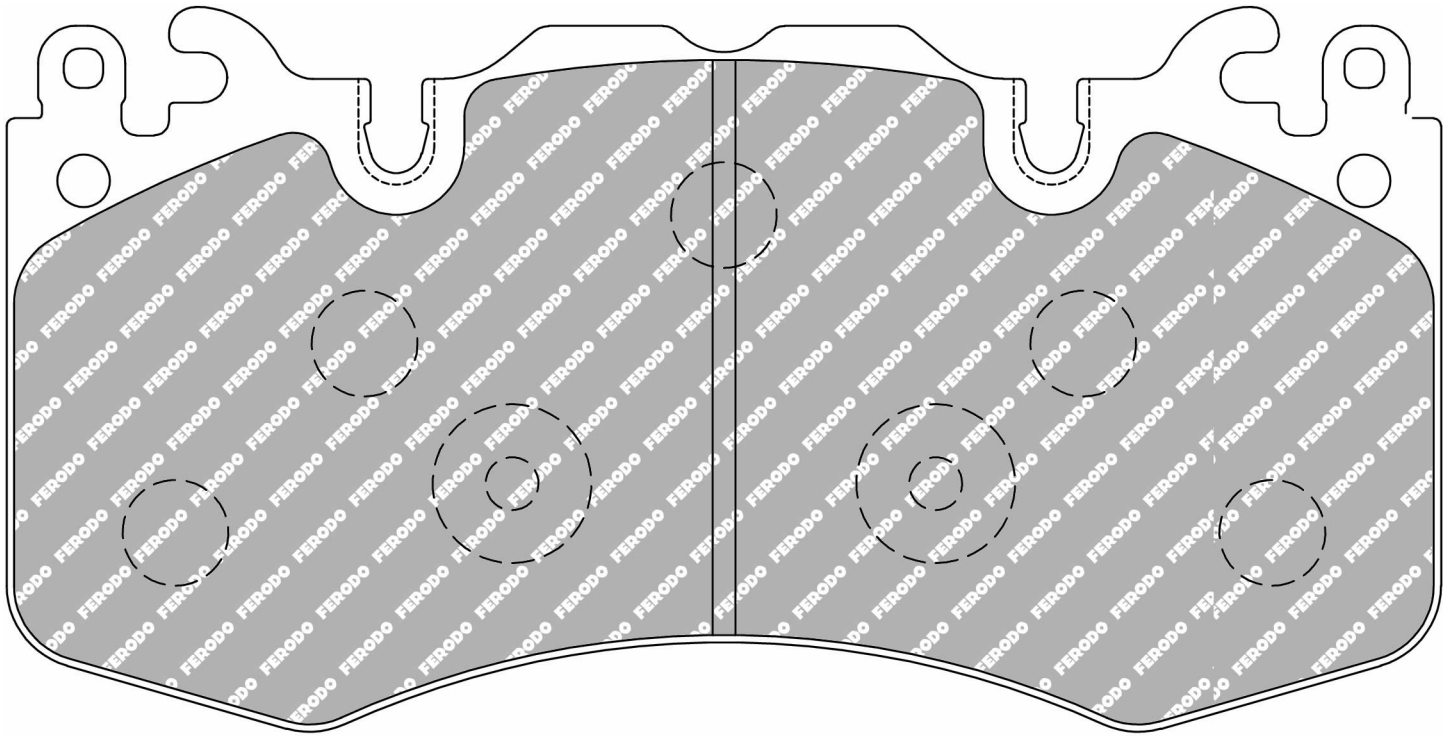

MATERIAL AVAILABILITY

H	C	R	W	WB	Z	ZB
✓						

CROSS REFERENCE

WVA	24659
-----	-------

- ✓ Available
- ✗ Out of Range
- ⓘ In Introduction
- ⚠ Exhausting
- 📦 Make to order

FCP4381

WVA No: 24703



116.2mm = 4.575"
116.2mm = 4.575"



66.3mm = 2.610"
74.5mm = 2.933"



18mm = 0.709"
18mm = 0.709"



63.5mm = 2.500"
63.5mm = 2.500"

BMW Rear

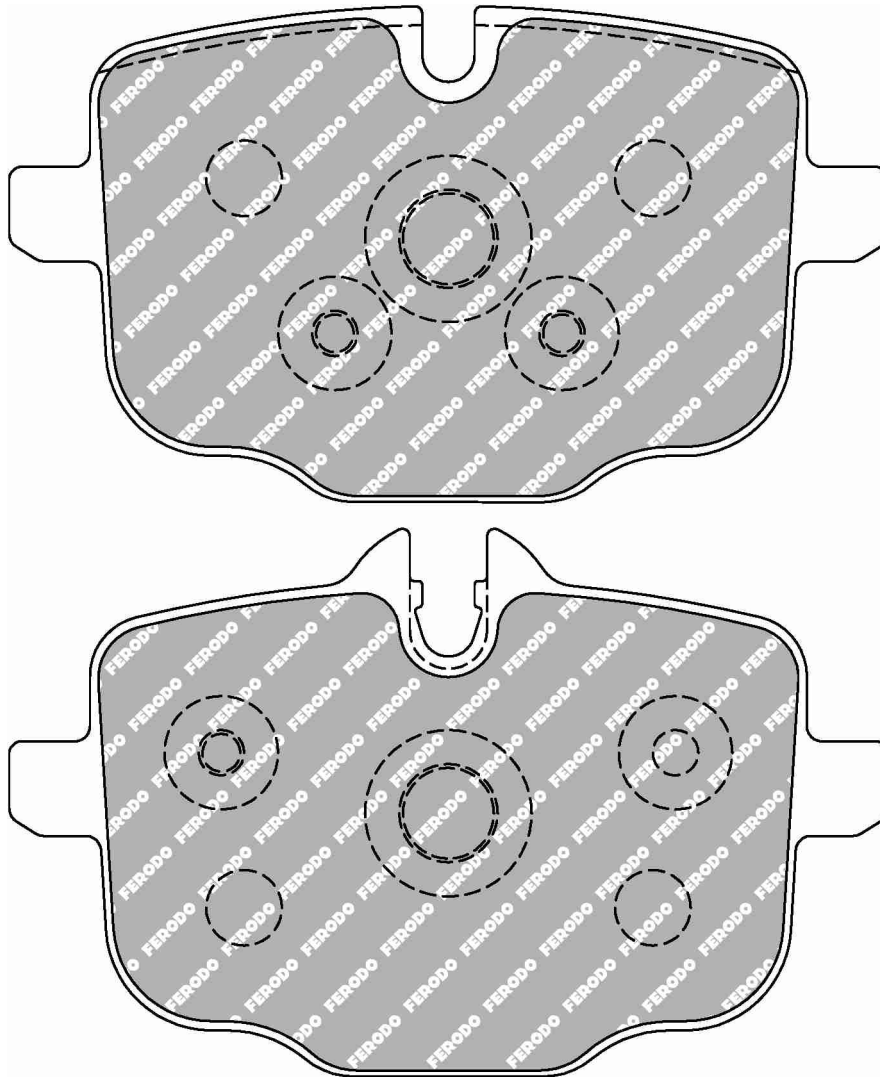

MATERIAL AVAILABILITY

H	C	R	W	WB	Z	ZB
✓						

CROSS REFERENCE

PAGID	4932
WVA	24703

3204

FERODO

RACING
Updated on 17th Aug 2018

✓ Available ⚠ Exhausting
 ✗ Out of Range 🏭 Make to order
 🔄 In Introduction

FCP4394

WVA No: 25199



148.45mm = 5.844"
148.45mm = 5.844"



70mm = 2.756"
70mm = 2.756"



19.2mm = 0.756"
19.2mm = 0.756"



67.7mm = 2.665"
67.7mm = 2.665"

BMW Front

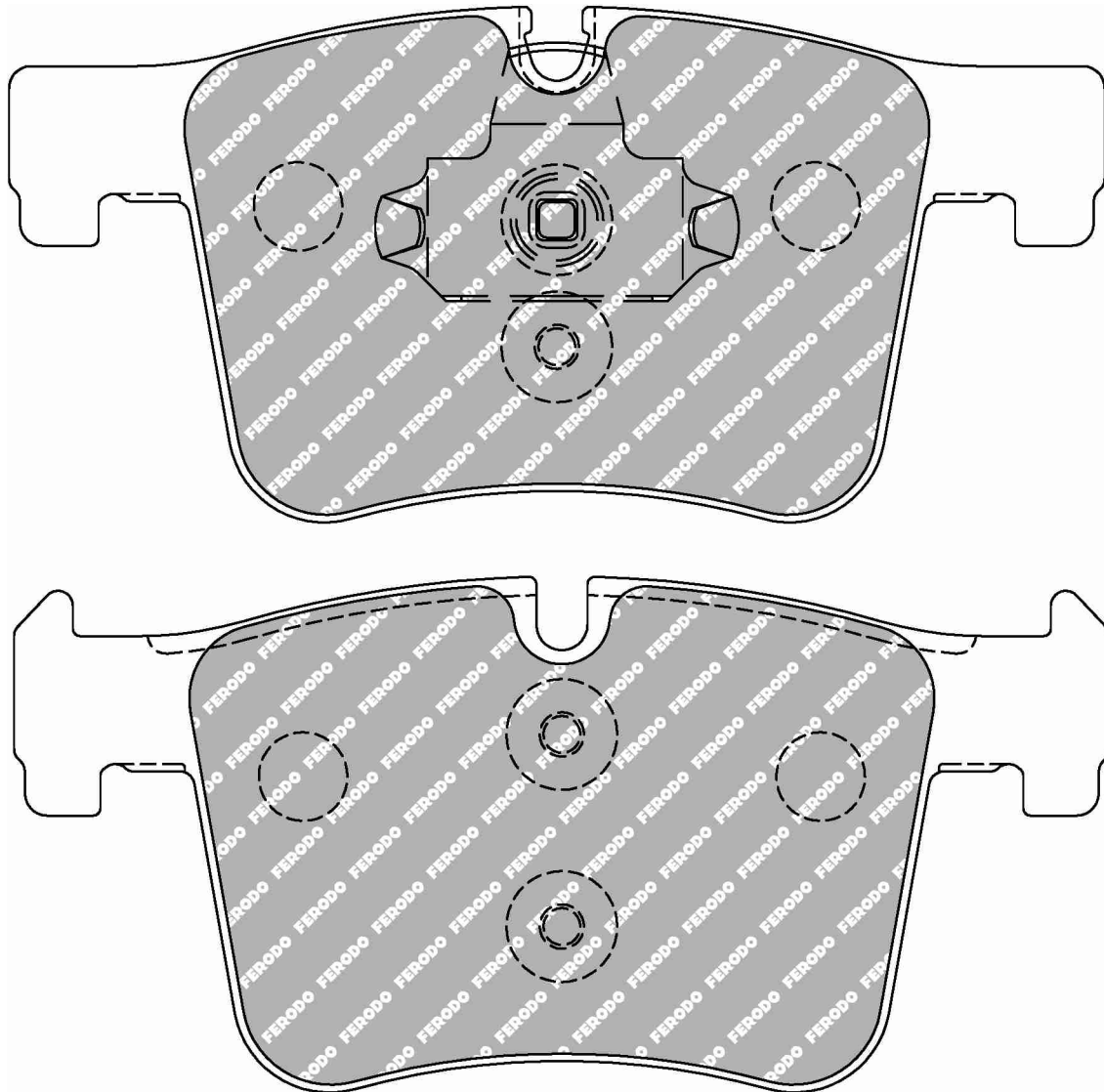

MATERIAL AVAILABILITY						
H	C	R	W	WB	Z	ZB
✓						

CROSS REFERENCE	
WVA	25199

- ✓ Available
- ✗ Out of Range
- ⚠ Exhausting
- 📦 Make to order
- 📅 In Introduction

FCP4404

WVA No: 24979



136.55mm = 5.376"

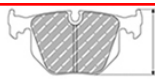

56.9mm = 2.240"



16.9mm = 0.665"

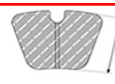

45.25mm = 1.781"

HONDA Front

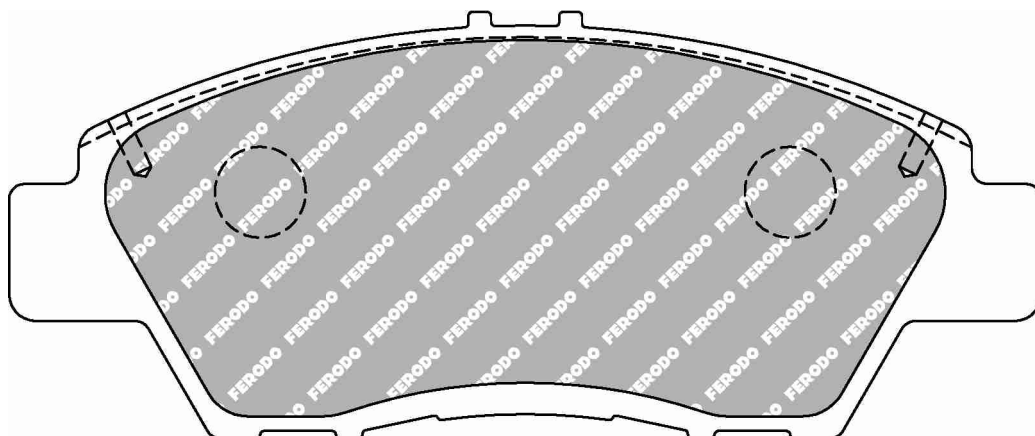

MATERIAL AVAILABILITY						
H	C	R	W	WB	Z	ZB
✓						

CROSS REFERENCE	
WVA	24979

FCP4412

WVA No: 24205



138.7mm = 5.461"
138.7mm = 5.461"



73.9mm = 2.909"
73.9mm = 2.909"



16.7mm = 0.657"
16.7mm = 0.657"

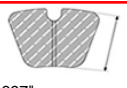

68.5mm = 2.697"
68.5mm = 2.697"

MERCEDES Front

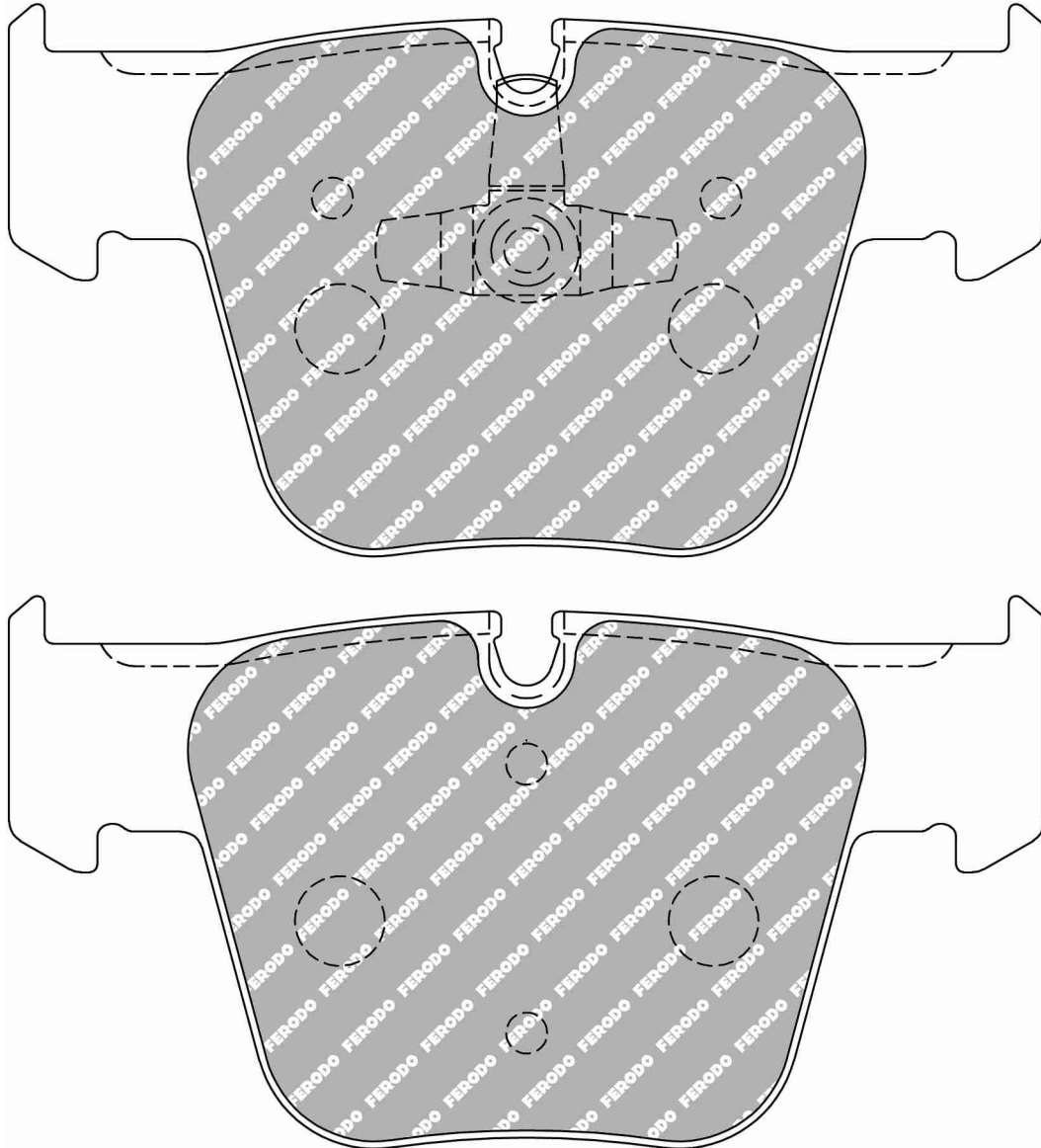

In Introduction - September 2018

MATERIAL AVAILABILITY						
H	C	R	W	WB	Z	ZB

CROSS REFERENCE	
OE MERCEDES	0044207520
WVA	24205

- Available
- Exhausting
- Out of Range
- Make to order
- In Introduction

FCP4413

WVA No: 24180, 24181



141.25mm = 5.561"
141.25mm = 5.561"



61.6mm = 2.425"
61.6mm = 2.425"



16.8mm = 0.661"
16.8mm = 0.661"

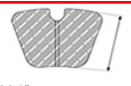

57.5mm = 2.264"
57.5mm = 2.264"

MERCEDES Rear

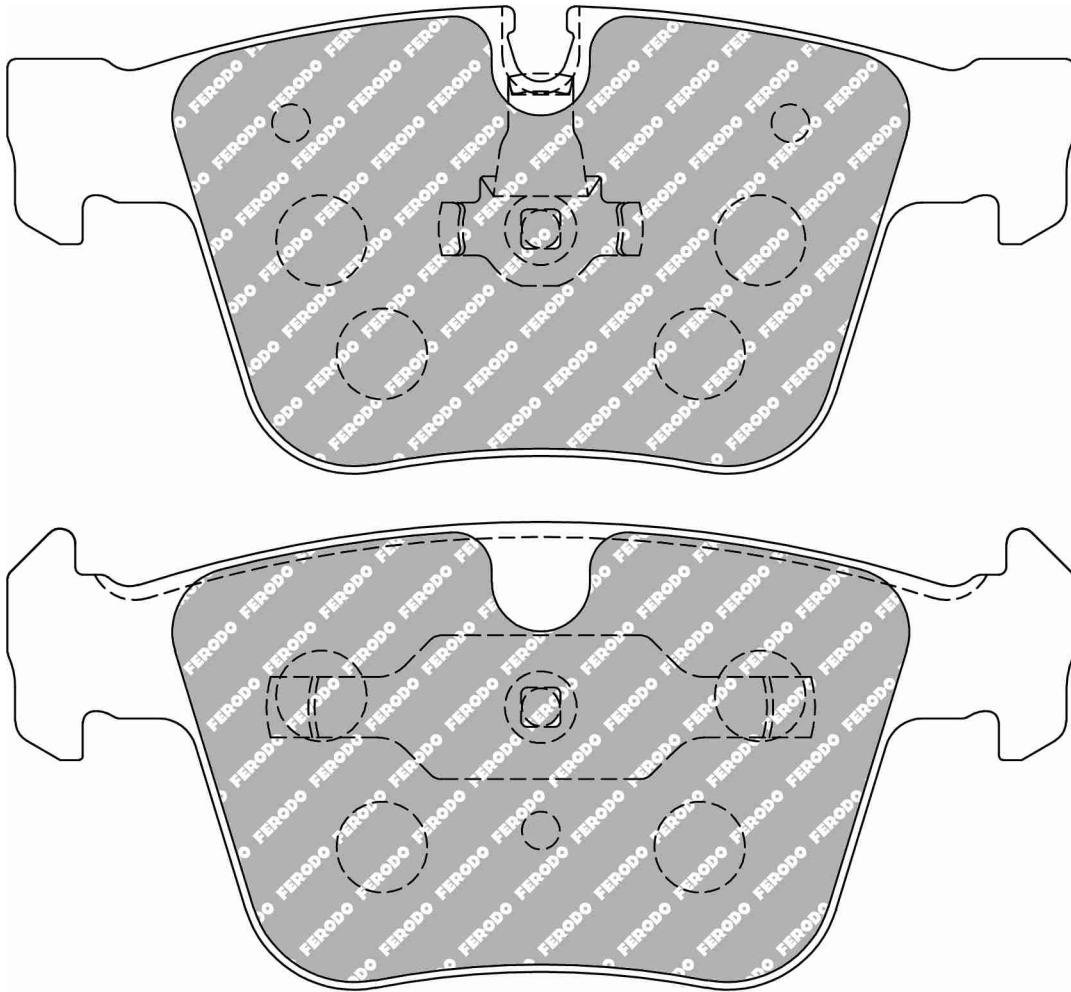

In Introduction - September 2018

MATERIAL AVAILABILITY

H	C	R	W	WB	Z	ZB

CROSS REFERENCE

OE MERCEDES	1644201020
OE MERCEDES	1644202420
PAGID	T1735
WVA	24180, 24181

3208

FERODO

RACING
Updated on 17th Aug 2018

Available
 Out of Range
 In Introduction
 Exhausting
 Make to order

FCP4416

WVA No: 25737 17,40 - 25736 17,40



180.3mm = 7.098"



65.9mm = 2.594"



18.0mm = 0.709"



55.5mm = 2.185"

FORD Front

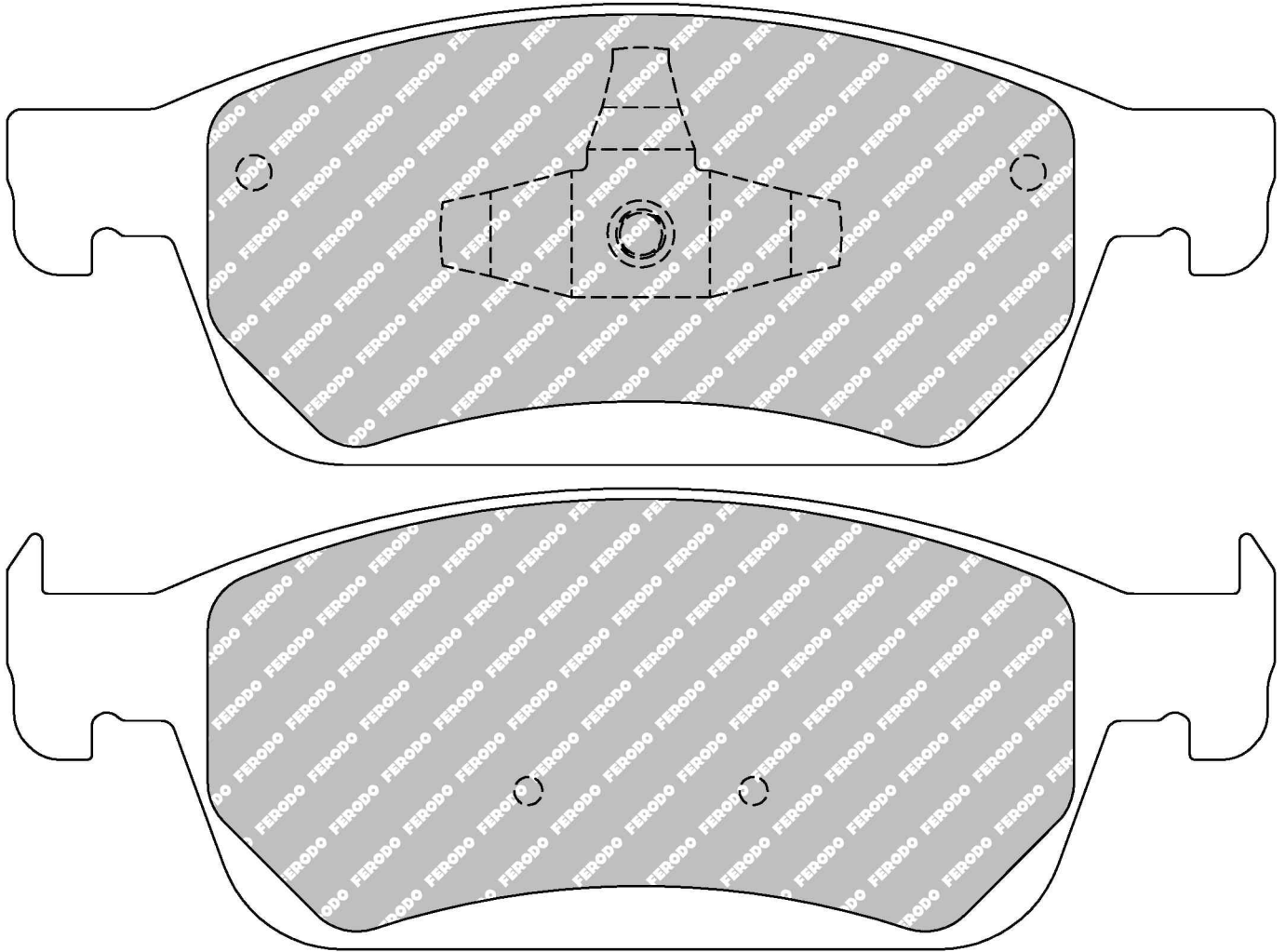

MATERIAL AVAILABILITY						
H	C	R	W	WB	Z	ZB
✓						

CROSS REFERENCE	
MINTEX	MDB3364
WVA	25737 17,40 - 25736 17,40

- ✓ Available
- ✗ Out of Range
- ⓘ In Introduction
- ⚠ Exhausting
- 📦 Make to order

FCP4425

WVA No: 24738 19,8



175.2mm = 6.898"

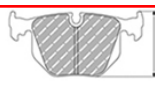

69.5mm = 2.736"



19.8mm = 0.780"

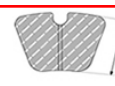

64.5mm = 2.539"

AUDI Front, SEAT Front, SKODA Front, VOLKSWAGEN Front

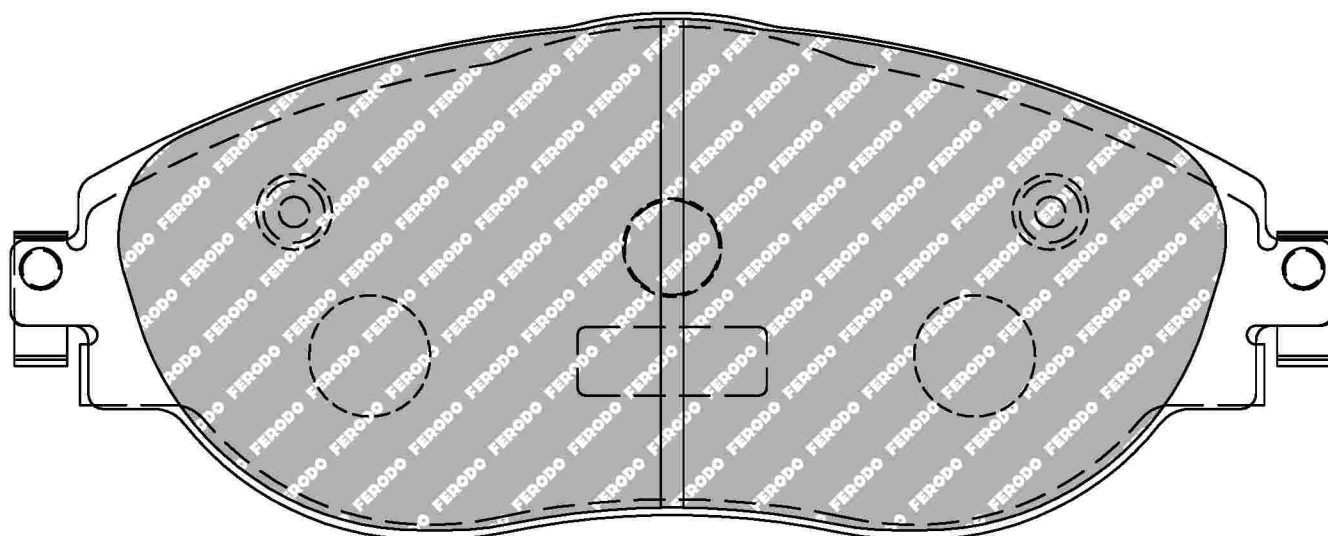

N.B. The two side clips must be opened in order to create a sufficient tension between pad and caliper to avoid pad movement

MATERIAL AVAILABILITY

H	C	R	W	WB	Z	ZB
✓						

CROSS REFERENCE

MINTEX	MDB3173
PAGID	8201
WVA	24738 19,8

3210

FERODO

RACING

Updated on 17th Aug 2018

✓ Available ⚠ Exhausting
✗ Out of Range 📦 Make to order
🔧 In Introduction

FCP4426

WVA No: 24283

FMSI No: D1454

FORD Front, MAZDA Front, SUZUKI Front



125.7mm = 4.949"



52.0mm = 2.047"



16.4mm = 0.646"

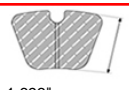

43.0mm = 1.693"

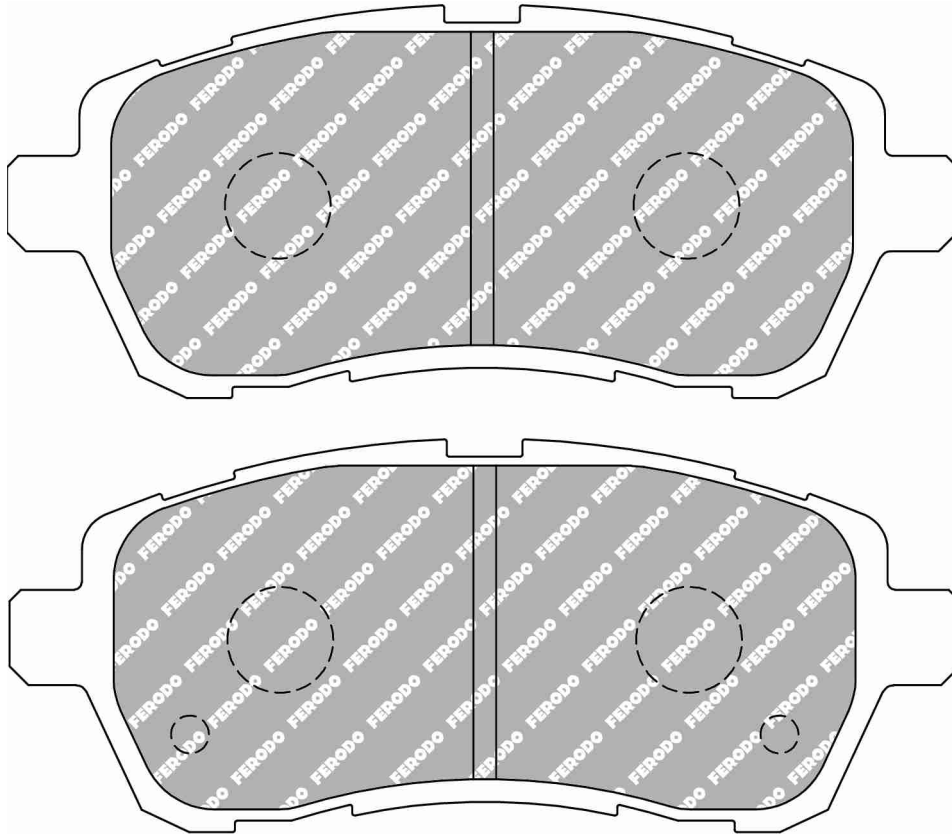

MATERIAL AVAILABILITY						
H	C	R	W	WB	Z	ZB
✓		✓			✓	

CROSS REFERENCE	
EBC	DPX2002
FMSI	D1454
HAWK	HB668
MINTEX	MDB2875
WVA	24283

✓ Available ⚠ Exhausting
 ✗ Out of Range 📦 Make to order
 📅 In Introduction

FCP4430

WVA No: 25258



98.6mm = 3.882"



40.1mm = 1.579"



14.5mm = 0.571"



36.5mm = 1.437"

SUZUKI Rear

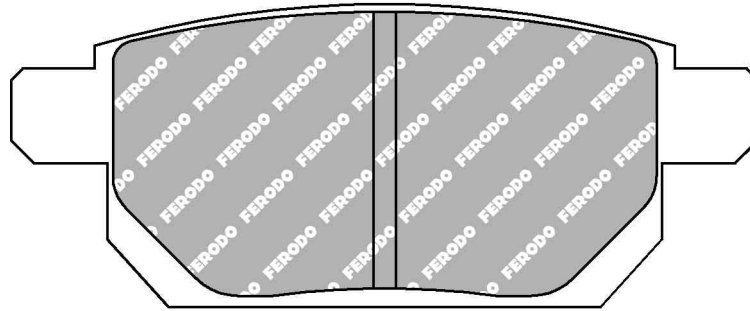

MATERIAL AVAILABILITY						
H	C	R	W	WB	Z	ZB
✓						

CROSS REFERENCE	
MINTEX	MDB3168
WVA	25258

FCP4433

WVA No: 25086 20,20 or 25683-25684 20,30



160.3mm = 6.311"



64.5mm = 2.539"



20.3mm = 0.799"



61.5mm = 2.421"

AUDI Front, SEAT Front, SKODA Front, VOLKSWAGEN Front

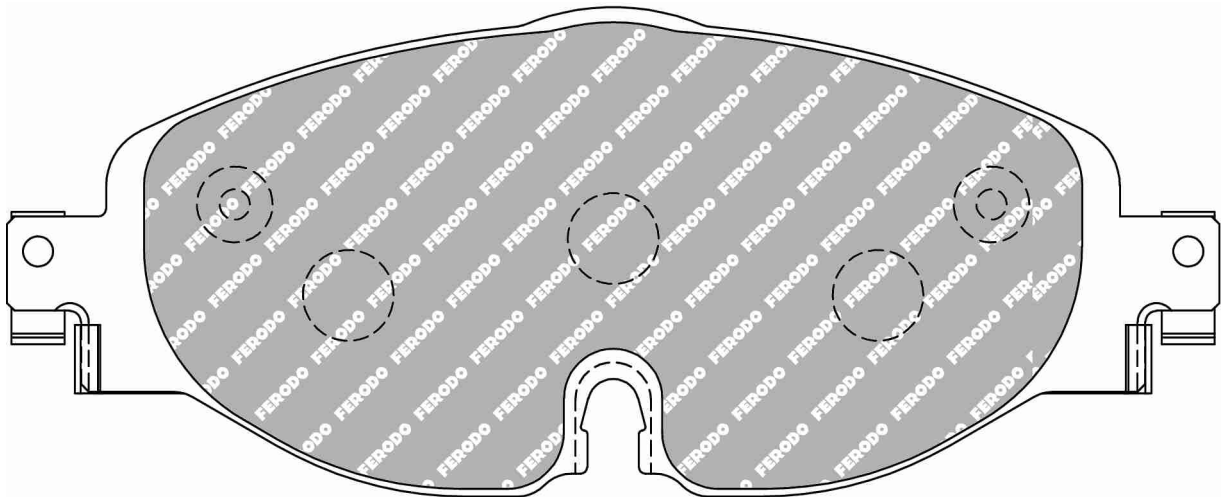

N.B. The two side clips must be opened in order to create a sufficient tension between pad and caliper to avoid pad movement

MATERIAL AVAILABILITY						
H	C	R	W	WB	Z	ZB
✓					✓	

CROSS REFERENCE	
MINTEX	MDB3340
OE AUDI	8V0698151
OE AUDI	8V0698151B
PAGID	T2239
WVA	25086 20,20 or 25683-25684 20,30

FCP4434

WVA No: 25008, 25010



123.25mm = 4.852"
123.25mm = 4.852"



56.2mm = 2.213"
61.2mm = 2.409"



16.6mm = 0.654"
16.6mm = 0.654"

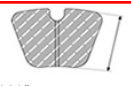

48.5mm = 1.909"
48.5mm = 1.909"

AUDI Rear, SEAT Rear, VOLKSWAGEN Rear

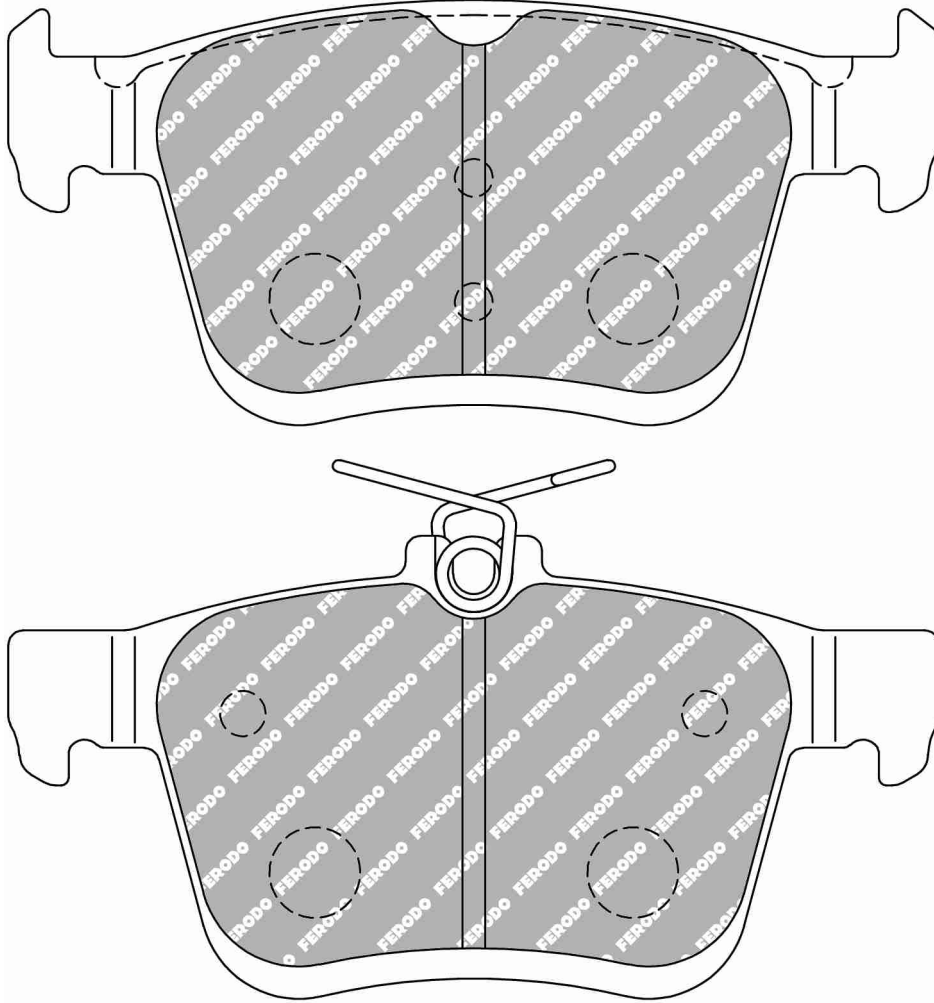

In Introduction : July 2018

MATERIAL AVAILABILITY						
H	C	R	W	WB	Z	ZB

CROSS REFERENCE	
BOSCH	0986494659
OE AUDI	5Q0698451
OE AUDI	8V0698451
OE VOLKSWAGEN	5Q0698451
OE VOLKSWAGEN	8V0698451
PAGID	T1976
TRW	GDB1957
WVA	25008, 25010

- Available
- Exhausting
- Out of Range
- Make to order
- In Introduction

FCP4466

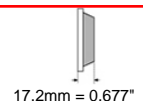

AUDI Front

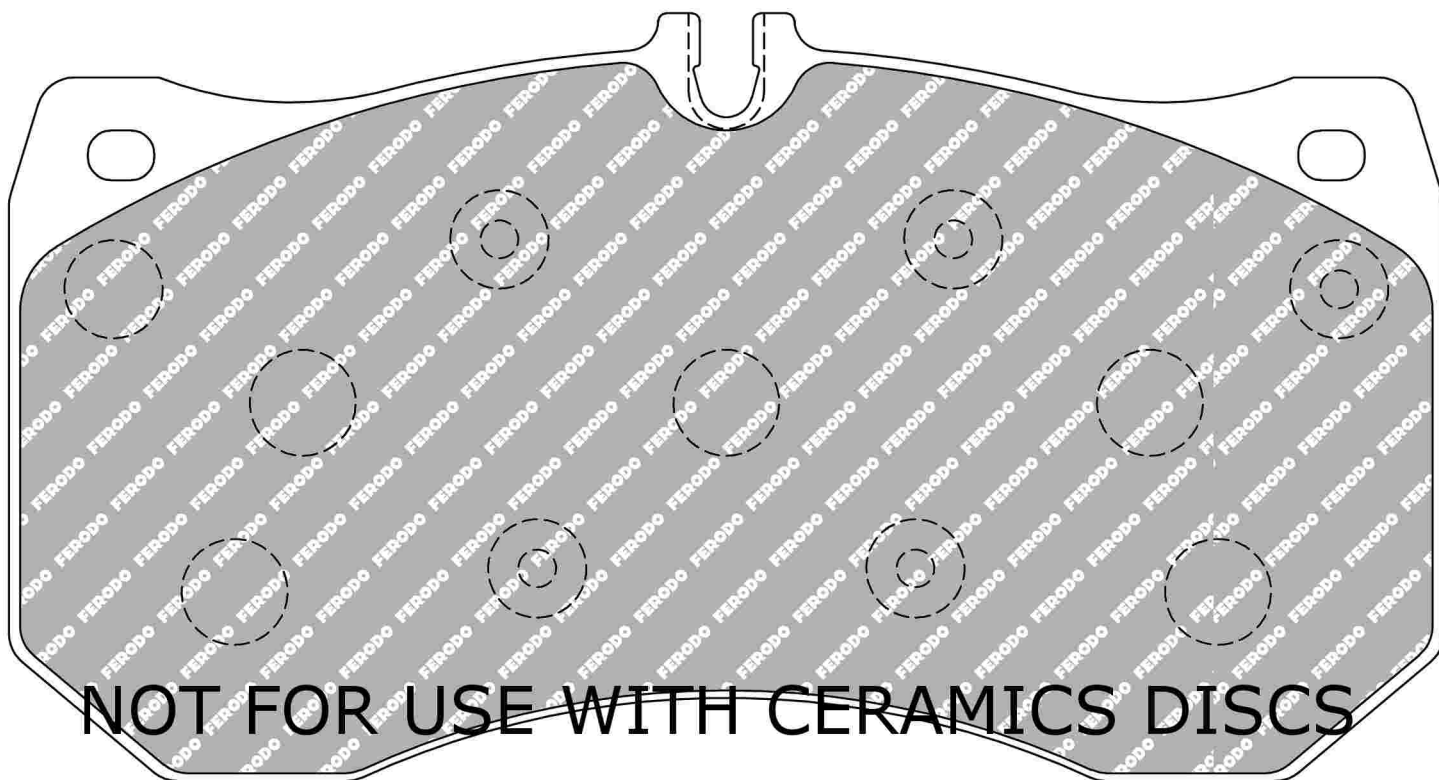

NOT FOR USE WITH CERAMICS DISCS

MATERIAL AVAILABILITY						
H	C	R	W	WB	Z	ZB
✓						

FCP4467



176mm = 6.929"



109.5mm = 4.311"



16.7mm = 0.657"



79.5mm = 3.130"

AUDI Front, PORSCHE Front

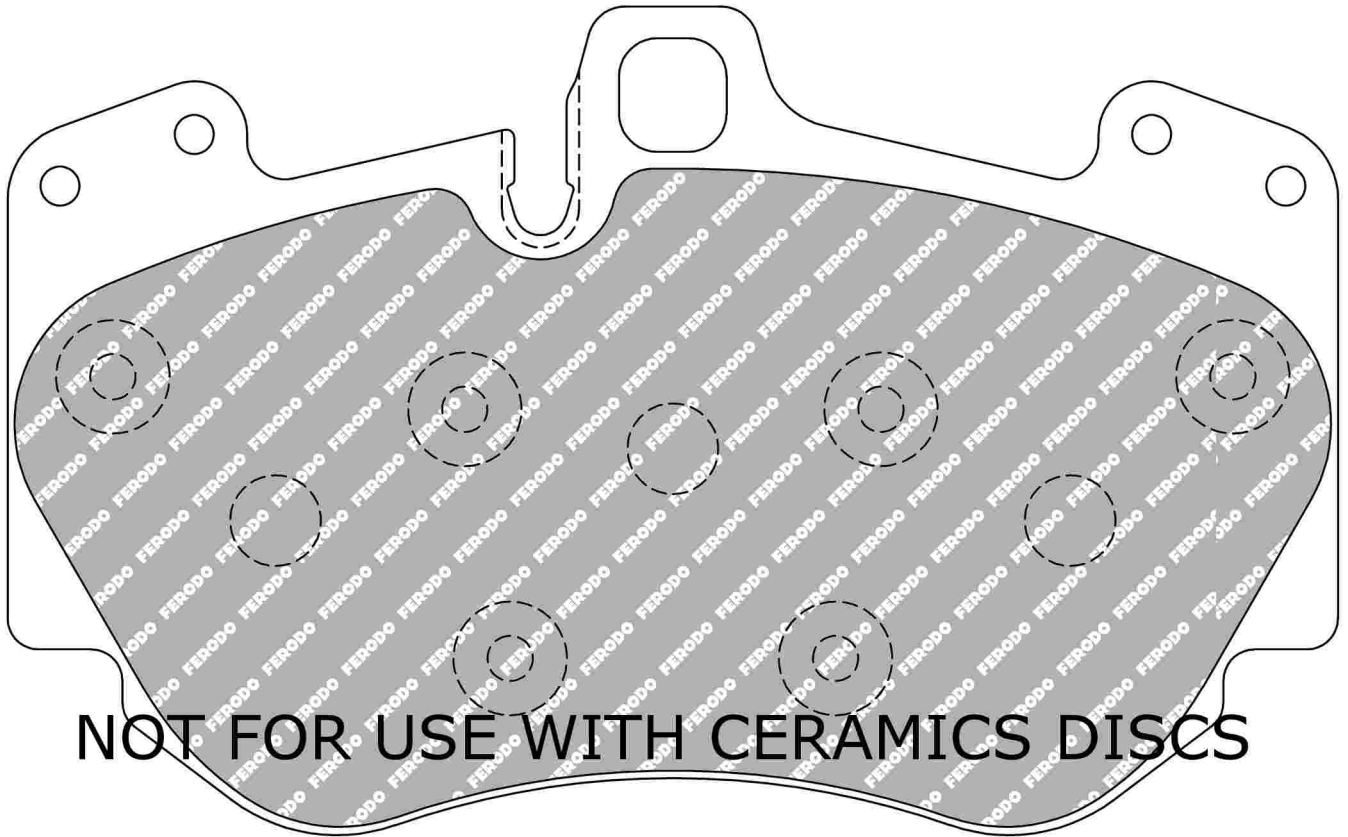

NOT FOR USE WITH CERAMICS DISCS

NOT FOR USE WITH CERAMICS DISCS

MATERIAL AVAILABILITY						
H	C	R	W	WB	Z	ZB
✓						

CROSS REFERENCE	
PAGID	4907

- ✓ Available
- ✗ Out of Range
- ⓘ In Introduction
- ⚠ Exhausting
- 📦 Make to order

FCP4468

WVA No: 24847



187.7mm = 7.390"



93.2mm = 3.669"



16.8mm = 0.661"



69mm = 2.717"

AUDI Front

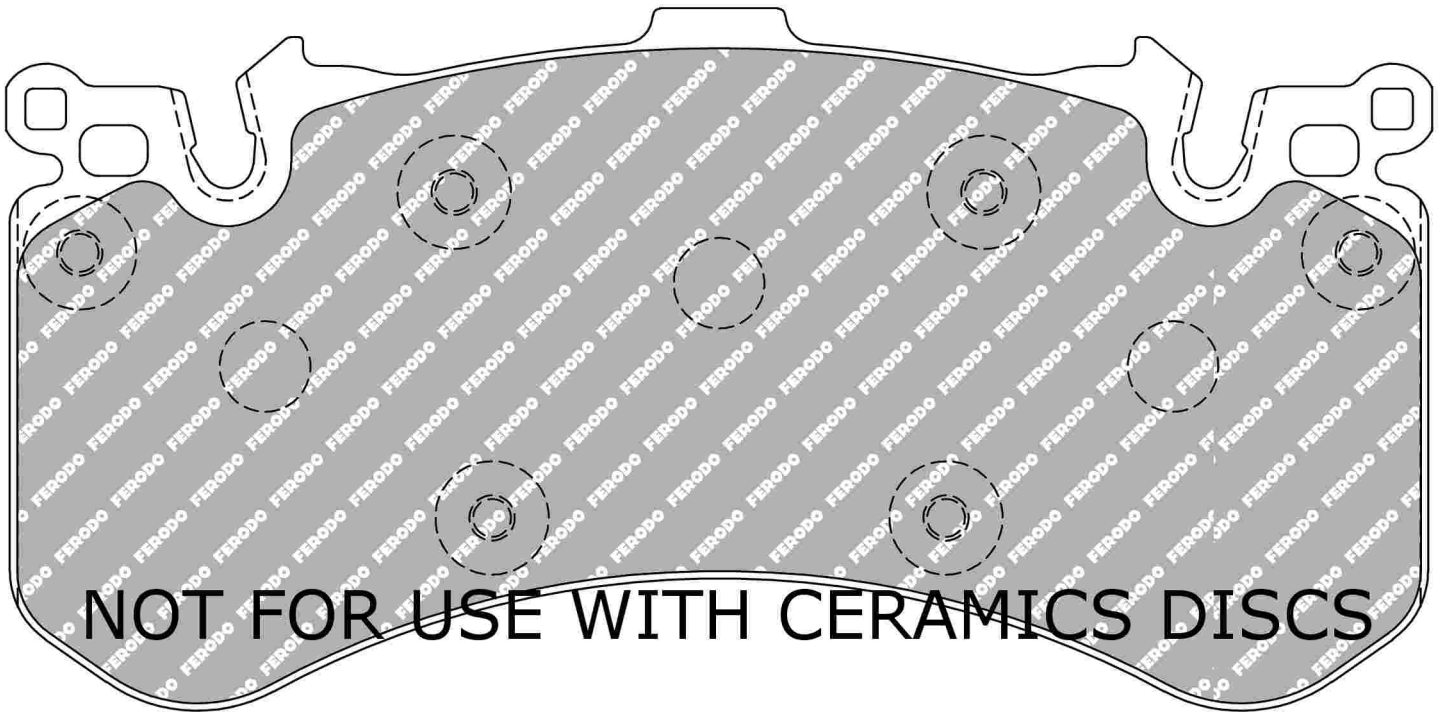

NOT FOR USE WITH CERAMICS DISCS

MATERIAL AVAILABILITY						
H	C	R	W	WB	Z	ZB
✓						

CROSS REFERENCE	
WVA	24847

FCP4489

WVA No: 24912-24913

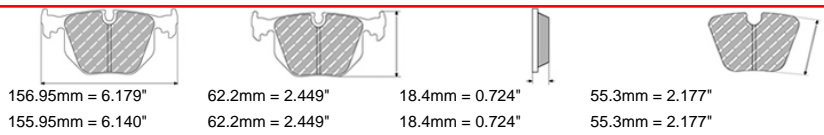

BMW Front, OPEL Front

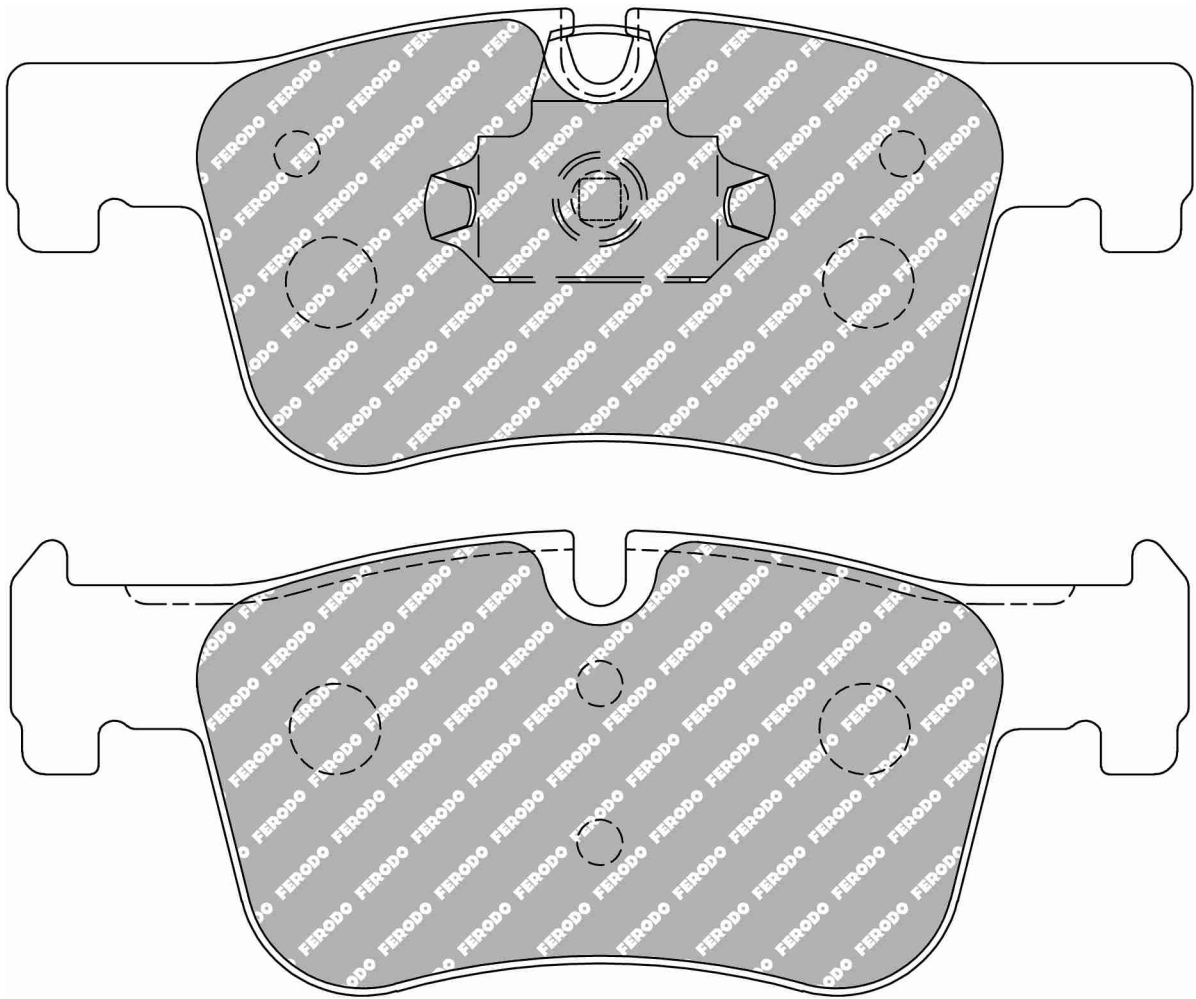

MATERIAL AVAILABILITY						
H	C	R	W	WB	Z	ZB
✓					📧	

CROSS REFERENCE	
OE BMW	34 11 6 850 568
WVA	24912-24913

- ✓ Available
- ✗ Out of Range
- 📧 In Introduction
- ⚠ Exhausting
- 📧 Make to order

FCP4587

WVA No: 25216, 25215



116.4mm = 4.583"
116.4mm = 4.583"



59.6mm = 2.346"
49.8mm = 1.961"



16.5mm = 0.650"
16.5mm = 0.650"

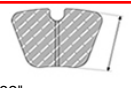

44mm = 1.732"
44mm = 1.732"

MERCEDES Rear

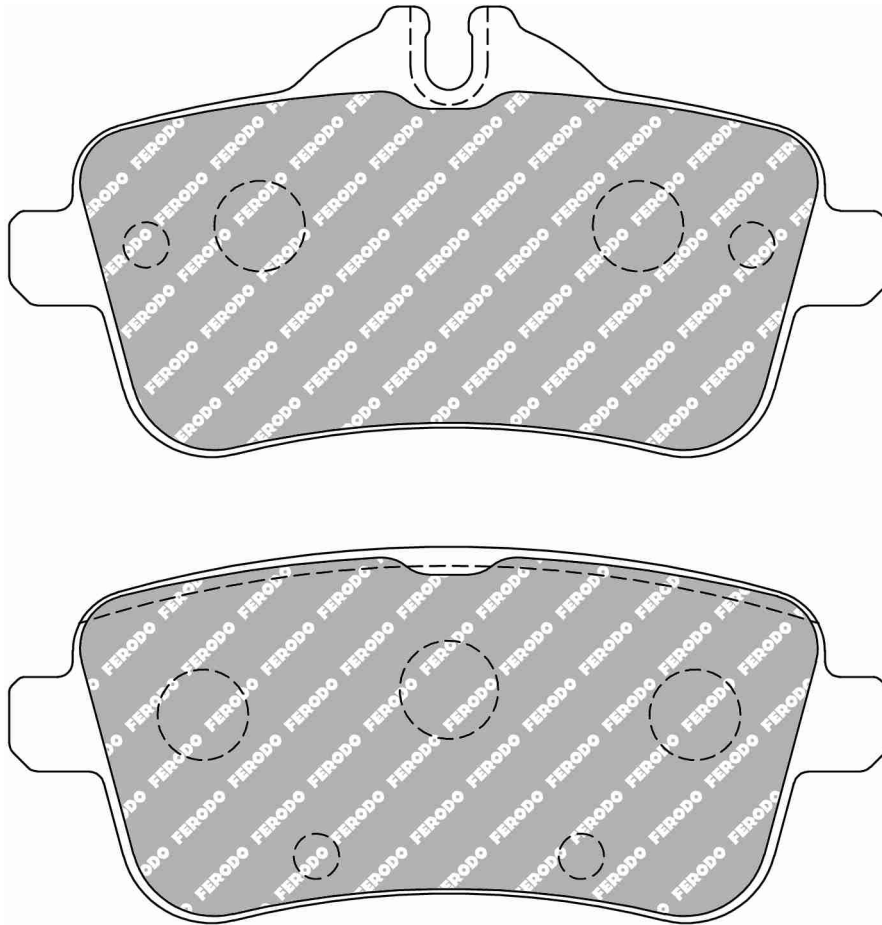

MATERIAL AVAILABILITY						
H	C	R	W	WB	Z	ZB
✓						

CROSS REFERENCE	
MINTEX	MDB3315
OE MERCEDES	0064203520
OE MERCEDES	0064206320
PAGID	T2151
PAGID	T2214
WVA	25216, 25215

FCP4611

WVA No: 25028 18,30

FMSI No: D1609

BMW Front

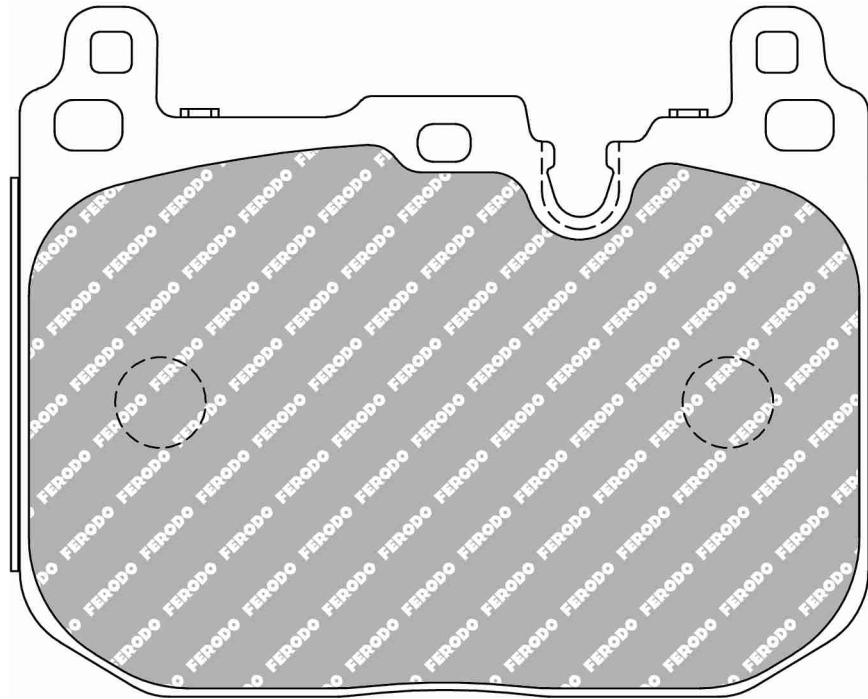
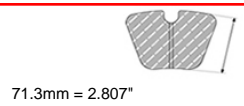
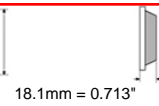
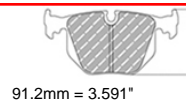
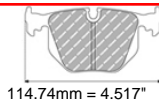

length for W & Z = 114.5 - (shim only on H compound)

ALSO AVAILABLE		
SHAPE	TH. MM	NOTES
FCP4872	15	

MATERIAL AVAILABILITY						
H	C	R	W	WB	Z	ZB
✓			✓		✓	

CROSS REFERENCE	
FMSI	D1609
OE BMW	34106799805
OE BMW	34116850850
OE BMW	34116857968
OE BMW	34116859066
OE BMW	34116859282
PAGID	T2440
WVA	25028 18,30

FCP4612

WVA No: 25134 16,70



131.8mm = 5.189"



60.5mm = 2.382"



17.5mm = 0.689"

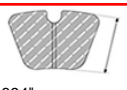

48.1mm = 1.894"

FORD Front

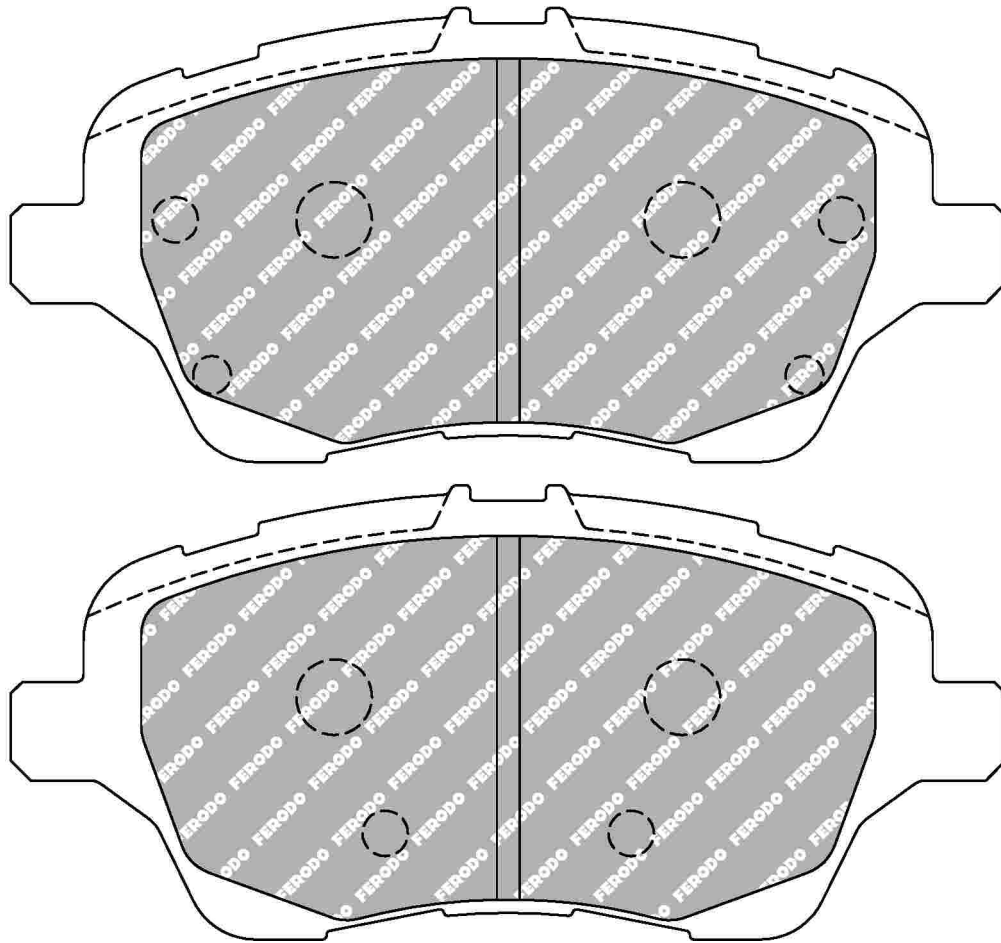

MATERIAL AVAILABILITY						
H	C	R	W	WB	Z	ZB
✓			✉			

CROSS REFERENCE	
MINTEX	MDB3322
WVA	25134 16,70

FCP4663

WVA No: 25029 17,80

FMSI No: D1656

BMW Rear

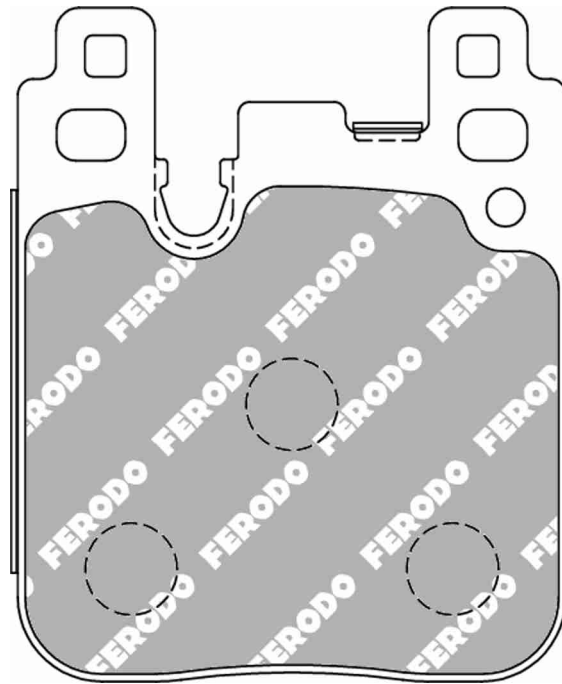
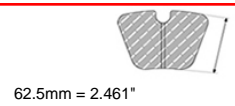
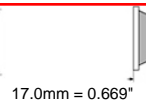
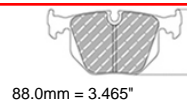
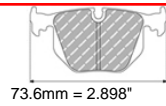

Shim available only for H material

MATERIAL AVAILABILITY

H	C	R	W	WB	Z	ZB
✓			✉		✓	

CROSS REFERENCE

FMSI	D1656
MINTEX	MDB3269
OE BMW	34216855474
PAGID	4933
PAGID	T2423
WVA	25029 17,80

✓ Available ⚠ Exhausting
 ✗ Out of Range ✉ Make to order
 📄 In Introduction

FCP4664



198.3mm = 7.807"



80.0mm = 3.150"



16.6mm = 0.654"

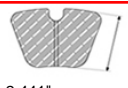

62.0mm = 2.441"

PORSCHE Front

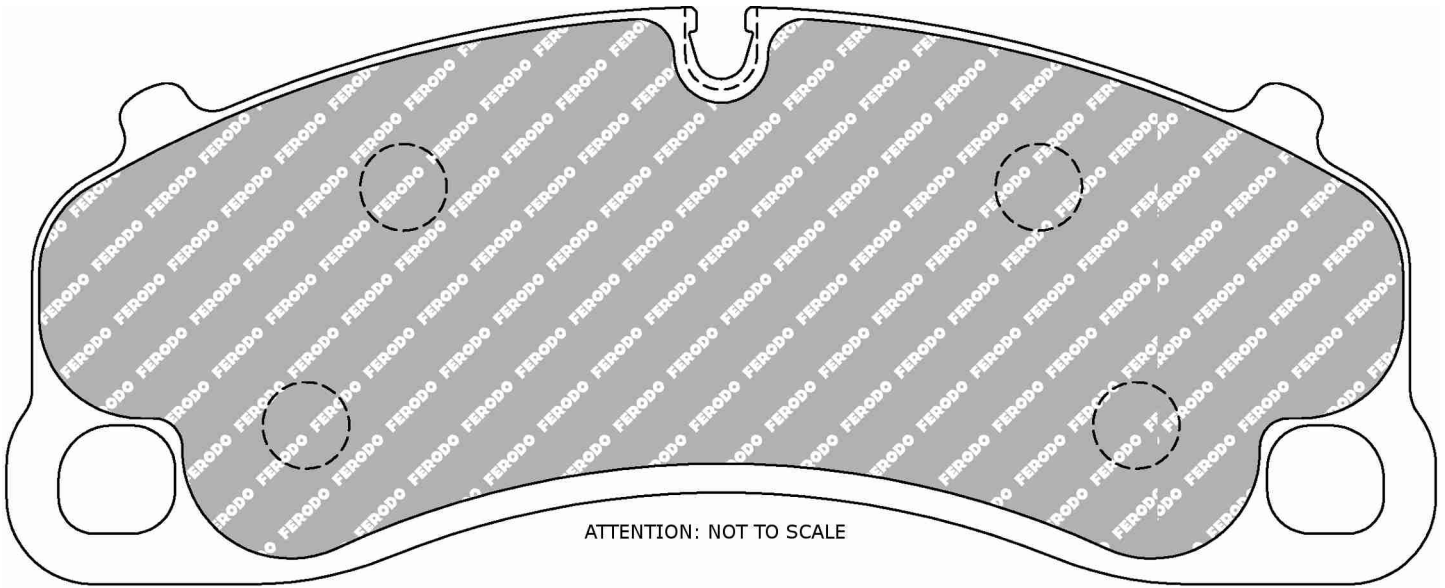

ATTENTION: NOT TO SCALE

MATERIAL AVAILABILITY

H	C	R	W	WB	Z	ZB
✓			✓		✗	✓

CROSS REFERENCE

PAGID	4924
PAGID	8235

FCP4665



187.7mm = 7.390"



75.3mm = 2.965"



17.0mm = 0.669"

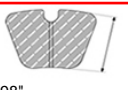

66.0mm = 2.598"

PORSCHE Rear

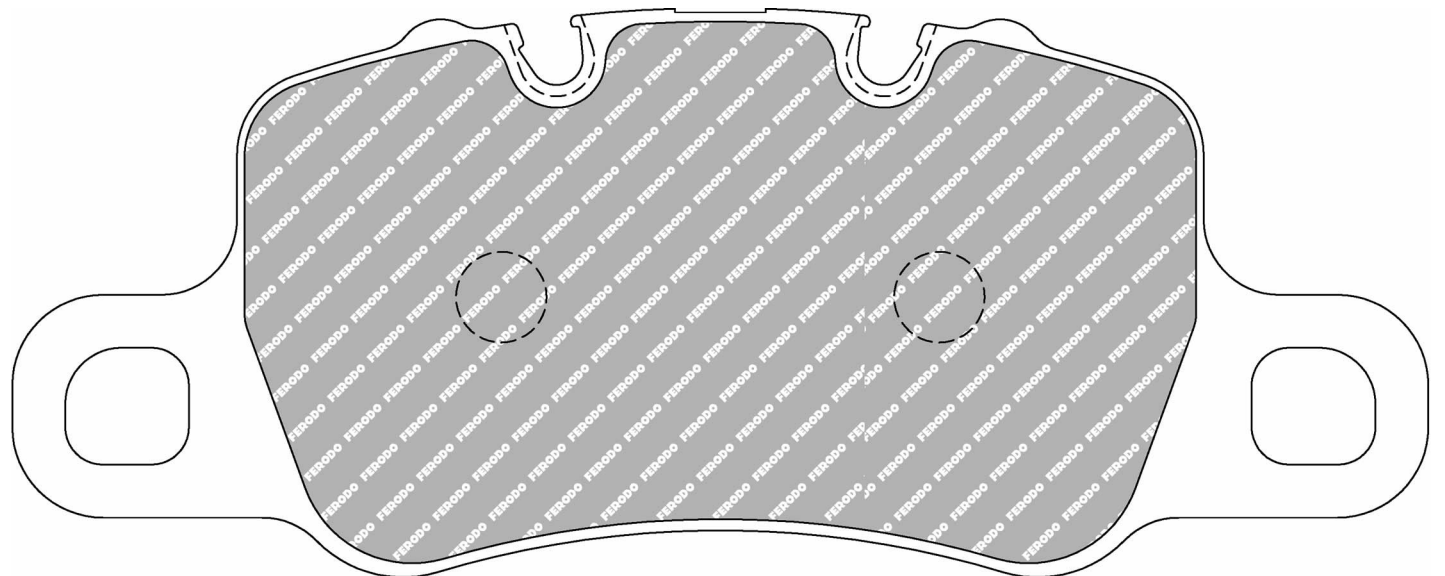

MATERIAL AVAILABILITY

H	C	R	W	WB	Z	ZB
✓			✓		✗	✓

CROSS REFERENCE

OE PORSCHE	99135294881
PAGID	4925

3222

FERODO

RACING

Updated on 17th Aug 2018

✓ Available

✗ Out of Range

ⓘ In Introduction

⚠ Exhausting

📦 Make to order

FCP4671

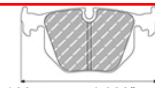

126.7mm = 4.988"



77.5mm = 3.051"



17.6mm = 0.693"



57.7mm = 2.272"

FMSI No: D1576

HYUNDAI Front

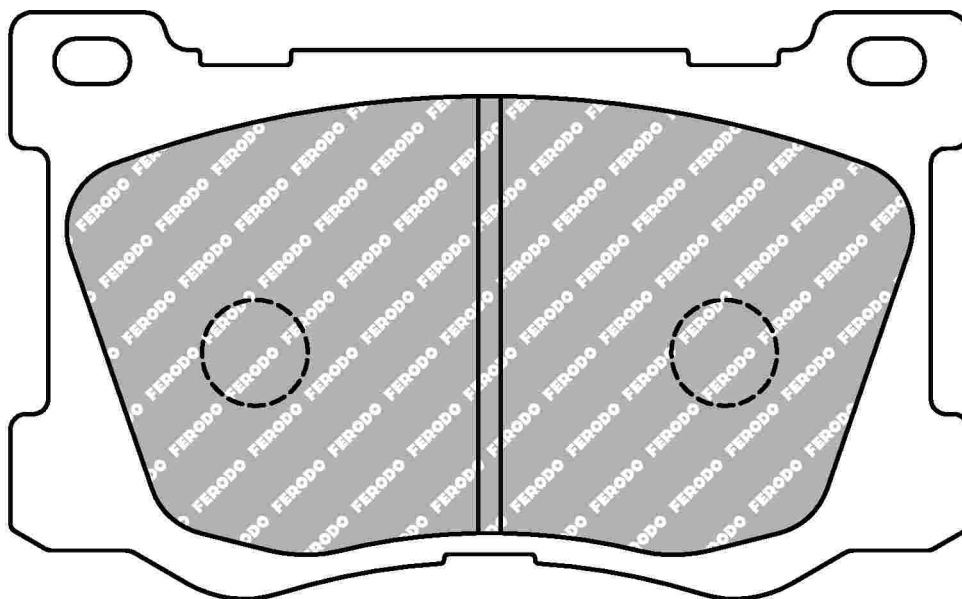

MATERIAL AVAILABILITY						
H	C	R	W	WB	Z	ZB
✓						

CROSS REFERENCE	
EBC	DP21882
FMSI	D1576

- ✓ Available
- ✗ Out of Range
- ⓘ In Introduction
- ⚠ Exhausting
- 📦 Make to order

FCP4697

WVA No: 25008 - 25010



123.2mm = 4.850"
123.2mm = 4.850"



61.2mm = 2.409"
56.2mm = 2.213"



16.6mm = 0.654"
16.6mm = 0.654"

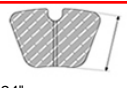

51.4mm = 2.024"
51.4mm = 2.024"

AUDI Rear, SKODA Rear, VOLKSWAGEN Front / Rear

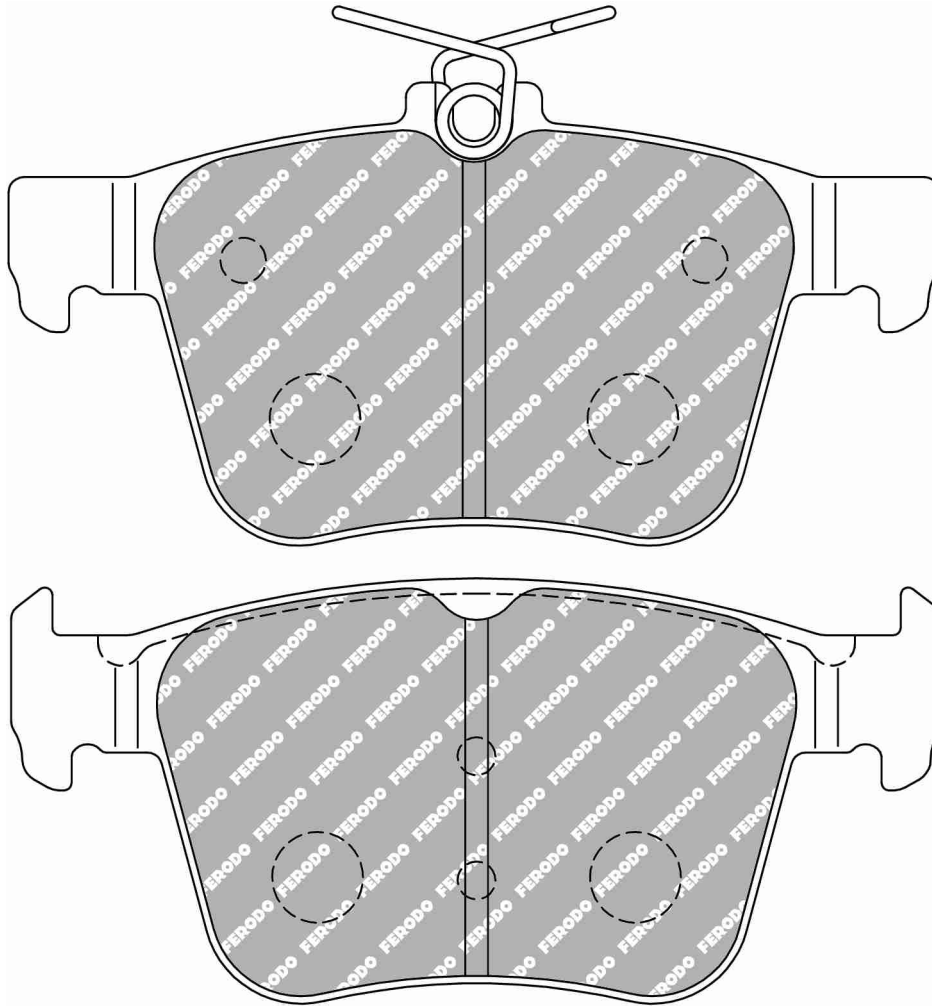

MATERIAL AVAILABILITY						
H	C	R	W	WB	Z	ZB
✓						

CROSS REFERENCE	
BREMBO	P85124
MINTEX	MDB3100
MINTEX	MDB3101
PAGID	1976
PAGID	1977
WVA	25008 - 25010

FCP4711



189.8mm = 7.472"

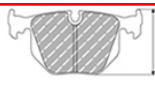

85.0mm = 3.346"



15.8mm = 0.622"



65.0mm = 2.559"

FORD Front

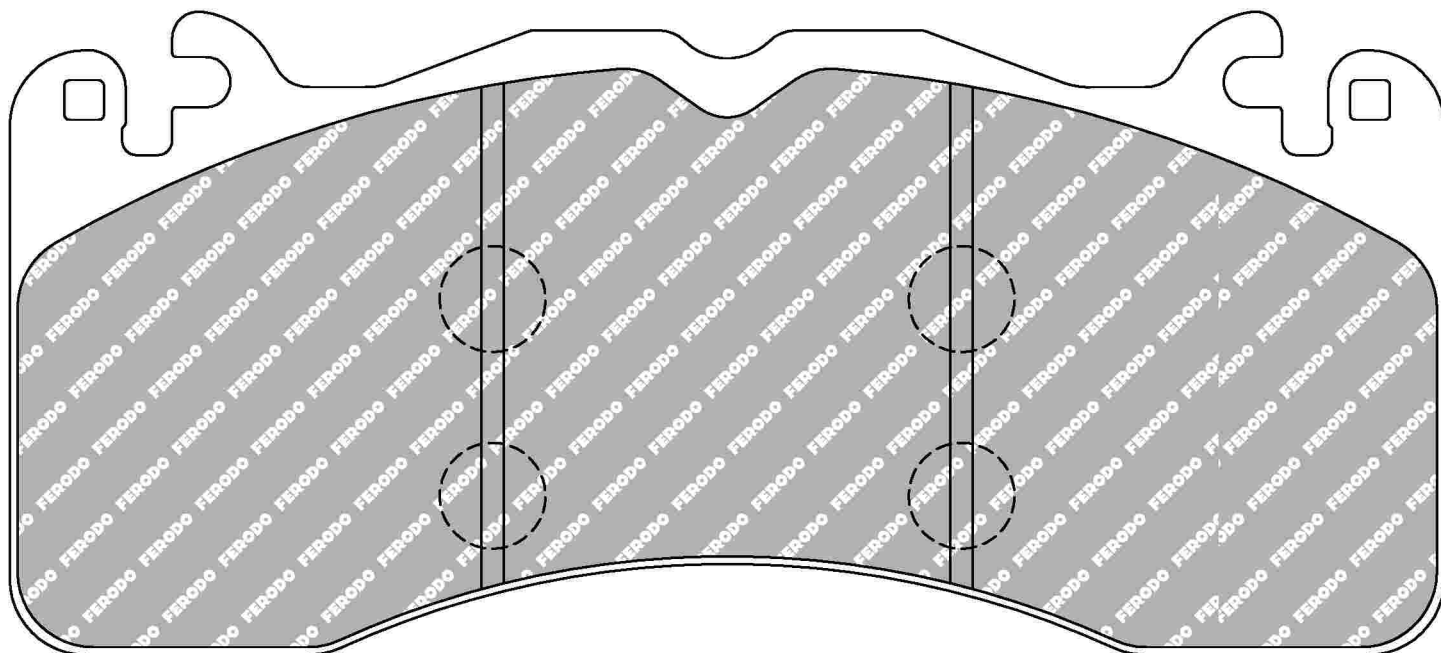

MATERIAL AVAILABILITY

H	C	R	W	WB	Z	ZB
✓			📧		📧	

CROSS REFERENCE

PAGID	8203
-------	------

- ✓ Available
- ✗ Out of Range
- 📧 In Introduction
- ⚠ Exhausting
- 📧 Make to order

FCP4712

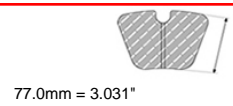
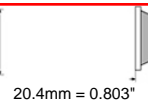
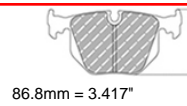
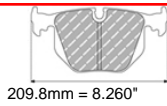

BMW Front

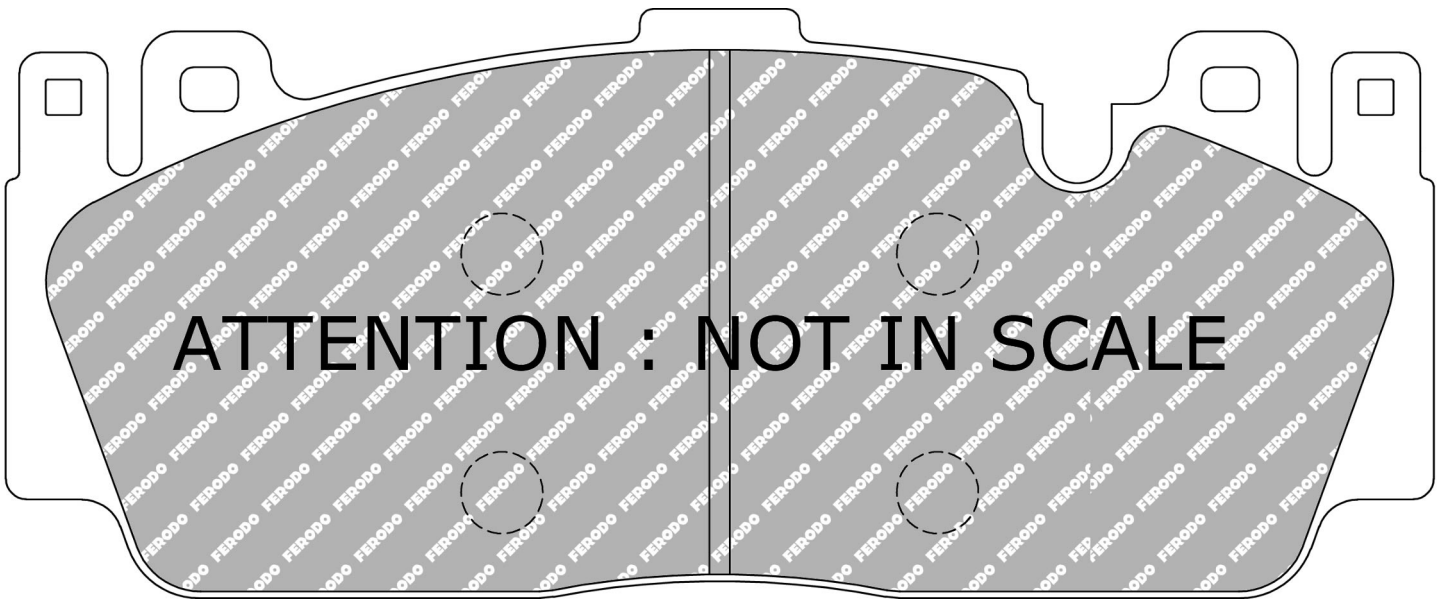

Back-plate design does not allow wear indicator fitment

MATERIAL AVAILABILITY						
H	C	R	W	WB	Z	ZB
✓					✉	

CROSS REFERENCE	
OE BMW	34112284369
PAGID	4934

FCP4713

WVA No: 24554, 25691



187.7mm = 7.390"



70.6mm = 2.780"



16mm = 0.630"

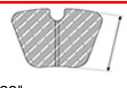

59mm = 2.323"

PORSCHE Rear

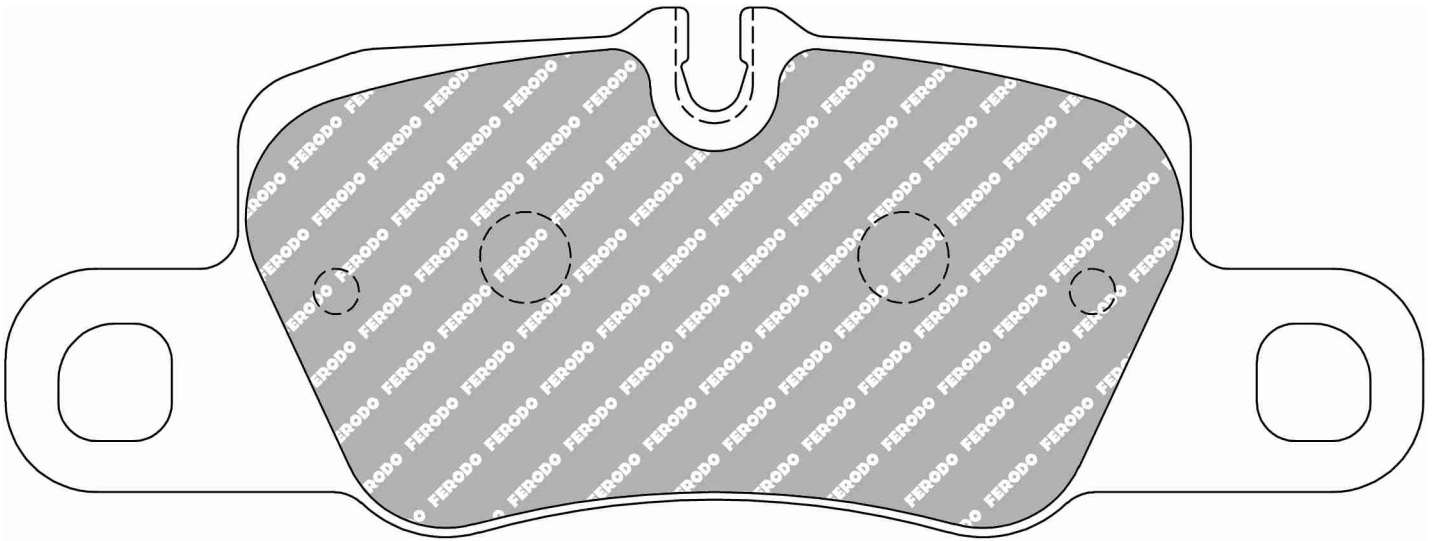

MATERIAL AVAILABILITY						
H	C	R	W	WB	Z	ZB
✓			⬇️			

CROSS REFERENCE	
MINTEX	MDB2975
OE PORSCHE	97035194905
OE PORSCHE	97035294902
OE PORSCHE	97035294904
OE PORSCHE	97035294905
OE PORSCHE	99135294803
PAGID	4909
PAGID	T1785
PAGID	T2309
WVA	24554, 25691

✓ Available ⚠️ Exhausting
 ✗ Out of Range 📦 Make to order
 ⬇️ In Introduction

FCP4805

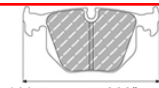

199.7mm = 7.862"



74.6mm = 2.937"



18.5mm = 0.728"



59.8mm = 2.354"

PORSCHE Front

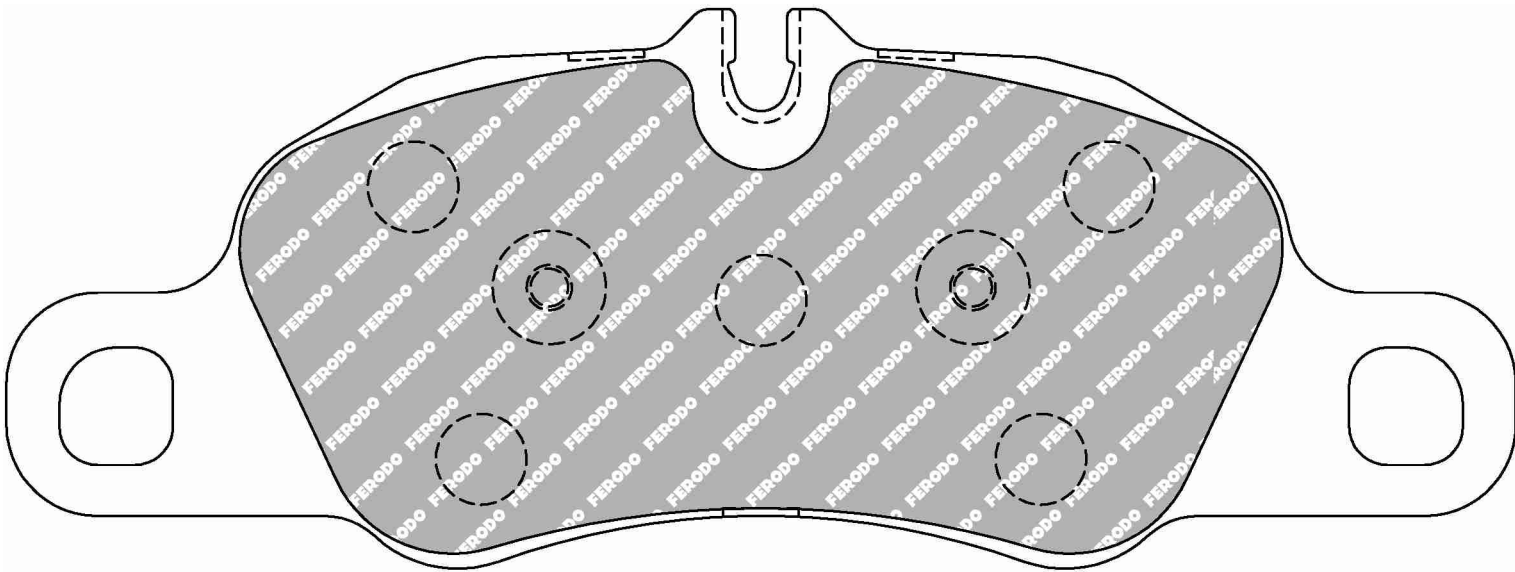

MATERIAL AVAILABILITY						
H	C	R	W	WB	Z	ZB
✓			✉		✉	

CROSS REFERENCE	
PAGID	8074
PAGID	T1753

FCP4806

WVA No: 25219



154.6mm = 6.087"



92.6mm = 3.646"



16.7mm = 0.657"



68.7mm = 2.705"

MERCEDES Front

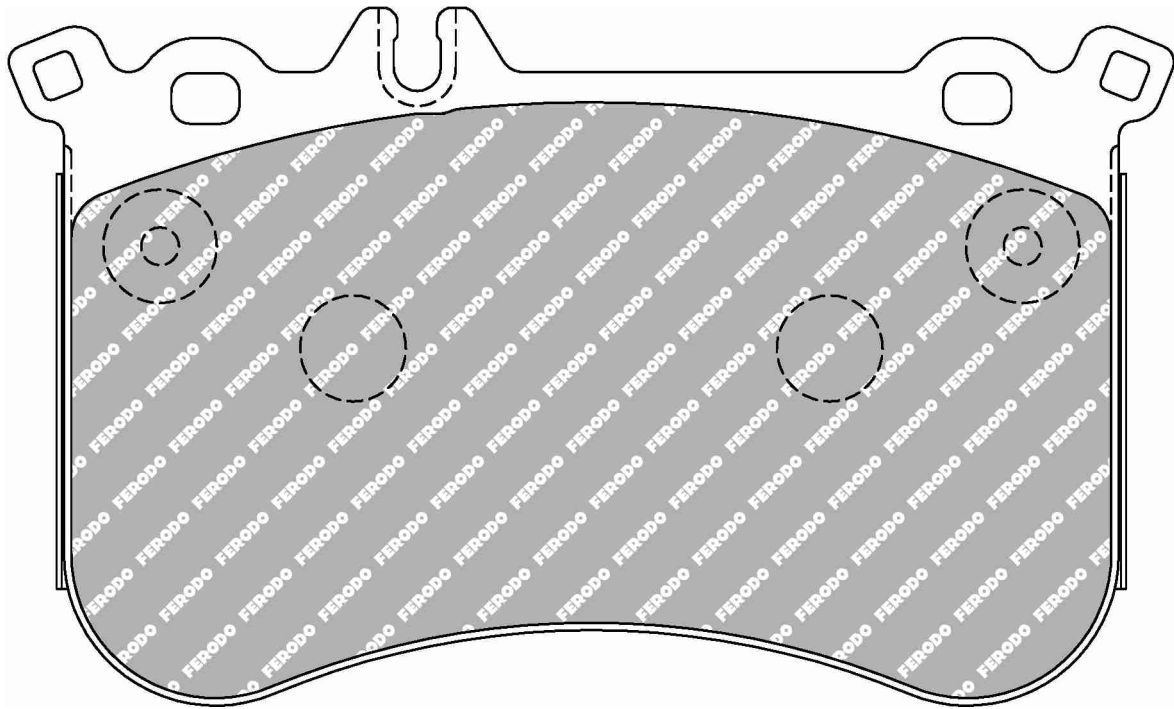

MATERIAL AVAILABILITY

H	C	R	W	WB	Z	ZB
✓		✉				

CROSS REFERENCE

PAGID	8188
PAGID	T2102
PAGID	T2419
WVA	25219

✓ Available ⚠ Exhausting
 ✗ Out of Range ✉ Make to order
 ⓘ In Introduction

FCP4816



155.3mm = 6.114"
155.3mm = 6.114"



56.6mm = 2.228"
55.6mm = 2.189"



16.4mm = 0.646"
16.4mm = 0.646"



49mm = 1.929"
49mm = 1.929"

FORD Front

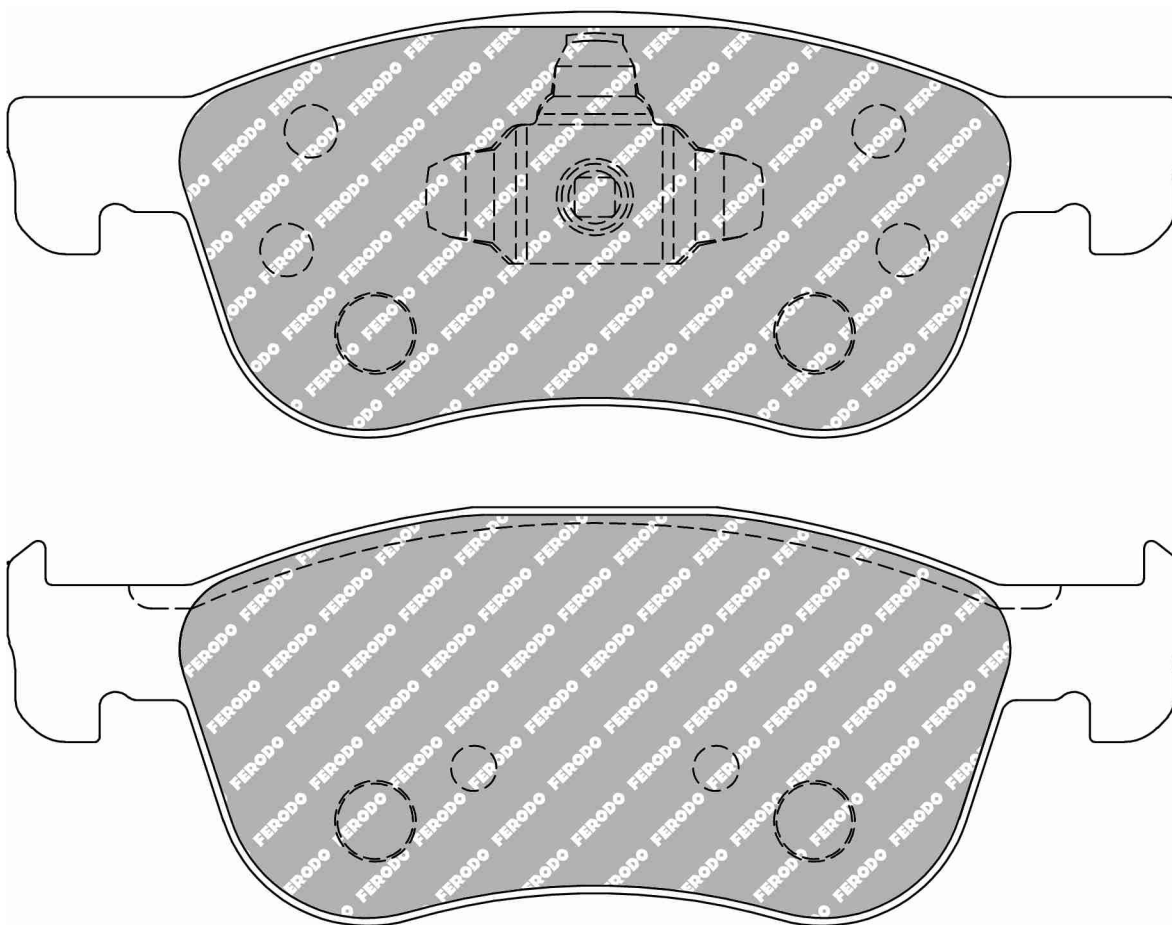

MATERIAL AVAILABILITY						
H	C	R	W	WB	Z	ZB
✓						

FCP4821

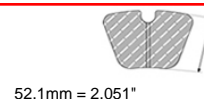
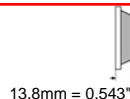

ABARTH Front, FIAT Front, MAZDA Front

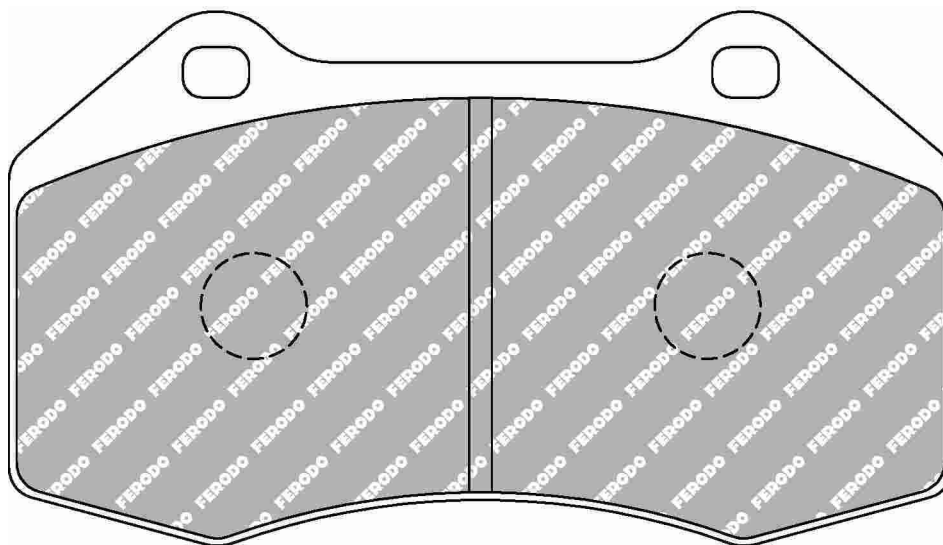

ALSO AVAILABLE		
SHAPE	TH. MM	NOTES
FCP1667	15.5	

MATERIAL AVAILABILITY						
H	C	R	W	WB	Z	ZB

- Available
- Out of Range
- In Introduction
- Exhausting
- Make to order

FCP4830

WVA No: 22569-22570-22571

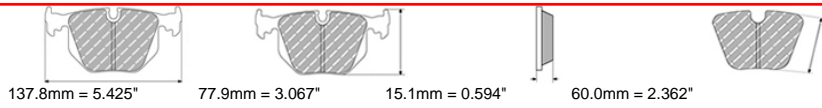

FORD Front

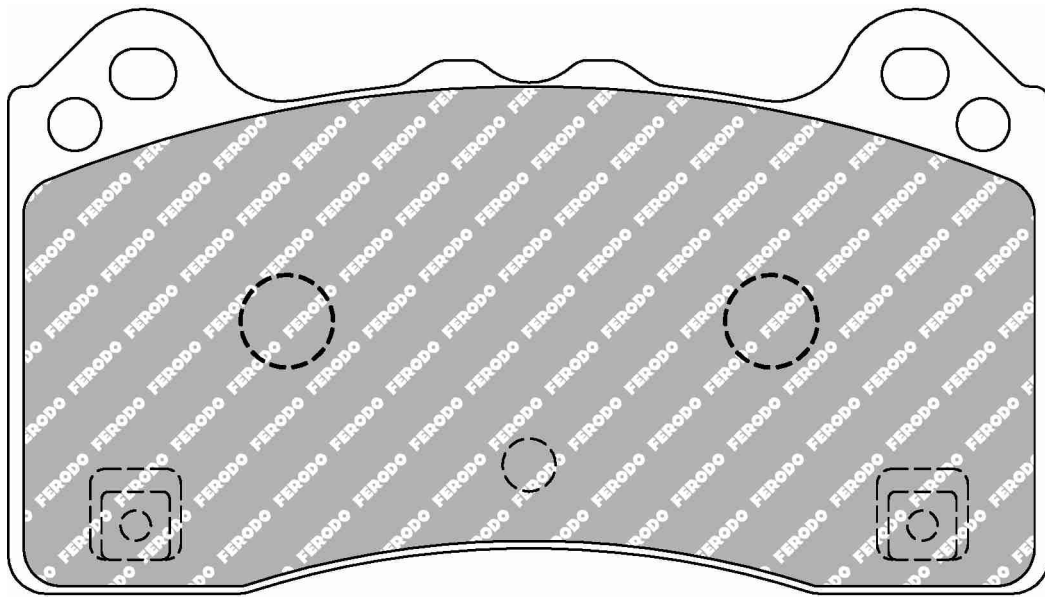

MATERIAL AVAILABILITY						
H	C	R	W	WB	Z	ZB
✓			✉		✉	

CROSS REFERENCE	
OE FORD	2003984
WVA	22569-22570-22571

FCP4835

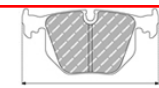

189.2mm = 7.449"

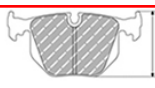

92.7mm = 3.650"



16.3mm = 0.642"

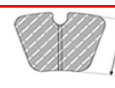

77.5mm = 3.051"

FORD Front

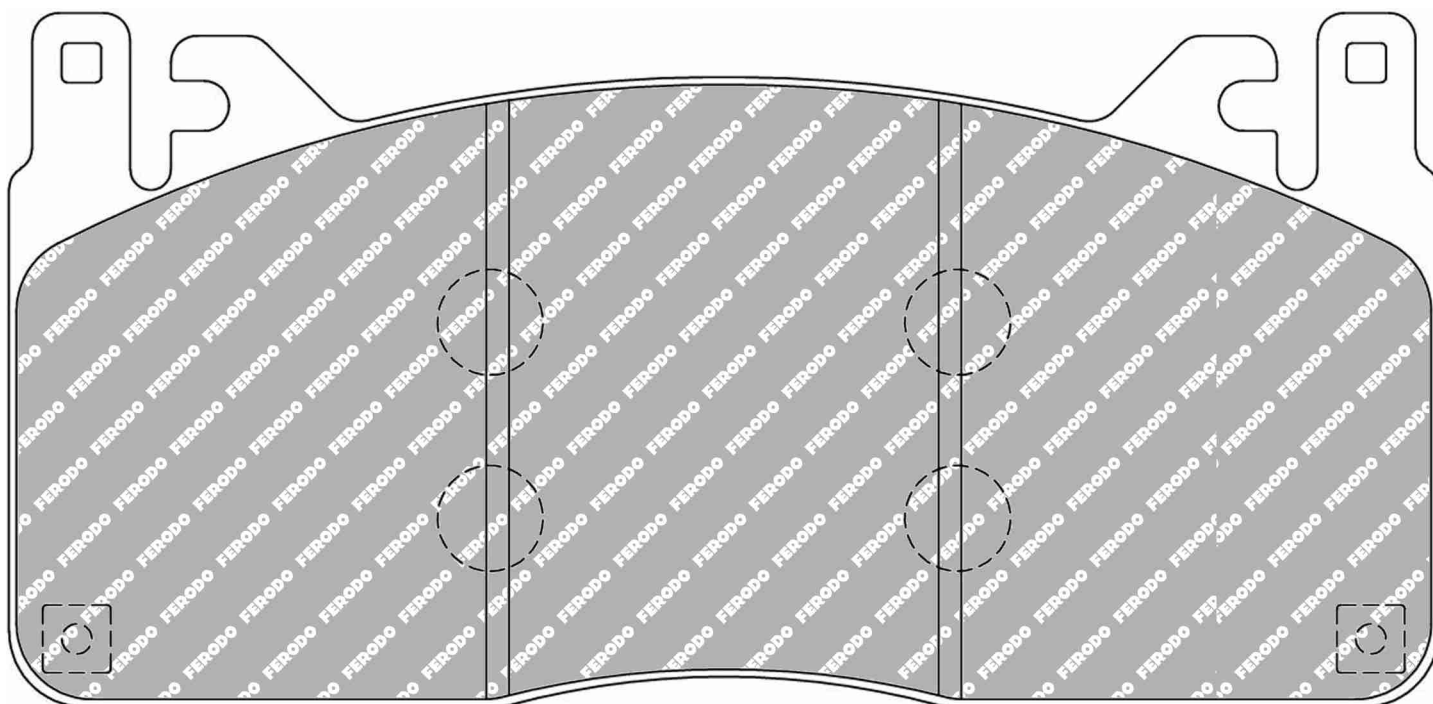

MATERIAL AVAILABILITY

H	C	R	W	WB	Z	ZB
✓					✓	

- ✓ Available
- ✗ Out of Range
- ⚠ Exhausting
- 📦 Make to order
- 📅 In Introduction

FCP4872

WVA No: 22344

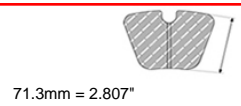
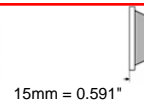
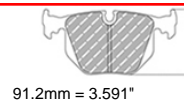

MINI Front

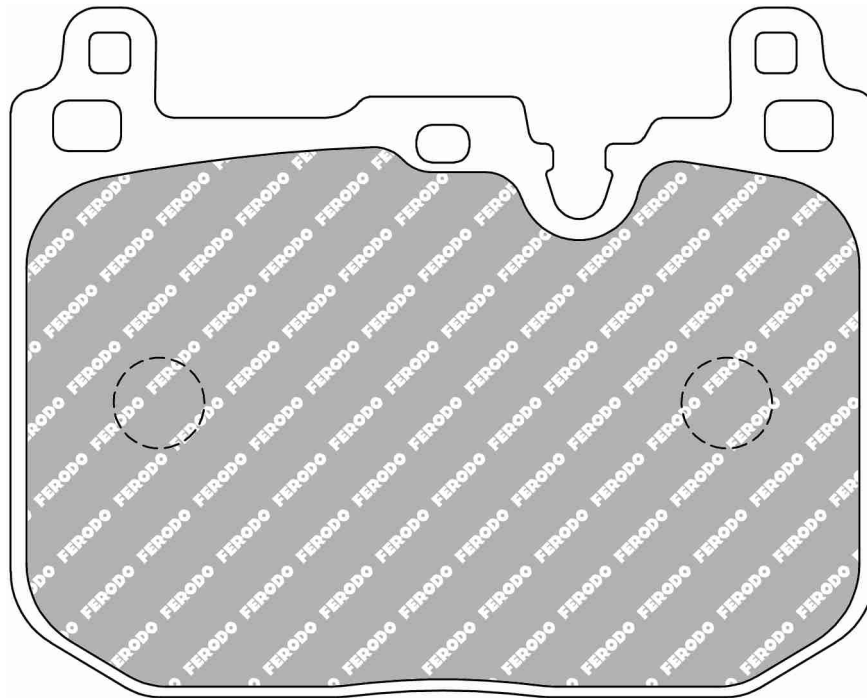

Wear indicator lead cannot be fitted; Replacement piston rubber caps not provided

ALSO AVAILABLE

SHAPE	TH. MM	NOTES
FCP4611	18.1	

CROSS REFERENCE

OE BMW	34106860020
WVA	22344

MATERIAL AVAILABILITY

H	C	R	W	WB	Z	ZB
✓			✉		✉	

3234

FCP4873

WVA No: 22271



122.65mm = 4.829"



53.9mm = 2.122"



14.6mm = 0.575"



46.5mm = 1.831"

MAZDA Front

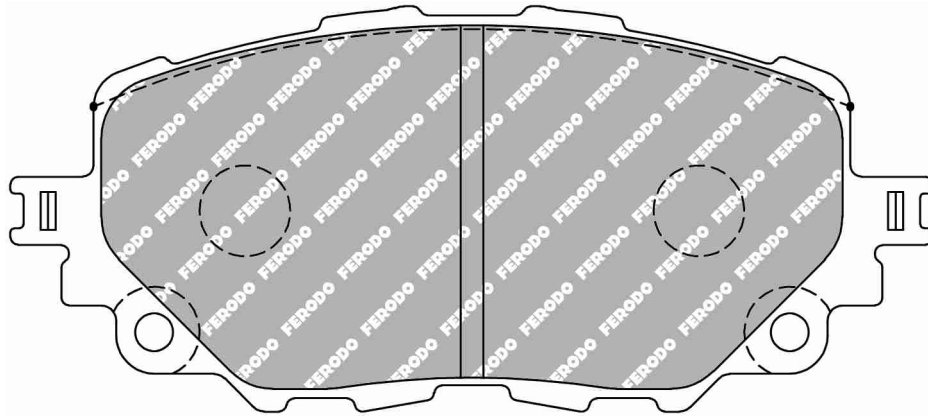

MATERIAL AVAILABILITY						
H	C	R	W	WB	Z	ZB
✓						

CROSS REFERENCE	
WVA	22271

FCP4955

WVA No: 25003



198.7mm = 7.823"



75.8mm = 2.984"



17.3mm = 0.681"



56.5mm = 2.224"

PORSCHE Front

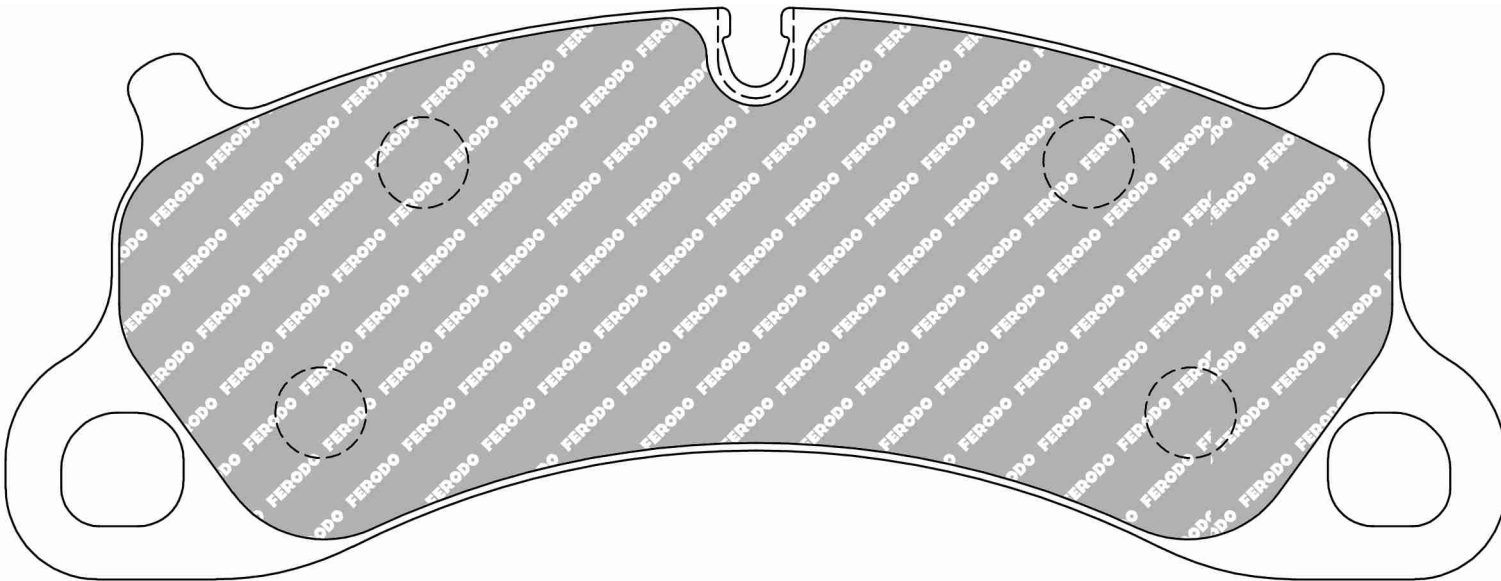

The H (DS2500) version is capable of taking an electronic wear indicator plug. The W (DS1.11) version cannot take a plug

MATERIAL AVAILABILITY						
H	C	R	W	WB	Z	ZB
✓			✓			

CROSS REFERENCE	
MINTEX	MDB3243
OE PORSCHE	99135194902
PAGID	4922
PAGID	T2150
WVA	25003

- ✓ Available
- ✗ Out of Range
- ⓘ In Introduction
- ⚠ Exhausting
- 📄 Make to order

FCP4972



113.8mm = 4.480"



59mm = 2.323"



14.5mm = 0.571"



46.1mm = 1.815"

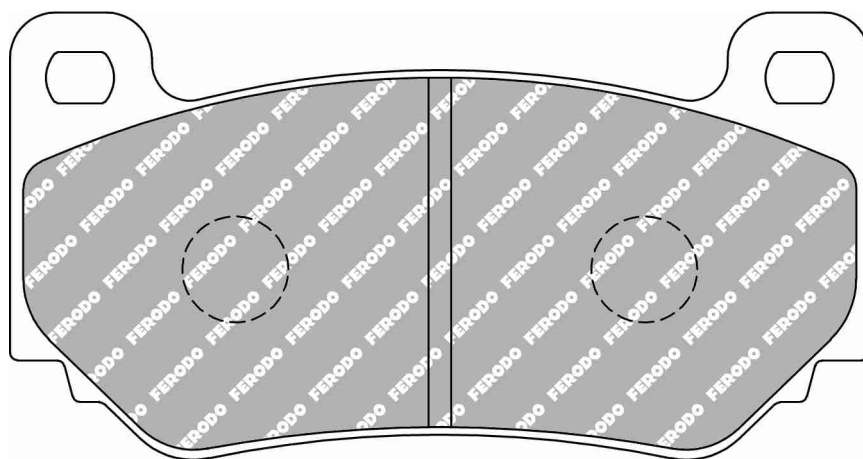

ALSO AVAILABLE

SHAPE	TH. MM	NOTES
FRP3085	16.2	

CROSS REFERENCE

PAGID	8076
-------	------

MATERIAL AVAILABILITY

H	C	R	W	WB	Z	ZB
✓						

FCP5030



189.9mm = 7.476"



96.6mm = 3.803"



16.1mm = 0.634"

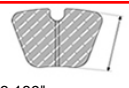

81mm = 3.189"

FMSI No: D1395

CHEVROLET Front

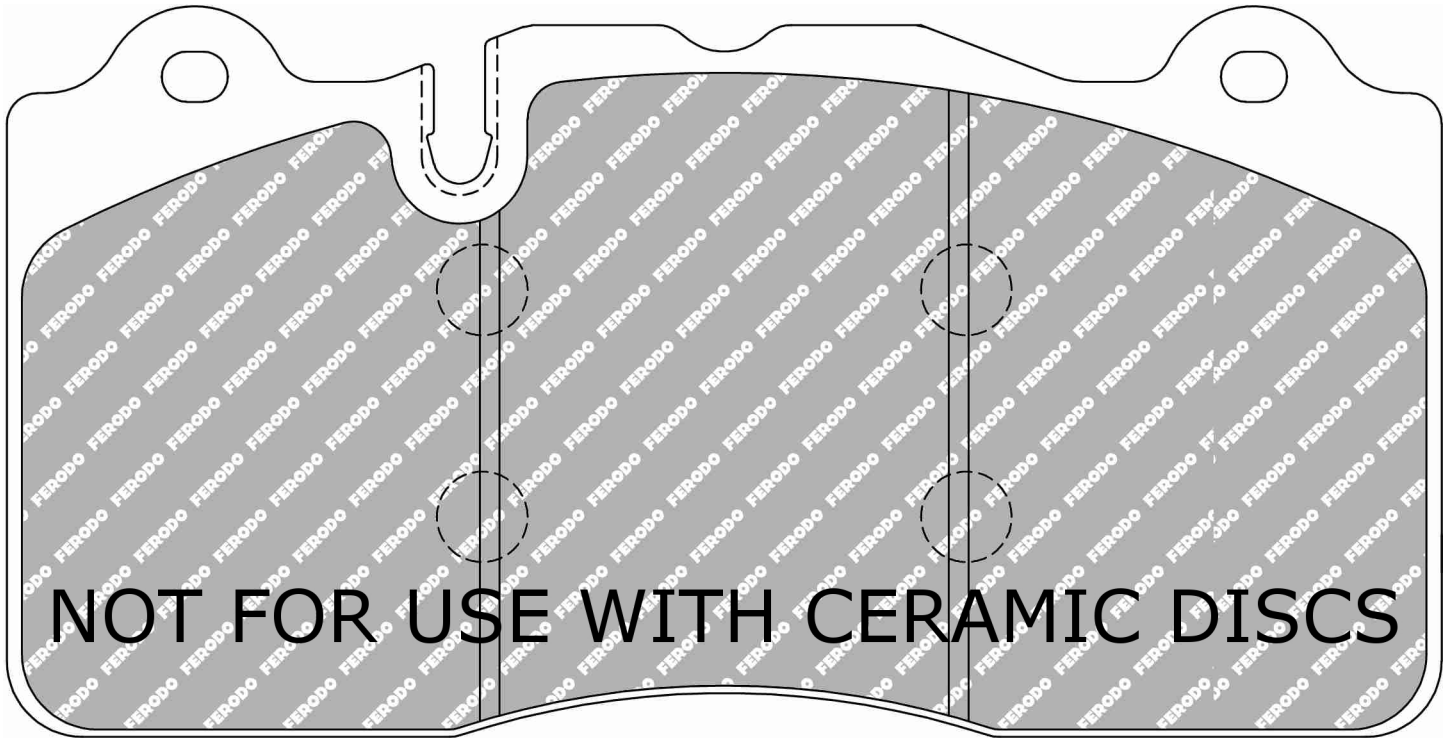

Not for use with ceramic discs

MATERIAL AVAILABILITY

H	C	R	W	WB	Z	ZB

CROSS REFERENCE

FMSI	D1395
HAWK	HB631

- Available
- Exhausting
- Out of Range
- Make to order
- In Introduction

FRP101

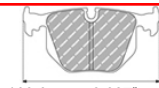

100.0mm = 3.937"



53.0mm = 2.087"



16.0mm = 0.630"



49.3mm = 1.941"

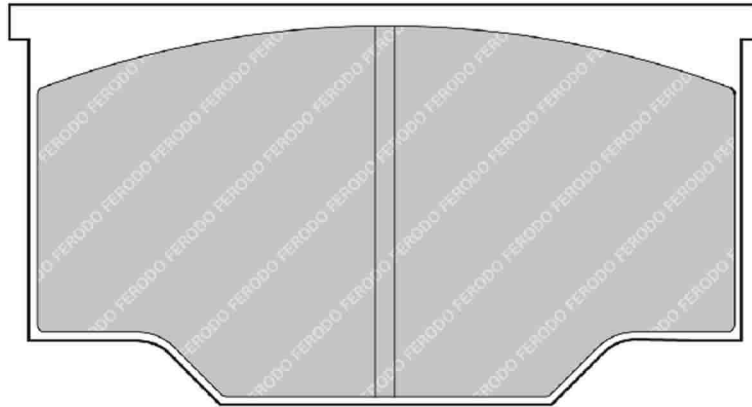

MATERIAL AVAILABILITY						
H	C	R	W	WB	Z	ZB
		✓			✉	

CROSS REFERENCE	
ALCON	3435
PAGID	1192
PFC	7710

FRP201



113.5mm = 4.469"



52.0mm = 2.047"



15.7mm = 0.618"



48.0mm = 1.890"

CATERHAM Front

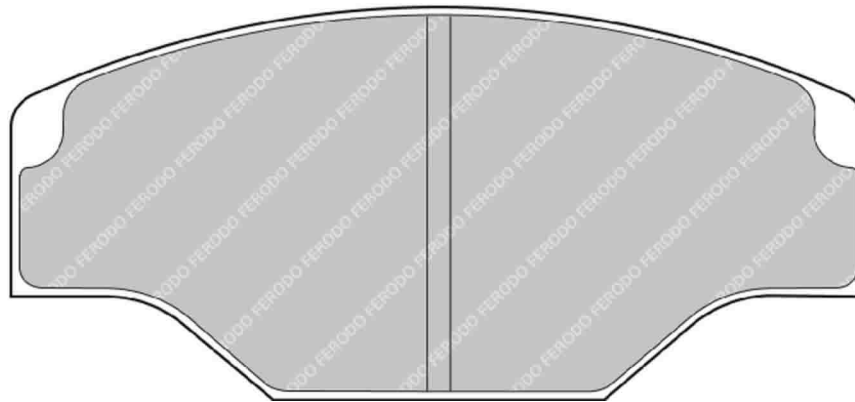

MATERIAL AVAILABILITY						
H	C	R	W	WB	Z	ZB
✓	✉	✓	✓		✓	

CROSS REFERENCE	
ALCON	PNF0084X264.4
ALCON	PNF4463X554
ALCON	PNF4463X554.4
ALCON	PNF4463X581.4
AP RACING	CP2340D51
PAGID	1265

FRP202



81.9mm = 3.224"



58.0mm = 2.283"



15.8mm = 0.622"

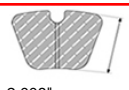

51.0mm = 2.008"

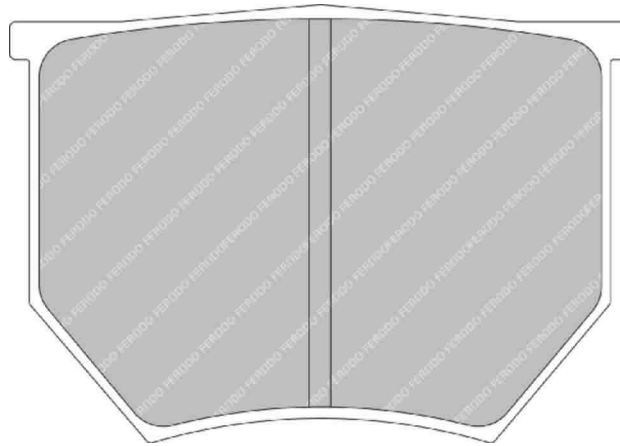

MATERIAL AVAILABILITY						
H	C	R	W	WB	Z	ZB
✓	✓	✓				

CROSS REFERENCE	
AP RACING	CP2373
AP RACING	CP2382
AP RACING	CP2383
AP RACING	CP2384
PAGID	8040

FRP203



127.0mm = 5.000"



56.0mm = 2.205"



16.5mm = 0.650"

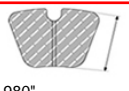

50.3mm = 1.980"

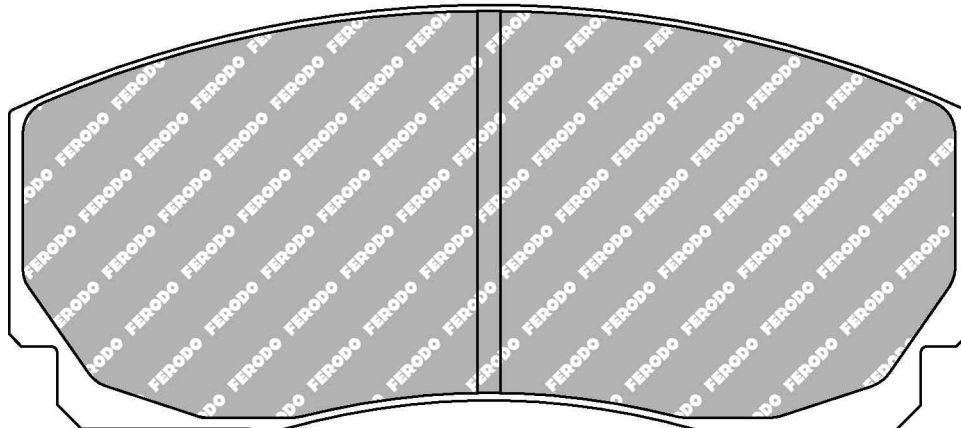

MATERIAL AVAILABILITY						
H	C	R	W	WB	Z	ZB
✓		✓			✓	

CROSS REFERENCE	
AP RACING	CP2270D50
PAGID	1269

FRP212

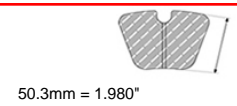
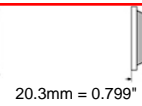
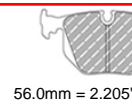
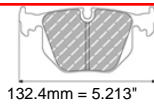

CHEVROLET Rear, OPEL Front

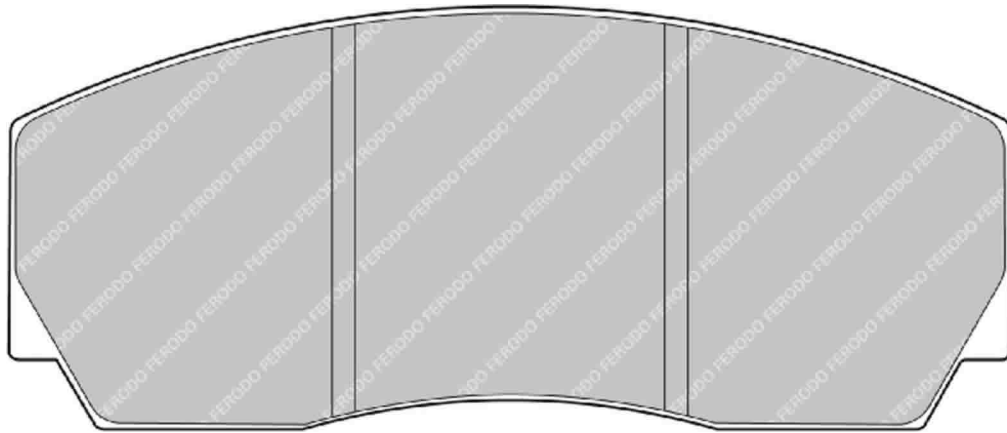

ALSO AVAILABLE		
SHAPE	TH. MM	NOTES
FRP216	17	

CROSS REFERENCE	
AP RACING	CP2279D50
PAGID	1270
PFC	7767
PFC	7767.XX.20

MATERIAL AVAILABILITY						
H	C	R	W	WB	Z	ZB
✓		✓	✓		✓	

FRP216

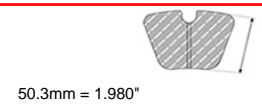
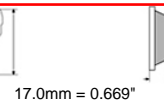
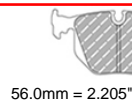
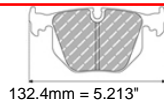

AC Front, ASTON MARTIN Front, RENAULT Front, SUBARU Front

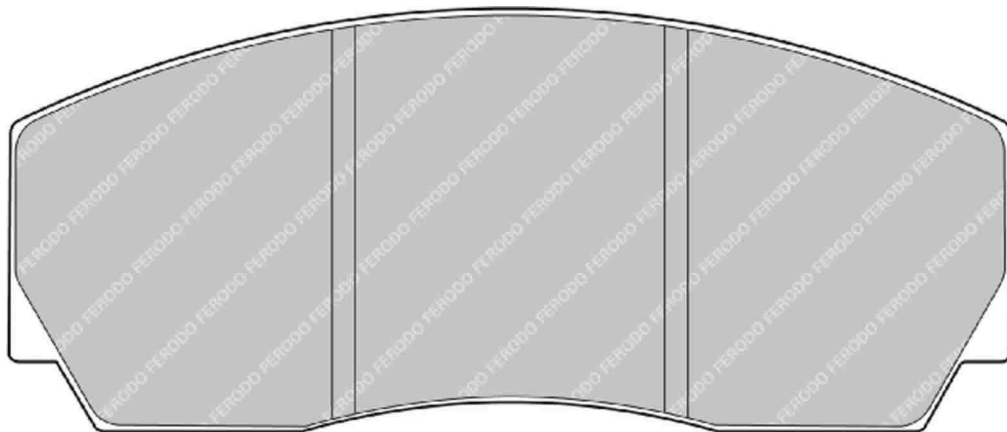

ALSO AVAILABLE		
SHAPE	TH. MM	NOTES
FRP212	20.3	

CROSS REFERENCE	
ALCON	PNF0084X245.4
ALCON	PNF0084X331
ALCON	PNF0084X331.4
AP RACING	CP3215D50
BREMBO	7767.XX.17
PAGID	1361

MATERIAL AVAILABILITY						
H	C	R	W	WB	Z	ZB
✓	✗	✓	✓		✓	

FRP217



130.2mm = 5.126"

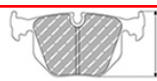

76.0mm = 2.992"



25.0mm = 0.984"

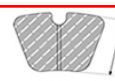

54.0mm = 2.126"

ASTON MARTIN Front

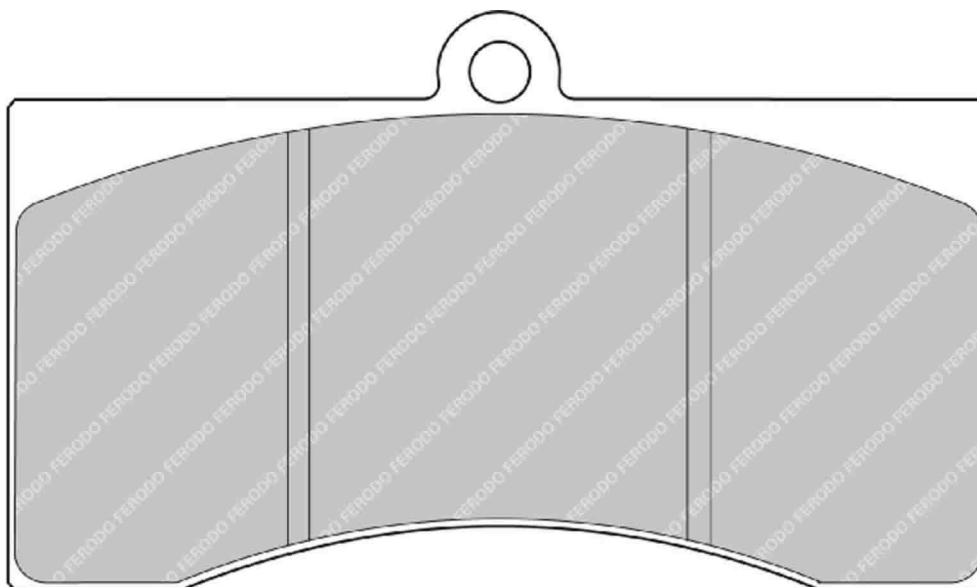

MATERIAL AVAILABILITY						
H	C	R	W	WB	Z	ZB
		✓	✗		✓	

CROSS REFERENCE	
AP RACING	CP3714D54
PAGID	1267
PFC	7714

FRP218



113.6mm = 4.472"

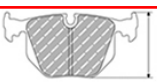

47.0mm = 1.850"



16.0mm = 0.630"

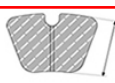

40.6mm = 1.598"

CITROEN Front

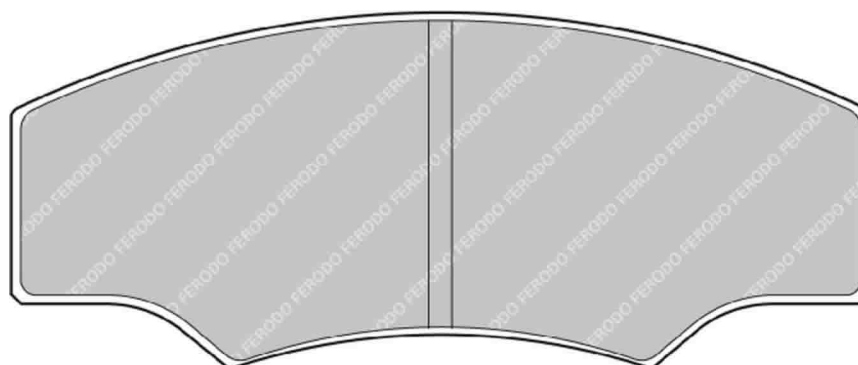

MATERIAL AVAILABILITY						
H	C	R	W	WB	Z	ZB
✓	✓	✓	✓			

CROSS REFERENCE	
ALCON	PNF4463X551
ALCON	PNF4463X551.4
AP RACING	CP2340D43
PAGID	1749
PFC	7740

✓ Available ⚠ Exhausting
 ✗ Out of Range 📦 Make to order
 📌 In Introduction

FRP219

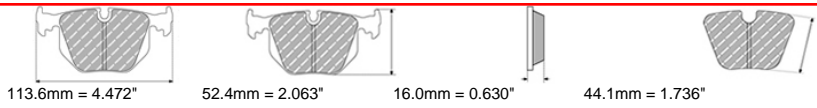

PEUGEOT Front, SUBARU Rear

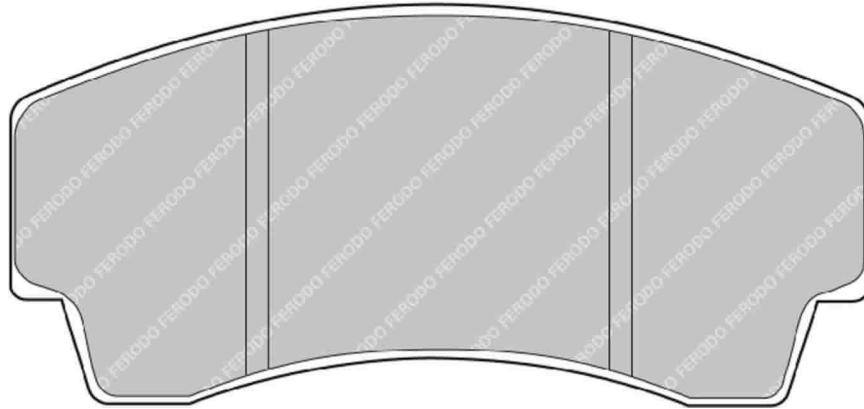

MATERIAL AVAILABILITY						
H	C	R	W	WB	Z	ZB
✓	✓	✓	✓		✓	

CROSS REFERENCE	
ALCON	PNF4463X529
ALCON	PNF4463X529.4
ALCON	PNF4463X572
AP RACING	CP3345D44
PAGID	2127
PFC	7745

FRP302

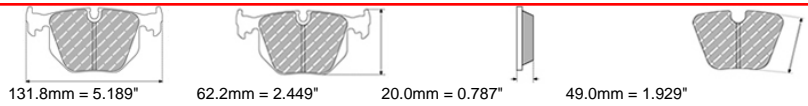

CITROEN Front, PORSCHE Rear

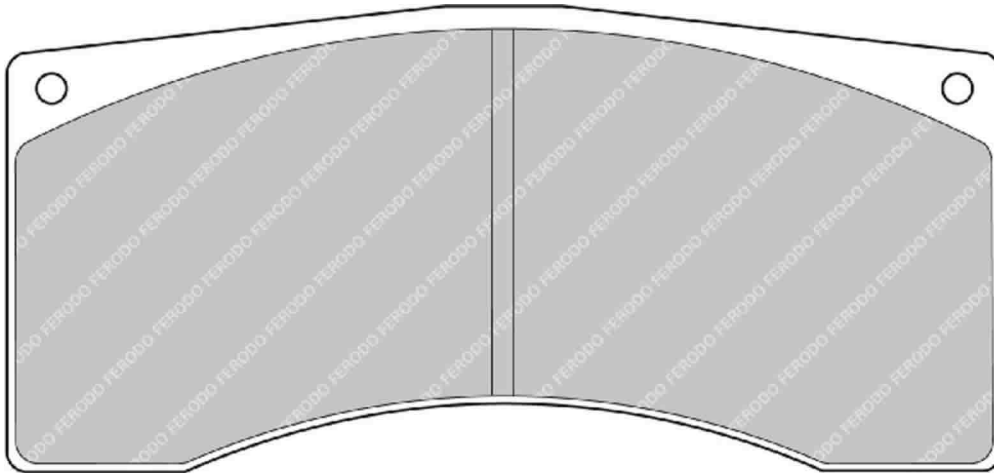

ALSO AVAILABLE		
SHAPE	TH. MM	NOTES
FRP1077	16	
FRP1078	25	
FRP3007	18	

CROSS REFERENCE	
ALCON	PNF4441X728
ALCON	PNF4441X728.4
ALCON	PNF4441X754
ALCON	PNF4441X754.4
ALCON	PNF4441X757.4
BREMBO	07.5139.6
BREMBO	07.5139.65
BREMBO	07.5139.69
PAGID	1607
PFC	7700.XX.20

MATERIAL AVAILABILITY						
H	C	R	W	WB	Z	ZB
✓	✗	✓	✗		✗	✓

FRP308

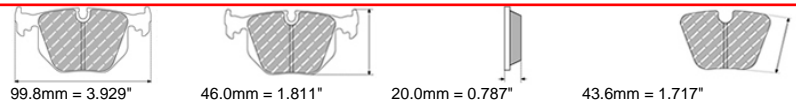

mitsubishi Rear

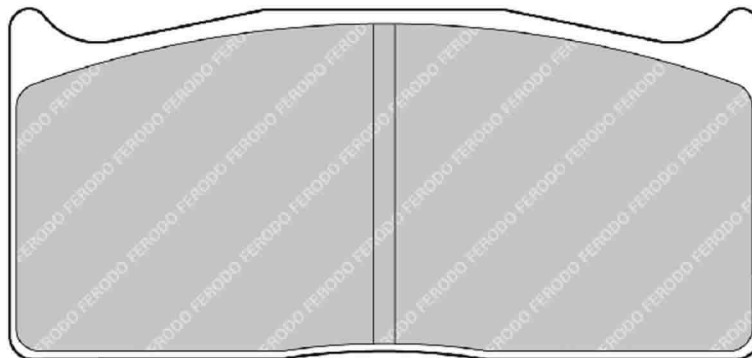

ALSO AVAILABLE		
SHAPE	TH. MM	NOTES
FRP1079	16	

CROSS REFERENCE	
BREMBO	07.5064.27
BREMBO	07.5064.7
BREMBO	07.5064.72
BREMBO	07.5064.73
PAGID	1283
PFC	7735.XX.20

MATERIAL AVAILABILITY						
H	C	R	W	WB	Z	ZB
✓	✗	✓	✓		✓	

- ✓ Available
- ✗ Out of Range
- ✗ Exhausting
- ✗ Make to order
- ✗ In Introduction

FRP501

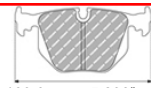

133.0mm = 5.236"



71.0mm = 2.795"



20.0mm = 0.787"



43.0mm = 1.693"

OPEL Front

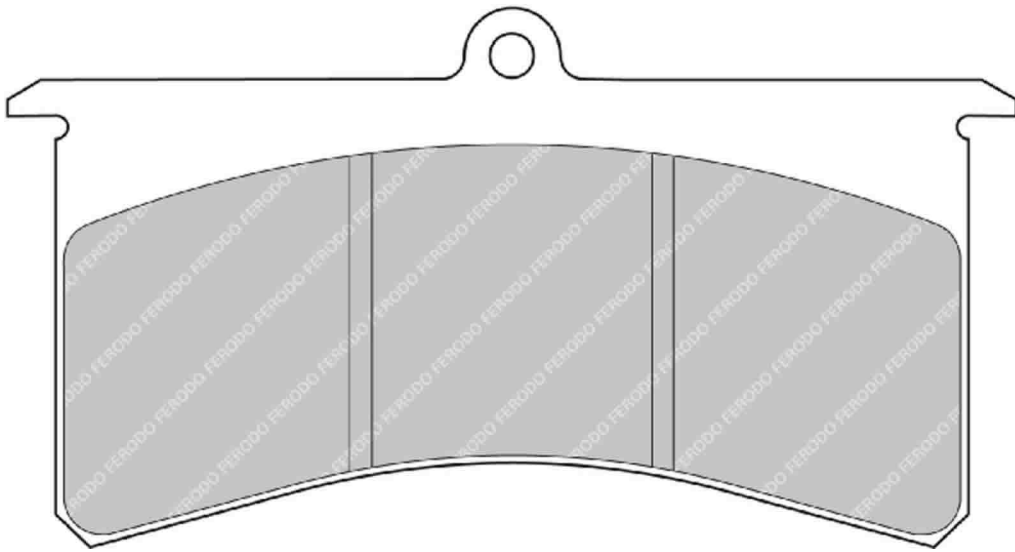

Same as FRP3097 but NON-fixed bridge caliper

ALSO AVAILABLE		
SHAPE	TH. MM	NOTES
FRP3097	none	Fixed Bridge Caliper

CROSS REFERENCE	
AP RACING	CP4751D43
PAGID	2555
PFC	7751

MATERIAL AVAILABILITY						
H	C	R	W	WB	Z	ZB
✓		✓	✓			

FRP502



100.7mm = 3.965"



60.0mm = 2.362"



12.5mm = 0.492"

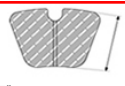

46.4mm = 1.827"

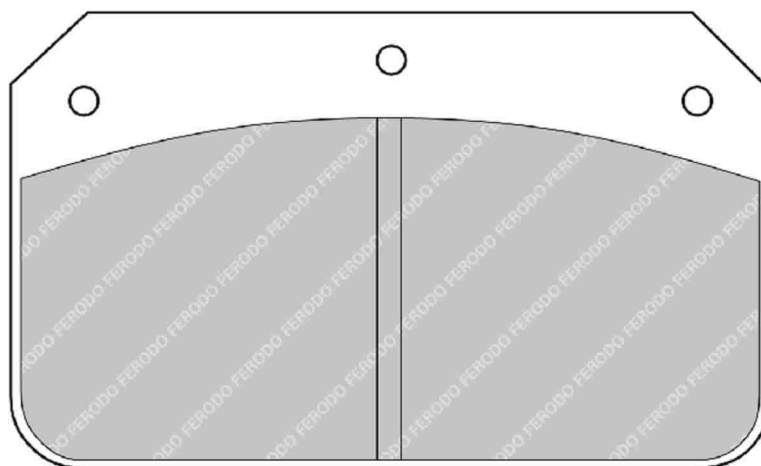

MATERIAL AVAILABILITY						
H	C	R	W	WB	Z	ZB
✓	✓	✓	✓			

CROSS REFERENCE	
ALCON	PNF0084X284
ALCON	PNF0084X284.4
PAGID	1796
PFC	7752

3244

FRP503

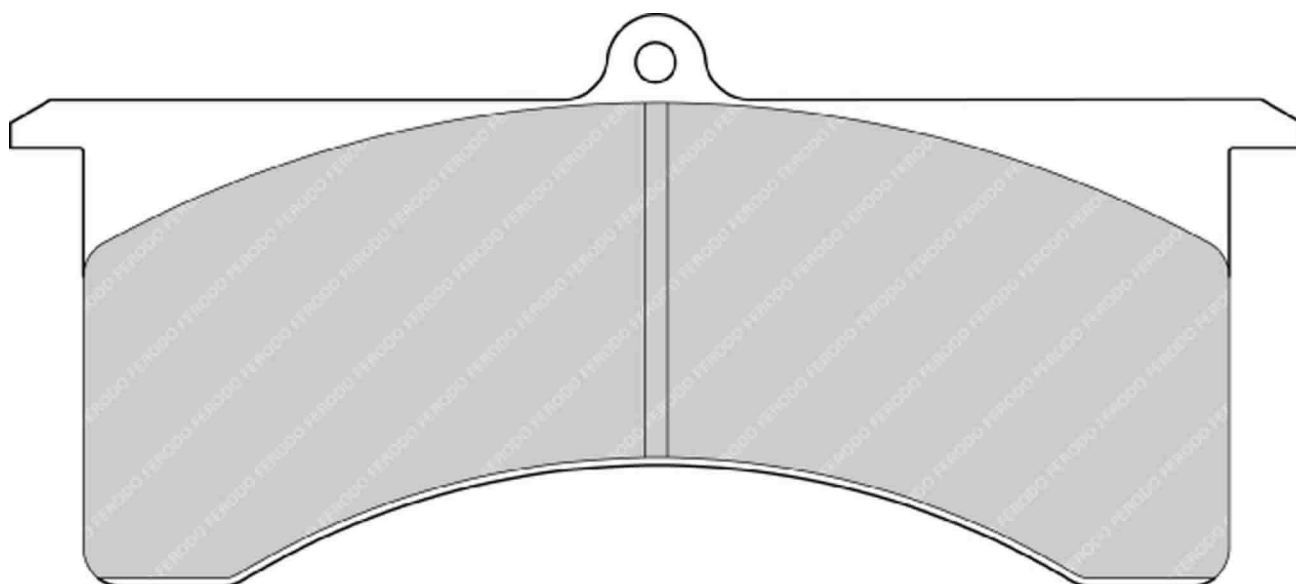
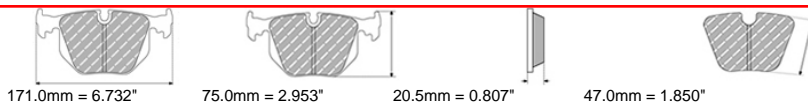

MATERIAL AVAILABILITY						
H	C	R	W	WB	Z	ZB
✗		✓	✓			

CROSS REFERENCE	
ALCON	PNF0084X350.4
AP RACING	CP5805D45
PAGID	1798USA

FRP504

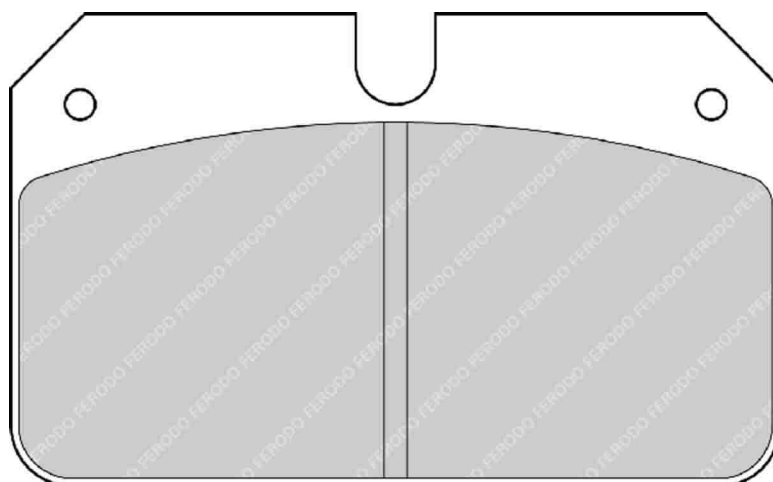
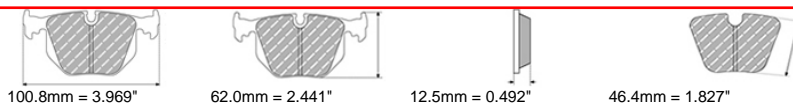

MATERIAL AVAILABILITY						
H	C	R	W	WB	Z	ZB
✉		✓	✓		✓	

CROSS REFERENCE	
PFC	7754

- ✓ Available
- ✗ Out of Range
- ✉ In Introduction
- ⚠ Exhausting
- ✉ Make to order

FRP506



50.5mm = 1.988"



61.0mm = 2.402"

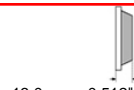

13.0mm = 0.512"

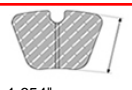

42.0mm = 1.654"

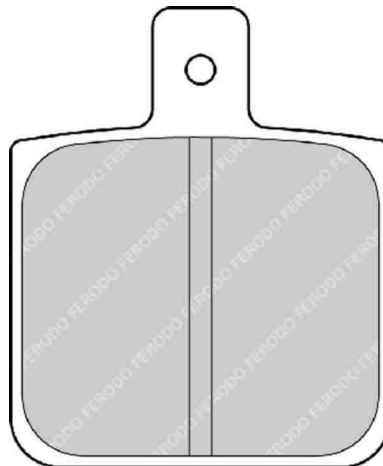

MATERIAL AVAILABILITY						
H	C	R	W	WB	Z	ZB

CROSS REFERENCE	
PAGID	1809USA
PFC	7757

FRP1058



79.8mm = 3.142"

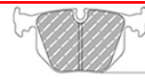

56.0mm = 2.205"



18.0mm = 0.709"



45.5mm = 1.791"

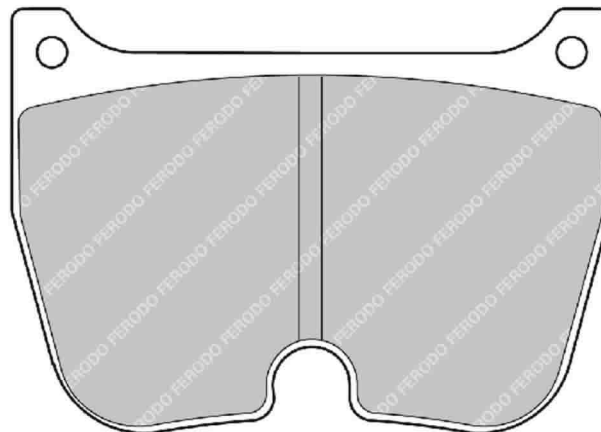

4 Pistons caliper

(1 set = 4 pads) - 2 sets per axle for the recommended applications

ALSO AVAILABLE		
SHAPE	TH. MM	NOTES
FRP1064	20	

CROSS REFERENCE	
BREMBO	07.5684.2
PFC	7748.XX.18

MATERIAL AVAILABILITY						
H	C	R	W	WB	Z	ZB

FRP1059



84.8mm = 3.333"



68.0mm = 2.677"



22.0mm = 0.866"

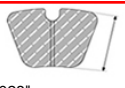

51.5mm = 2.028"

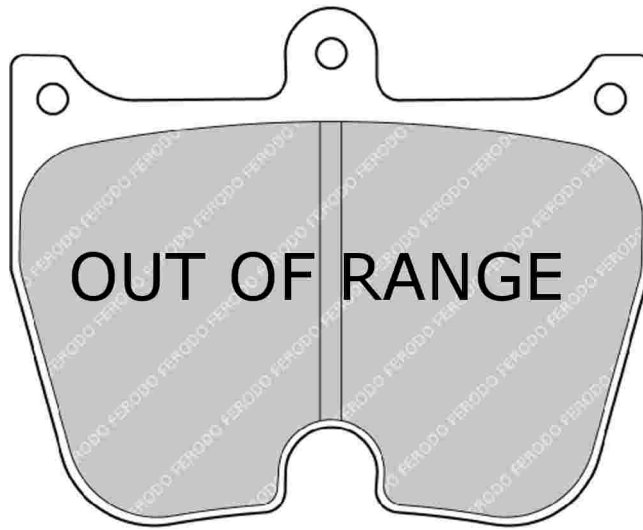

4 Pistons caliper

(1 set = 4 pads) - 2 sets per axle for the recommended applications

ALSO AVAILABLE

SHAPE	TH. MM	NOTES
FRP3004	20	
FRP3034	21	
FRP3045	18	

CROSS REFERENCE

BREMBO	07.5868
PAGID	2105
PFC	7742.XX.22
PFC	7802.XX.22

MATERIAL AVAILABILITY

H	C	R	W	WB	Z	ZB
		✘				

FRP1060

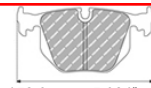

152.0mm = 5.984"



77.0mm = 3.031"



25.0mm = 0.984"

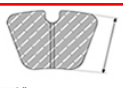

45.0mm = 1.772"

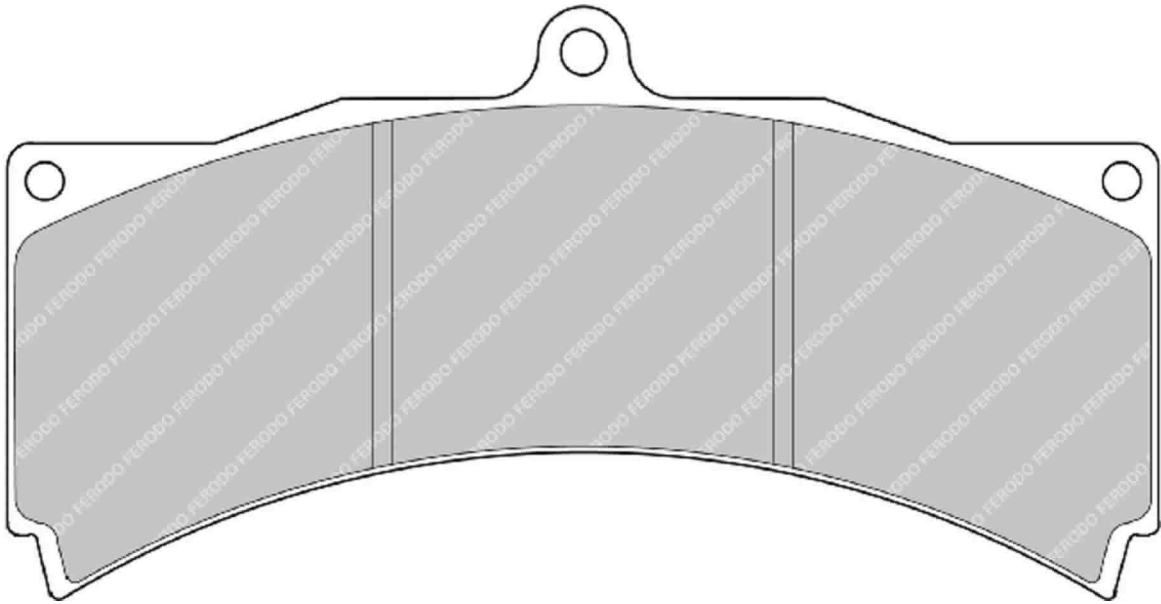

ALSO AVAILABLE

SHAPE	TH. MM	NOTES
FRP3000	18	

CROSS REFERENCE

AP RACING	CP3558D46
PAGID	1813

MATERIAL AVAILABILITY

H	C	R	W	WB	Z	ZB
		✓			✓	

FRP1061



94.6mm = 3.724"

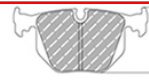

53.0mm = 2.087"



16.0mm = 0.630"



45.0mm = 1.772"

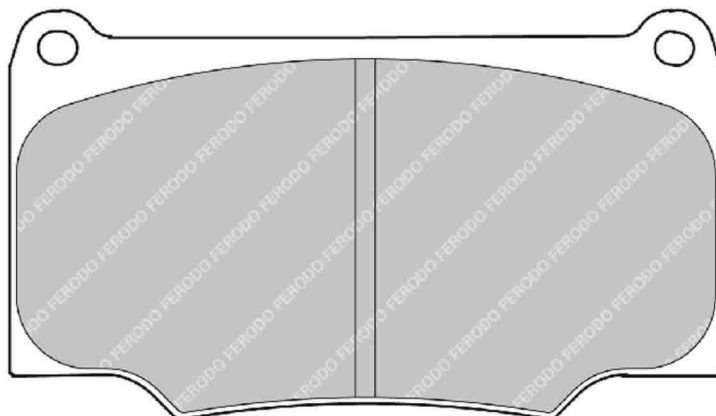

MATERIAL AVAILABILITY

H	C	R	W	WB	Z	ZB
		✗				

CROSS REFERENCE

AP RACING	CP4296D43
PAGID	2141
PFC	7708

3248

FERODO

RACING

Updated on 17th Aug 2018

✓ Available
 ✗ Out of Range
 ⚙ In Introduction
 ⚠ Exhausting
 📦 Make to order

FRP1064

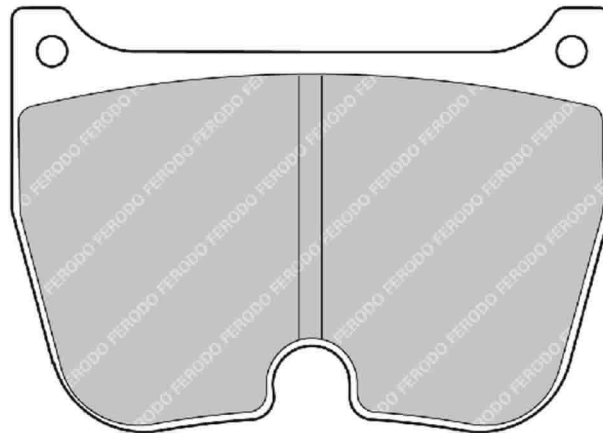
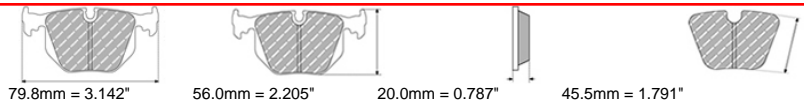

4 Pistons caliper

(1 set = 4 pads) - 2 sets per axle for the recommended applications

ALSO AVAILABLE		
SHAPE	TH. MM	NOTES
FRP1058	18	

MATERIAL AVAILABILITY						
H	C	R	W	WB	Z	ZB

CROSS REFERENCE	
ALCON	PNF0084X282.4
BREMBO	07.5684.2
BREMBO	07.5684.25
BREMBO	07.5684.26
PAGID	2053
PFC	7748.XX.20

FRP1077

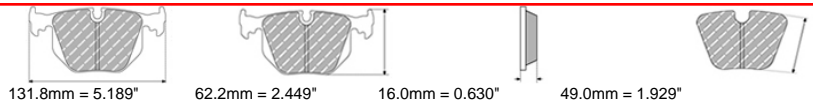

CITROEN Front / Rear, FERRARI Rear, PEUGEOT Front

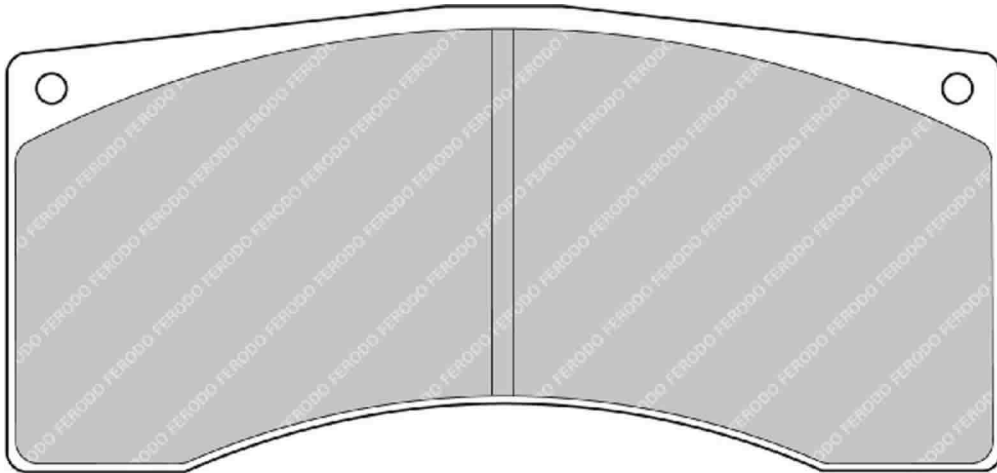

ALSO AVAILABLE		
SHAPE	TH. MM	NOTES
FRP302	20	
FRP1078	25	
FRP3007	18	

MATERIAL AVAILABILITY						
H	C	R	W	WB	Z	ZB
✓		✓	✓		✓	

CROSS REFERENCE	
ALCON	PNF4441X723
ALCON	PNF4441X723.4
ALCON	PNF4441X753
ALCON	PNF4441X753S.4
ALCON	PNF4441X769.4
BREMBO	07.5139.0
BREMBO	07.5139.07
BREMBO	07.5139.19
CL BRAKES	5005W50TX
HAWK	HB105 0,62
PAGID	1595
PFC	7700.XX.16

FRP1078



131.8mm = 5.189"



62.2mm = 2.449"



25.0mm = 0.984"



49.0mm = 1.929"

BMW Rear, FERRARI Front / Rear, PORSCHE Rear

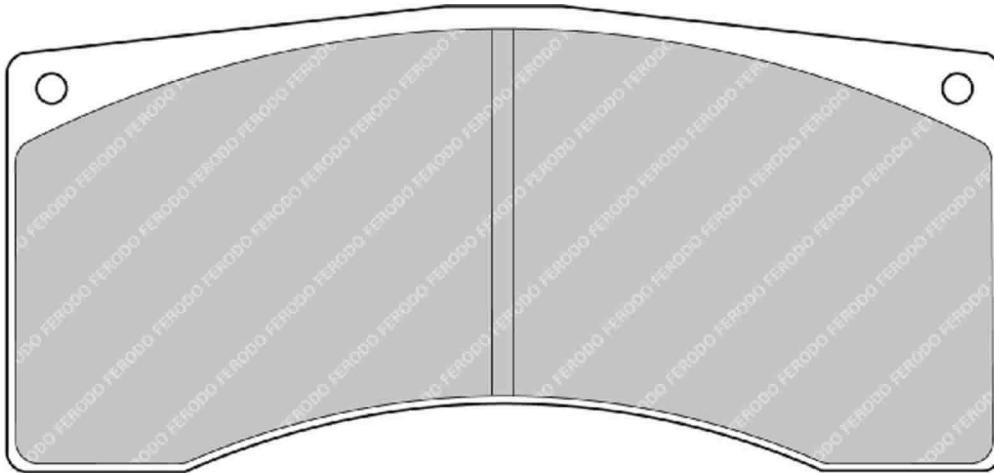

ALSO AVAILABLE		
SHAPE	TH. MM	NOTES
FRP302	20	
FRP1077	16	
FRP3007	18	

CROSS REFERENCE	
AP RACING	CP6070D49
BREMBO	07.5139.3
BREMBO	07.5139.34
BREMBO	07.5139.81
PAGID	1674
PFC	7700.XX.25

MATERIAL AVAILABILITY						
H	C	R	W	WB	Z	ZB
		✓	✗	✓	✗	✉

FRP1079



99.8mm = 3.929"



46.0mm = 1.811"



16.0mm = 0.630"



43.6mm = 1.717"

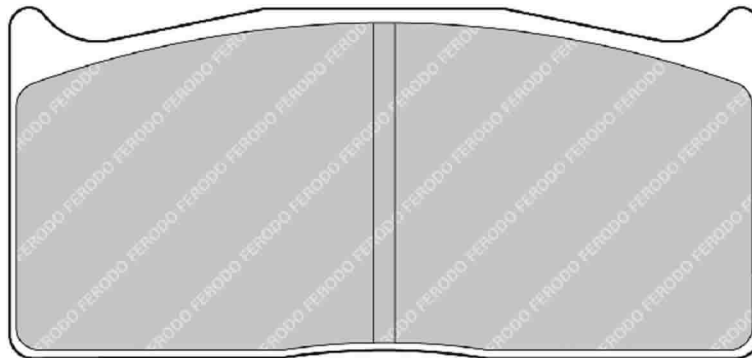

ALSO AVAILABLE		
SHAPE	TH. MM	NOTES
FRP308	20	

CROSS REFERENCE	
ALCON	PNF0084X322.4
BREMBO	07.5064.49
BREMBO	07.5064.8
BREMBO	07.5064.82
BREMBO	07.5064.84
PAGID	1705
PFC	7735.XX.16

MATERIAL AVAILABILITY						
H	C	R	W	WB	Z	ZB
✉	✉	✓				

- ✓ Available
- ✗ Out of Range
- ✉ In Introduction
- ⚠ Exhausting
- ✉ Make to order

FRP3000

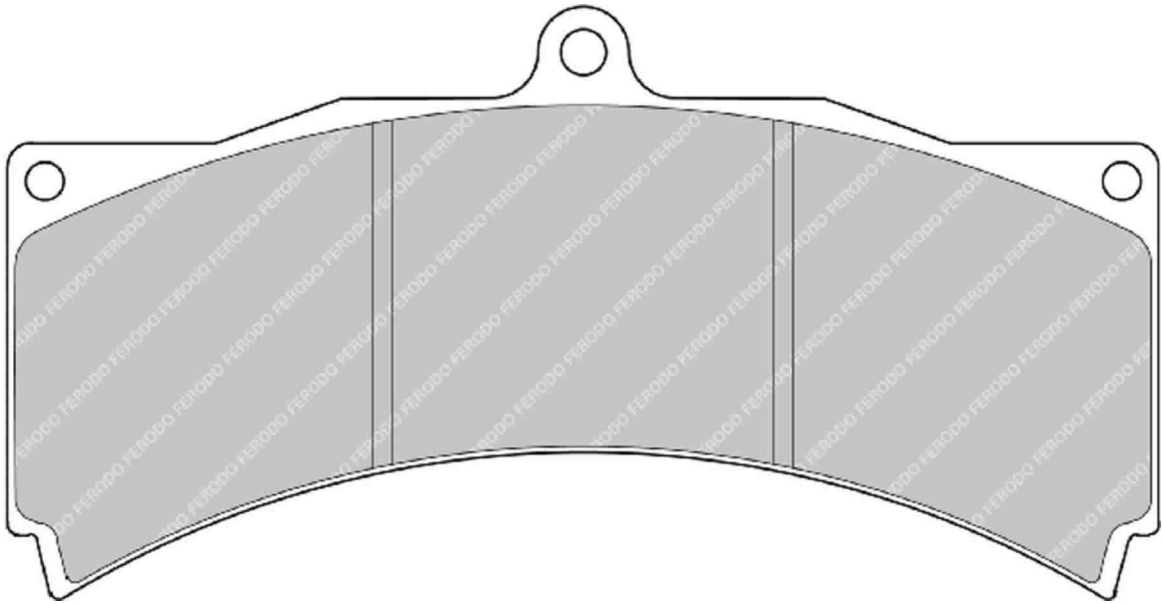
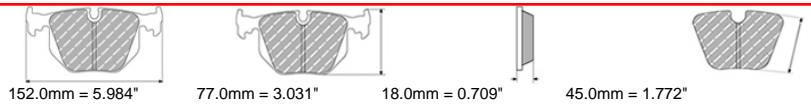

ALSO AVAILABLE		
SHAPE	TH. MM	NOTES
FRP1060	25	

MATERIAL AVAILABILITY						
H	C	R	W	WB	Z	ZB
✓		✓	📦			

CROSS REFERENCE	
ALCON	PNF4489X519.4
ALCON	PNF4489X562.4
ALCON	PNF4489X565.4
AP RACING	CP3894D46
PAGID	1852

FRP3001

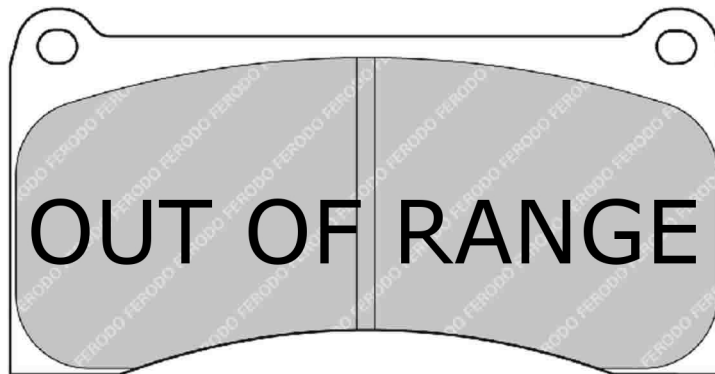

April 2018: Out of range

MATERIAL AVAILABILITY						
H	C	R	W	WB	Z	ZB
✗	✗	✗				

CROSS REFERENCE	
AP RACING	CP4140D36

FRP3003

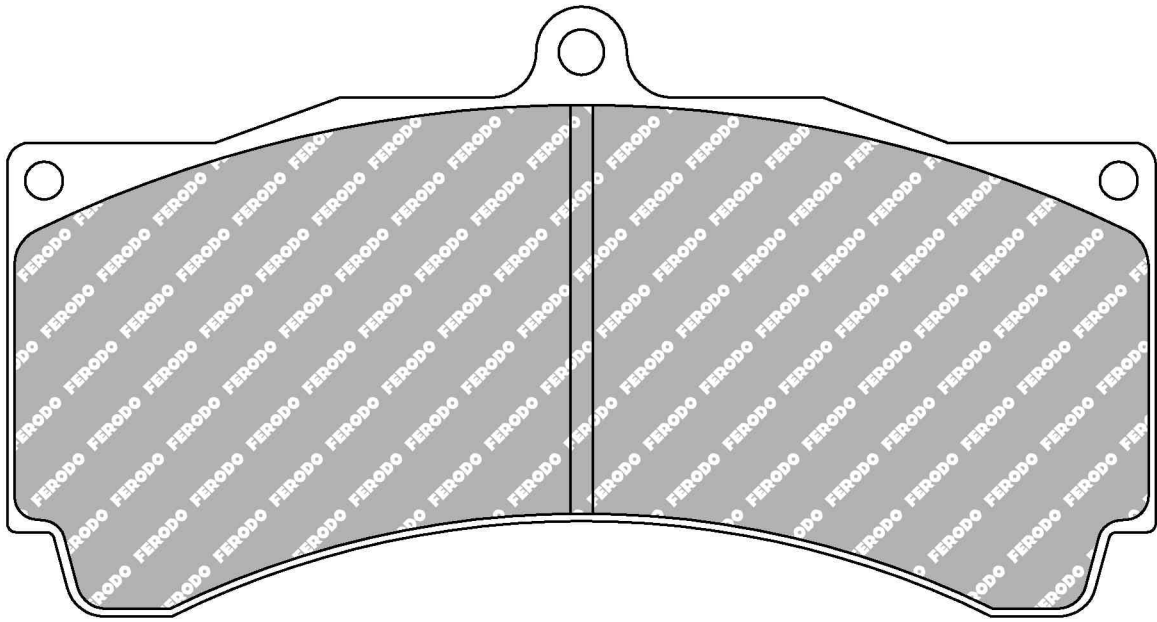
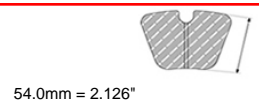
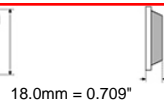
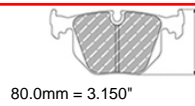
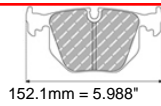

ALSO AVAILABLE		
SHAPE	TH. MM	NOTES
FRP3014	25	without top tab
FRP3015	28.5	without top tab
FRP3077	17	with top tab
FRP3144	18	without top tab
FRP3145	17	without top tab

CROSS REFERENCE	
ALCON	PNF4489X532.4
AP RACING	CP3894D54
HAWK	HB109 0,71
PAGID	1904
PFC	7790.XX.18

MATERIAL AVAILABILITY						
H	C	R	W	WB	Z	ZB
✓		✓	✓		✗	

✓ Available ⚠ Exhausting
 ✗ Out of Range 📦 Make to order
 📅 In Introduction

FRP3004

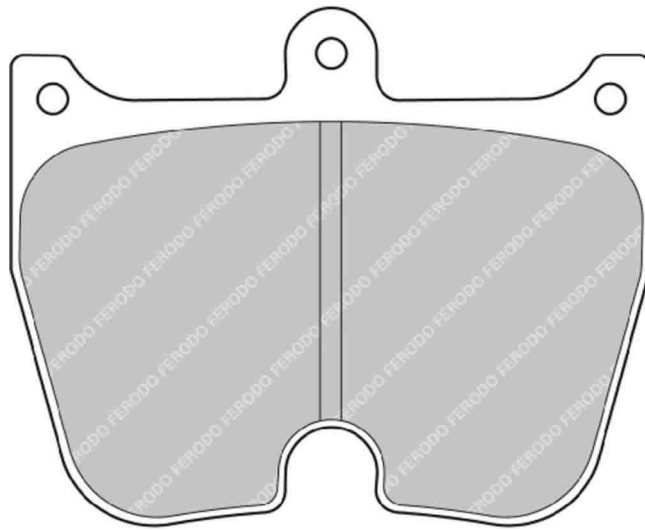
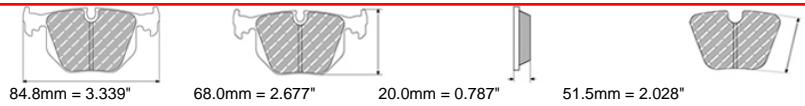

4 Pistons caliper

(1 set = 4 pads) - 2 sets per axle for the recommended applications

ALSO AVAILABLE

SHAPE	TH. MM	NOTES
FRP1059	22	
FRP3034	21	
FRP3045	18	

MATERIAL AVAILABILITY

H	C	R	W	WB	Z	ZB

CROSS REFERENCE

ALCON	PNF0084X283.4
BREMBO	07.5868.2
BREMBO	07.5868.29
PFC	7742.XX.20
PFC	7802.XX.20

FRP3006



152.0mm = 5.984"



80.0mm = 3.150"



16.0mm = 0.630"

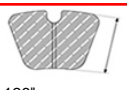

54.0mm = 2.126"

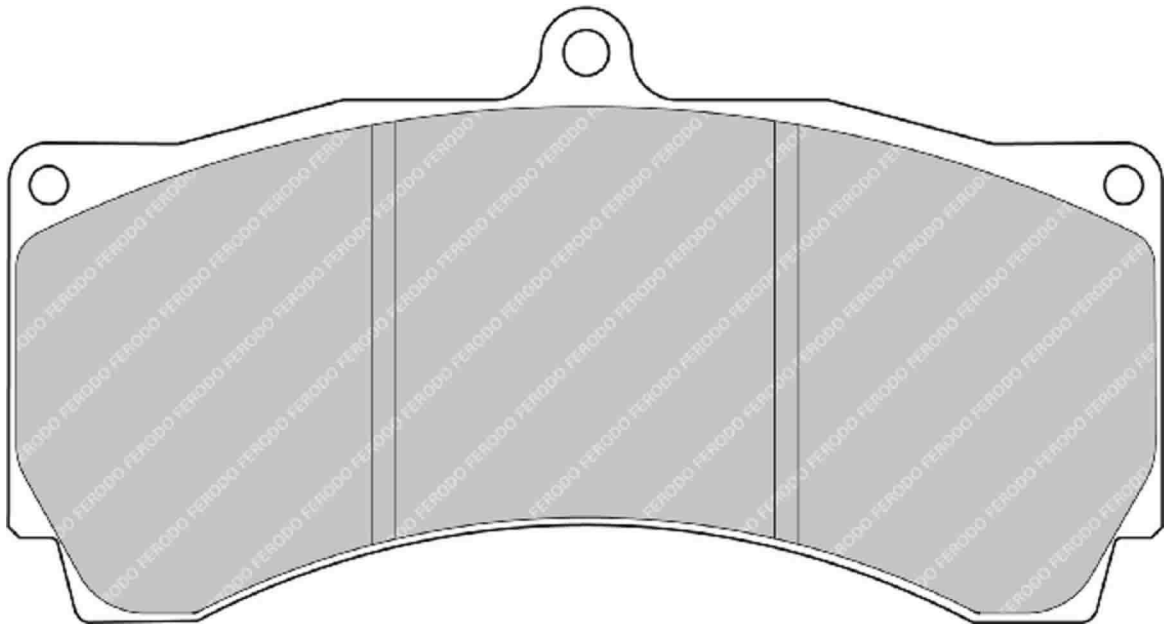

MATERIAL AVAILABILITY

H	C	R	W	WB	Z	ZB

CROSS REFERENCE

AP RACING	CP3796D54
-----------	-----------

Available
 Out of Range
 In Introduction
 Exhausting
 Make to order

FRP3007



131.8mm = 5.189"



62.2mm = 2.449"



18.0mm = 0.709"

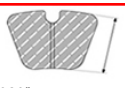

49.0mm = 1.929"

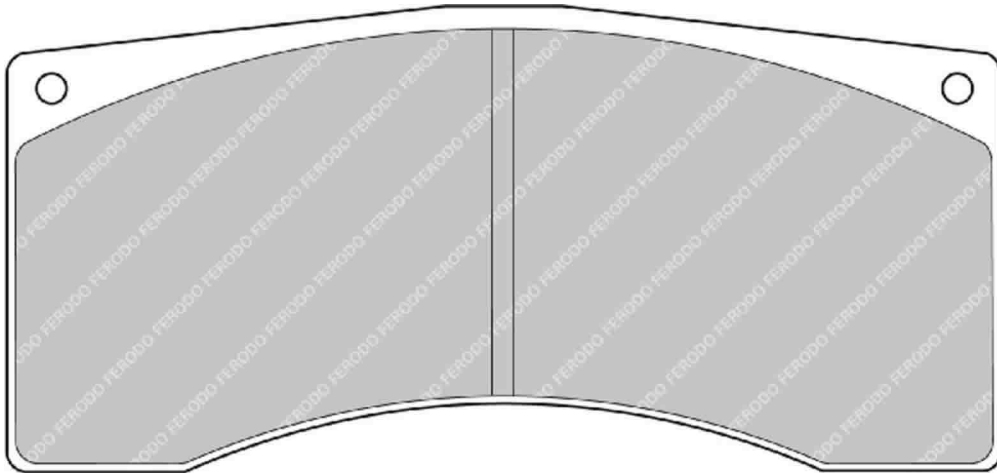

ALSO AVAILABLE

SHAPE	TH. MM	NOTES
FRP302	20	
FRP1077	16	
FRP1078	25	

CROSS REFERENCE

PFC	7700.XX.18
-----	------------

MATERIAL AVAILABILITY

H	C	R	W	WB	Z	ZB

FRP3009

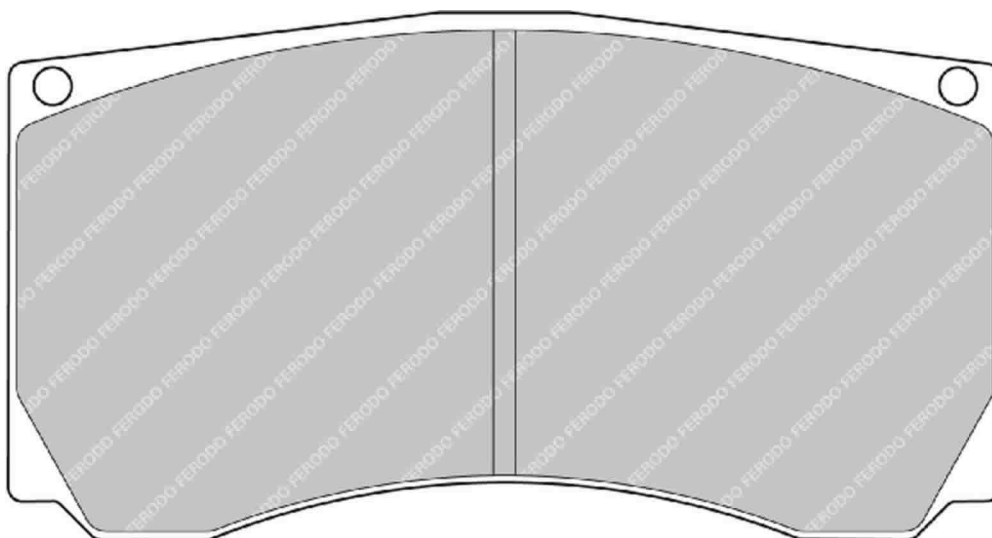
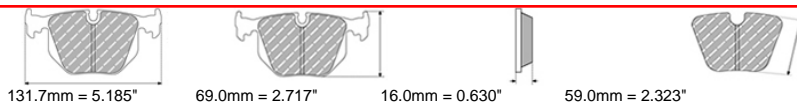

ALSO AVAILABLE		
SHAPE	TH. MM	NOTES
FRP3012	20	

MATERIAL AVAILABILITY						
H	C	R	W	WB	Z	ZB

CROSS REFERENCE	
ALCON	PNF4476X545
ALCON	PNF4476X545.4
PAGID	2743
PFC	7755

Available
 Exhausting
 Out of Range
 Make to order
 In Introduction

FRP3012

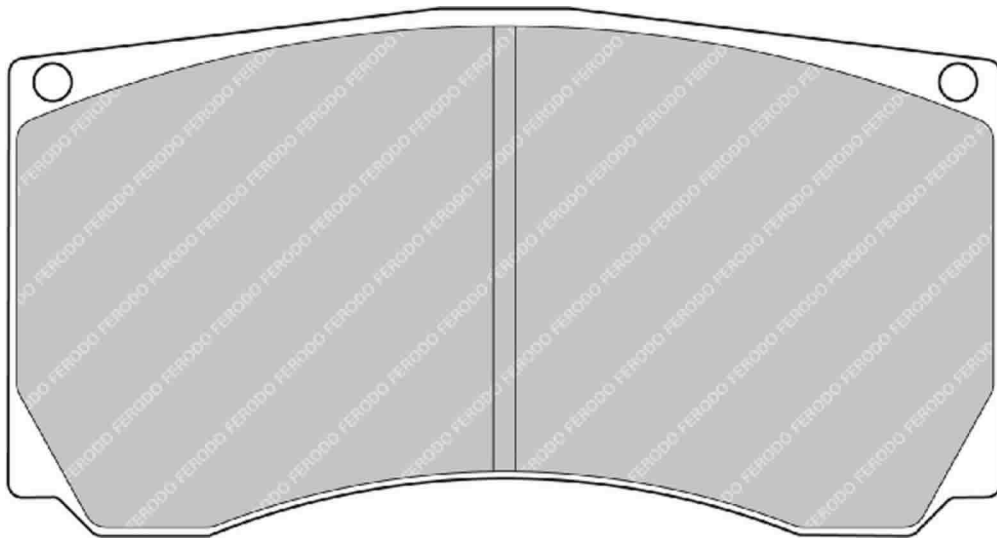
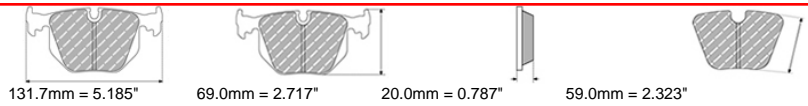

ALSO AVAILABLE		
SHAPE	TH. MM	NOTES
FRP3009	16	

MATERIAL AVAILABILITY						
H	C	R	W	WB	Z	ZB

CROSS REFERENCE	
ALCON	PNF4476X549
ALCON	PNF4476X549.4
PAGID	1756
PFC	7756

FRP3014

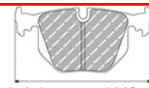

152.1mm = 5.988"



68.9mm = 2.713"



25.0mm = 0.984"

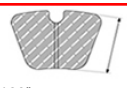

54.0mm = 2.126"

SEAT Front

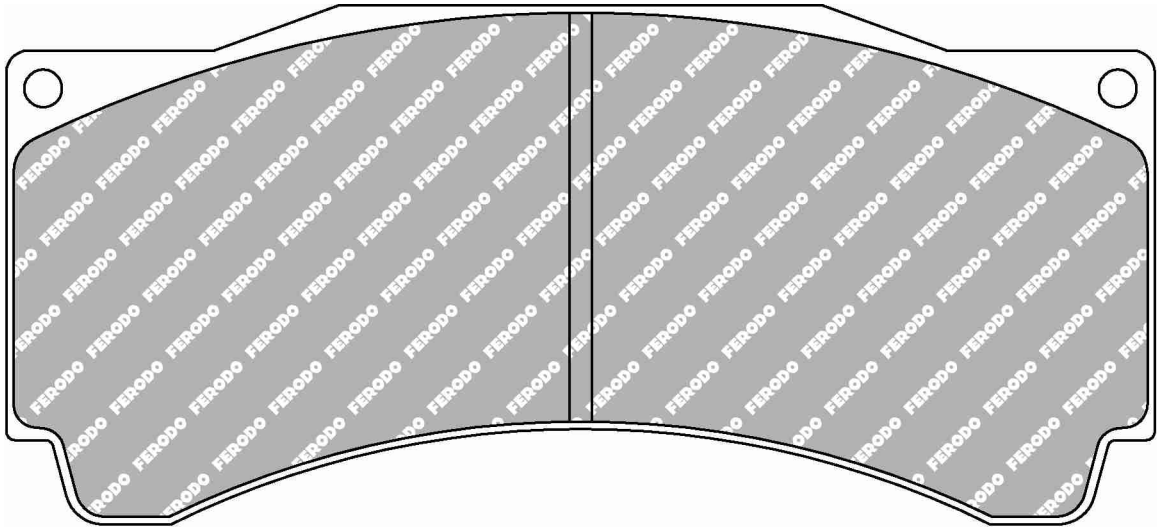

ALSO AVAILABLE

SHAPE	TH. MM	NOTES
FRP3003	18	with top tab
FRP3015	28.5	without top tab
FRP3077	17	with top tab
FRP3144	18	without top tab
FRP3145	17	without top tab

CROSS REFERENCE

AP RACING	CP3558D54
PAGID	8245
PFC	7790.XX.25

MATERIAL AVAILABILITY

H	C	R	W	WB	Z	ZB

Available
 Out of Range
 In Introduction
 Exhausting
 Make to order

FRP3015

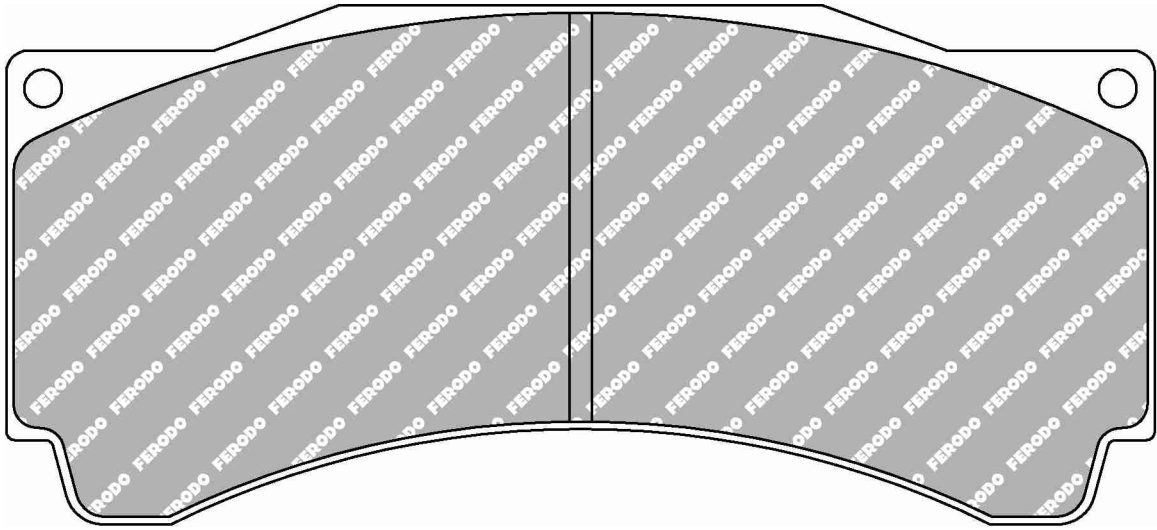
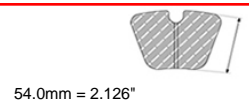
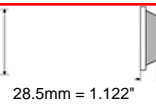
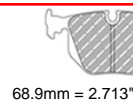
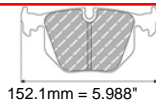

ALSO AVAILABLE		
SHAPE	TH. MM	NOTES
FRP3003	18	with top tab
FRP3014	25	without top tab
FRP3077	17	with top tab
FRP3144	18	without top tab
FRP3145	17	without top tab

CROSS REFERENCE	
ALCON	PNF4489X543
AP RACING	CP4595D54
PAGID	8250
PFC	7790.XX.28

MATERIAL AVAILABILITY						
H	C	R	W	WB	Z	ZB

FRP3018

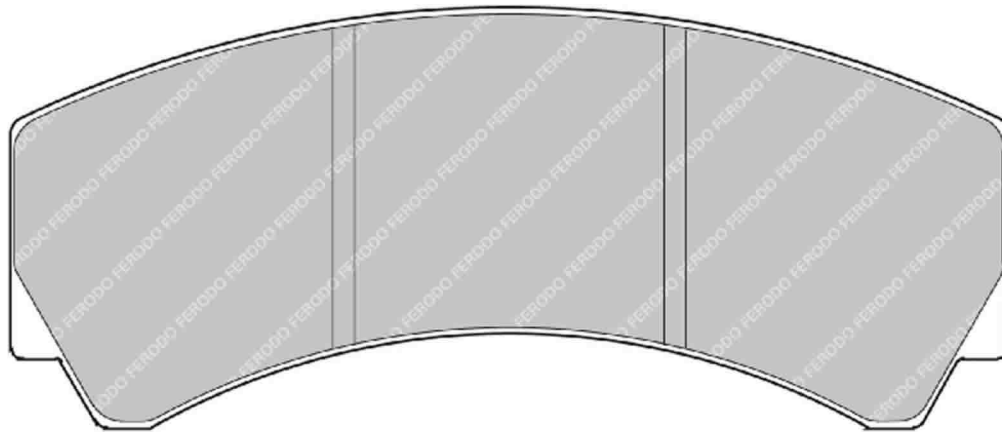
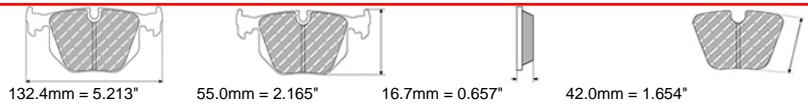

ALSO AVAILABLE		
SHAPE	TH. MM	NOTES
FRP3073	20.3	

CROSS REFERENCE	
ALCON	PNF0084X276.4
AP RACING	CP3215D42
PAGID	2126
PFC	7768.XX.16

MATERIAL AVAILABILITY						
H	C	R	W	WB	Z	ZB
✓		✓	✗	✓	✉	

FRP3020

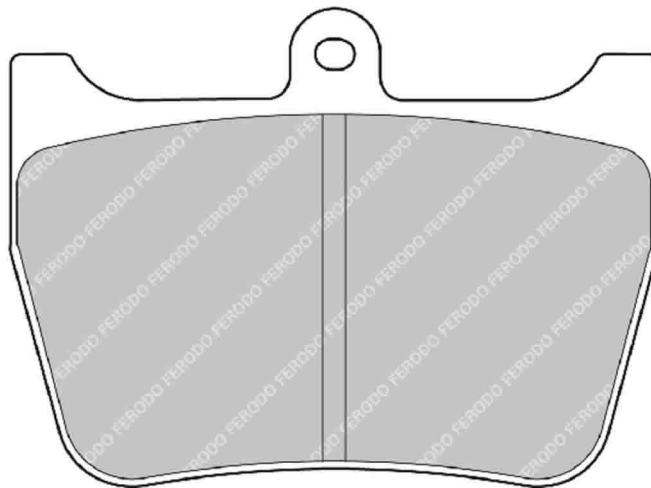
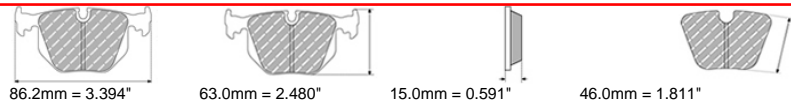

4 Pistons caliper (1 set = 4 pads) - 2 sets per axle for the recommended applications

ALSO AVAILABLE		
SHAPE	TH. MM	NOTES
FRP3086	18	

CROSS REFERENCE	
AP RACING	CP5148D46
PFC	7804.XX.15

MATERIAL AVAILABILITY						
H	C	R	W	WB	Z	ZB
		✓				

- ✓ Available
- ✗ Out of Range
- ✉ In Introduction
- ⚠ Exhausting
- ✉ Make to order

FRP3021

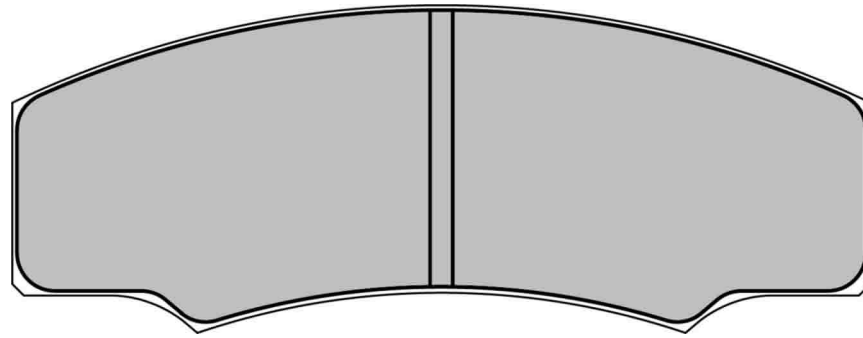
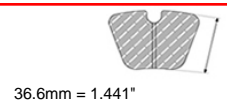
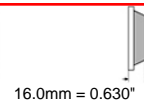
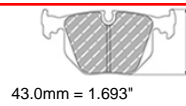
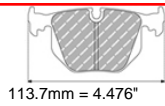

MATERIAL AVAILABILITY						
H	C	R	W	WB	Z	ZB

CROSS REFERENCE	
AP RACING	CP2340D38

FRP3022

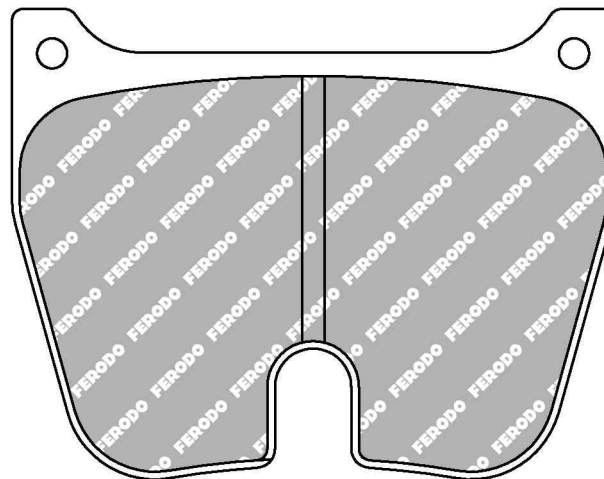
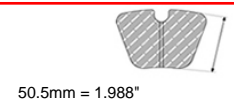
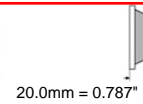
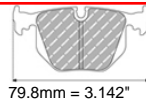

4 Pistons caliper (1 set = 4 pads) - 2 sets per axle for the recommended applications

ALSO AVAILABLE		
SHAPE	TH. MM	NOTES
FRP3023	17.5	
FRP3033	21	

CROSS REFERENCE	
BREMBO	07.5684.5
BREMBO	07.5684.52
BREMBO	07.5684.56
PFC	7743.XX.20

MATERIAL AVAILABILITY						
H	C	R	W	WB	Z	ZB

FRP3023



79.8mm = 3.142"



62.0mm = 2.441"



17.5mm = 0.689"

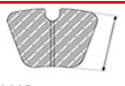

50.5mm = 1.988"

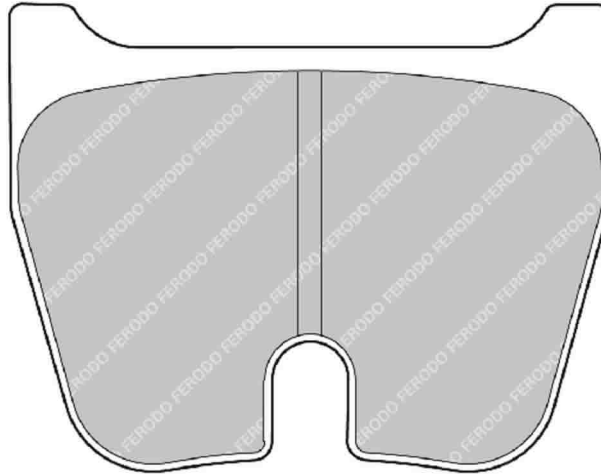

4 Pistons caliper (1 set = 4 pads) - 2 sets per axle for the recommended applications

ALSO AVAILABLE

SHAPE	TH. MM	NOTES
FRP3022	20	
FRP3033	21	

MATERIAL AVAILABILITY

H	C	R	W	WB	Z	ZB
		✓				

CROSS REFERENCE

BREMBO	07.5684.5
BREMBO	07.5684.53
BREMBO	07.5684.55
PFC	7743.XX.17

FRP3024



139.8mm = 5.504"



61.4mm = 2.417"



20.0mm = 0.787"

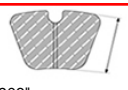

48.4mm = 1.906"

FERRARI Front

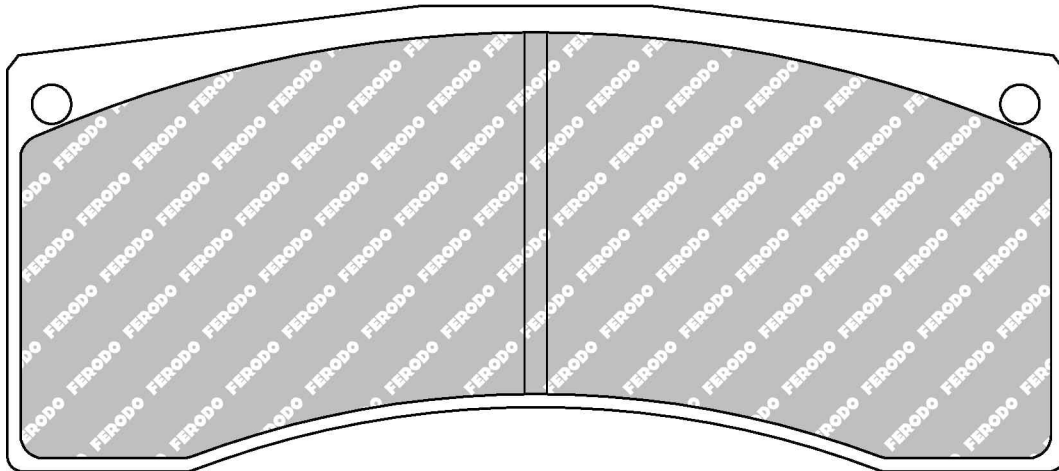

ALSO AVAILABLE

SHAPE	TH. MM	NOTES
FRP3029	26	
FRP3030	28	
FRP3087	17.5	
FRP3140	16	

MATERIAL AVAILABILITY

H	C	R	W	WB	Z	ZB
		✓	✓		✓	

CROSS REFERENCE

AP RACING	CP5788D48
BREMBO	07.5169.9
BREMBO	07.5169.90
BREMBO	07.5169.92
PAGID	1896
PFC	7770.XX.20

FRP3025

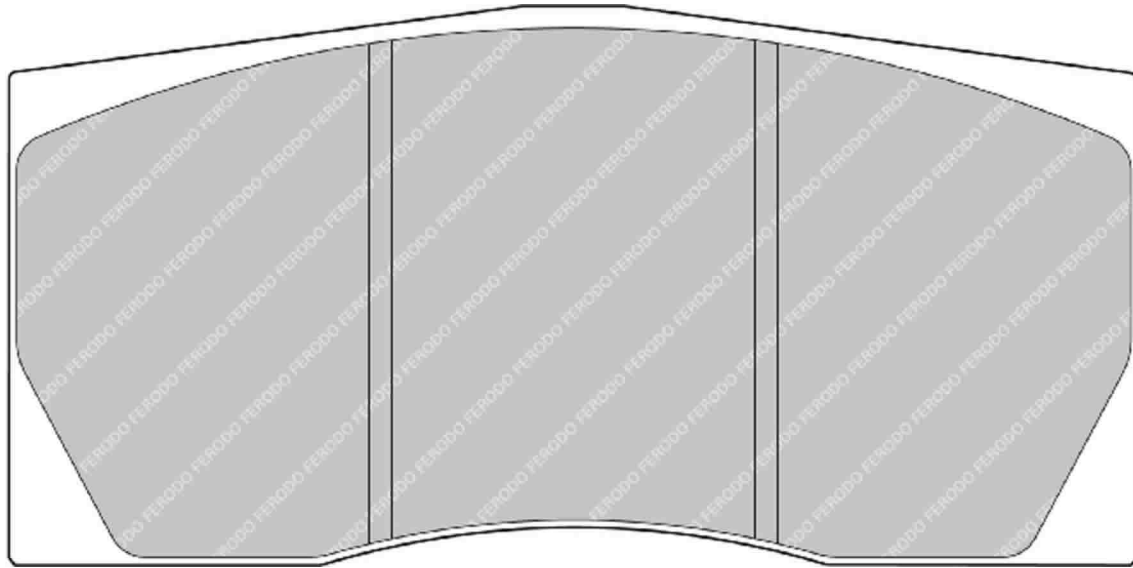
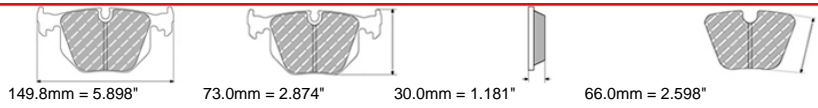

MATERIAL AVAILABILITY						
H	C	R	W	WB	Z	ZB

CROSS REFERENCE	
ALCON	PNF0084X305.4
PFC	7683

FRP3026

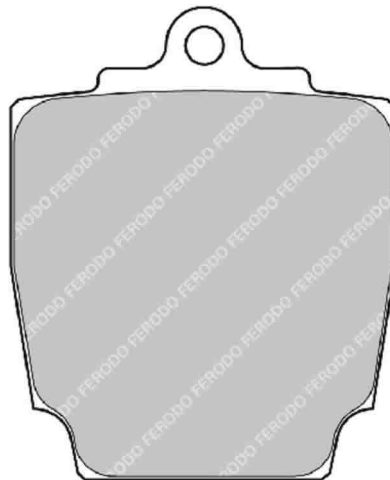
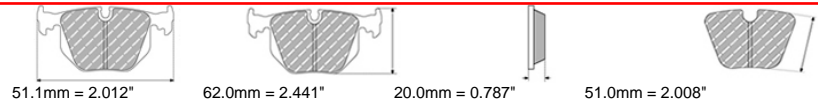

MATERIAL AVAILABILITY						
H	C	R	W	WB	Z	ZB

CROSS REFERENCE	
ALCON	PNF4493X501.4
ALCON	PNF4493X502
ALCON	PNF4493X503

- Available
- Out of Range
- In Introduction
- Exhausting
- Make to order

FRP3027

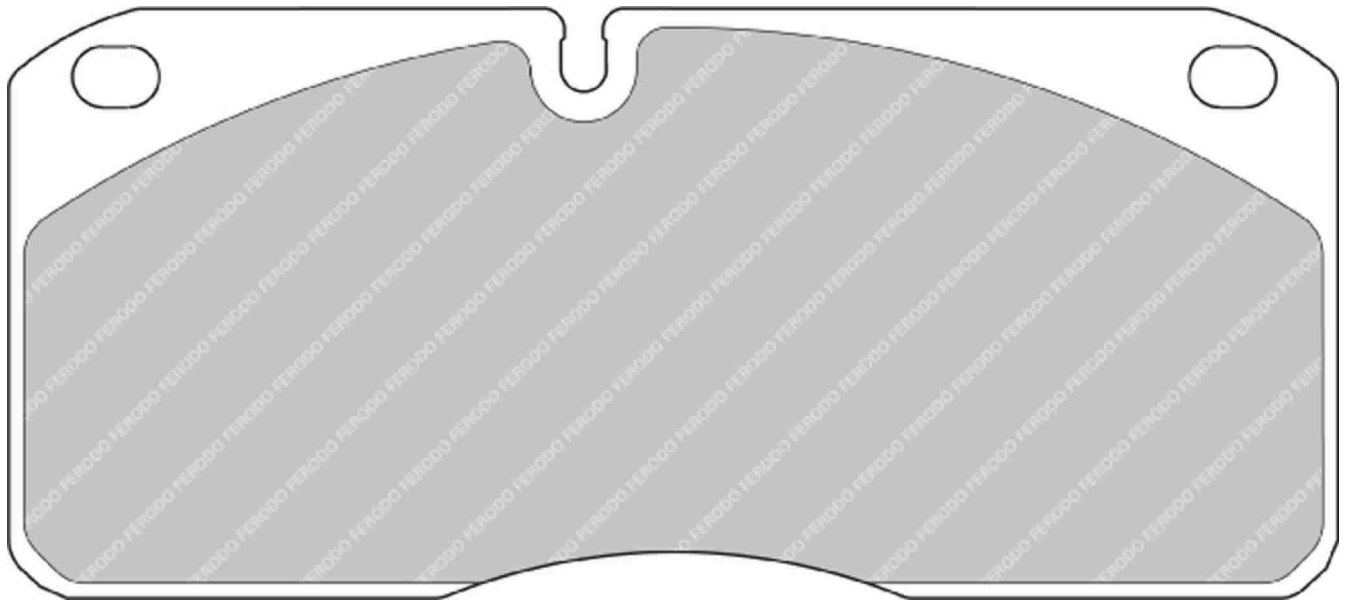
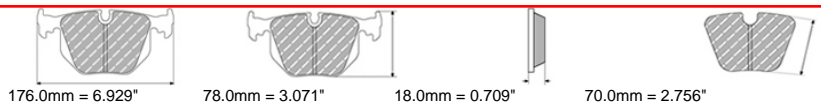

MATERIAL AVAILABILITY						
H	C	R	W	WB	Z	ZB
✓		✉				

CROSS REFERENCE	
ALCON	PNF0084X222
ALCON	PNF0084X222.4
AP RACING	CP8310D70

FRP3028

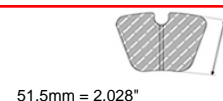
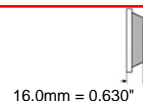
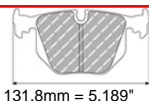

ASTON MARTIN Front

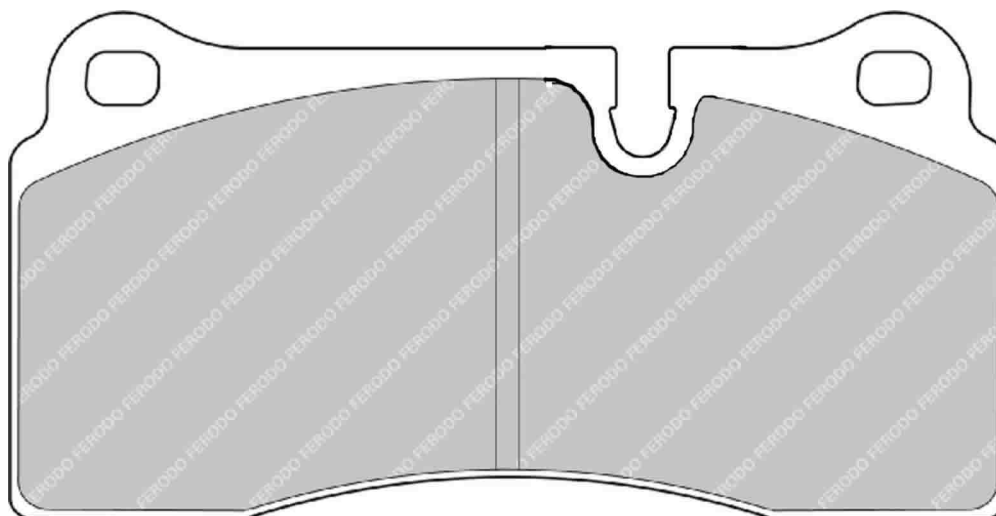

ALSO AVAILABLE		
SHAPE	TH. MM	NOTES
FCP1281	18.2	

CROSS REFERENCE	
HAWK	HB193 0,61
PFC	7780.XX.16

MATERIAL AVAILABILITY						
H	C	R	W	WB	Z	ZB
✓		✓	✉		✉	

✓ Available ⚠ Exhausting
 ✗ Out of Range ✉ Make to order
 ⓘ In Introduction

FRP3029



139.8mm = 5.504"



61.4mm = 2.417"



26.0mm = 1.024"

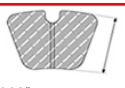

48.4mm = 1.906"

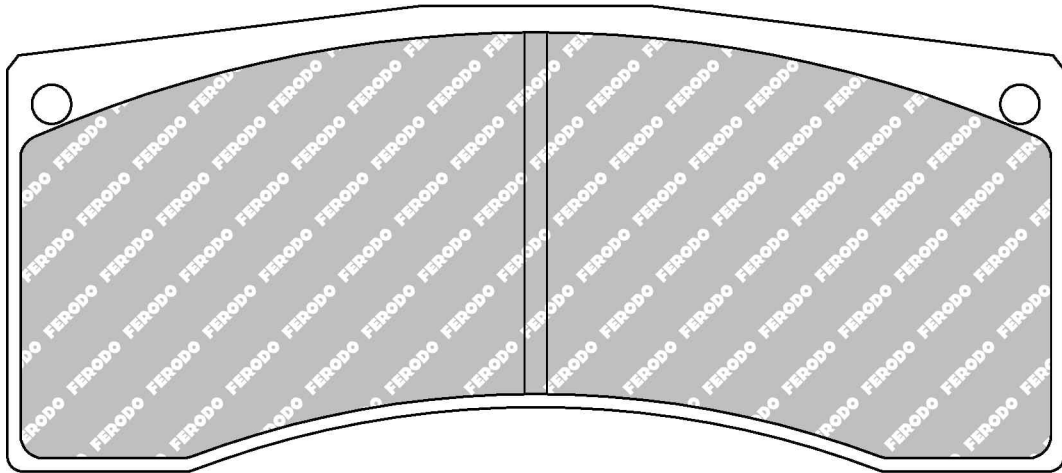

ALSO AVAILABLE		
SHAPE	TH. MM	NOTES
FRP3024	20	
FRP3030	28	
FRP3087	17.5	
FRP3140	16	

CROSS REFERENCE	
BREMBO	07.7859.1
BREMBO	07.7859.10
BREMBO	07.7859.11
PAGID	1619
PFC	7770.XX.26

MATERIAL AVAILABILITY						
H	C	R	W	WB	Z	ZB

FRP3030



139.8mm = 5.504"



61.4mm = 2.417"



28.0mm = 1.102"

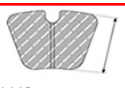

48.4mm = 1.906"

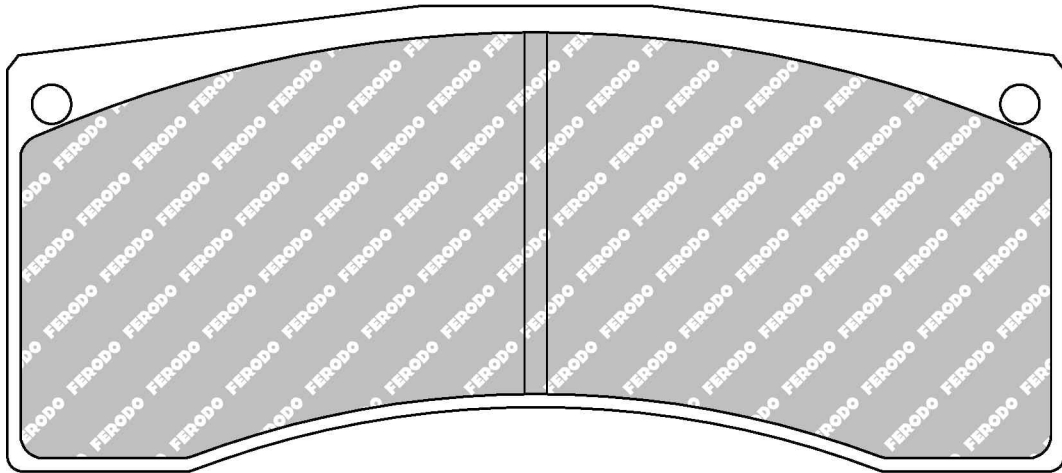

ALSO AVAILABLE

SHAPE	TH. MM	NOTES
FRP3024	20	
FRP3029	26	
FRP3087	17.5	
FRP3140	16	

MATERIAL AVAILABILITY

H	C	R	W	WB	Z	ZB

CROSS REFERENCE

BREMBO	07.7859.2
BREMBO	07.7859.20
BREMBO	07.7859.21
PAGID	1618
PAGID	1618
PFC	7770.XX.26

Available
 Out of Range
 In Introduction
 Exhausting
 Make to order

FRP3031



163.8mm = 6.449"



66.0mm = 2.598"



29.0mm = 1.142"

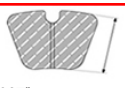

52.5mm = 2.067"

PORSCHE Front

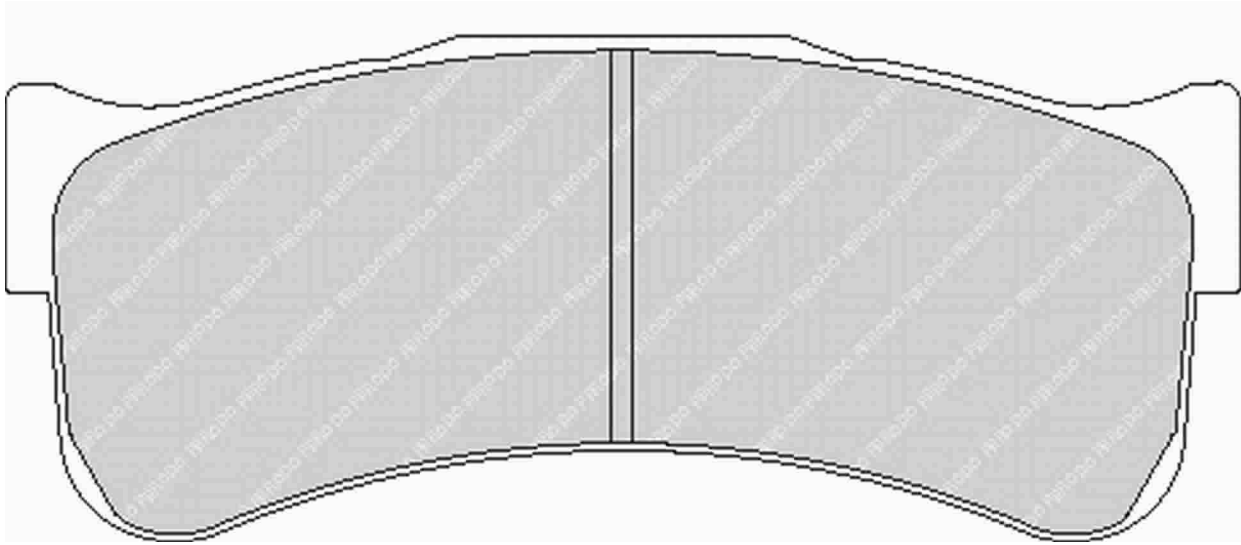

ALSO AVAILABLE		
SHAPE	TH. MM	NOTES
FRP3110	25	
FRP3123	21.5	

MATERIAL AVAILABILITY						
H	C	R	W	WB	Z	ZB

CROSS REFERENCE	
BREMBO	07.7293.6
BREMBO	07.7293.60
BREMBO	07.7293.61
BREMBO	07.7293.63
BREMBO	07.7293.70
PAGID	2488
PFC	7797.XX.29

FRP3032

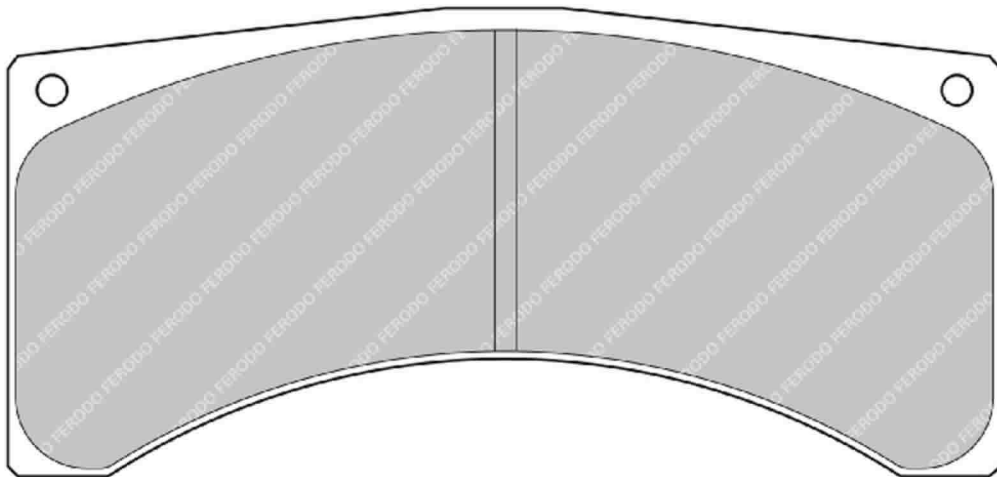
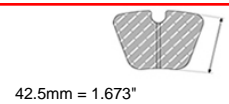
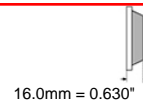
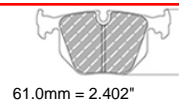
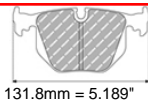

ALSO AVAILABLE		
SHAPE	TH. MM	NOTES
FRP3070	18	

MATERIAL AVAILABILITY						
H	C	R	W	WB	Z	ZB
		✓			✉	

CROSS REFERENCE	
BREMBO	07.5139
BREMBO	07.5139.85
BREMBO	07.5139.88
PFC	7718.XX.16

FRP3033

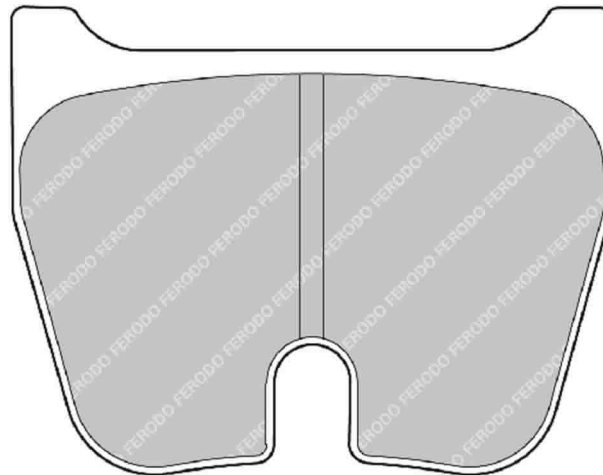
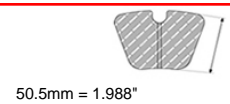
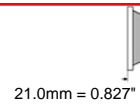
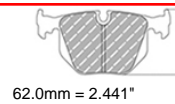
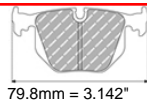

ALSO AVAILABLE		
SHAPE	TH. MM	NOTES
FRP3022	20	
FRP3023	17.5	

MATERIAL AVAILABILITY						
H	C	R	W	WB	Z	ZB

CROSS REFERENCE	
BREMBO	07.5684.8
BREMBO	07.5684.80
BREMBO	07.5684.81
PFC	7743.XX.21

FRP3034



84.8mm = 3.339"



68.0mm = 2.677"



21.0mm = 0.827"

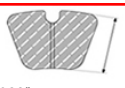

51.5mm = 2.028"

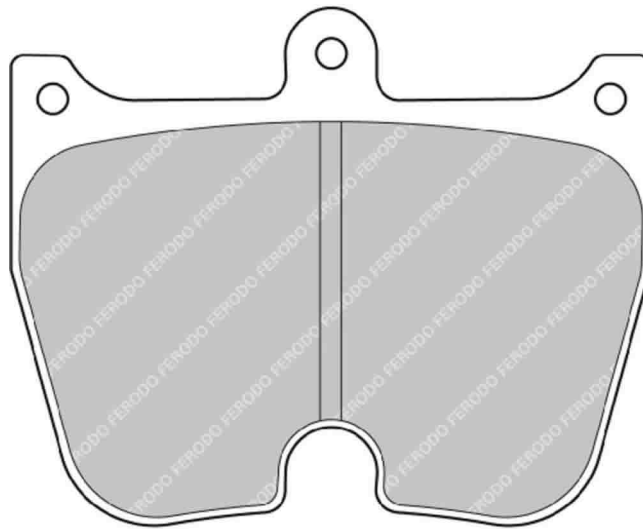

4 Pistons caliper

(1 set = 4 pads) - 2 sets per axle for the recommended applications

ALSO AVAILABLE

SHAPE	TH. MM	NOTES
FRP1059	22	
FRP3004	20	
FRP3045	18	

CROSS REFERENCE

BREMBO	07.7810.2
BREMBO	07.7810.20
BREMBO	07.7810.21
PFC	7742.XX.21

MATERIAL AVAILABILITY

H	C	R	W	WB	Z	ZB

FRP3035

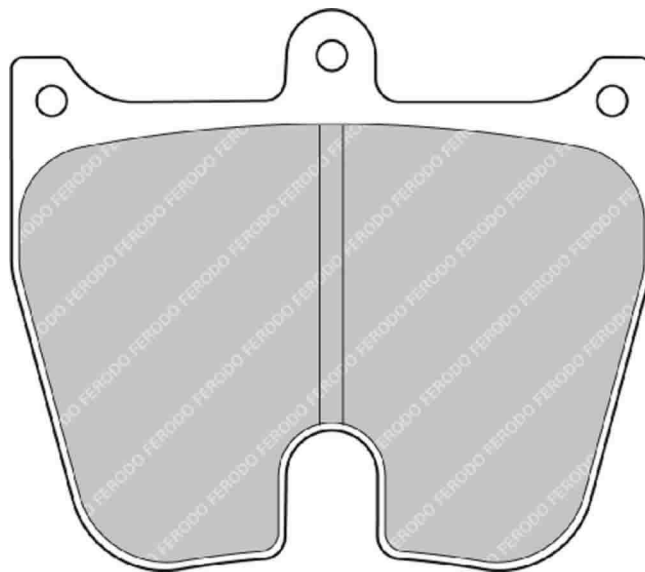
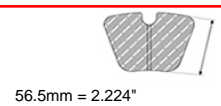
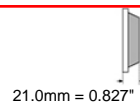
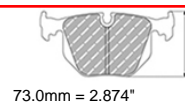
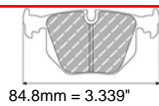

4 Pistons caliper (1 set = 4 pads) - 2 sets per axle for the recommended applications

MATERIAL AVAILABILITY						
H	C	R	W	WB	Z	ZB

CROSS REFERENCE	
BREMBO	07.7810.1
BREMBO	07.7810.10
BREMBO	07.7810.11

FRP3037



163.1mm = 6.421"



69.0mm = 2.717"



28.0mm = 1.102"

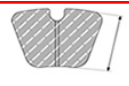

54.0mm = 2.126"

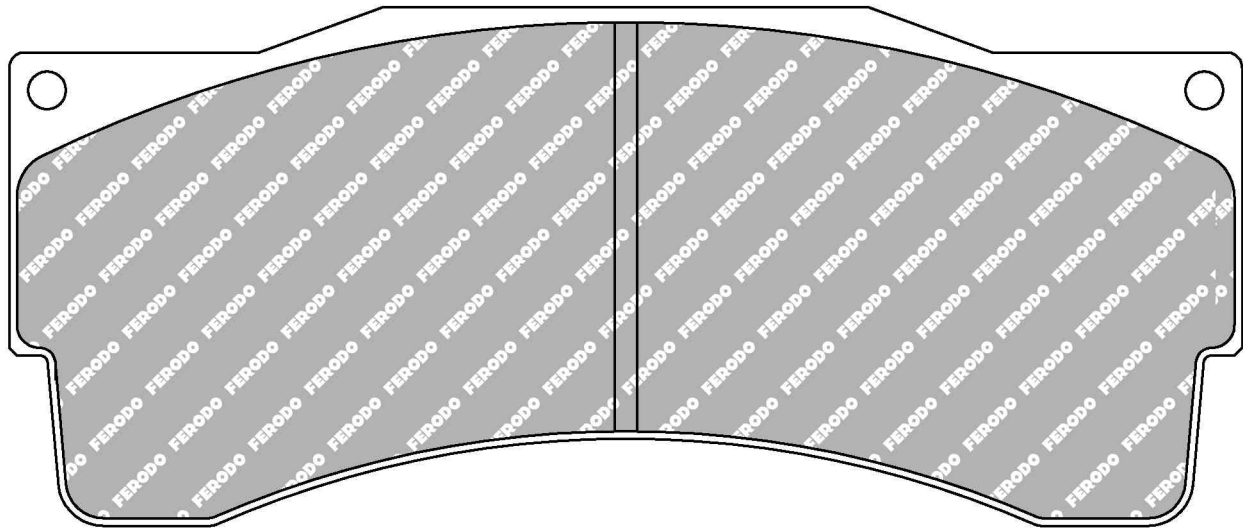

ALSO AVAILABLE		
SHAPE	TH. MM	NOTES
FRP3039	25	
FRP3055	30	

MATERIAL AVAILABILITY						
H	C	R	W	WB	Z	ZB

CROSS REFERENCE	
ALCON	PNF4495X514.4
ALCON	PNF4495X516.4
AP RACING	CP6210D54 (28 mm)
PAGID	2557
PFC	7778.XX.28

- Available
- Exhausting
- Out of Range
- Make to order
- In Introduction

FRP3039



163.1mm = 6.421"



69.0mm = 2.717"



25.0mm = 0.984"

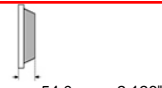

54.0mm = 2.126"

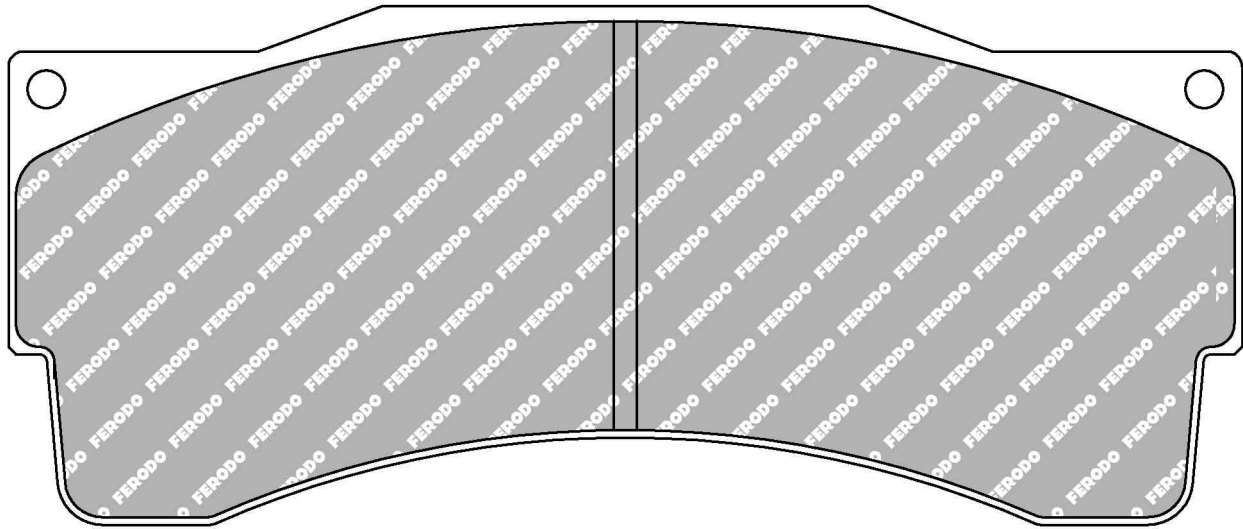

ALSO AVAILABLE		
SHAPE	TH. MM	NOTES
FRP3037	28	
FRP3055	30	

MATERIAL AVAILABILITY						
H	C	R	W	WB	Z	ZB

CROSS REFERENCE	
ALCON	PNF4495X501.4
AP RACING	CP6230D54 (25 mm)
PAGID	2688
PAGID	8222
PFC	7778.XX.25

FRP3040



163.9mm = 6.453"



66.0mm = 2.598"



30.0mm = 1.181"

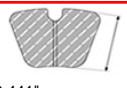

62.0mm = 2.441"

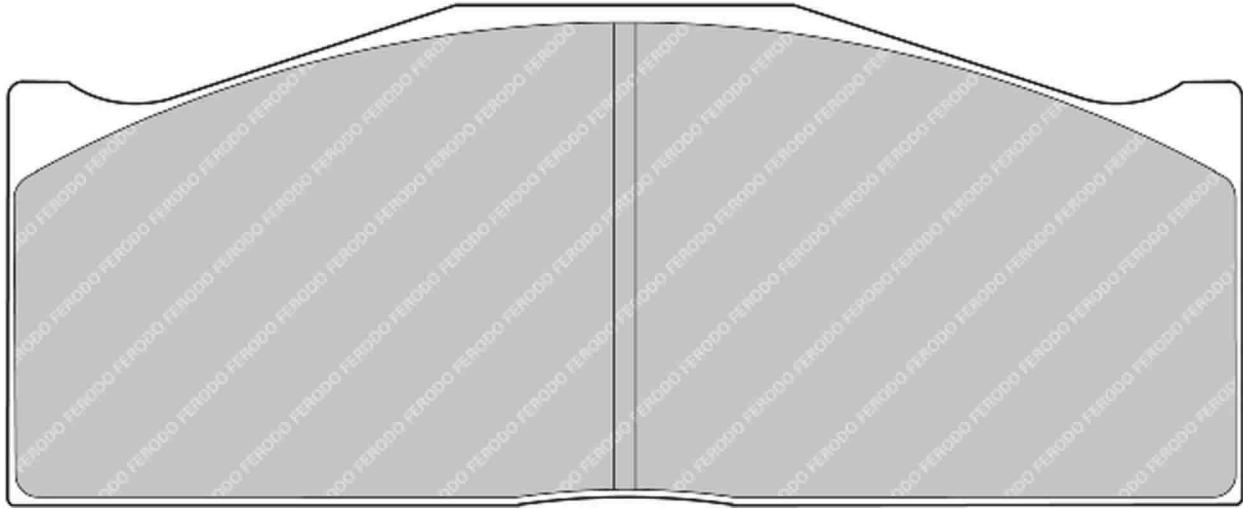

MATERIAL AVAILABILITY

H	C	R	W	WB	Z	ZB

CROSS REFERENCE

BREMBO	07.7614.2
BREMBO	07.7614.20
BREMBO	07.7614.21
PAGID	2016
PFC	7773.XX.30

Available
 Exhausting
 Out of Range
 Make to order
 In Introduction

FRP3042



131.8mm = 5.189"



75.0mm = 2.953"



26.5mm = 1.043"

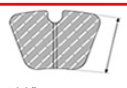

66.0mm = 2.598"

PORSCHE Front

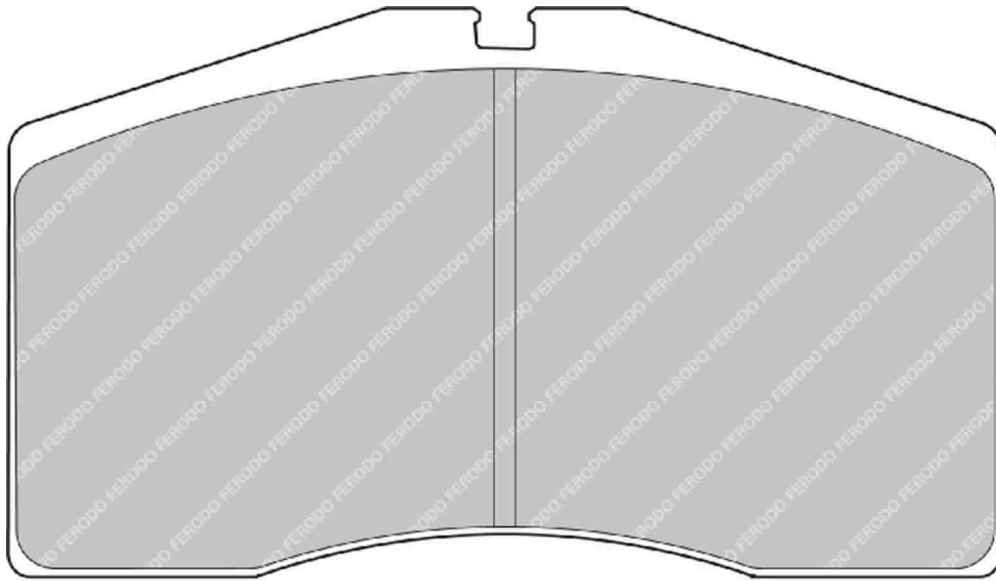

ALSO AVAILABLE		
SHAPE	TH. MM	NOTES
FCP891	17.5	

MATERIAL AVAILABILITY						
H	C	R	W	WB	Z	ZB
		✓	✓			

CROSS REFERENCE	
BREMBO	07.5308.9
BREMBO	07.5308.91
PAGID	1908
PAGID	2703

FRP3043



132.1mm = 5.201"

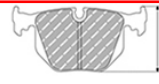

58.0mm = 2.283"



17.0mm = 0.669"



46.5mm = 1.831"

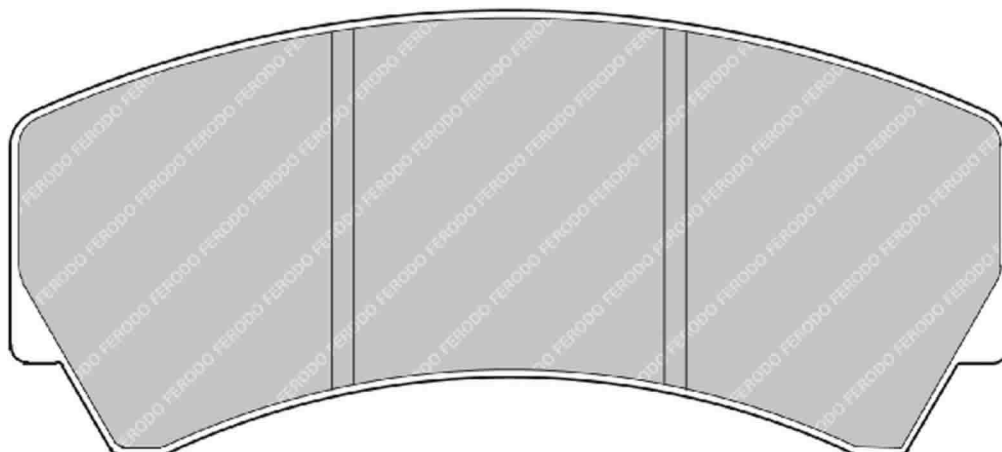

MATERIAL AVAILABILITY						
H	C	R	W	WB	Z	ZB
		✓			✉	

CROSS REFERENCE	
ALCON	PNF3430X275.4

3278

FRP3044

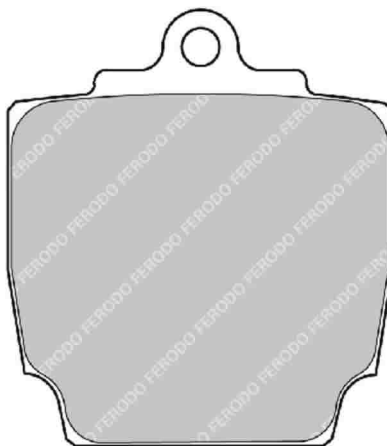
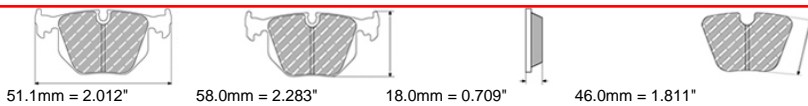

MATERIAL AVAILABILITY						
H	C	R	W	WB	Z	ZB
		✓			✉	

CROSS REFERENCE	
ALCON	PNF4493X603
ALCON	PNF4493X603.12
ALCON	PNF4493X603.4
ALCON	PNF4493X610.12
ALCON	PNF4493X610.4

- ✓ Available
- ✗ Out of Range
- ✉ In Introduction
- ⚠ Exhausting
- ✉ Make to order

FRP3045



84.8mm = 3.339"



68.0mm = 2.677"



18.0mm = 0.709"

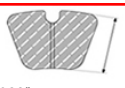

51.5mm = 2.028"

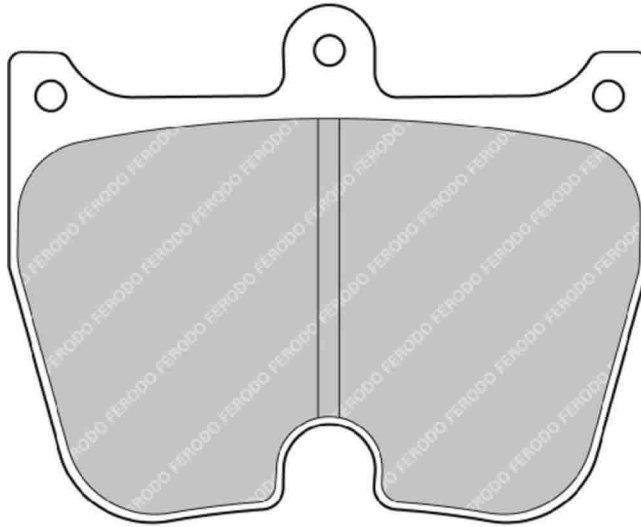

4 Pistons caliper

(1 set = 4 pads) - 2 sets per axle for the recommended applications

ALSO AVAILABLE

SHAPE	TH. MM	NOTES
FRP1059	22	
FRP3004	20	
FRP3034	21	

MATERIAL AVAILABILITY

H	C	R	W	WB	Z	ZB

CROSS REFERENCE

BREMBO	07.7810.3
BREMBO	07.7810.30
BREMBO	07.7810.31
PFC	7742.XX.18
PFC	7802.XX.18

FRP3046



163.9mm = 6.453"

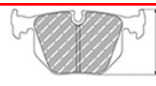

76.0mm = 2.992"



30.0mm = 1.181"



62.0mm = 2.441"

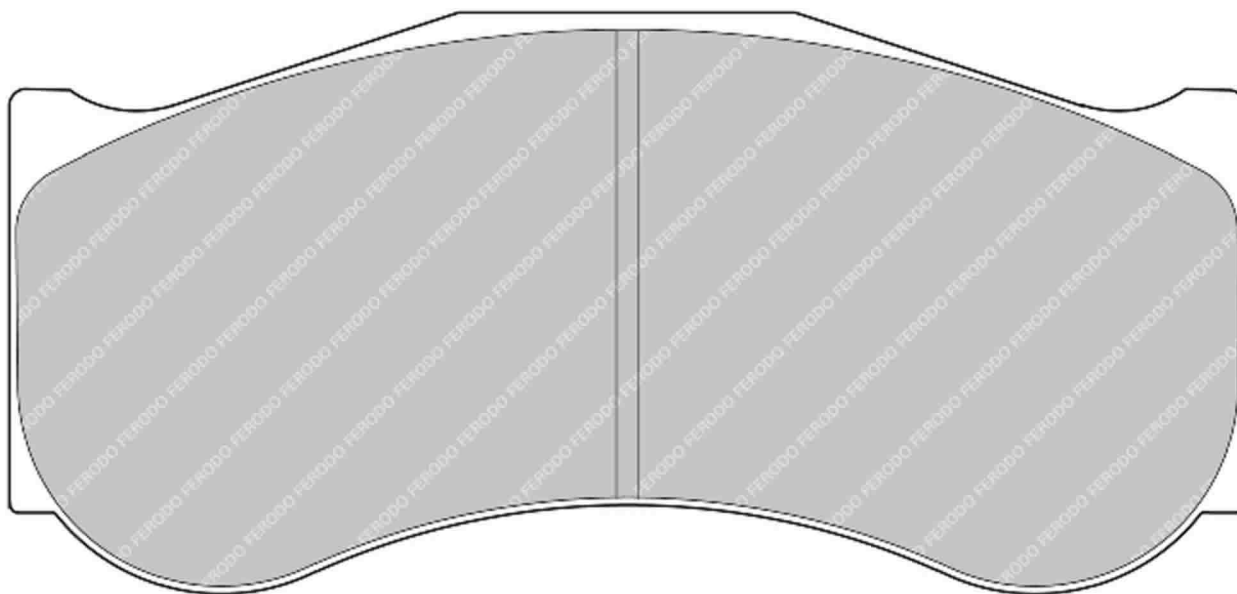

MATERIAL AVAILABILITY

H	C	R	W	WB	Z	ZB
			✓			

CROSS REFERENCE

BREMBO	07.7614.3
BREMBO	07.7614.30
BREMBO	07.7614.31
PAGID	2017

✓ Available ⚠ Exhausting
 ✗ Out of Range 📦 Make to order
 📅 In Introduction

FRP3050

WVA No: 23139 17,00



140.0mm = 5.512"



88.0mm = 3.465"



17.0mm = 0.669"



61.6mm = 2.425"

PORSCHE Front

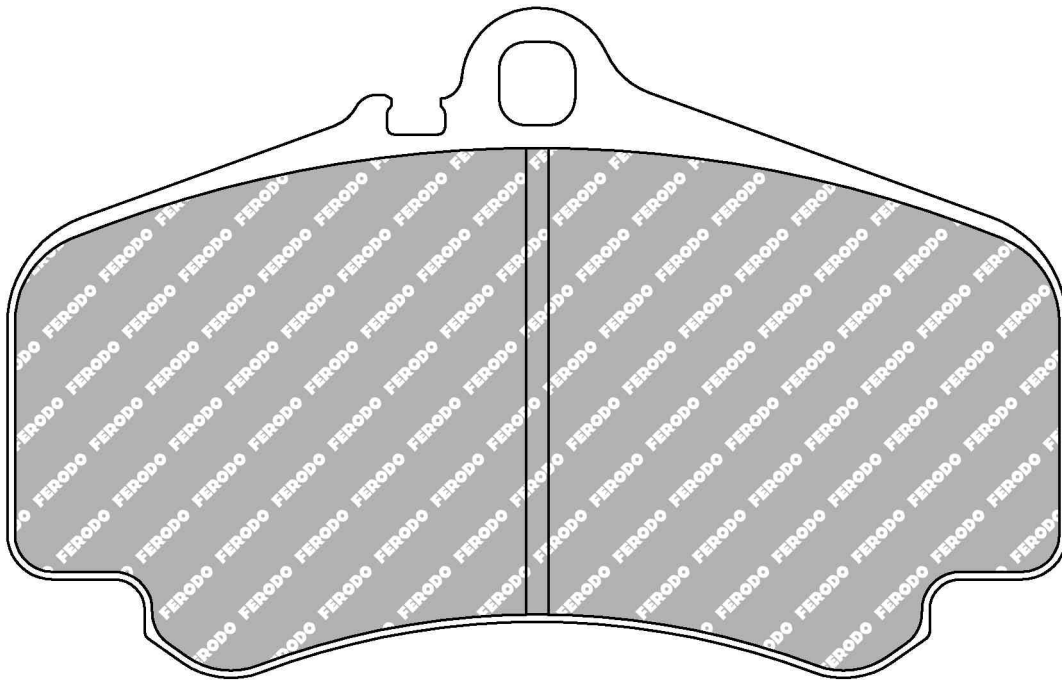

MATERIAL AVAILABILITY

H	C	R	W	WB	Z	ZB
✓		✓	✓			

CROSS REFERENCE

MINTEX	MDB2039
PAGID	2474
PAGID	T1291
PFC	7818.XX.17
WVA	23139 17,00

FRP3051

WVA No: 23329

FMSI No: D776

PORSCHE Front / Rear



121.0mm = 4.764"



85.0mm = 3.346"



16.8mm = 0.661"



59.0mm = 2.323"

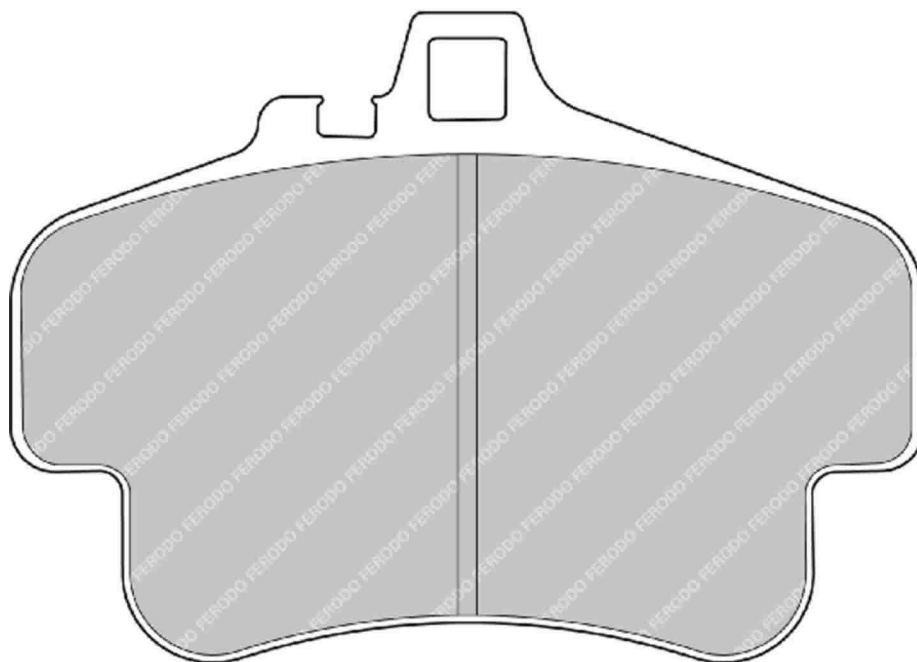

MATERIAL AVAILABILITY						
H	C	R	W	WB	Z	ZB
✓		✓	✓			

CROSS REFERENCE	
FMSI	D776
HAWK	HB291 0,642
MINTEX	MDB2417
MINTEX	MDB2842
PAGID	2405
PAGID	8236
PAGID	T1231
PAGID	T1635
PAGID	T1799
PFC	0776
WVA	23329

✓ Available ⚠ Exhausting
 ✗ Out of Range 📦 Make to order
 📅 In Introduction

FRP3053



139.8mm = 5.504"

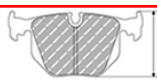

80.0mm = 3.150"



27.5mm = 1.083"

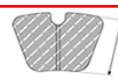

61.0mm = 2.402"

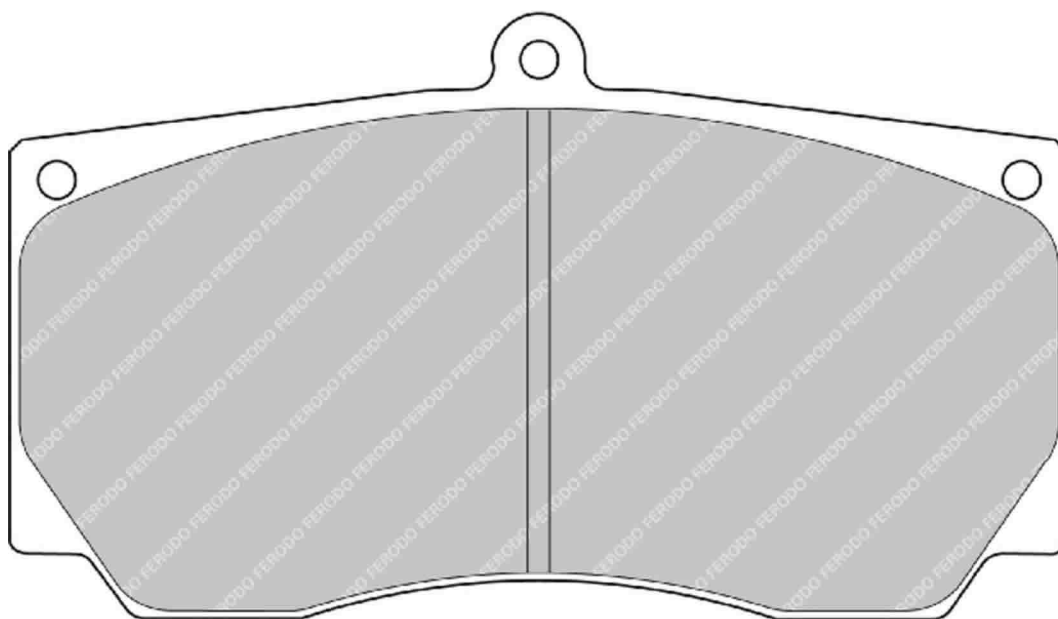

MATERIAL AVAILABILITY

H	C	R	W	WB	Z	ZB

CROSS REFERENCE

BREMBO	07.6955.3
BREMBO	07.6955.30
BREMBO	07.6955.31
PFC	7775.XX.28

FRP3054

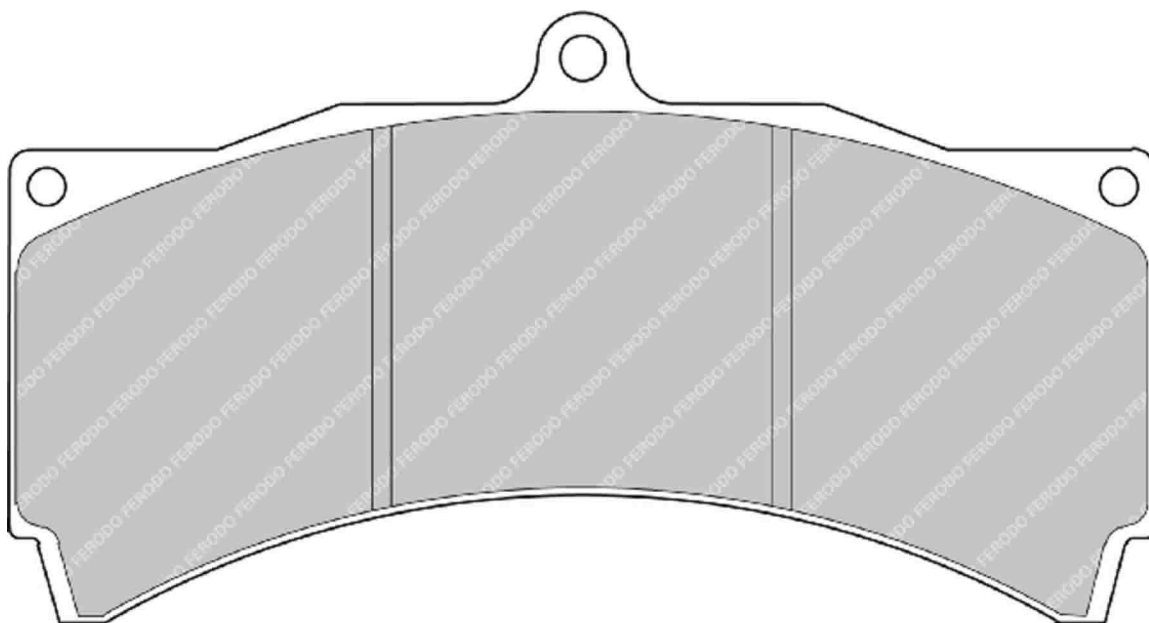
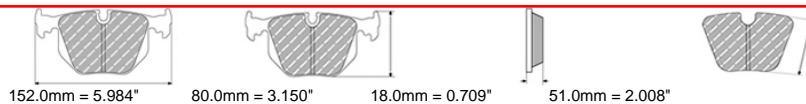

ALSO AVAILABLE		
SHAPE	TH. MM	NOTES
FRP3061	25	
FRP3076	17	

CROSS REFERENCE	
ALCON	PNF4489X545.4
AP RACING	CP3894D51 (18 mm)
PAGID	1903
PFC	7793.XX.18

MATERIAL AVAILABILITY						
H	C	R	W	WB	Z	ZB
✓		✓	✓		✓	

✓ Available ⚠ Exhausting
 ✗ Out of Range 📦 Make to order
 ⓘ In Introduction

FRP3055



163.1mm = 6.421"

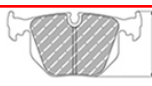

69.0mm = 2.717"



30.0mm = 1.181"

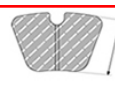

54.0mm = 2.126"

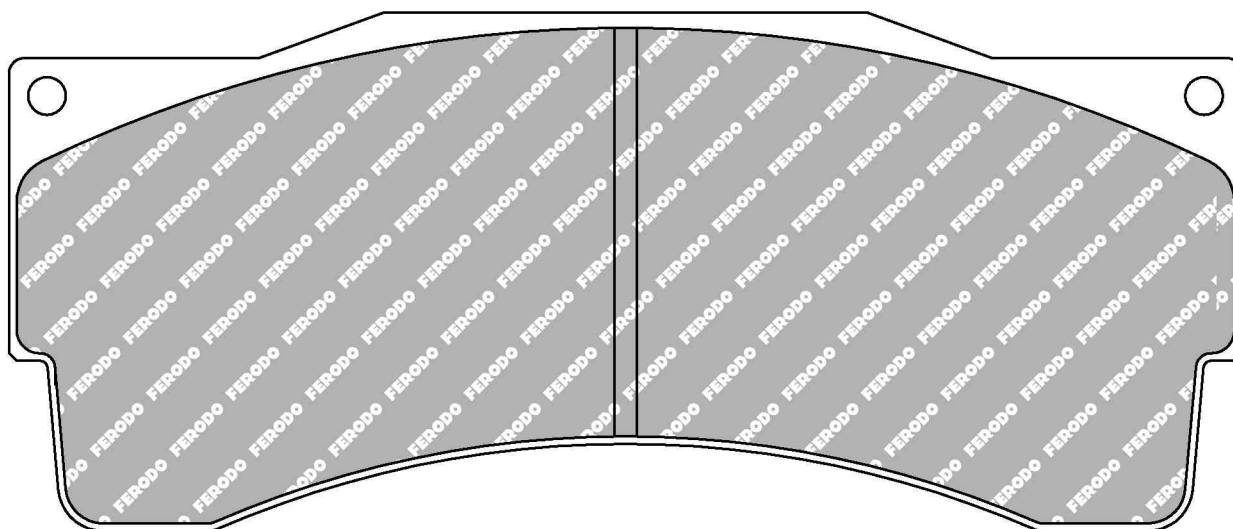

ALSO AVAILABLE		
SHAPE	TH. MM	NOTES
FRP3037	28	
FRP3039	25	

MATERIAL AVAILABILITY						
H	C	R	W	WB	Z	ZB

CROSS REFERENCE	
ALCON	PNF4495X517.4
ALCON	PNF4495X518.4
AP RACING	CP6210D54 (30 mm)
PAGID	2558
PAGID	2559
PFC	7778.XX.30

FRP3056

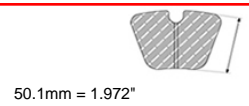
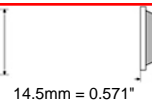
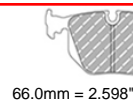
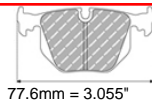

LOTUS Front, RENAULT Rear

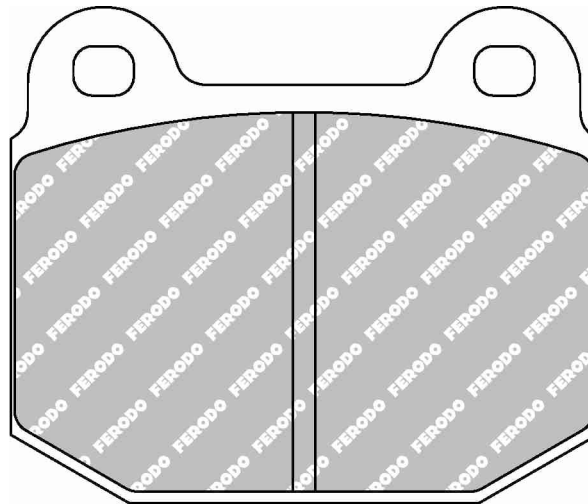

ALSO AVAILABLE		
SHAPE	TH. MM	NOTES
FCP116	16.5	
FCP1562		different friction area

CROSS REFERENCE	
AP RACING	CP5119D50
PFC	0109-07-16-44

MATERIAL AVAILABILITY						
H	C	R	W	WB	Z	ZB
✓	✓	✓			✉	

✓ Available ⚠ Exhausting
 ✗ Out of Range ✉ Make to order
 ⓘ In Introduction

FRP3057



183.2mm = 7.213"
197.3mm = 7.768"



66.0mm = 2.598"
59.0mm = 2.323"



16.0mm = 0.630"
13.6mm = 0.535"

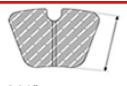

46.0mm = 1.811"
46.0mm = 1.811"

FMSI No: D052

BUICK Front / Rear, CADILLAC Front, CHEVROLET Front, JEEP Front, OLDSMOBILE Front, PONTIAC Front

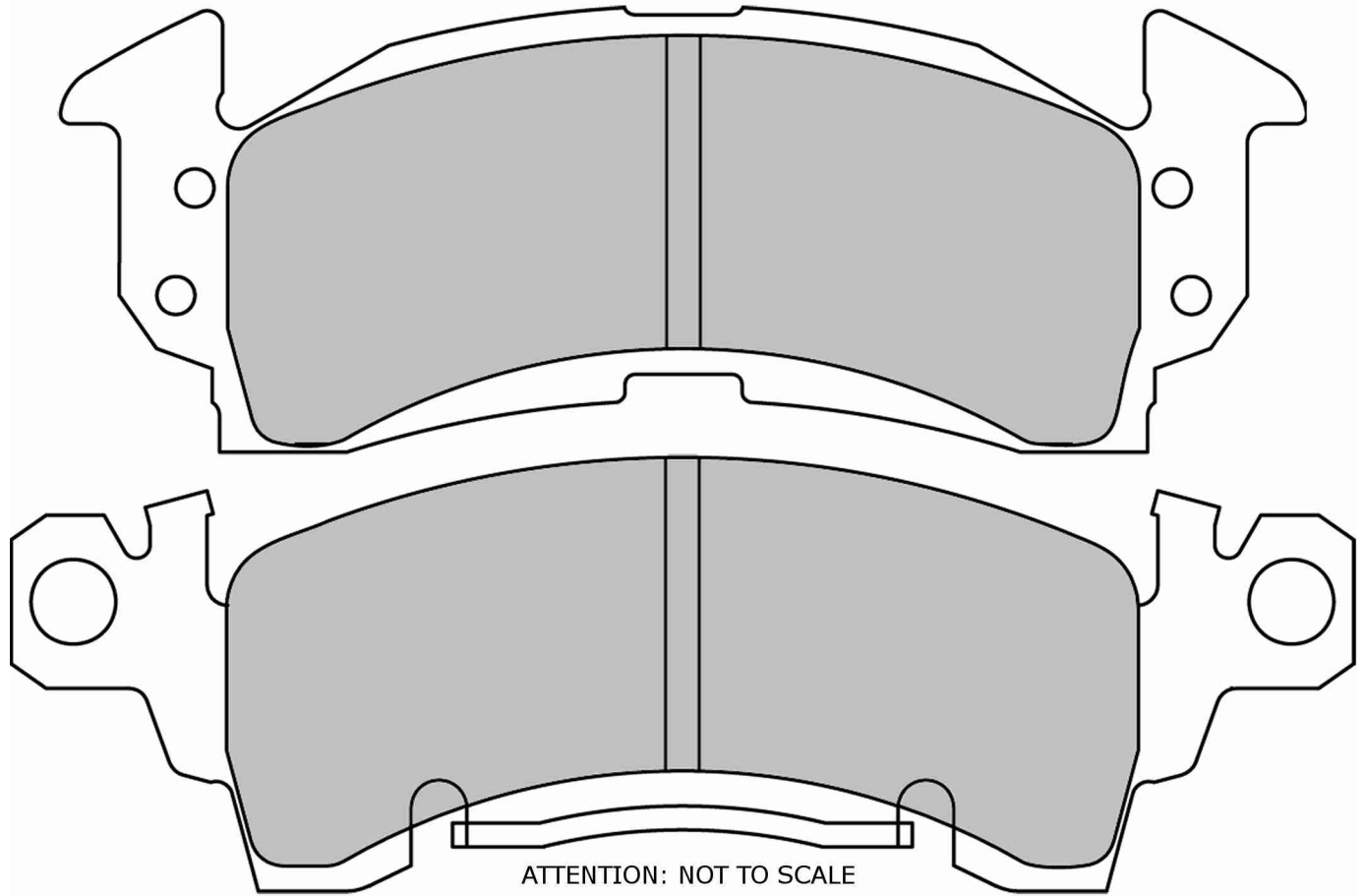

MATERIAL AVAILABILITY						
H	C	R	W	WB	Z	ZB
✓		✉	✓		✓	

CROSS REFERENCE	
FMSI	D052
FMSI	D313
HAWK	HB103 0,59
MINTEX	MTX1594
PAGID	1594USA
PFC	0052.XX

FRP3058



152.0mm = 5.984"
123.1mm = 4.846"



73.0mm = 2.874"
66.0mm = 2.598"



16.0mm = 0.630"
14.0mm = 0.551"

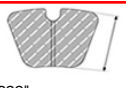

41.2mm = 1.622"
41.2mm = 1.622"

FMSI No: D154

CHEVROLET Front / Rear, PONTIAC Front / Rear

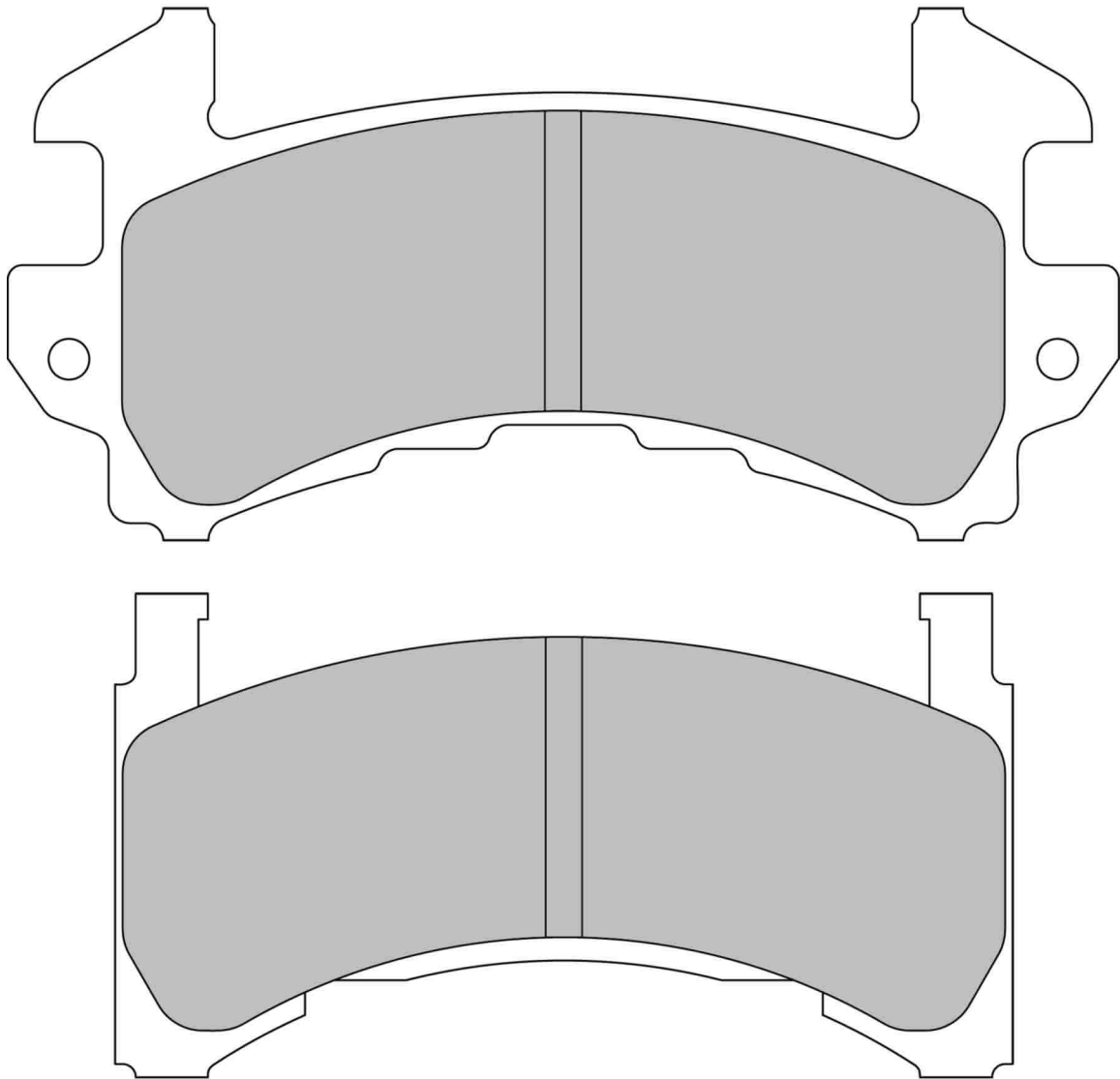

MATERIAL AVAILABILITY						
H	C	R	W	WB	Z	ZB
✗		✓	⚠		✉	

CROSS REFERENCE	
FMSI	D154
FMSI	D202
HAWK	HB119 0,594
MINTEX	MTX1595
PAGID	1595USA
PFC	0154.XX

✓ Available ⚠ Exhausting
 ✗ Out of Range ✉ Make to order
 ⓘ In Introduction

FRP3059

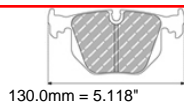

130.0mm = 5.118"



82.0mm = 3.228"

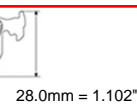

28.0mm = 1.102"



66.0mm = 2.598"

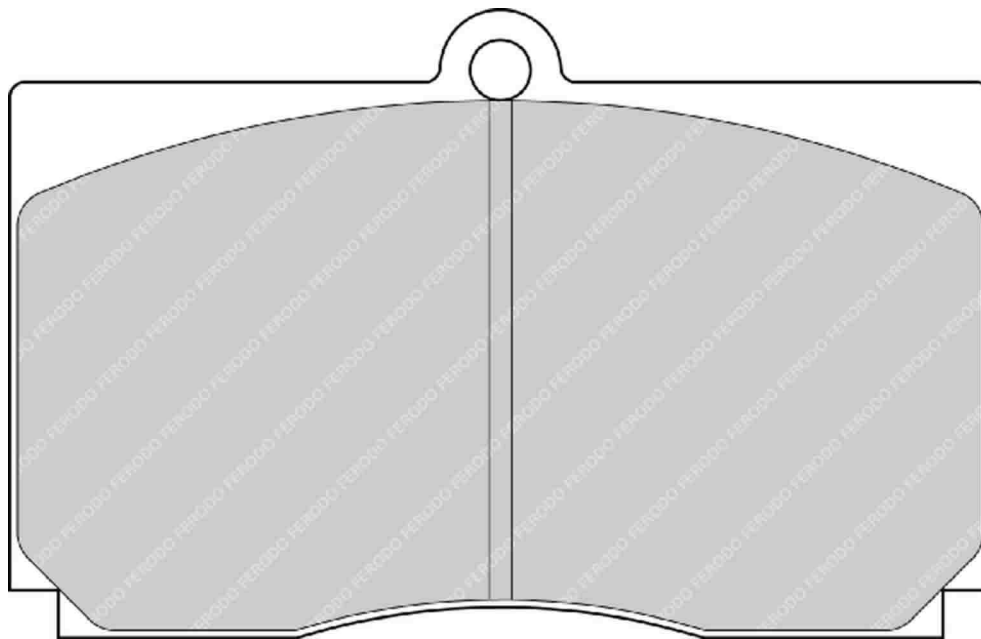

MATERIAL AVAILABILITY						
H	C	R	W	WB	Z	ZB
		✓	✗			

CROSS REFERENCE	
AP RACING	CP2749D66 (28 mm)
PAGID	1218
PFC	7702

FRP3060

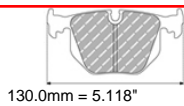

130.0mm = 5.118"

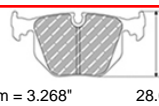

83.0mm = 3.268"

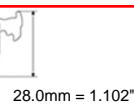

28.0mm = 1.102"



54.0mm = 2.126"

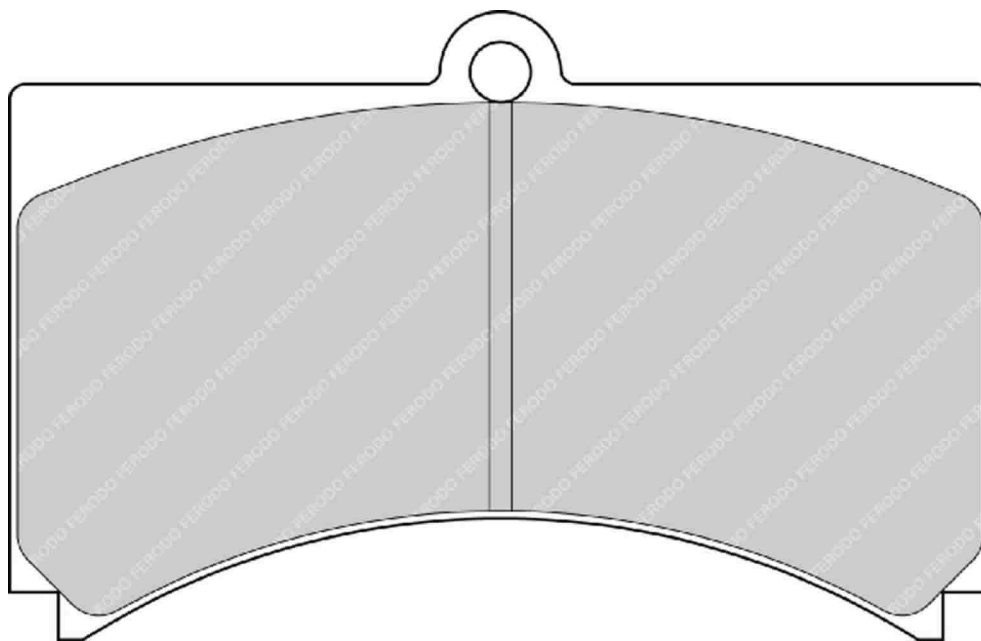

MATERIAL AVAILABILITY						
H	C	R	W	WB	Z	ZB
		✗	✓			

CROSS REFERENCE	
AP RACING	CP2749D55 (28 mm)
PFC	7712

- ✓ Available
- ✗ Out of Range
- ⓘ In Introduction
- ⚠ Exhausting
- 📦 Make to order

FRP3061



152.0mm = 5.984"



80.0mm = 3.150"



25.0mm = 0.984"

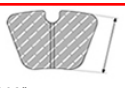

51.0mm = 2.008"

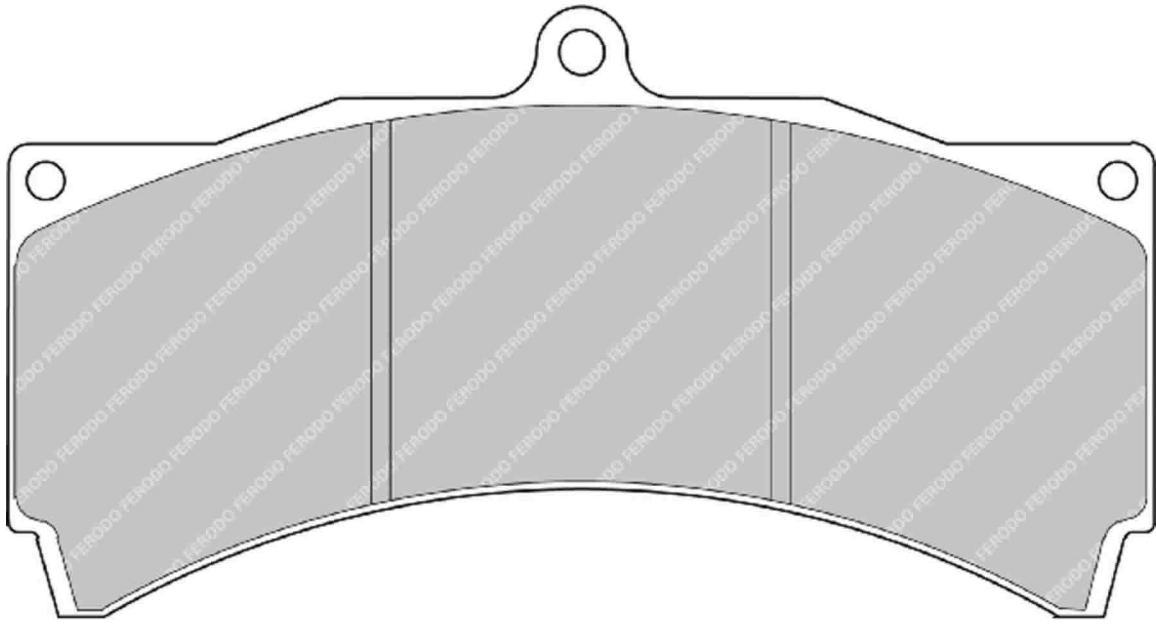

ALSO AVAILABLE

SHAPE	TH. MM	NOTES
FRP3054	18	
FRP3076	17	

CROSS REFERENCE

AP RACING	CP3558D51
PAGID	1538
PFC	7790.XX.25

MATERIAL AVAILABILITY

H	C	R	W	WB	Z	ZB

FRP3062



148.8mm = 5.858"



57.0mm = 2.244"



19.5mm = 0.768"



50.5mm = 1.988"

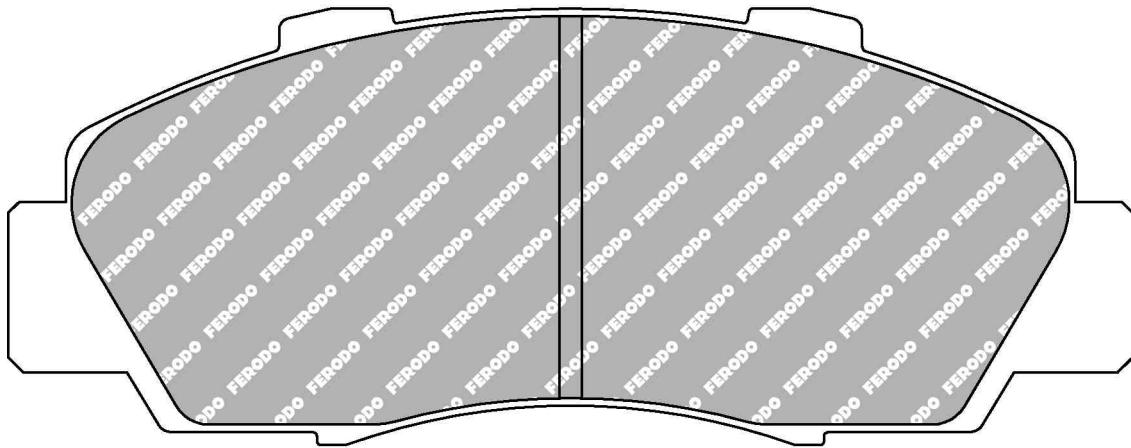

ALSO AVAILABLE

SHAPE	TH. MM	NOTES
FCP905	18.5	

MATERIAL AVAILABILITY

H	C	R	W	WB	Z	ZB

- Available
- Out of Range
- In Introduction
- Exhausting
- Make to order

FRP3067

WVA No: 23092 15,00

FMSI No: D1001

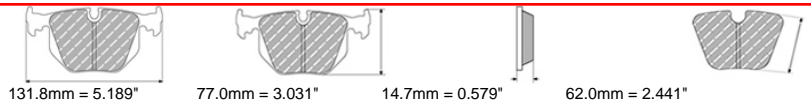

ALFA ROMEO Front, ASTON MARTIN Front, HONDA Front, SUBARU Front, TESLA Front

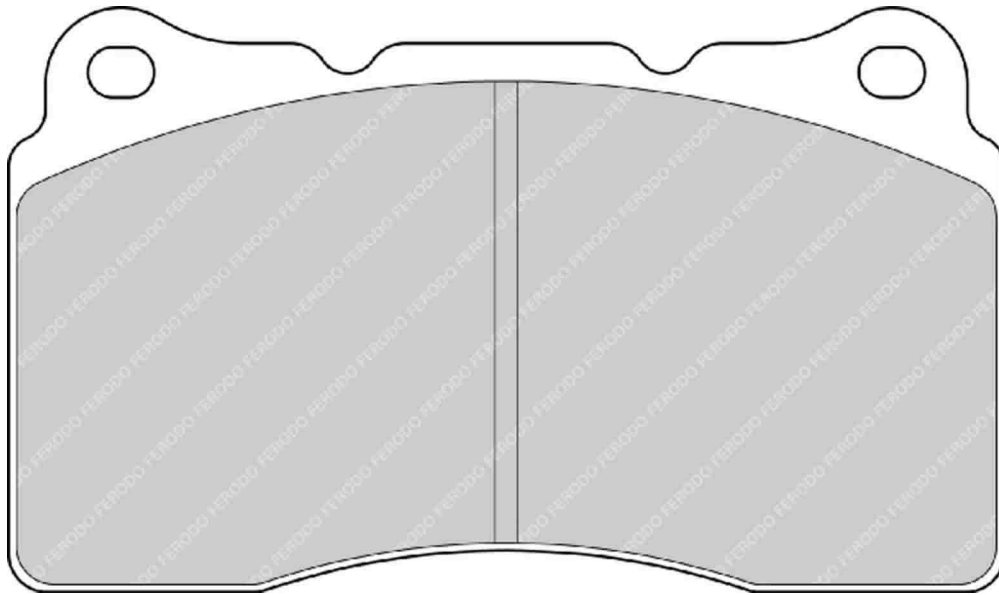

ALSO AVAILABLE

SHAPE	TH. MM	NOTES
FCP1334	16	

MATERIAL AVAILABILITY

H	C	R	W	WB	Z	ZB
✓		✓	✓		✉	

CROSS REFERENCE

ALCON	PNF0084X336.4
BREMBO	07.8301.84
BREMBO	07.8715.36
FMSI	D1001
HAWK	HB453 0,585
MINTEX	MDB2592
PAGID	T1830
PFC	7781
WVA	23092 15,00

FRP3069

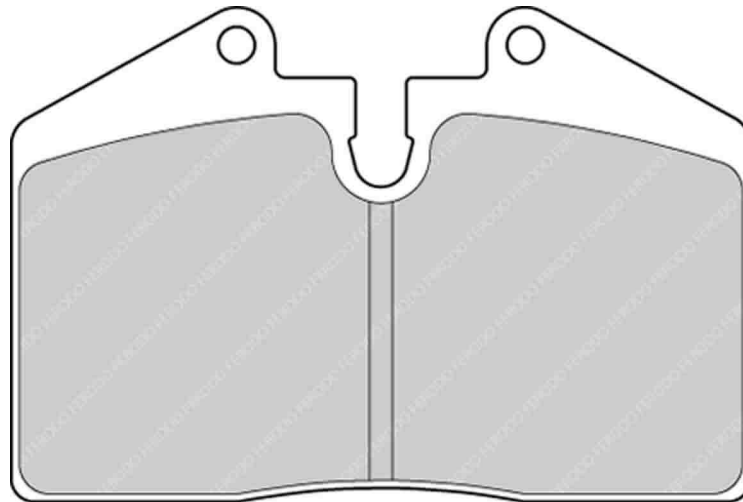
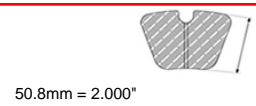
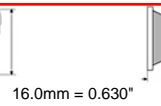
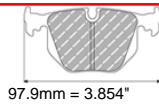

ALSO AVAILABLE		
SHAPE	TH. MM	NOTES
FCP451	18	

CROSS REFERENCE	
ALCON	PNF4436X509
ALCON	PNF4436X509.4
PAGID	8009

MATERIAL AVAILABILITY						
H	C	R	W	WB	Z	ZB
✓		✓	✉		✉	

FRP3070

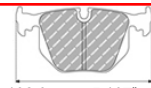

132.0mm = 5.197"



61.0mm = 2.402"



18.0mm = 0.709"



42.5mm = 1.673"

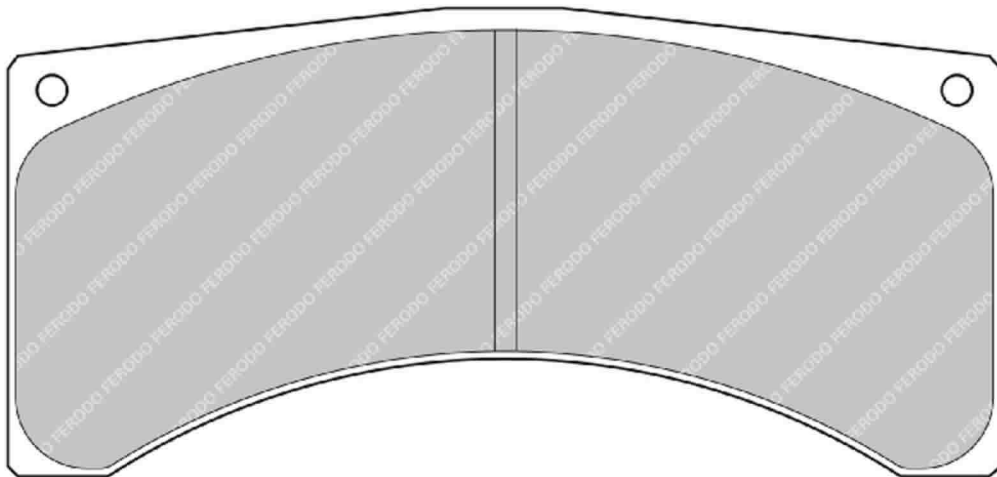

ALSO AVAILABLE

SHAPE	TH. MM	NOTES
FRP3032	16	

CROSS REFERENCE

BREMBO	07.7869.12
PFC	7718.XX.18

MATERIAL AVAILABILITY

H	C	R	W	WB	Z	ZB
		✓	✓		✉	

FRP3071



100.0mm = 3.937"



46.0mm = 1.811"



16.0mm = 0.630"



37.0mm = 1.457"

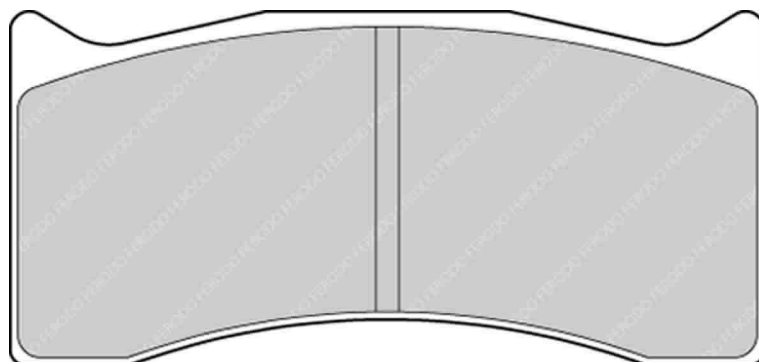

MATERIAL AVAILABILITY

H	C	R	W	WB	Z	ZB
✉	✓	✓	✓		✓	

CROSS REFERENCE

PAGID	8000
PFC	7736

FRP3073



132.4mm = 5.213"



55.0mm = 2.165"

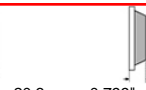

20.3mm = 0.799"

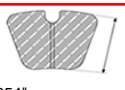

42.0mm = 1.654"

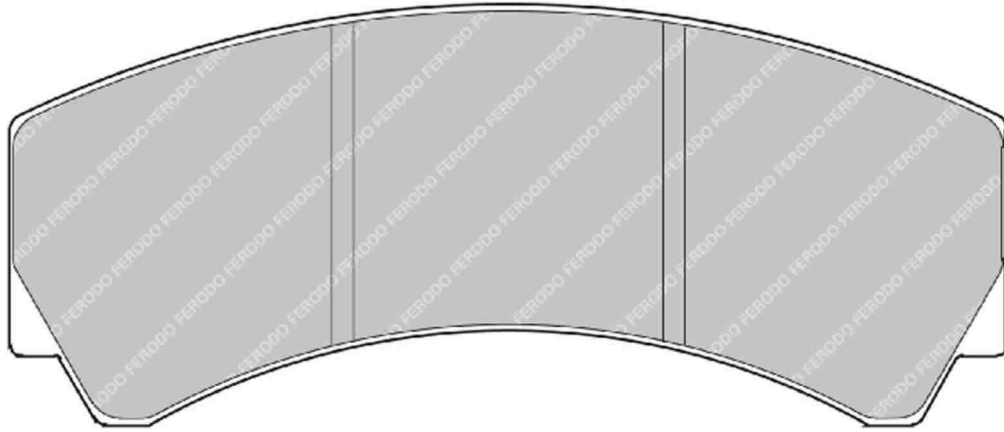

ALSO AVAILABLE		
SHAPE	TH. MM	NOTES
FRP3018	16.7	

CROSS REFERENCE	
AP RACING	CP2279D42
PFC	7768.XX.20

MATERIAL AVAILABILITY						
H	C	R	W	WB	Z	ZB
		✓				

FRP3074



58.1mm = 2.287"



59.0mm = 2.323"



18.0mm = 0.709"



47.9mm = 1.886"

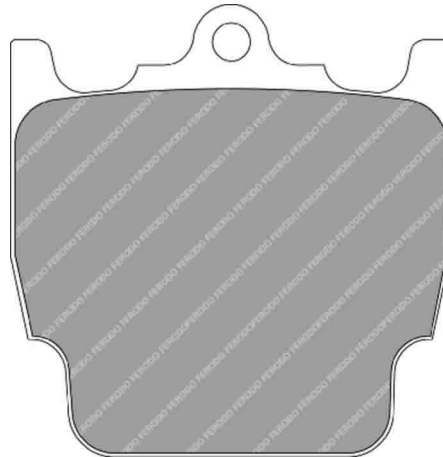

MATERIAL AVAILABILITY						
H	C	R	W	WB	Z	ZB
		✓				

CROSS REFERENCE	
PFC	7746
PFC	7750.XX.20

✓ Available ⚠ Exhausting
 ✗ Out of Range 📦 Make to order
 ⓘ In Introduction

FRP3075



190.4mm = 7.496"



101.0mm = 3.976"



17.5mm = 0.689"

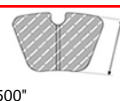

63.5mm = 2.500"

FMSI No: D991

PORSCHE Front

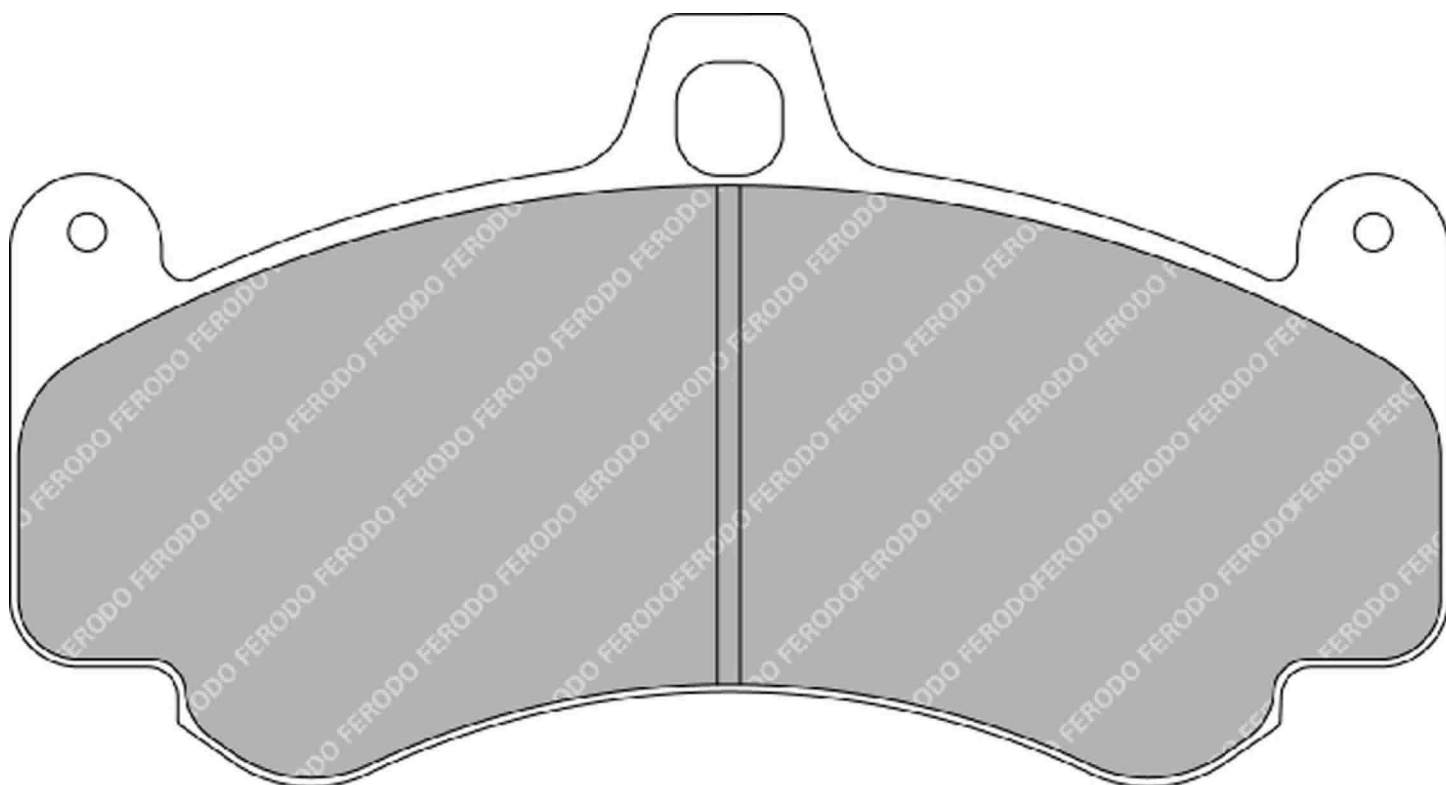

ALSO AVAILABLE		
SHAPE	TH. MM	NOTES
FRP3096	19	

MATERIAL AVAILABILITY						
H	C	R	W	WB	Z	ZB
✓			✓		✗	✉

CROSS REFERENCE	
FMSI	D991
HAWK	HB483 0,635
MINTEX	MDB3033
PAGID	2707
PAGID	8003
PAGID	T1857
PFC	7819

FRP3076

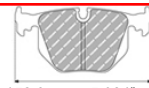

152.0mm = 5.984"



80.0mm = 3.150"



17.0mm = 0.669"

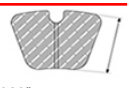

50.0mm = 1.969"

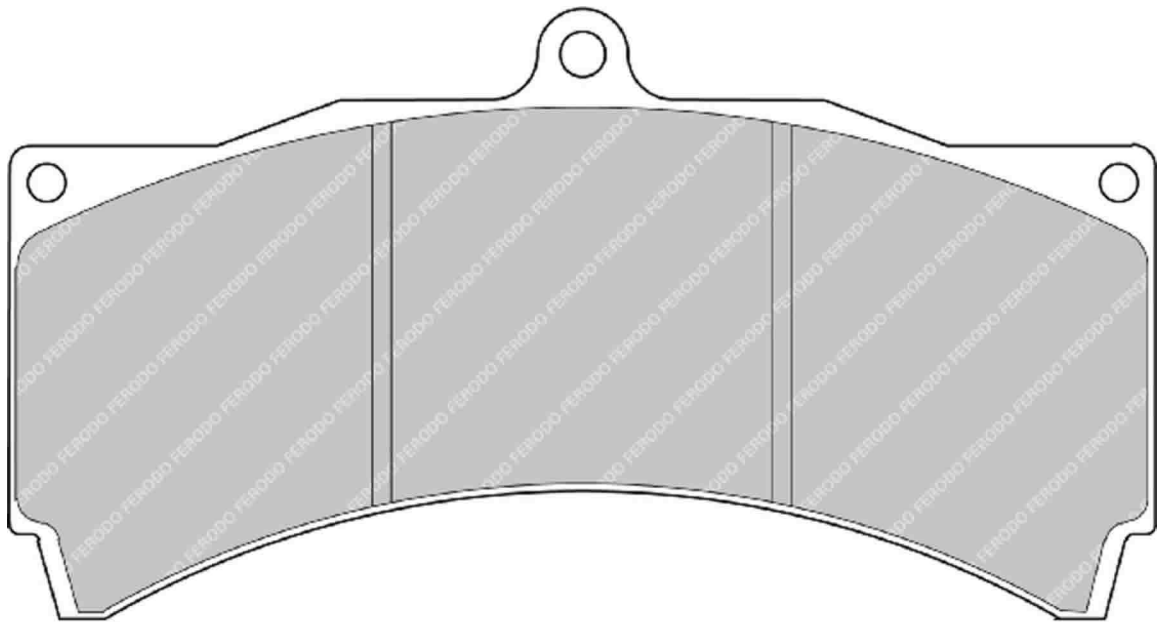

ALSO AVAILABLE

SHAPE	TH. MM	NOTES
FRP3054	18	
FRP3061	25	

CROSS REFERENCE

AP RACING	CP5070D51
PAGID	8018

MATERIAL AVAILABILITY

H	C	R	W	WB	Z	ZB
✓		✓			✉	

FRP3077

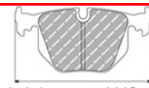

152.1mm = 5.988"



80.0mm = 3.150"



17.0mm = 0.669"

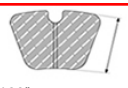

54.0mm = 2.126"

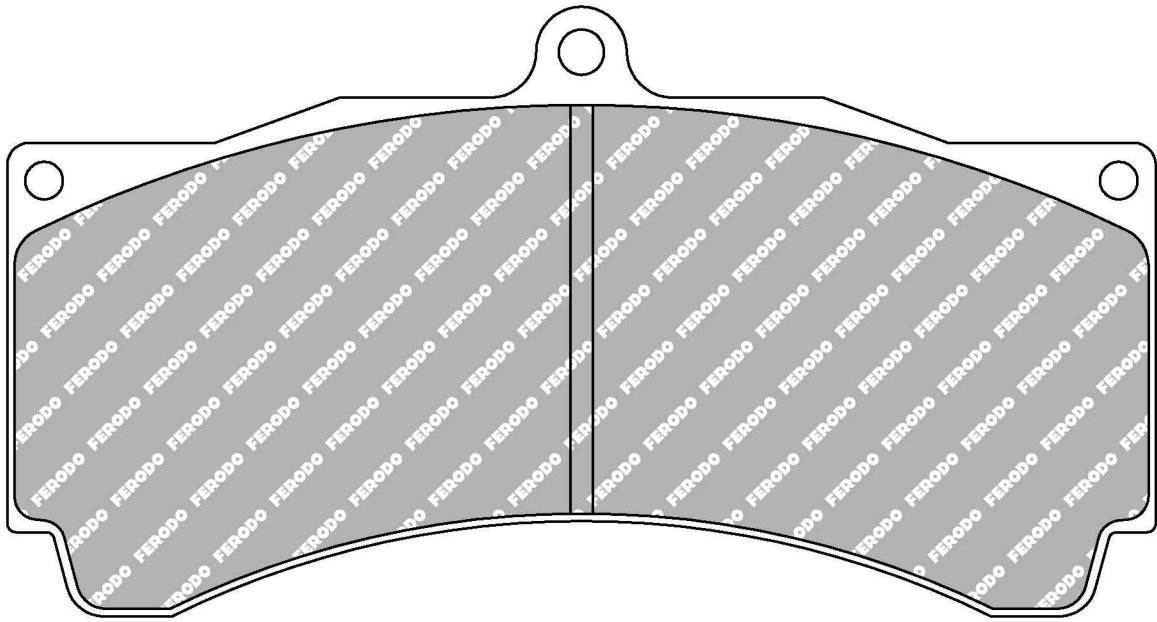

ALSO AVAILABLE

SHAPE	TH. MM	NOTES
FRP3003	18	with top tab
FRP3014	25	without top tab
FRP3015	28.5	without top tab
FRP3144	18	without top tab
FRP3145	17	without top tab

CROSS REFERENCE

AP RACING	CP5070D54
PFC	7790.XX.17

MATERIAL AVAILABILITY

H	C	R	W	WB	Z	ZB
✓		✓	✓		✗	

FRP3078

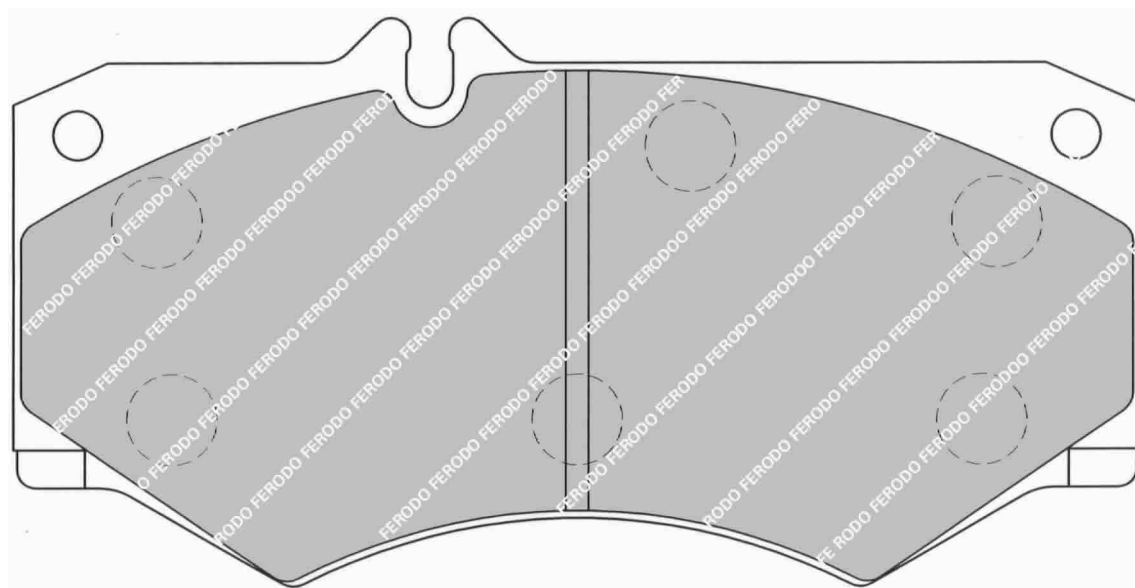
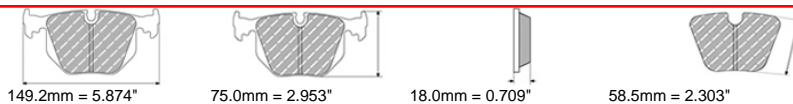

MATERIAL AVAILABILITY						
H	C	R	W	WB	Z	ZB

CROSS REFERENCE	
EBC	DP4413R
TAROX	SP0239

FRP3080

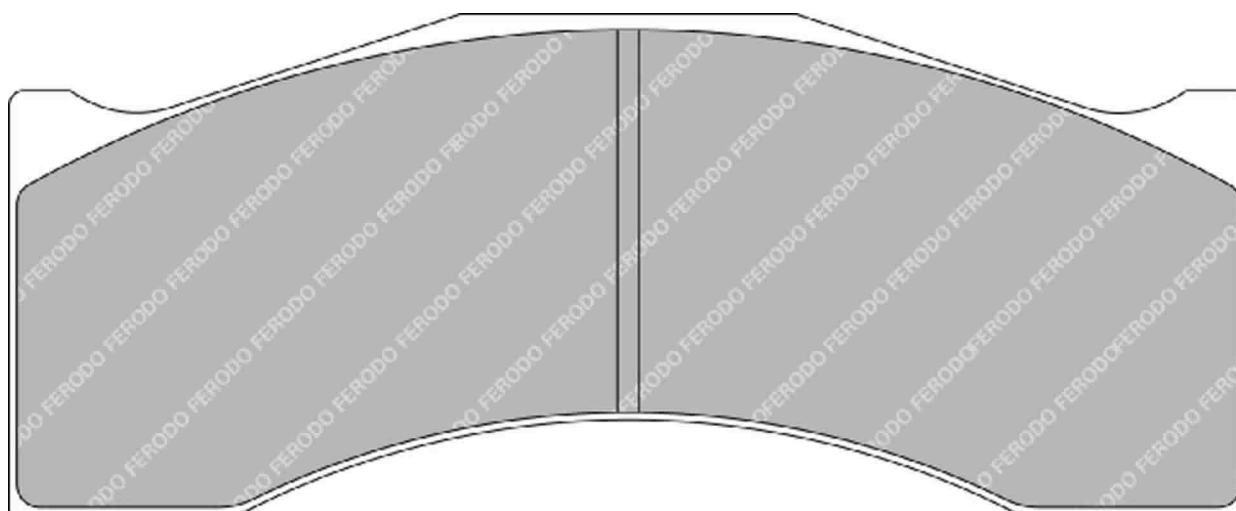

MATERIAL AVAILABILITY						
H	C	R	W	WB	Z	ZB

- Available
- Exhausting
- Out of Range
- Make to order
- In Introduction

FRP3081

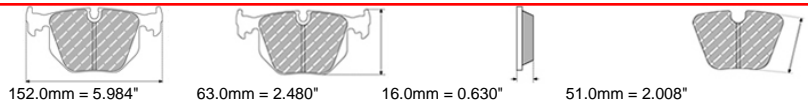

MITSUBISHI Front

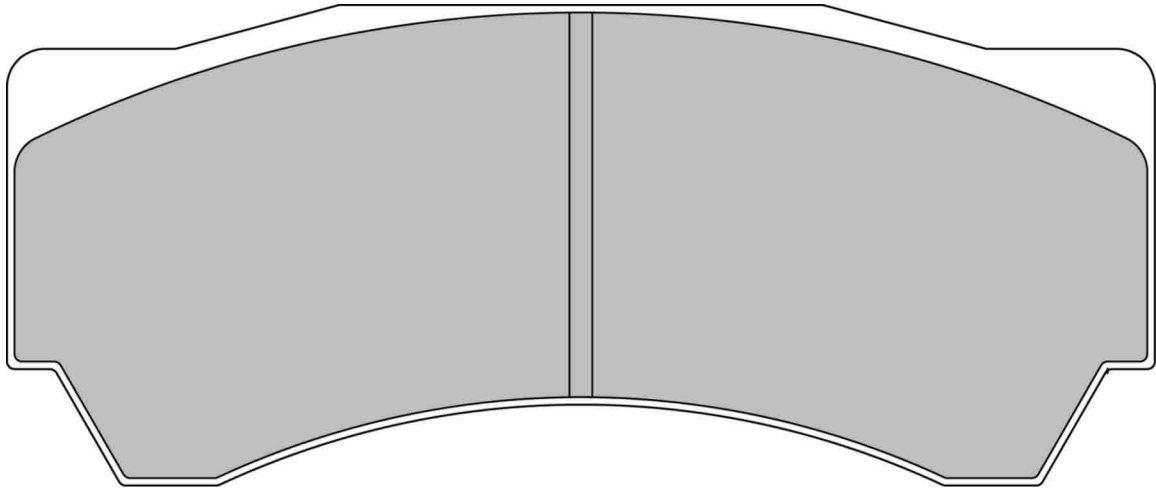

ALSO AVAILABLE		
SHAPE	TH. MM	NOTES
FRP3142		For Alcon Kits with caliper pin guides

CROSS REFERENCE	
ALCON	PNF4497X607.4
ALCON	PNF4497X617.4

MATERIAL AVAILABILITY						
H	C	R	W	WB	Z	ZB
✓		✓	✉		✉	

FRP3082

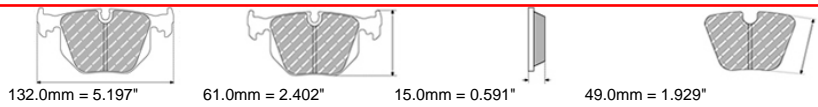

MITSUBISHI Rear

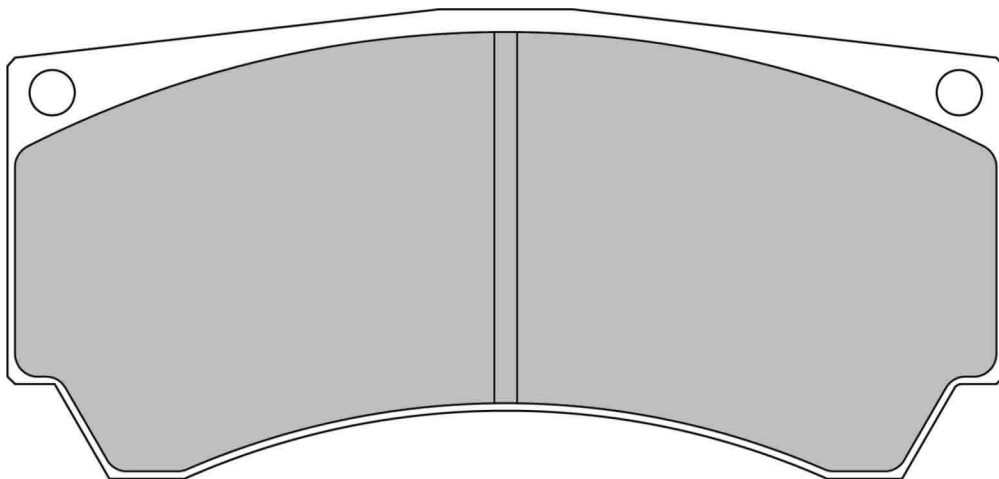

MATERIAL AVAILABILITY						
H	C	R	W	WB	Z	ZB
✓		✓	✉		✉	

CROSS REFERENCE	
ALCON	PNF4498X703.4
ALCON	PNF4498X705.4
PAGID	8050

FRP3083

WVA No: 24974 16,70 - 20345 16,90

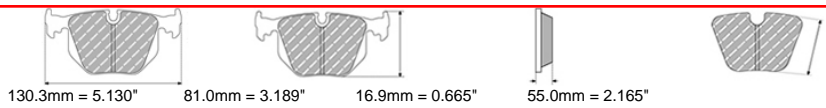

LOTUS Front, MCLAREN Rear, RENAULT Front, SEAT Front

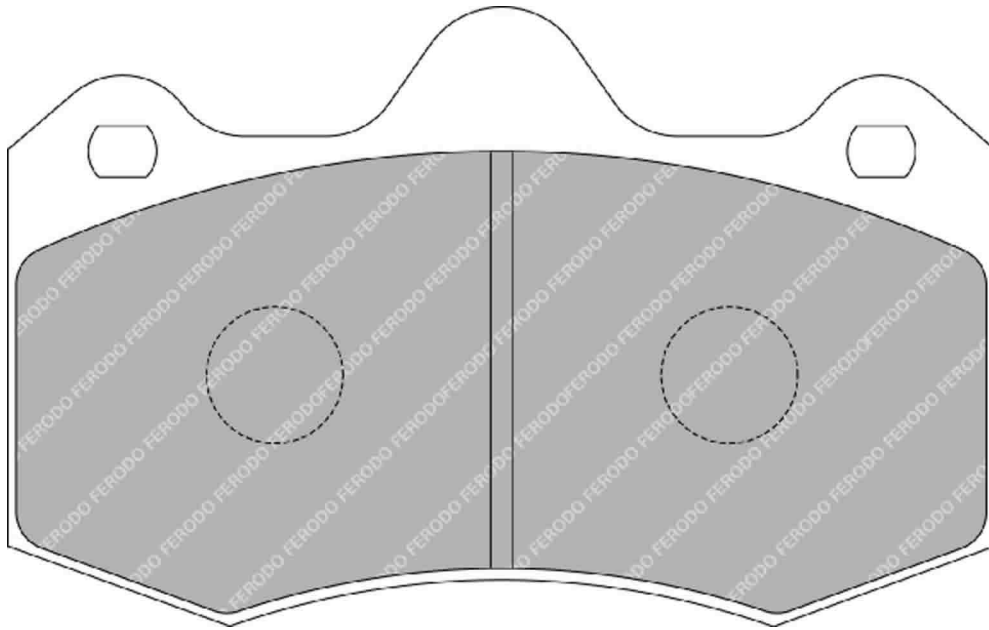

ALSO AVAILABLE		
SHAPE	TH. MM	NOTES
FRP3107	no	D50

MATERIAL AVAILABILITY						
H	C	R	W	WB	Z	ZB
✓		✓	✓		✓	

CROSS REFERENCE	
AP RACING	CP6600D55
ENDLESS	RCP100
PAGID	20345
PAGID	4345
WVA	24974 16,70 - 20345 16,90

✓ Available ⚠ Exhausting
 ✗ Out of Range 📦 Make to order
 📌 In Introduction

FRP3084



149.3mm = 5.878"



86.0mm = 3.386"



16.9mm = 0.665"



57.5mm = 2.264"

ASTON MARTIN Front, KIA Front, MCLAREN Front, SEAT Front

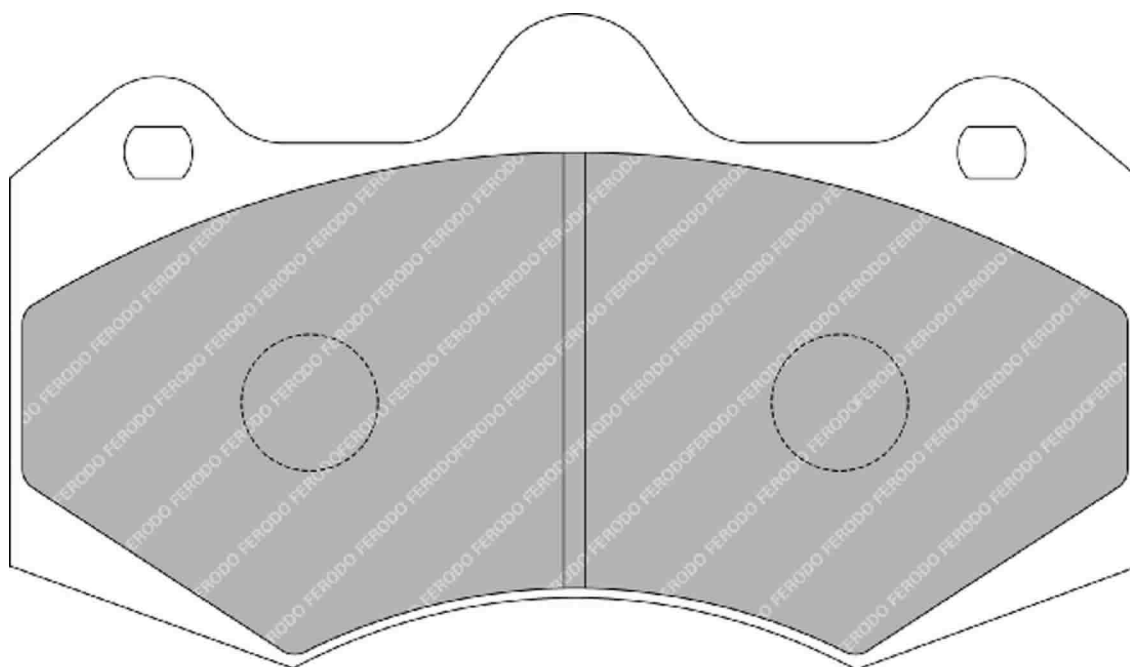

MATERIAL AVAILABILITY						
H	C	R	W	WB	Z	ZB
✓		✓	✓		✓	✉

CROSS REFERENCE	
AP RACING	CP7040D61
PAGID	20346
PAGID	4346
PAGID	4346

FRP3085

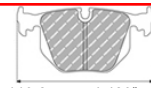

113.8mm = 4.480"



59.0mm = 2.323"



16.2mm = 0.638"

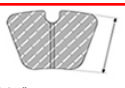

46.1mm = 1.815"

LOTUS Front, MG Front

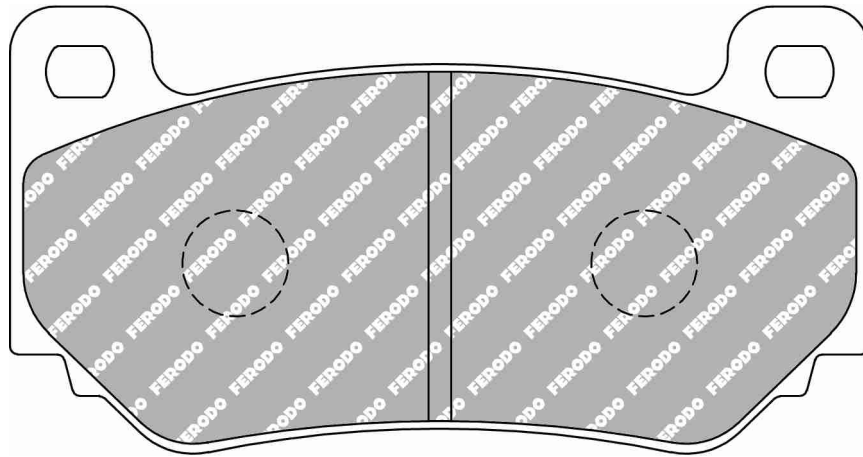

ALSO AVAILABLE

SHAPE	TH. MM	NOTES
FCP4972	14.5	

MATERIAL AVAILABILITY

H	C	R	W	WB	Z	ZB
✓		✓	✓		✓	

CROSS REFERENCE

AP RACING	CP7600D46
PAGID	20349
PAGID	4349

FRP3086



86.2mm = 3.394"



63.0mm = 2.480"



18.0mm = 0.709"



46.0mm = 1.811"

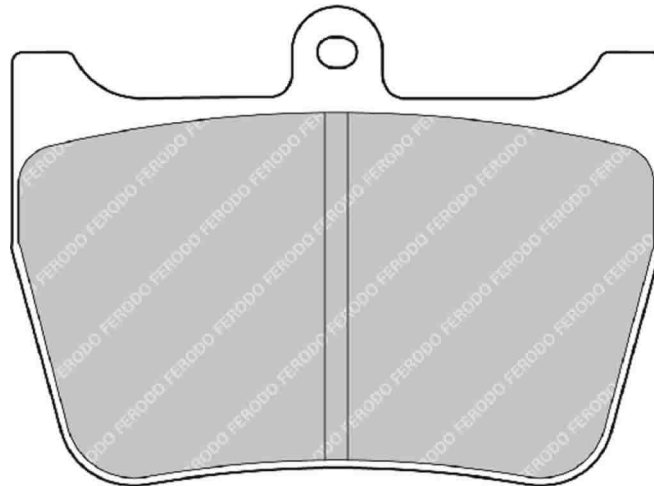

4 Pistons caliper (1 set = 4 pads) - 2 sets per axle for the recommended applications

ALSO AVAILABLE

SHAPE	TH. MM	NOTES
FRP3020	15	

MATERIAL AVAILABILITY

H	C	R	W	WB	Z	ZB
		✓				

CROSS REFERENCE

AP RACING	CP4848D46 (18 mm)
AP RACING	CP5148DXX
PFC	7804.XX.18

✓ Available
 ✗ Out of Range
 ⓘ In Introduction
 ⚠ Exhausting
 📦 Make to order

FERODO
RACING
 Updated on 17th Aug 2018

3305

FRP3087



139.8mm = 5.504"



61.4mm = 2.417"



17.5mm = 0.689"

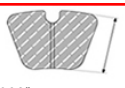

48.4mm = 1.906"

FORD Front / Rear, MITSUBISHI Front

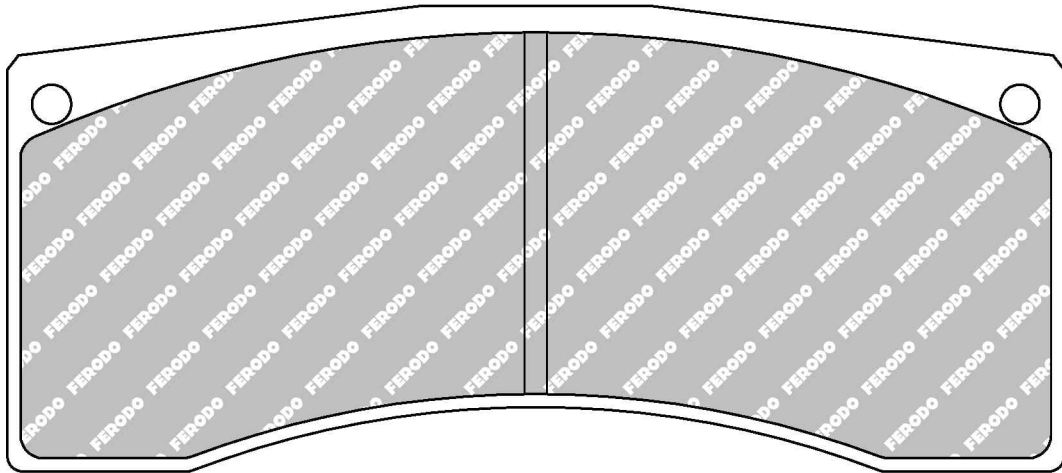

ALSO AVAILABLE

SHAPE	TH. MM	NOTES
FRP3024	20	
FRP3029	26	
FRP3030	28	
FRP3140	16	

CROSS REFERENCE

BREMBO	07.7859.60
BREMBO	07.7859.70
PAGID	8030
PFC	7770.XX.17

MATERIAL AVAILABILITY

H	C	R	W	WB	Z	ZB
		✓	✓		✓	

FRP3088

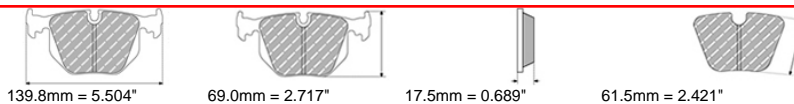

MITSUBISHI Front, PEUGEOT Front

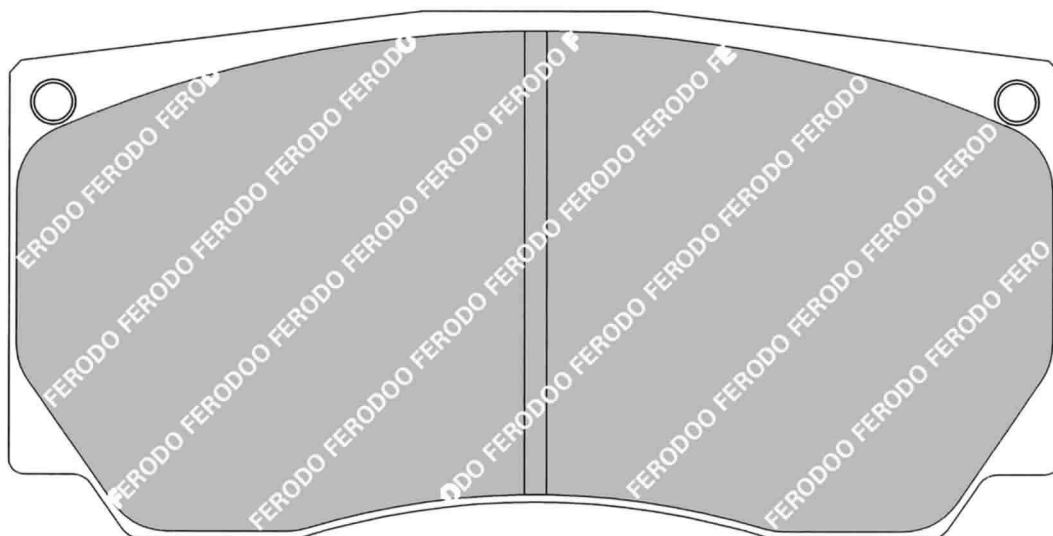

MATERIAL AVAILABILITY						
H	C	R	W	WB	Z	ZB
		✓	✗		✓	

CROSS REFERENCE	
BREMBO	07.6955.50
PAGID	8033
PFC	7772.XX.18

FRP3091

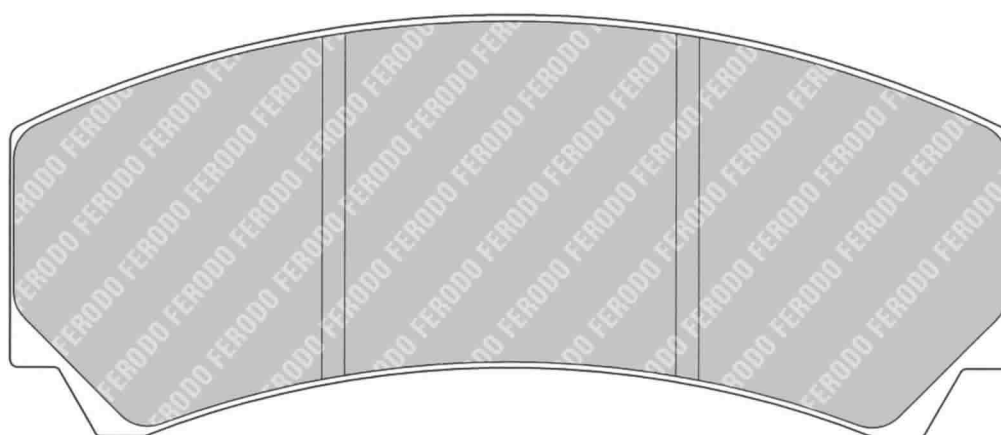
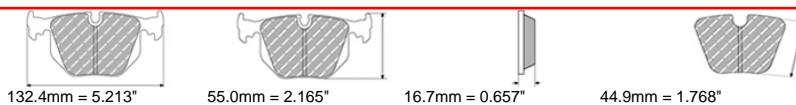

MATERIAL AVAILABILITY						
H	C	R	W	WB	Z	ZB
		✉				

CROSS REFERENCE	
AP RACING	CP3215D46

- ✓ Available
- ✗ Out of Range
- ✉ In Introduction
- ⚠ Exhausting
- 📄 Make to order

FRP3092

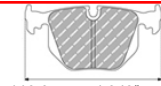

110.3mm = 4.343"



39.0mm = 1.535"



18.0mm = 0.709"

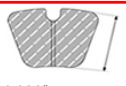

34.0mm = 1.339"

Formula Renault Front / Rear

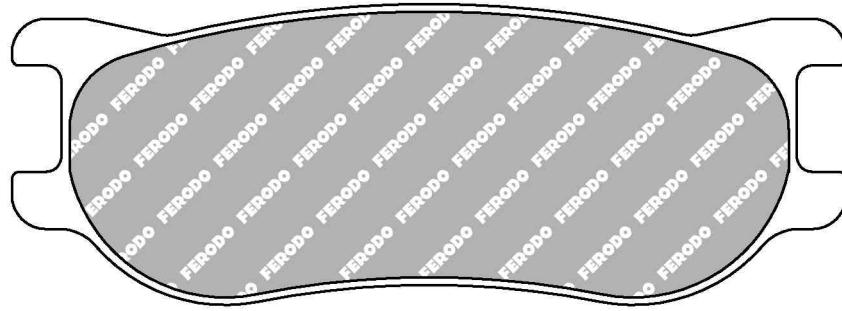

MATERIAL AVAILABILITY						
H	C	R	W	WB	Z	ZB

CROSS REFERENCE	
PAGID	8034

FRP3094



59.0mm = 2.323"



54.0mm = 2.126"



15.5mm = 0.610"



47.5mm = 1.870"

CHEVROLET Front / Rear

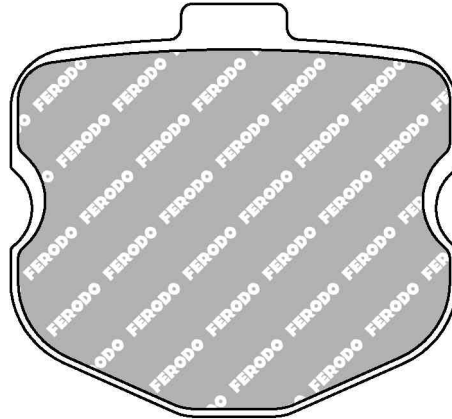

MATERIAL AVAILABILITY						
H	C	R	W	WB	Z	ZB

CROSS REFERENCE	
PAGID	8240
PAGID	8240front
PAGID	8240rear

FRP3095

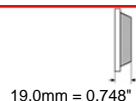

PORSCHE Rear

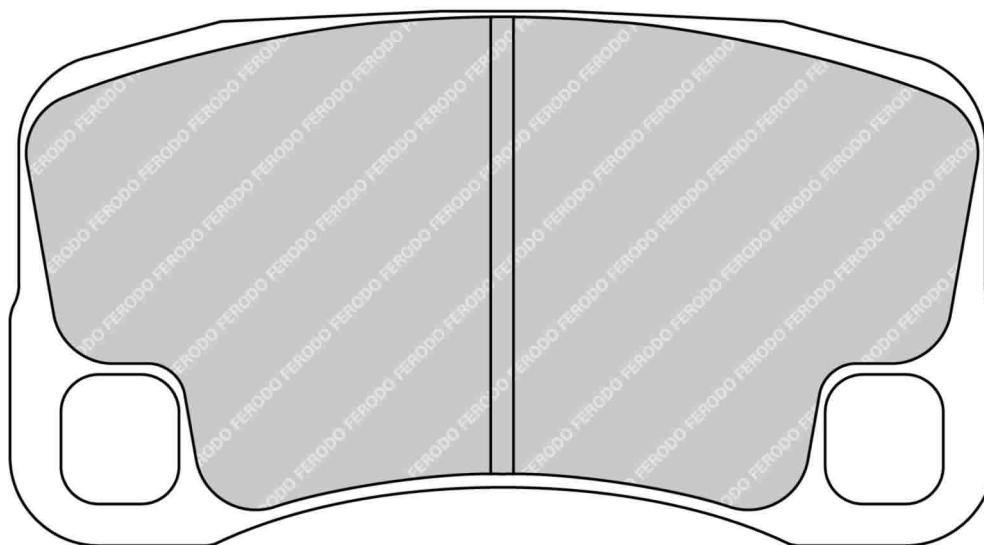

ALSO AVAILABLE		
SHAPE	TH. MM	NOTES
FRP3143	17.0	

CROSS REFERENCE	
PAGID	8006

MATERIAL AVAILABILITY						
H	C	R	W	WB	Z	ZB
✓			✓		✗	✉

✓ Available ⚠ Exhausting
 ✗ Out of Range ✉ Make to order
 📄 In Introduction

FRP3096

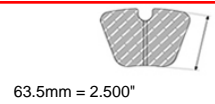
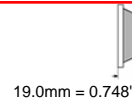
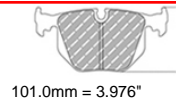
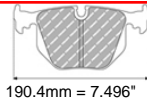

PORSCHE Front

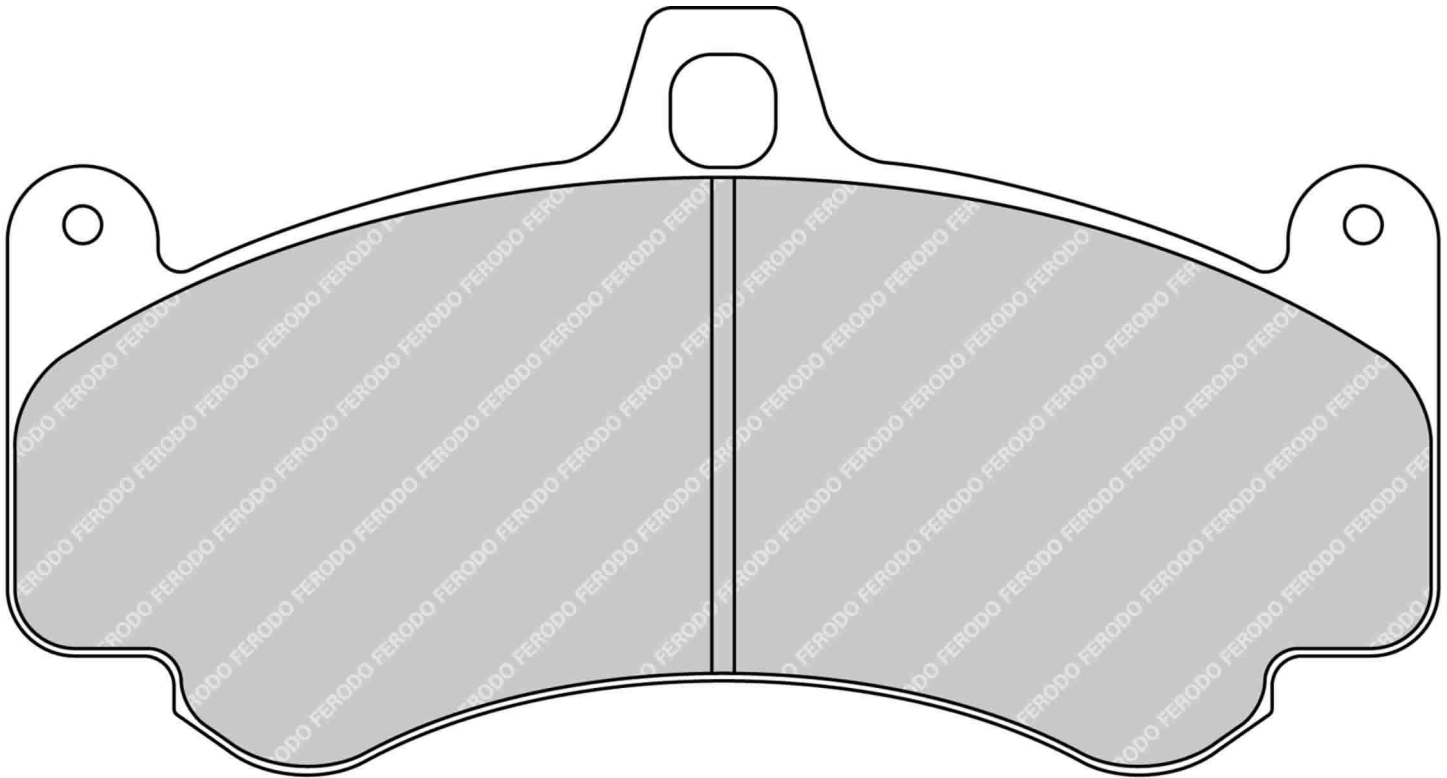

ALSO AVAILABLE		
SHAPE	TH. MM	NOTES
FRP3075	17.5	

CROSS REFERENCE	
CL BRAKES	4126
PAGID	8004

MATERIAL AVAILABILITY						
H	C	R	W	WB	Z	ZB
✓			✓		✗	✉

FRP3097

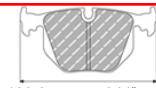

133.2mm = 5.244"



61.0mm = 2.402"



20.4mm = 0.803"

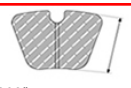

43.0mm = 1.693"

FORD Front

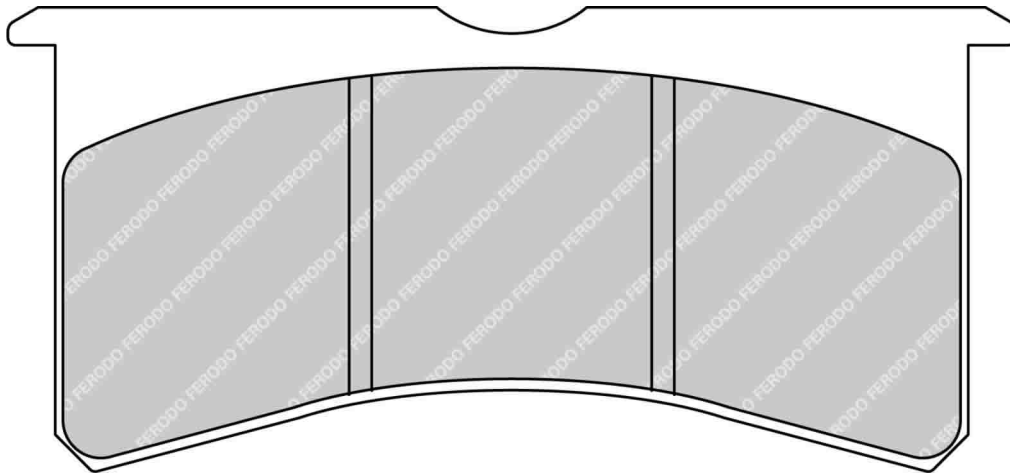

Same as FRP501 but fixed bridge caliper

ALSO AVAILABLE

SHAPE	TH. MM	NOTES
FRP501	none	Non-Fixed Bridge caliper

MATERIAL AVAILABILITY

H	C	R	W	WB	Z	ZB
✓		✓	✓		✓	

CROSS REFERENCE

AP RACING	CP8250-D41
PAGID	2205
Wilwood	7420

FRP3098

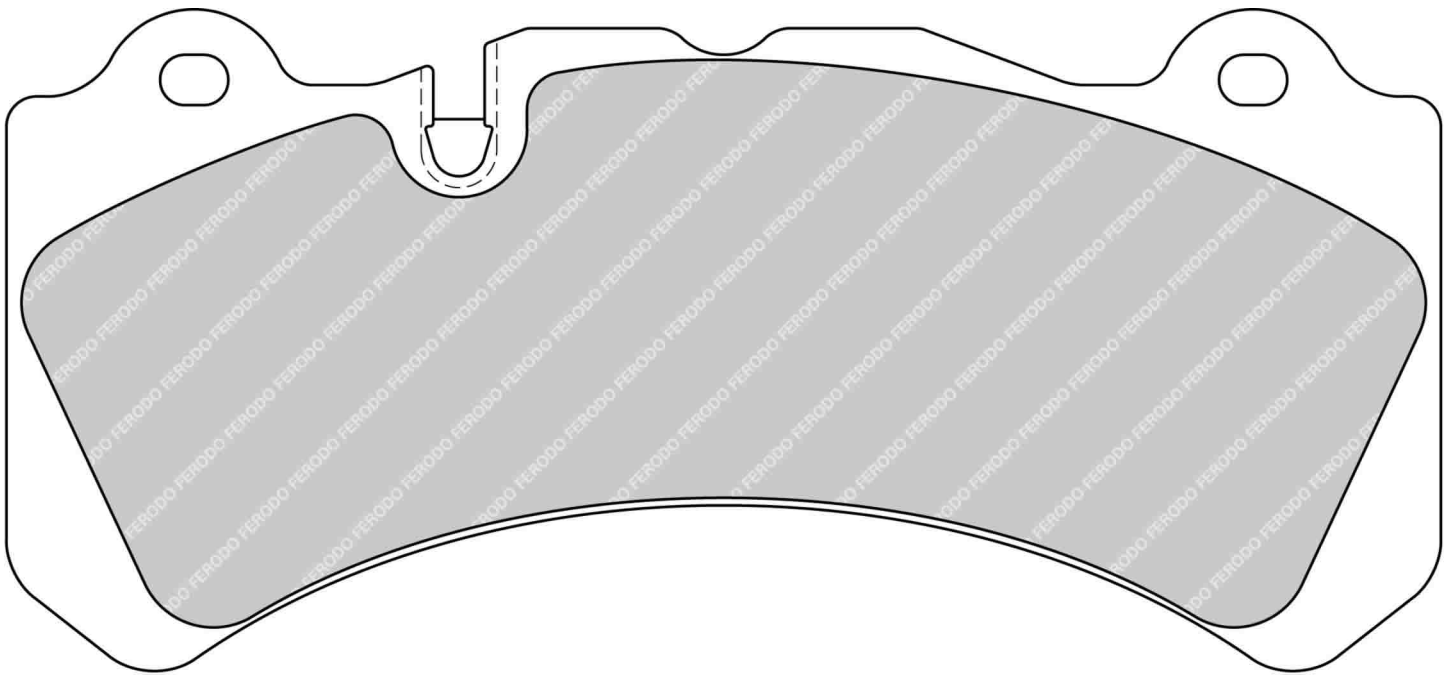
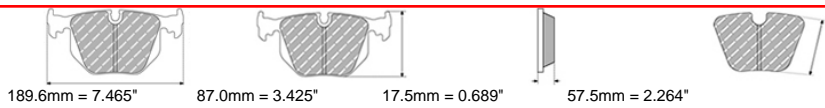

MATERIAL AVAILABILITY						
H	C	R	W	WB	Z	ZB
✓		✓	✓		✓	

CROSS REFERENCE	
BREMBO	07.9551.13
BREMBO	07.B314.59 (Th 16.8)
PAGID	8062

FRP3099



189.8mm = 7.472"

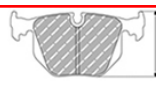

73.0mm = 2.874"



17.5mm = 0.689"

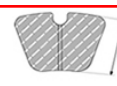

48.0mm = 1.890"

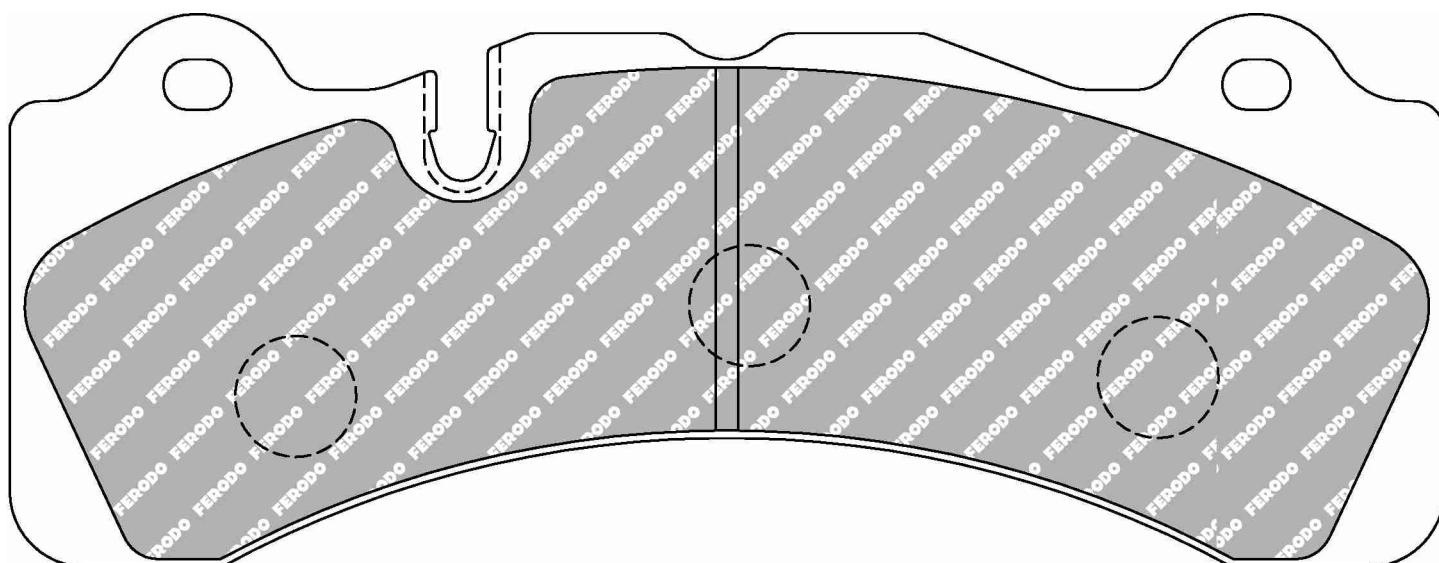

MATERIAL AVAILABILITY						
H	C	R	W	WB	Z	ZB
✓		✓	✓		✉	

CROSS REFERENCE	
BREMBO	07.B314.58
BREMBO	XA5.71.M2
PAGID	8061

- ✓ Available
- ✗ Out of Range
- ⓘ In Introduction
- ⚠ Exhausting
- ✉ Make to order

FRP3100

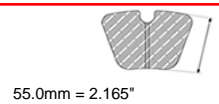
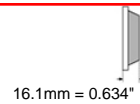
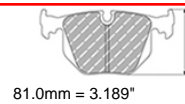
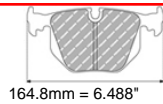

FMSI No: D1116

ALFA ROMEO Front, LEXUS Front, MASERATI Front, MERCEDES Front, SUBARU Front

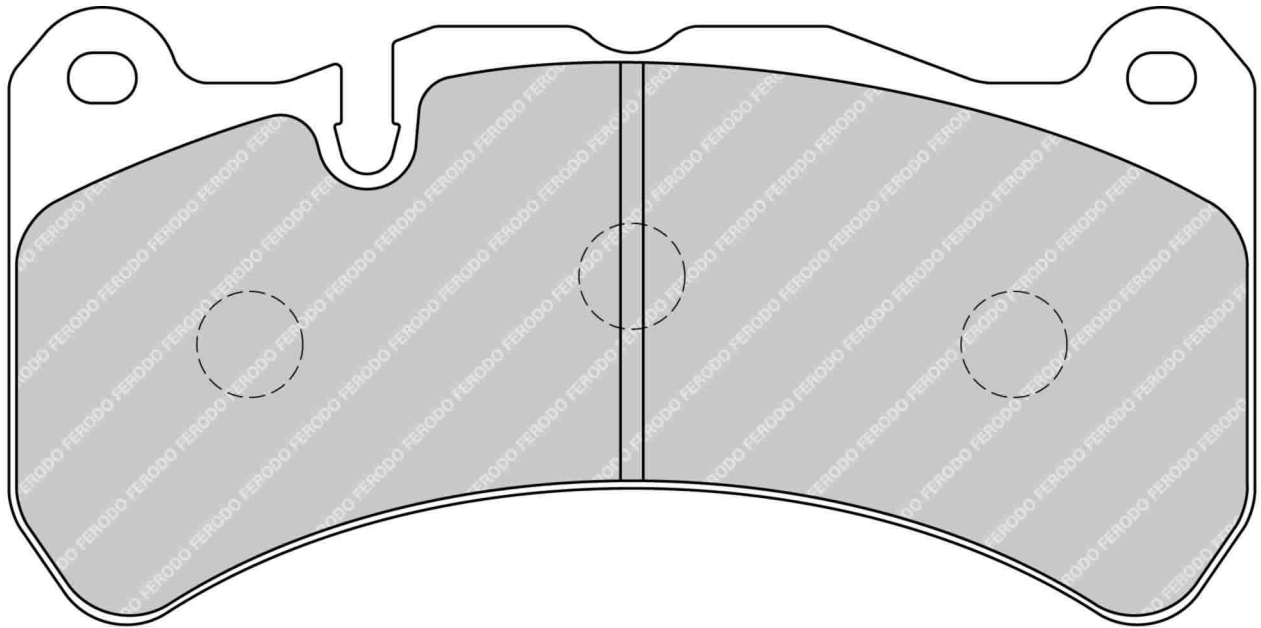

MATERIAL AVAILABILITY						
H	C	R	W	WB	Z	ZB
✓		📦				

CROSS REFERENCE	
BREMBO	07.8365.33
BREMBO	07.9209.xx
FMSI	D1116
PAGID	8005

FRP3101

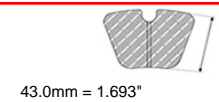
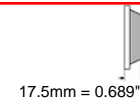
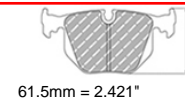
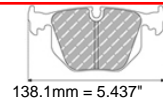

PEUGEOT Front / Rear

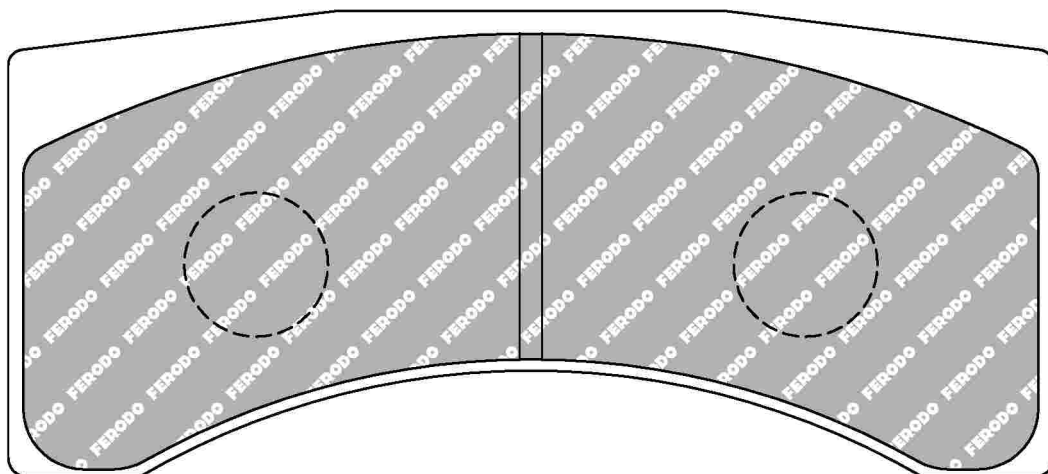

MATERIAL AVAILABILITY						
H	C	R	W	WB	Z	ZB
					✓	

3314

FERODO
RACING
Updated on 17th Aug 2018

✓ Available ⚠ Exhausting
 ✗ Out of Range 📦 Make to order
 🔄 In Introduction

FRP3102



99.8mm = 3.929"



39.0mm = 1.535"



16.0mm = 0.630"

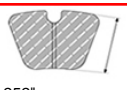

31.8mm = 1.252"

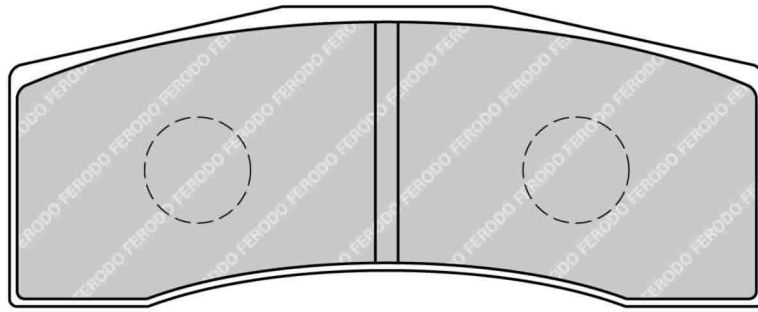

MATERIAL AVAILABILITY						
H	C	R	W	WB	Z	ZB
			✓		✓	

CROSS REFERENCE	
AP RACING	CP7031D32
PAGID	8060

FRP3103



103.8mm = 4.087"



45.0mm = 1.772"



16.0mm = 0.630"



37.5mm = 1.476"

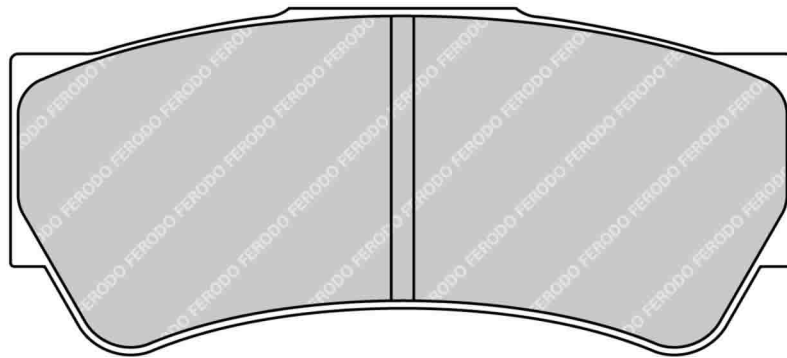

MATERIAL AVAILABILITY						
H	C	R	W	WB	Z	ZB
		✉	✉		✓	✉

CROSS REFERENCE	
BREMBO	07.A262.20
PAGID	8049

FRP3104

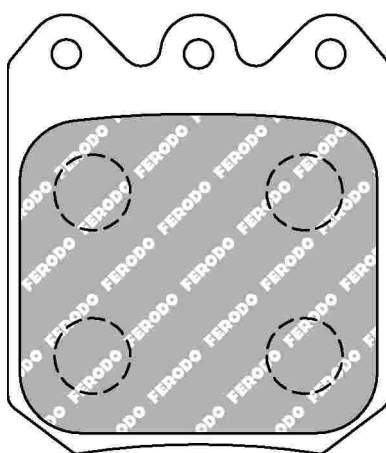
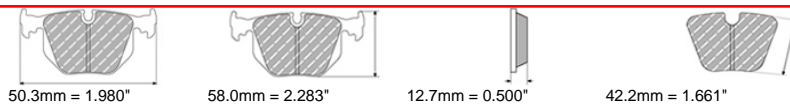

MATERIAL AVAILABILITY						
H	C	R	W	WB	Z	ZB

CROSS REFERENCE	
Wilwood	6812

FRP3105

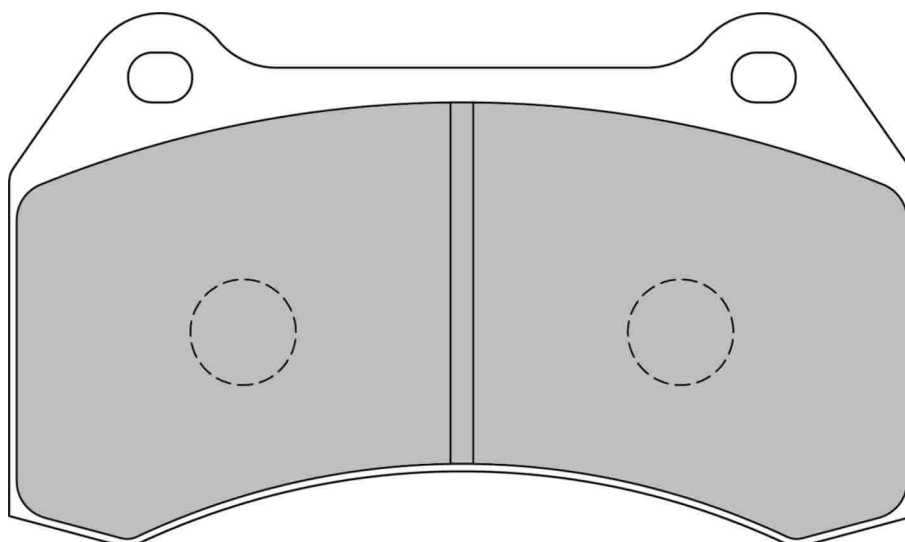

MATERIAL AVAILABILITY						
H	C	R	W	WB	Z	ZB

FRP3106

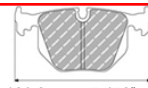

189.8mm = 7.472"



92.9mm = 3.657"



18.8mm = 0.740"

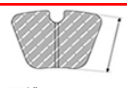

65.0mm = 2.559"

FMSI No: D1382

NISSAN Front

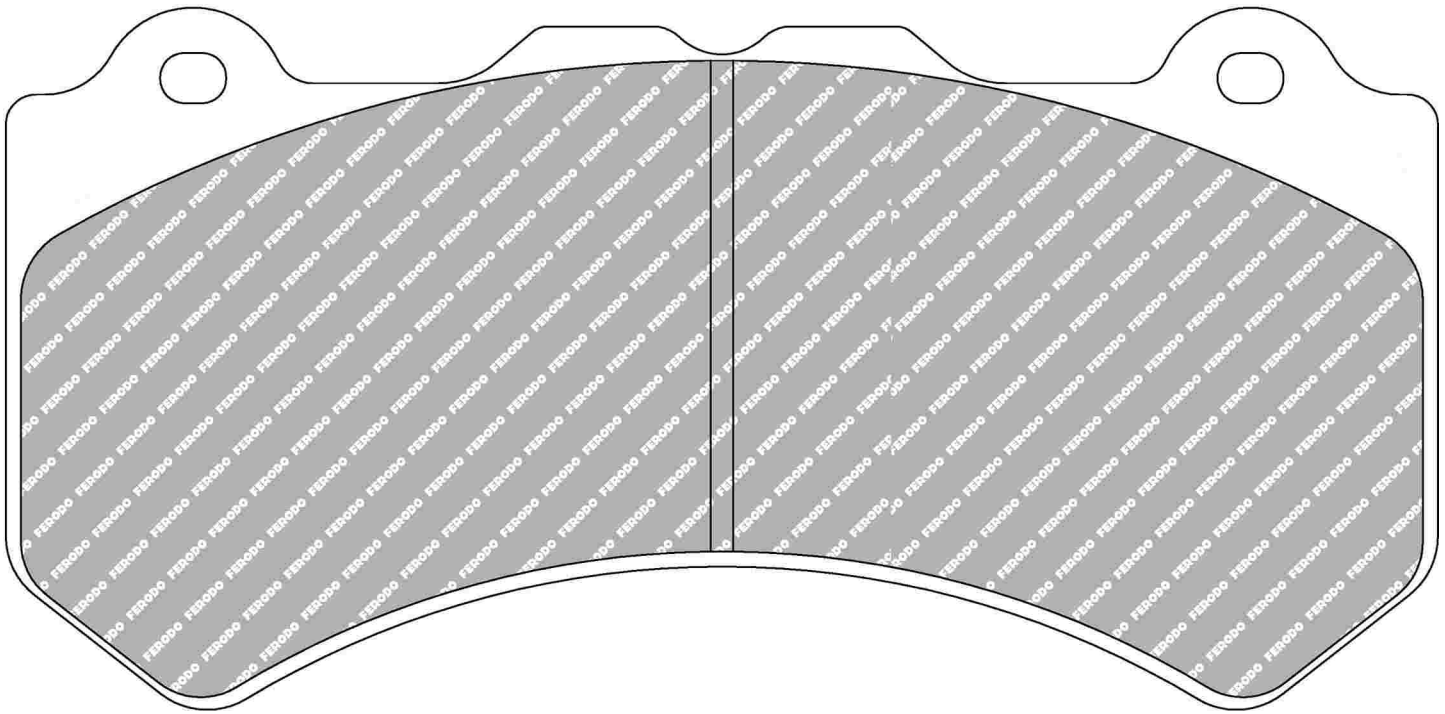

ALSO AVAILABLE

SHAPE	TH. MM	NOTES
FRP3133	16.5	

MATERIAL AVAILABILITY

H	C	R	W	WB	Z	ZB
✓		✓	✗	✓	✓	

CROSS REFERENCE

BREMBO	07.8590.15
FMSI	D1382
PAGID	8081

✓ Available ⚠ Exhausting
 ✗ Out of Range 📦 Make to order
 📅 In Introduction

FRP3107

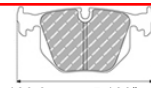

130.3mm = 5.130"



78.0mm = 3.071"



16.9mm = 0.665"

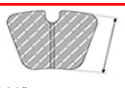

50.0mm = 1.969"

PEUGEOT Front

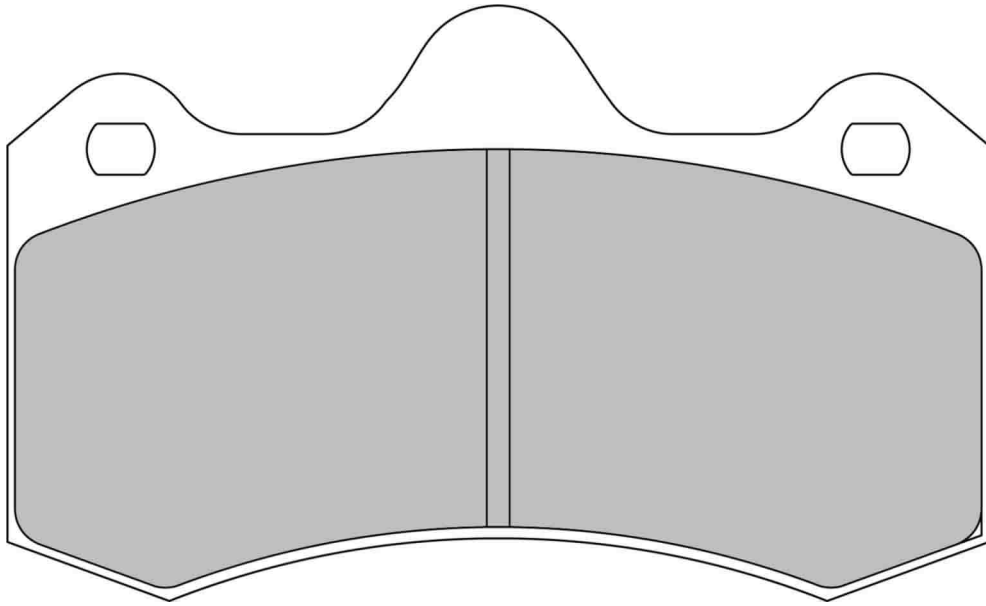

ALSO AVAILABLE

SHAPE	TH. MM	NOTES
FRP3083		D55

CROSS REFERENCE

AP RACING	CP6600D50
-----------	-----------

MATERIAL AVAILABILITY

H	C	R	W	WB	Z	ZB
✓		✓				

FRP3108



79.4mm = 3.126"



58.0mm = 2.283"



12.5mm = 0.492"



44.3mm = 1.744"

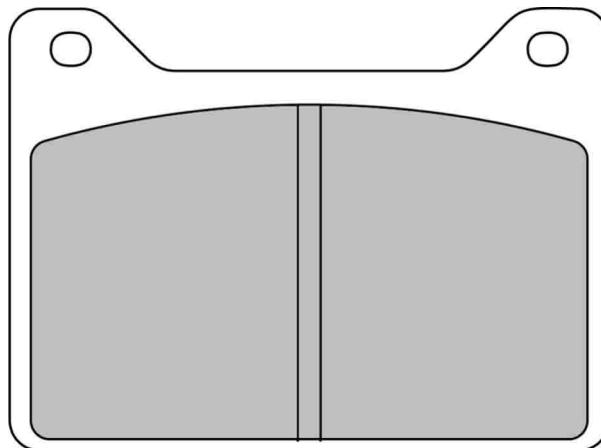

MATERIAL AVAILABILITY

H	C	R	W	WB	Z	ZB
✓					✓	

CROSS REFERENCE

EBC	DP4057
Wilwood	7912

3318

FERODO

RACING
Updated on 17th Aug 2018

✓ Available ⚠ Exhausting
 ✗ Out of Range 📦 Make to order
 🔄 In Introduction

FRP3109



109.8mm = 4.323"



69.0mm = 2.717"



12.5mm = 0.492"

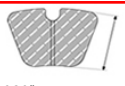

51.3mm = 2.020"

ASTON MARTIN Rear

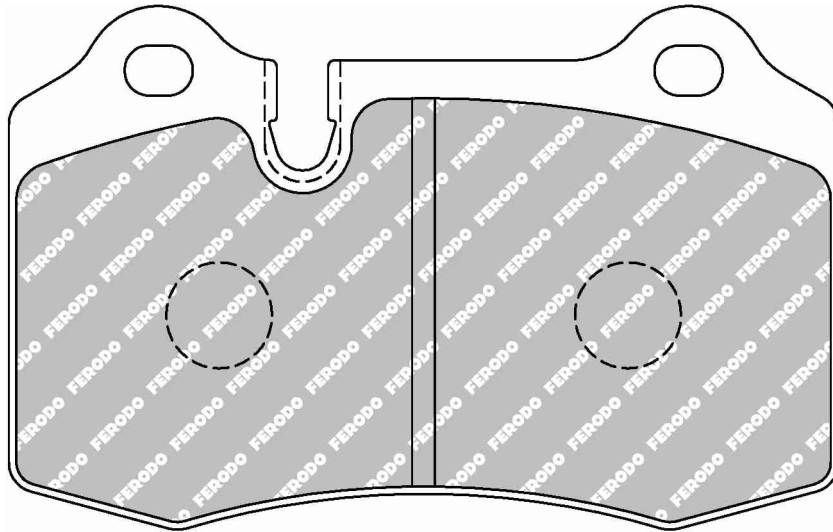

ALSO AVAILABLE		
SHAPE	TH. MM	NOTES
FCP721	17.3	
FCP1348	15	

CROSS REFERENCE	
BREMBO	XA4.17.M4

MATERIAL AVAILABILITY						
H	C	R	W	WB	Z	ZB

- Available
- Out of Range
- In Introduction
- Exhausting
- Make to order

FRP3110

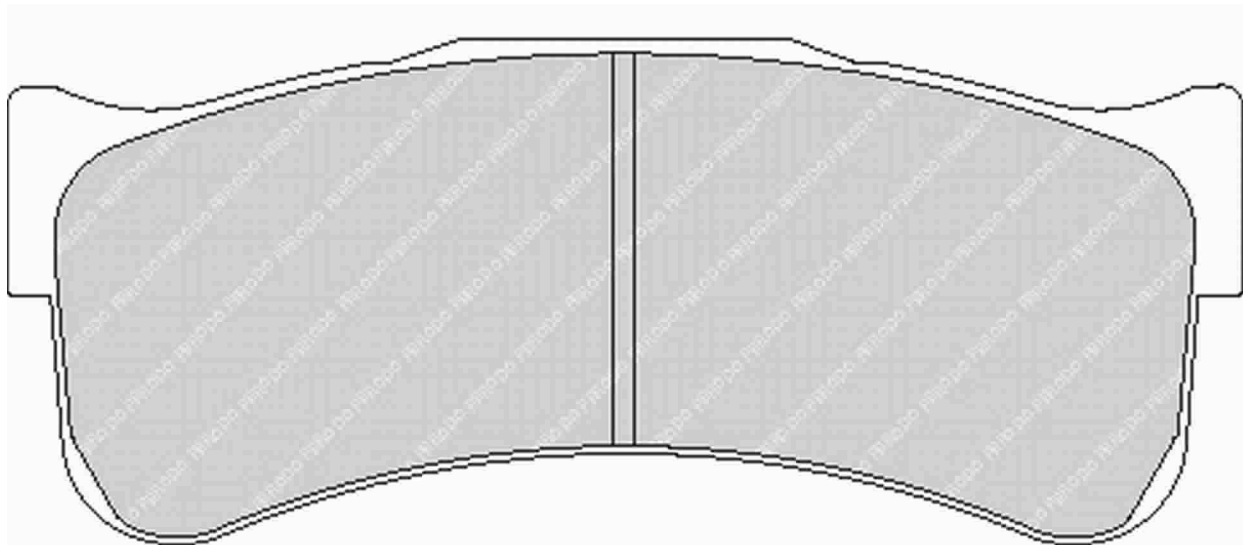
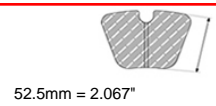
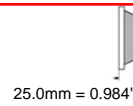
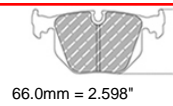

ALSO AVAILABLE		
SHAPE	TH. MM	NOTES
FRP3031	29	
FRP3123	21.5	

CROSS REFERENCE	
BREMBO	07.7293.7
PAGID	8087

MATERIAL AVAILABILITY						
H	C	R	W	WB	Z	ZB

FRP3112

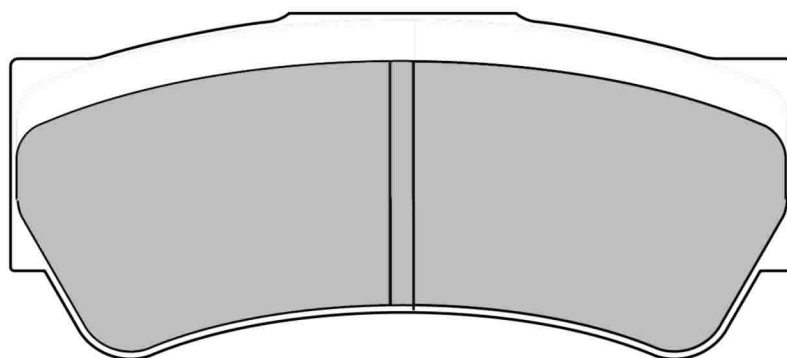
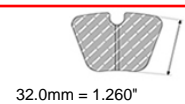
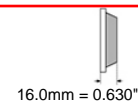
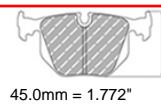
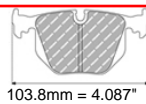

BREMBO 2009 F3 System - for reduced diameter rear disc - Material availability on request

MATERIAL AVAILABILITY						
H	C	R	W	WB	Z	ZB

FRP3113

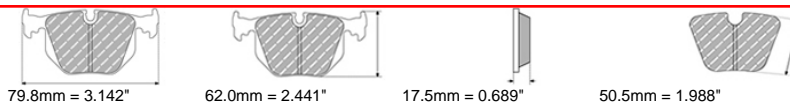

FORD Front

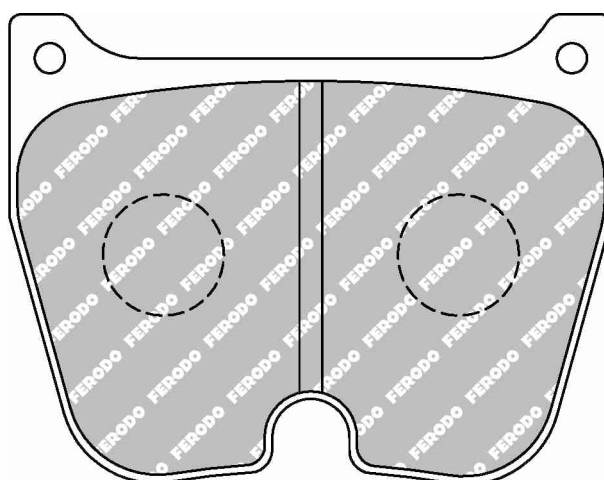

MATERIAL AVAILABILITY						
H	C	R	W	WB	Z	ZB

CROSS REFERENCE	
BREMBO	07.A010.10

FRP3114

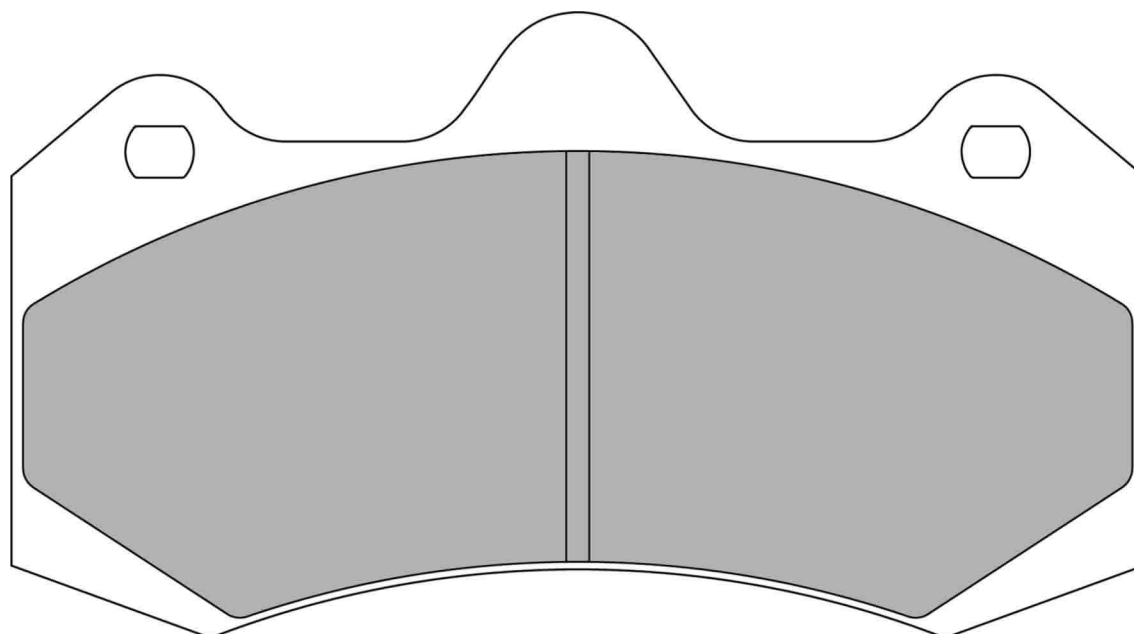
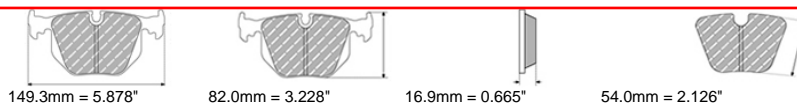

MATERIAL AVAILABILITY						
H	C	R	W	WB	Z	ZB

CROSS REFERENCE	
AP RACING	CP7040D54

- Available
- Exhausting
- Out of Range
- Make to order
- In Introduction

FRP3115

WVA No: 25594 15,9



130.0mm = 5.118"



73.0mm = 2.874"



14.8mm = 0.583"

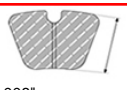

51.0mm = 2.008"

LOTUS Rear

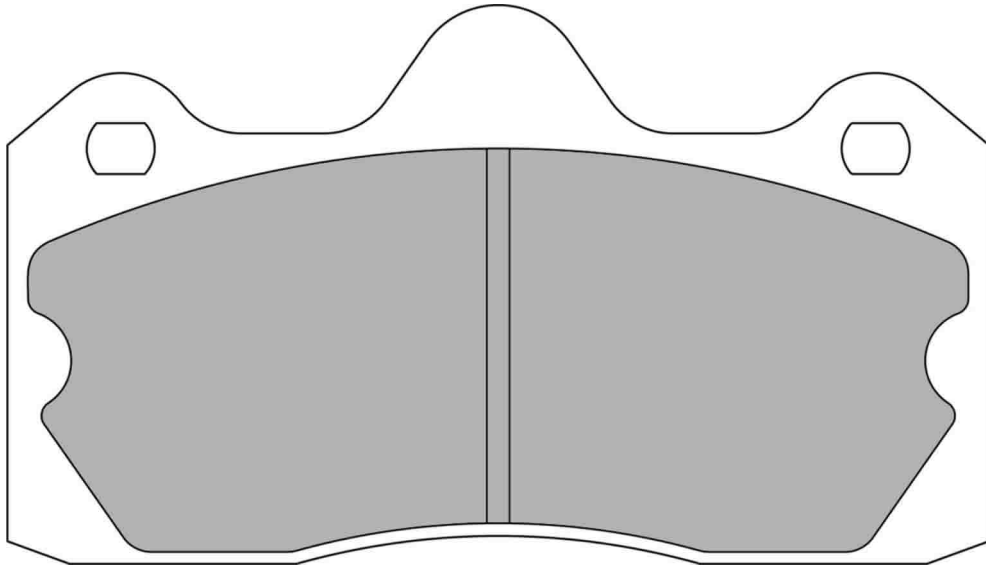

MATERIAL AVAILABILITY

H	C	R	W	WB	Z	ZB
✓		✉	✓			

CROSS REFERENCE

AP RACING	CP6627D51
PAGID	8214
WVA	25594 15,9

FRP3116



133.2mm = 5.244"



66.0mm = 2.598"



20.4mm = 0.803"



50.0mm = 1.969"

FORD Front

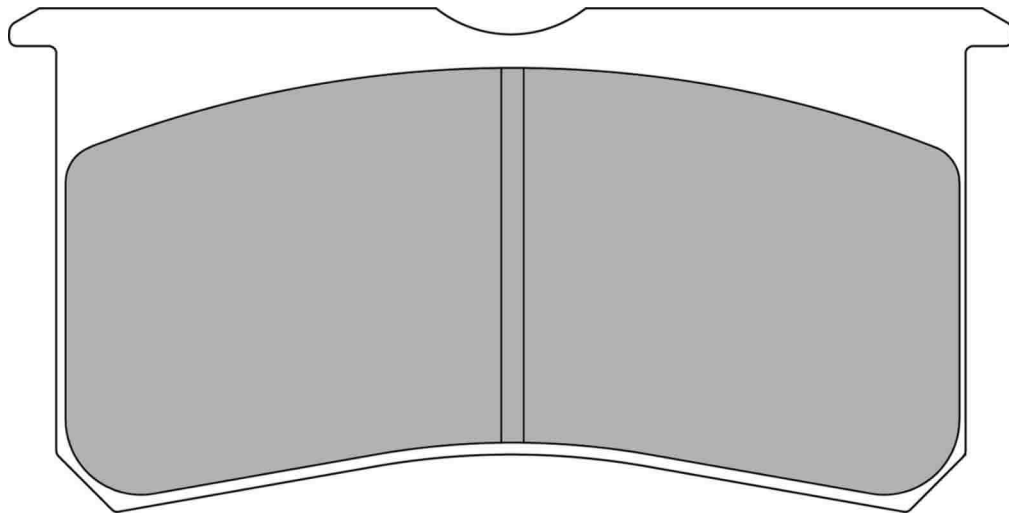

MATERIAL AVAILABILITY

H	C	R	W	WB	Z	ZB
✓		✓	✓		✓	

CROSS REFERENCE

AP RACING	CP8250D50
-----------	-----------

3322

FERODO
RACING
Updated on 17th Aug 2018

✓ Available ⚠ Exhausting
 ✗ Out of Range ✉ Make to order
 🔄 In Introduction

FRP3117

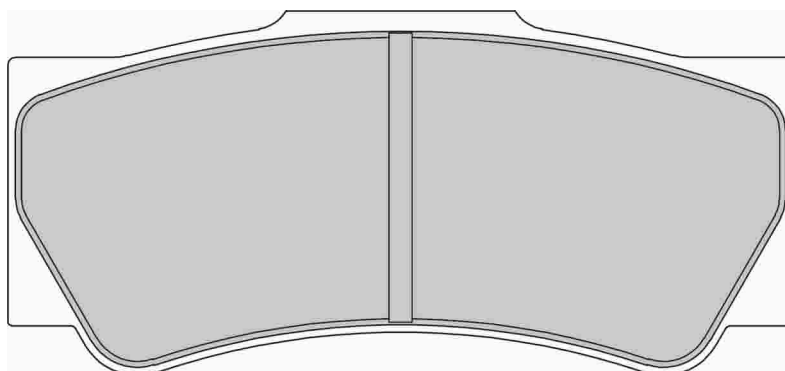
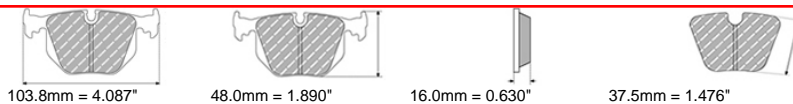

MATERIAL AVAILABILITY						
H	C	R	W	WB	Z	ZB
		✓				

CROSS REFERENCE	
PAGID	8078

FRP3118

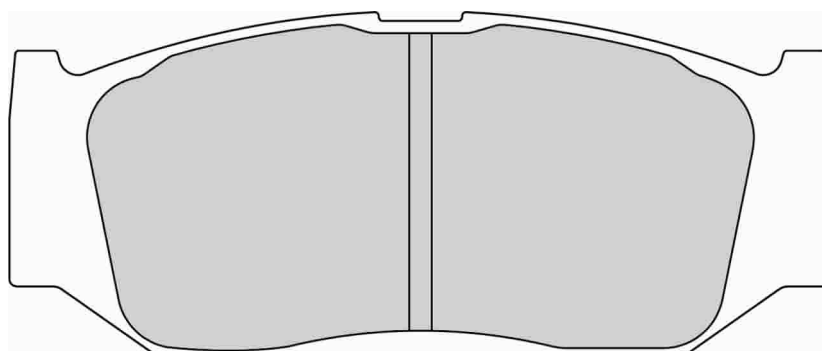
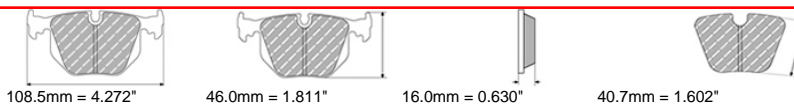

SUZUKI Front

MATERIAL AVAILABILITY						
H	C	R	W	WB	Z	ZB
			✓			

CROSS REFERENCE	
Oe Suzuki	5581057K01

FRP3119



156.4mm = 6.157"



55.0mm = 2.165"



17.9mm = 0.705"



48.1mm = 1.894"

RENAULT Front

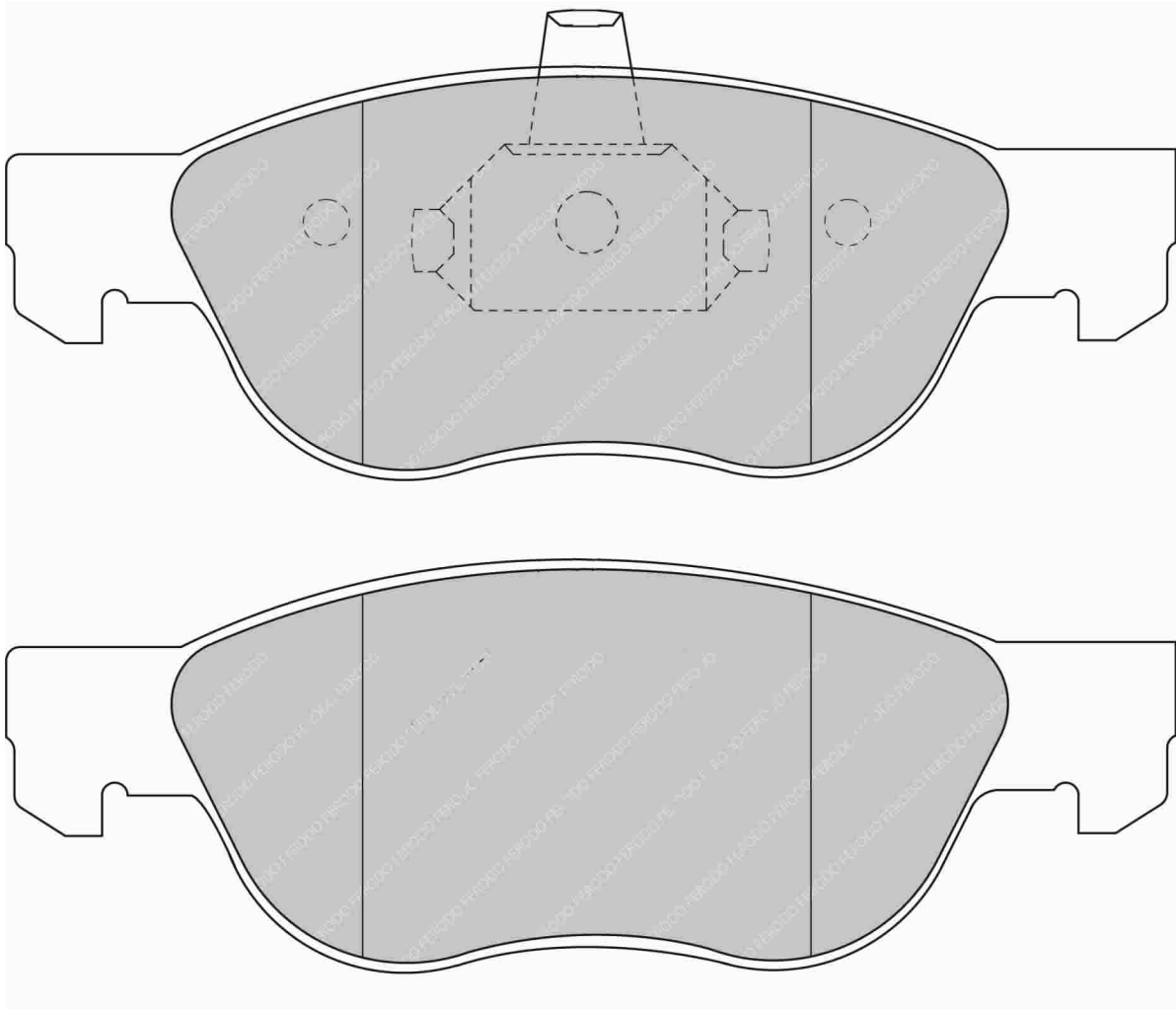

MATERIAL AVAILABILITY

H	C	R	W	WB	Z	ZB
					✓	

3324

FERODO

RACING

Updated on 17th Aug 2018

✓ Available ⚠ Exhausting
 ✗ Out of Range 📦 Make to order
 🔄 In Introduction

FRP3120

WVA No: 23855 16,00

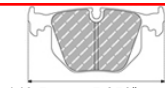

143.5mm = 5.650"



59.0mm = 2.323"



16.5mm = 0.650"



49.0mm = 1.929"

TOYOTA Front

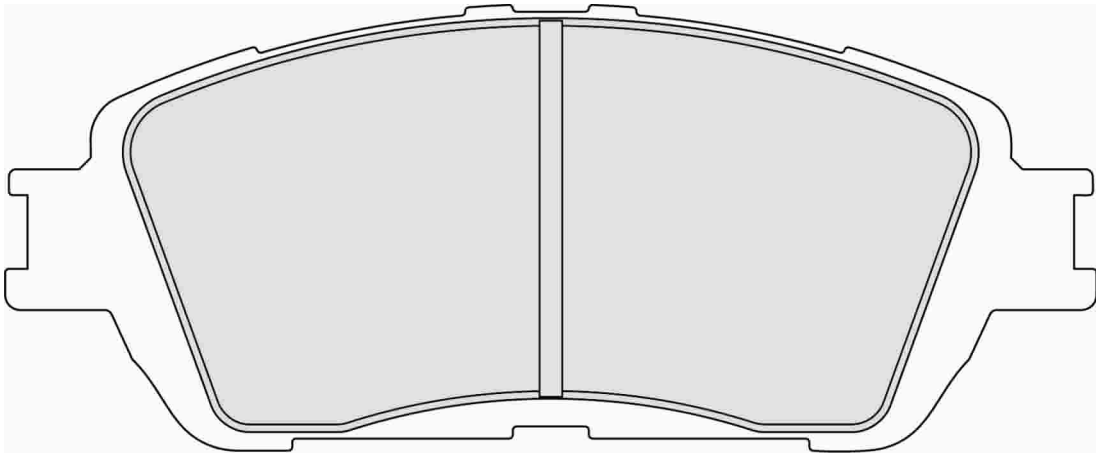

MATERIAL AVAILABILITY						
H	C	R	W	WB	Z	ZB
✓						

CROSS REFERENCE	
WVA	23855 16,00

FRP3121



147.6mm = 5.811"



60.0mm = 2.362"



17.5mm = 0.689"

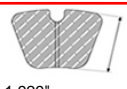

49.0mm = 1.929"

TOYOTA Front

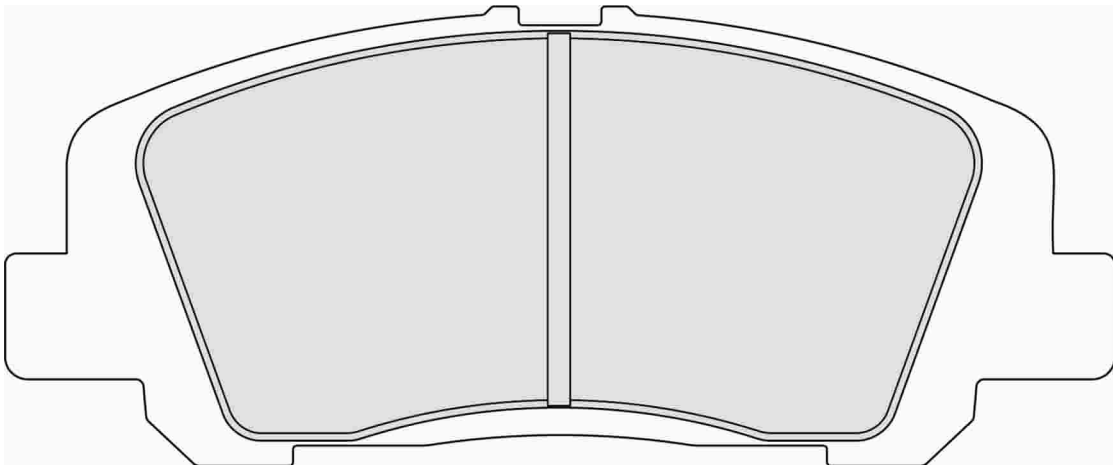

MATERIAL AVAILABILITY						
H	C	R	W	WB	Z	ZB
✓					✉	

- ✓ Available
- ✗ Out of Range
- ✉ In Introduction
- ⚠ Exhausting
- ✉ Make to order

FRP3122

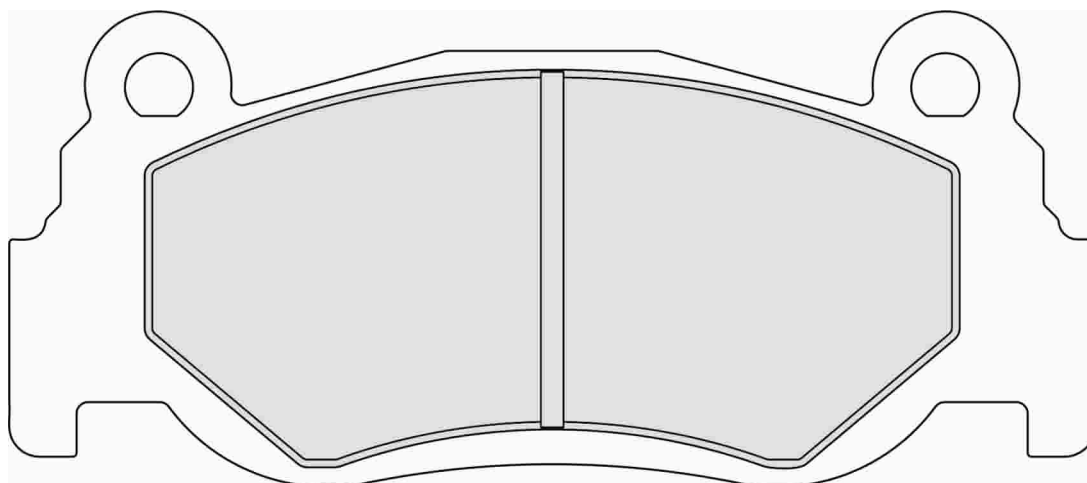
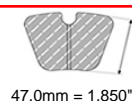
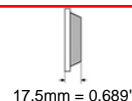

ATE Kit

MATERIAL AVAILABILITY						
H	C	R	W	WB	Z	ZB

FRP3123

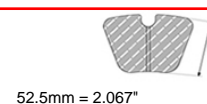
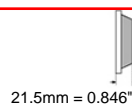
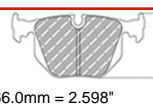
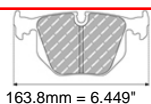

PORSCHE Front

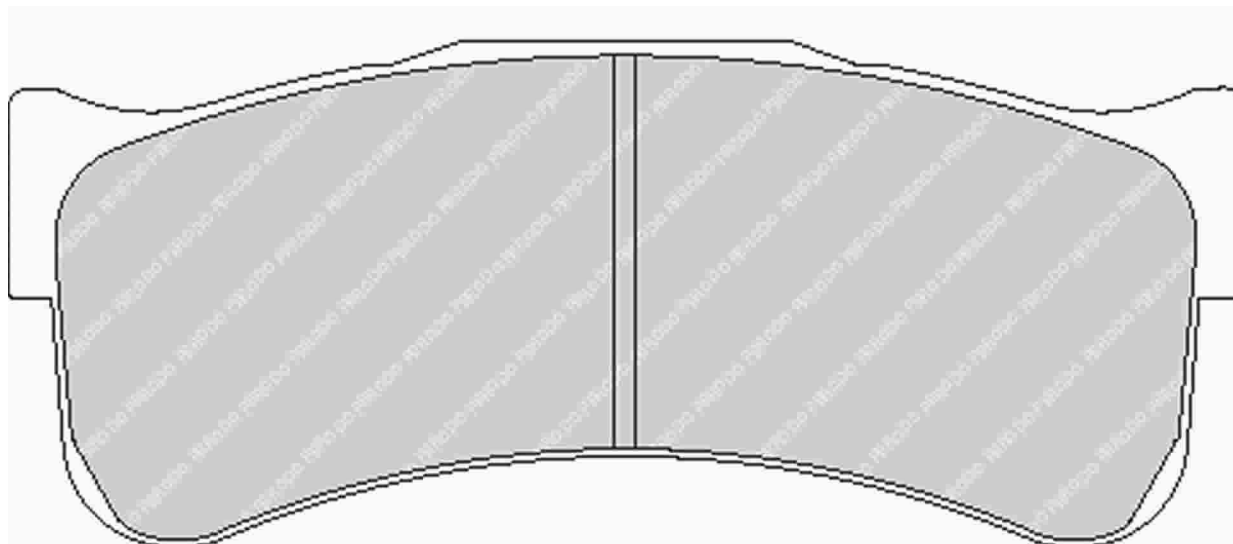

ALSO AVAILABLE		
SHAPE	TH. MM	NOTES
FRP3031	29	
FRP3110	25	

CROSS REFERENCE	
PAGID	8038

MATERIAL AVAILABILITY						
H	C	R	W	WB	Z	ZB

FRP3126



88.0mm = 3.465"



55.0mm = 2.165"



10.0mm = 0.394"

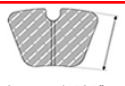

39.0mm = 1.535"

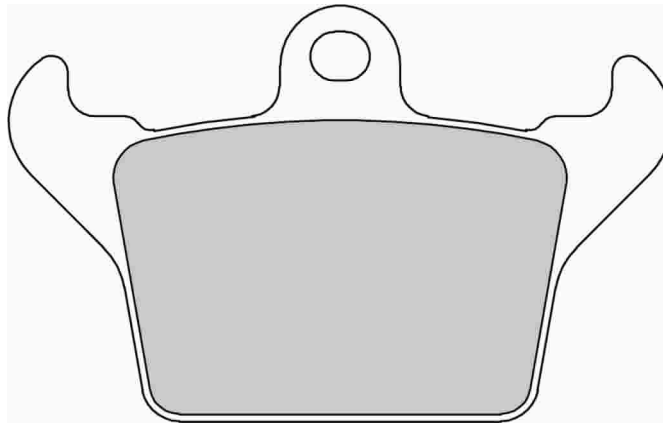

AP Racing/Brembo handbrake

MATERIAL AVAILABILITY						
H	C	R	W	WB	Z	ZB
✓						

FRP3127



145.4mm = 5.724"

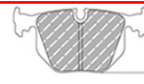

57.8mm = 2.276"



15.5mm = 0.610"

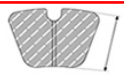

48.0mm = 1.890"

WVA No: 21468 15,50

TOYOTA Front

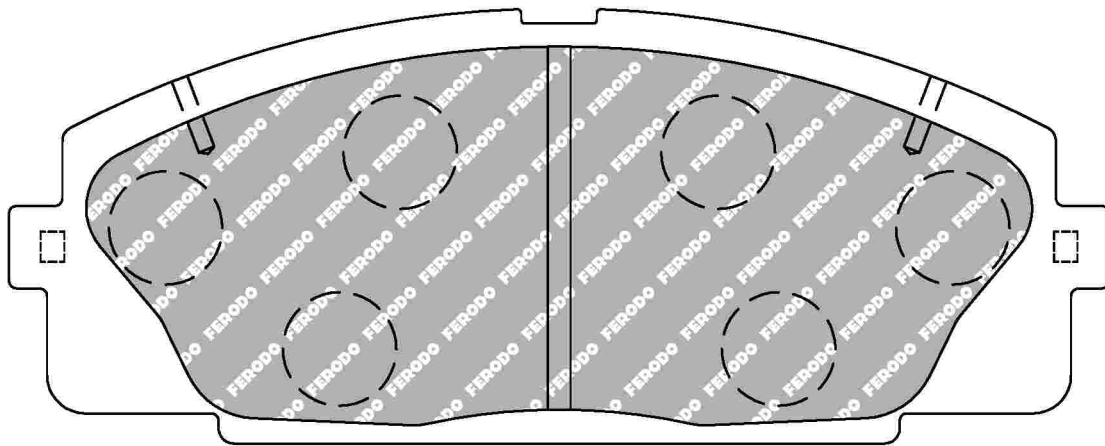

MATERIAL AVAILABILITY						
H	C	R	W	WB	Z	ZB
✓						

CROSS REFERENCE	
AKEBONO	AN - 334K
WVA	21468 15,50

- ✓ Available
- ✗ Out of Range
- ⚠ Exhausting
- 📦 Make to order
- 👤 In Introduction

FRP3128



163.5mm = 6.437"



76.0mm = 2.992"



25.0mm = 0.984"

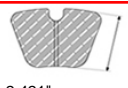

61.5mm = 2.421"

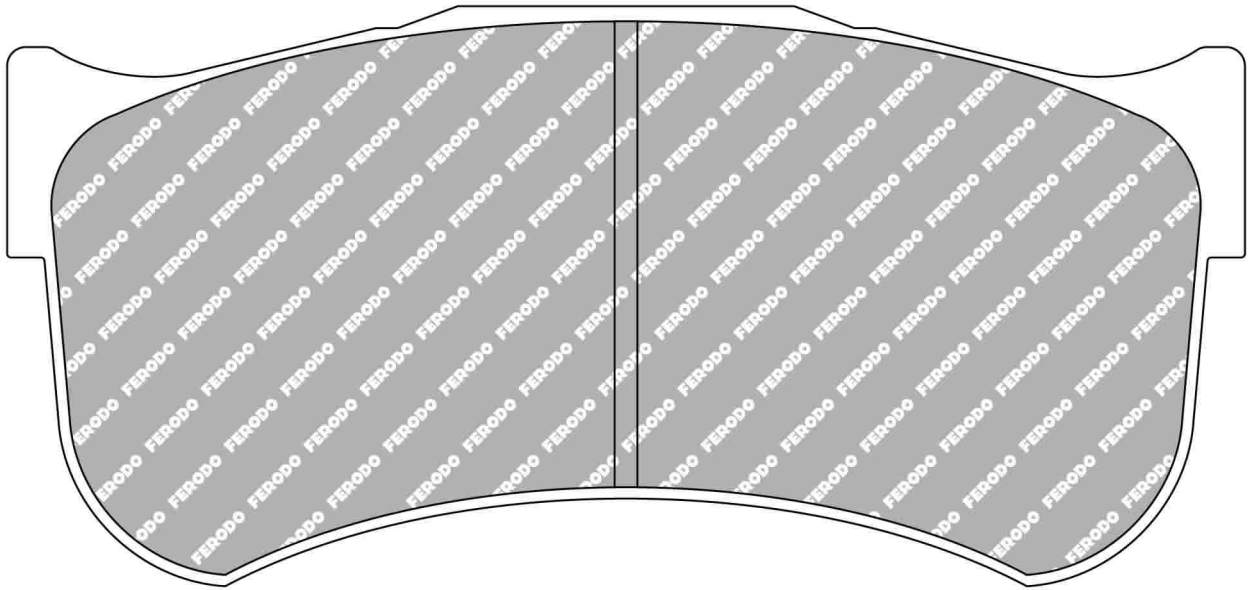

MATERIAL AVAILABILITY						
H	C	R	W	WB	Z	ZB
					✓	☒

CROSS REFERENCE	
PAGID	8101

FRP3129



162.8mm = 6.409"



54.8mm = 2.157"



17.1mm = 0.673"

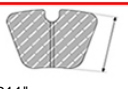

46.0mm = 1.811"

WVA No: 24513
FMSI No: D1081

FORD Front

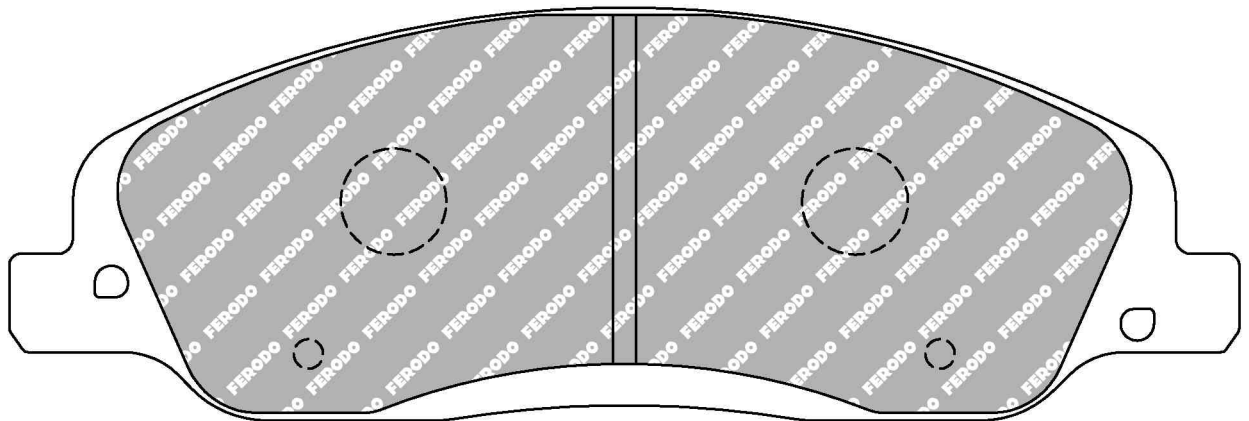

MATERIAL AVAILABILITY						
H	C	R	W	WB	Z	ZB
✓						

CROSS REFERENCE	
FMSI	D1081
HAWK	HB484 0,670
WVA	24513

FRP3130



113.0mm = 4.449"



48.0mm = 1.890"



16.6mm = 0.654"



39.7mm = 1.563"

FMSI No: D1082

FORD Rear

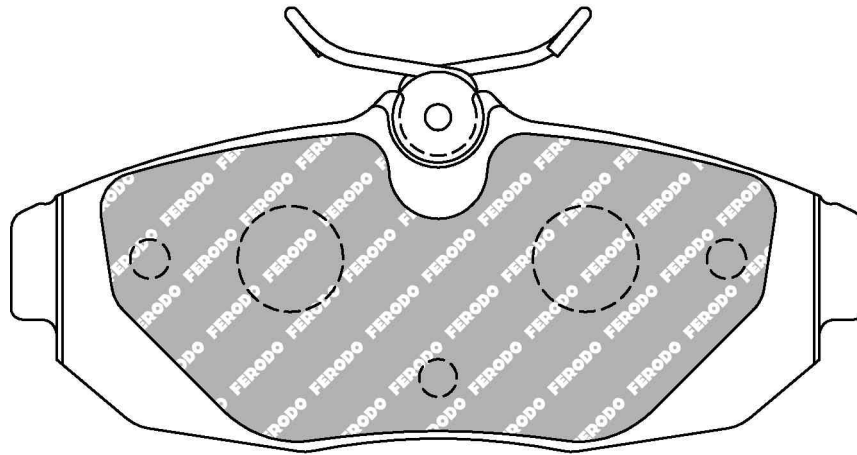

MATERIAL AVAILABILITY						
H	C	R	W	WB	Z	ZB
✓			☒			

CROSS REFERENCE	
FMSI	D1082
HAWK	HB485 0,656
PAGID	8113

FRP3131

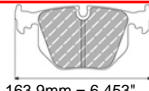

163.9mm = 6.453"



74.7mm = 2.941"



28.0mm = 1.102"



62.0mm = 2.441"

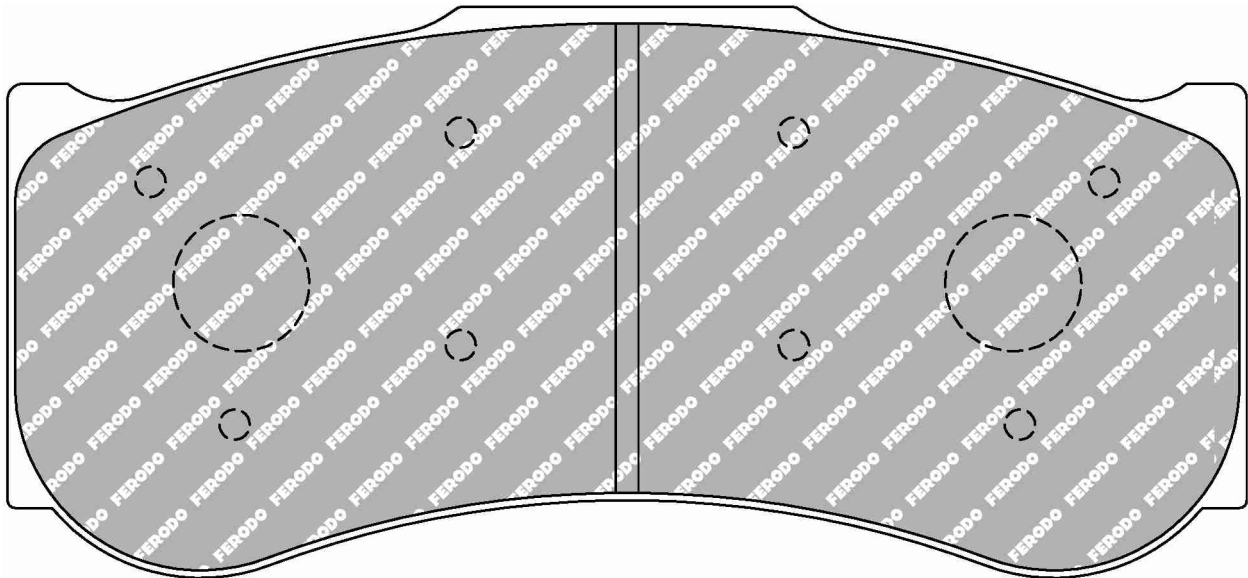

For material availability please contact us

ALSO AVAILABLE		
SHAPE	TH. MM	NOTES
FRP3150	30	

CROSS REFERENCE	
AP RACING	CP6268D62
PAGID	2019

MATERIAL AVAILABILITY						
H	C	R	W	WB	Z	ZB

- ✓ Available
- ✗ Out of Range
- ☒ In Introduction
- ⚠ Exhausting
- ☒ Make to order

FRP3133

WVA No: 24455 16,90

FMSI No: D1405

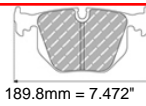

189.8mm = 7.472"

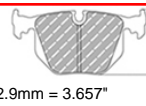

92.9mm = 3.657"



16.5mm = 0.650"



65.0mm = 2.559"

AUDI Front, CADILLAC Front, CHEVROLET Front, JEEP Front, MERCEDES Front

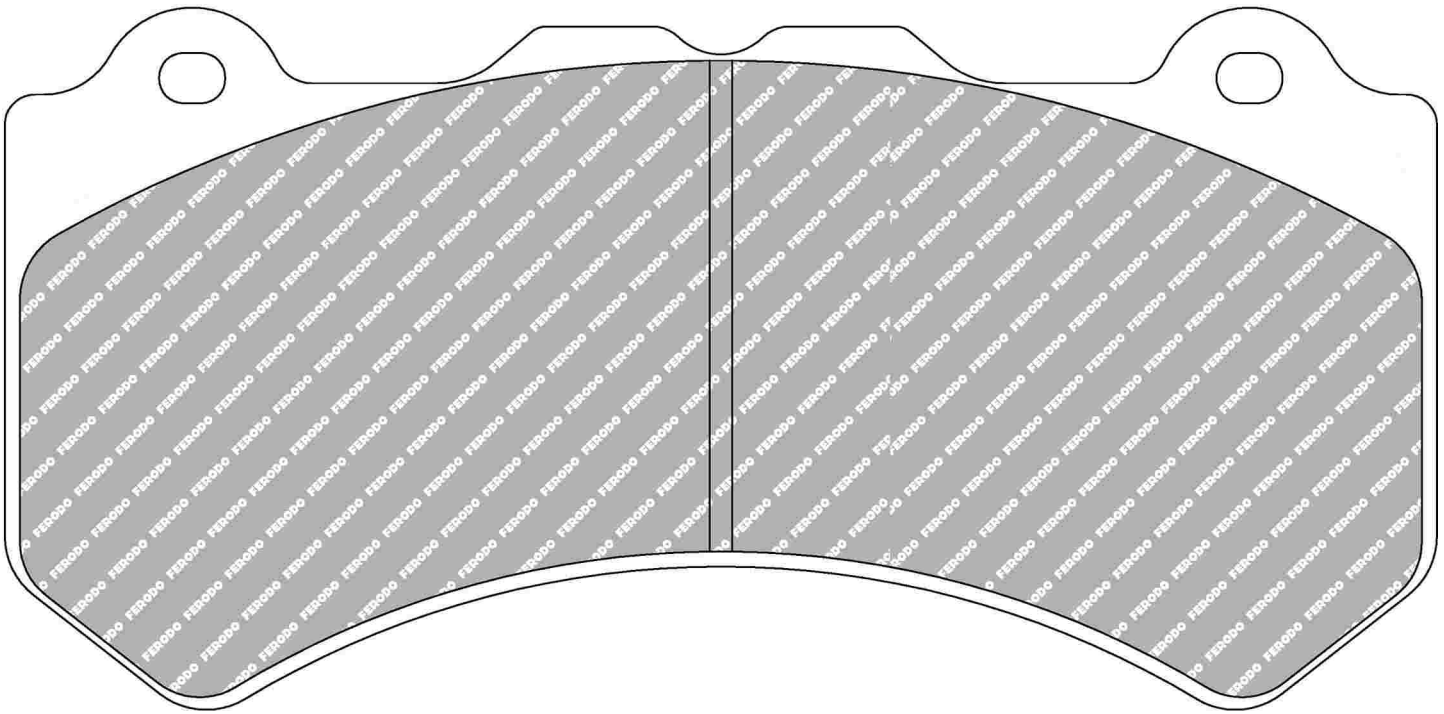

ALSO AVAILABLE

SHAPE	TH. MM	NOTES
FRP3106	18.8	

MATERIAL AVAILABILITY

H	C	R	W	WB	Z	ZB
✓			✓		✉	

CROSS REFERENCE

FMSI	D1405
HAWK	HB649
PAGID	8081
WVA	24455 16,90

FRP3134

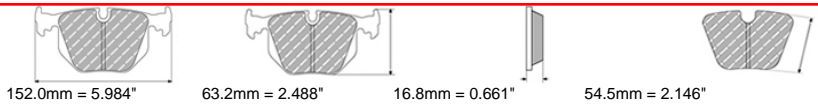

JAGUAR Front

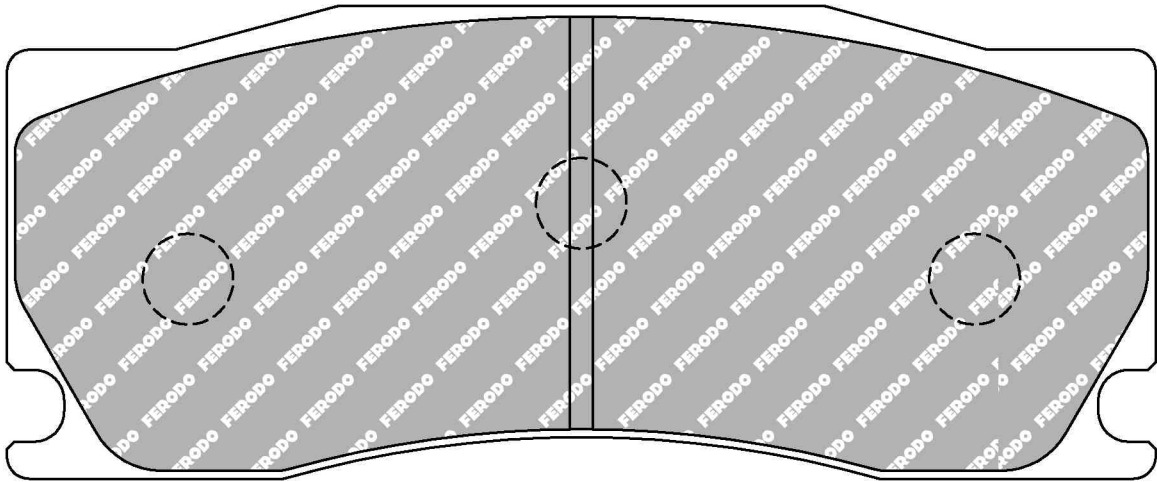

MATERIAL AVAILABILITY						
H	C	R	W	WB	Z	ZB
✓		✗			✓	

CROSS REFERENCE	
ALCON	PNF4497X831S

FRP3135

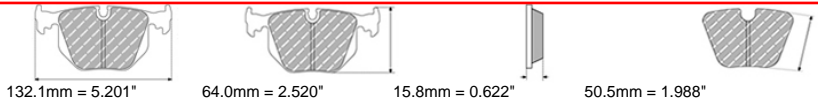

WVA No: 24851 15,60

JAGUAR Rear, PEUGEOT Front

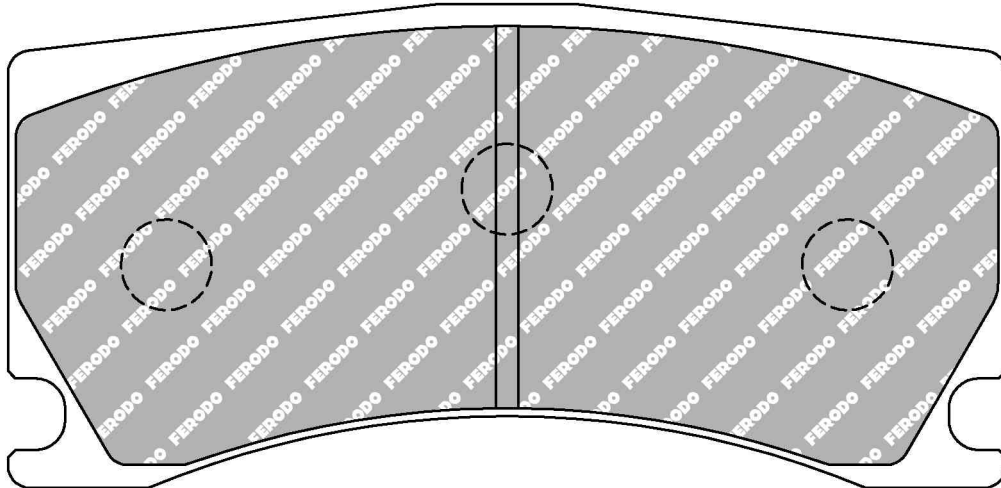

MATERIAL AVAILABILITY						
H	C	R	W	WB	Z	ZB
✓		✗			✗	

CROSS REFERENCE	
ALCON	PNF4498X821S
WVA	24851 15,60

✓ Available ⚠ Exhausting
 ✗ Out of Range ✉ Make to order
 ⓘ In Introduction

FRP3136



175.6mm = 6.913"



93.2mm = 3.669"



16.9mm = 0.665"



69.0mm = 2.717"

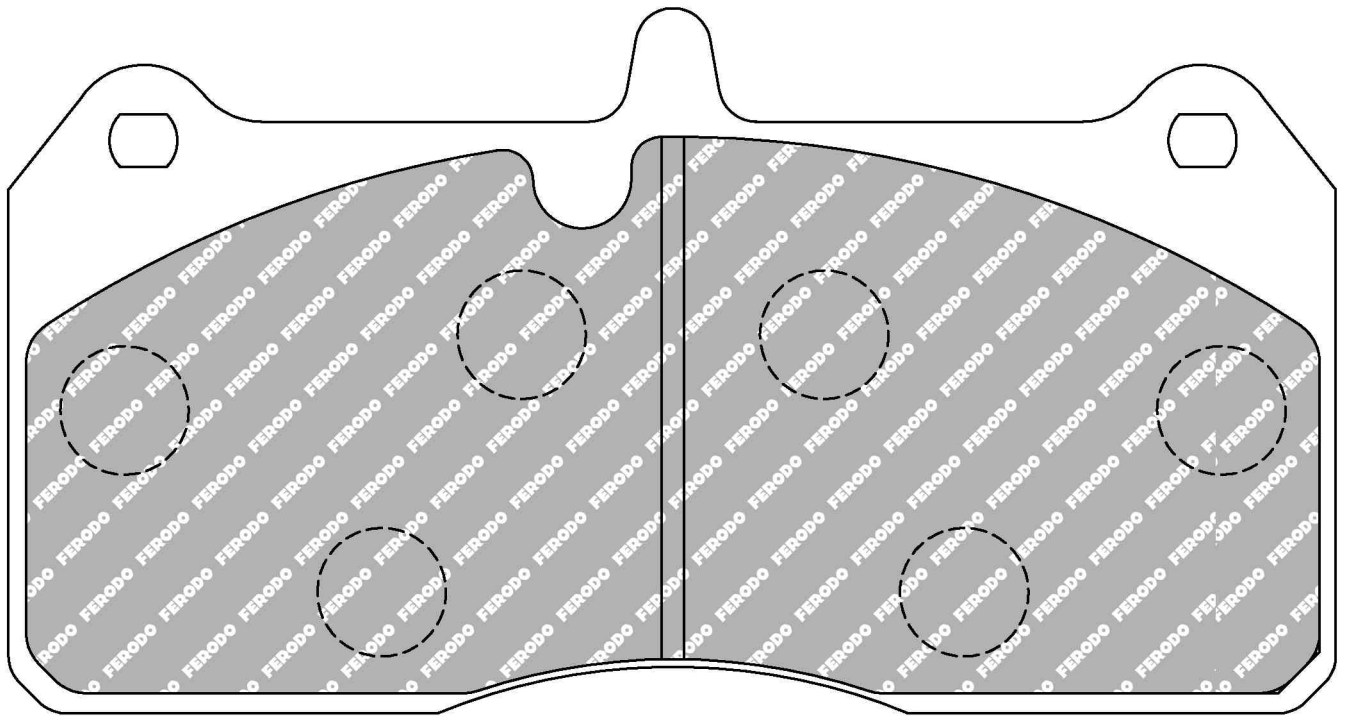

MATERIAL AVAILABILITY

H	C	R	W	WB	Z	ZB
✓		✉				

CROSS REFERENCE

AP RACING	CP8318D70
-----------	-----------

FRP3137

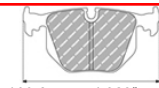

109.8mm = 4.323"



63.0mm = 2.480"



16.0mm = 0.630"

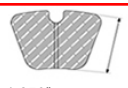

47.0mm = 1.850"

CHEVROLET Rear

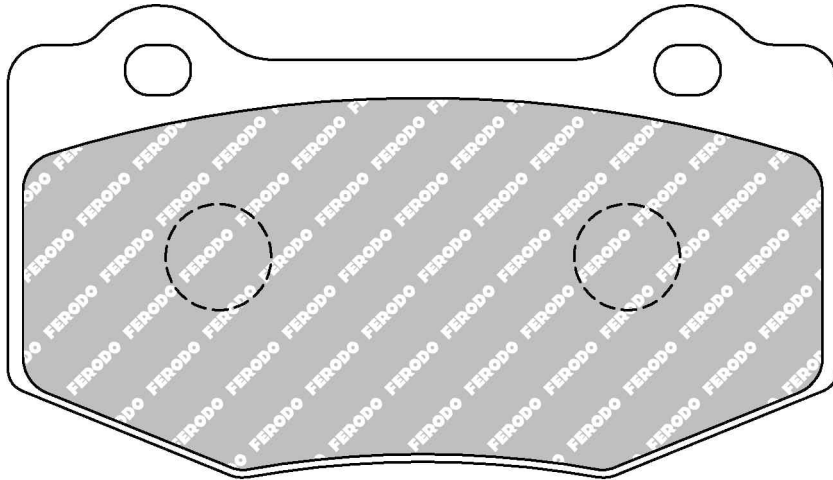

MATERIAL AVAILABILITY						
H	C	R	W	WB	Z	ZB
✓			✉		✉	

CROSS REFERENCE	
PAGID	8208

FRP3138



163.1mm = 6.421"



68.8mm = 2.709"



30.0mm = 1.181"

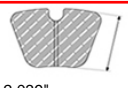

51.8mm = 2.039"

MCLAREN Front

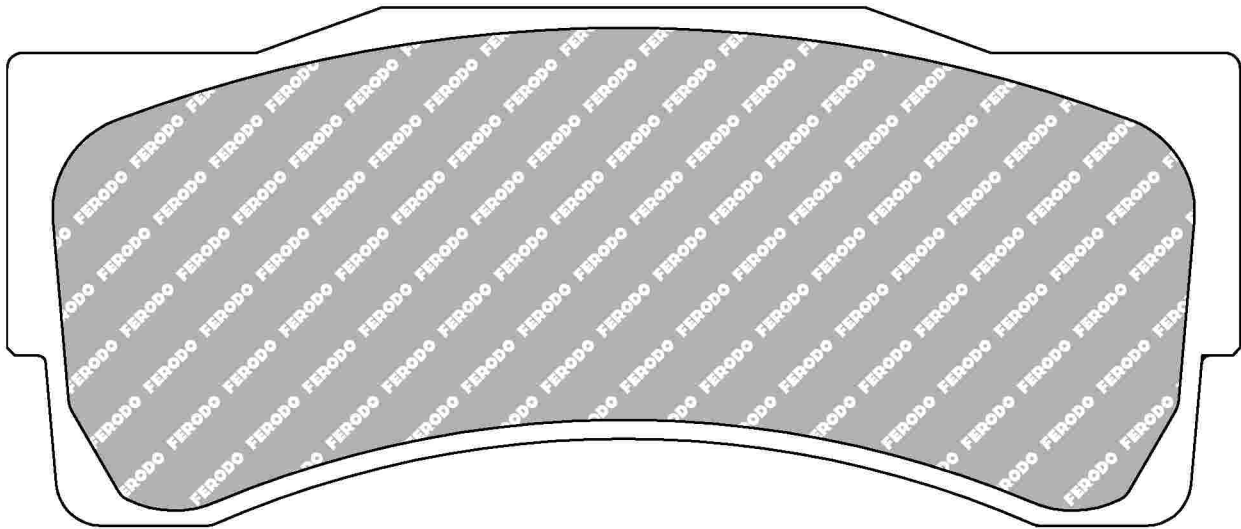

MATERIAL AVAILABILITY						
H	C	R	W	WB	Z	ZB
					✗	✉

- ✓ Available
- ✗ Out of Range
- ✉ Make to order
- ⓘ In Introduction
- ⚠ Exhausting

FRP3139



131.8mm = 5.189"



62.2mm = 2.449"



25.0mm = 0.984"



46.5mm = 1.831"

MCLAREN Rear

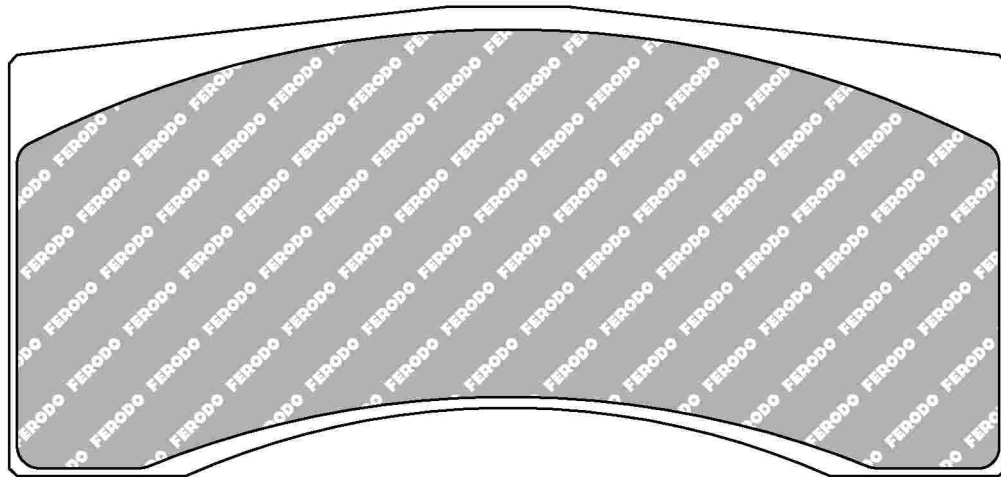

MATERIAL AVAILABILITY

H	C	R	W	WB	Z	ZB
					✘	☑

FRP3140

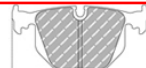

139.8mm = 5.504"

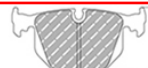

61.4mm = 2.417"



16.0mm = 0.630"



48.4mm = 1.906"

FORD Front / Rear

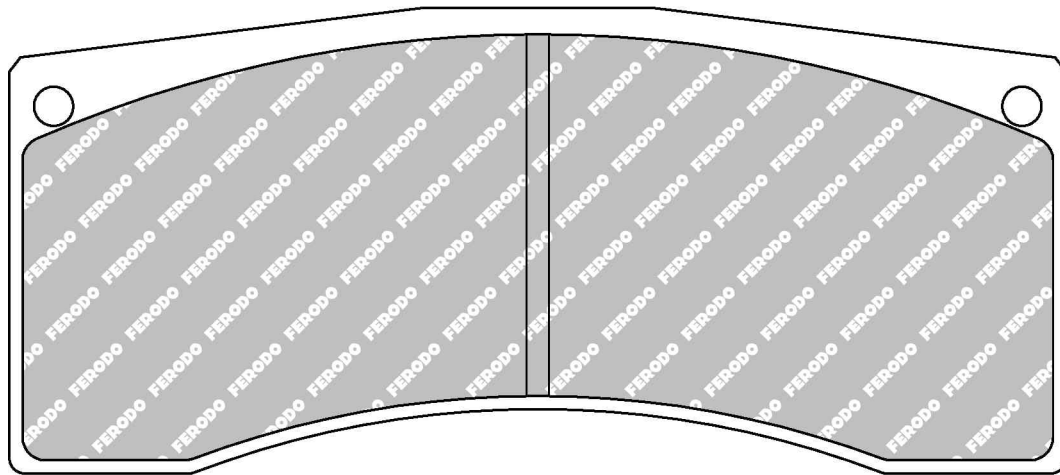

ALSO AVAILABLE

SHAPE	TH. MM	NOTES
FRP3024	20	
FRP3029	26	
FRP3030	28	
FRP3087	17.5	

CROSS REFERENCE

AP RACING	CP6820D48
PAGID	1616
PAGID	1616
PAGID	1617
PAGID	1617

MATERIAL AVAILABILITY

H	C	R	W	WB	Z	ZB
		☑			☑	

3334

FERODO

RACING
Updated on 17th Aug 2018

☑ Available
 ⚠ Exhausting
✘ Out of Range
 ☑ Make to order
⚡ In Introduction

FRP3141

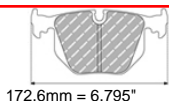

172.6mm = 6.795"

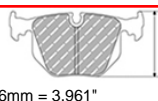

100.6mm = 3.961"



15.0mm = 0.591"



65.5mm = 2.579"

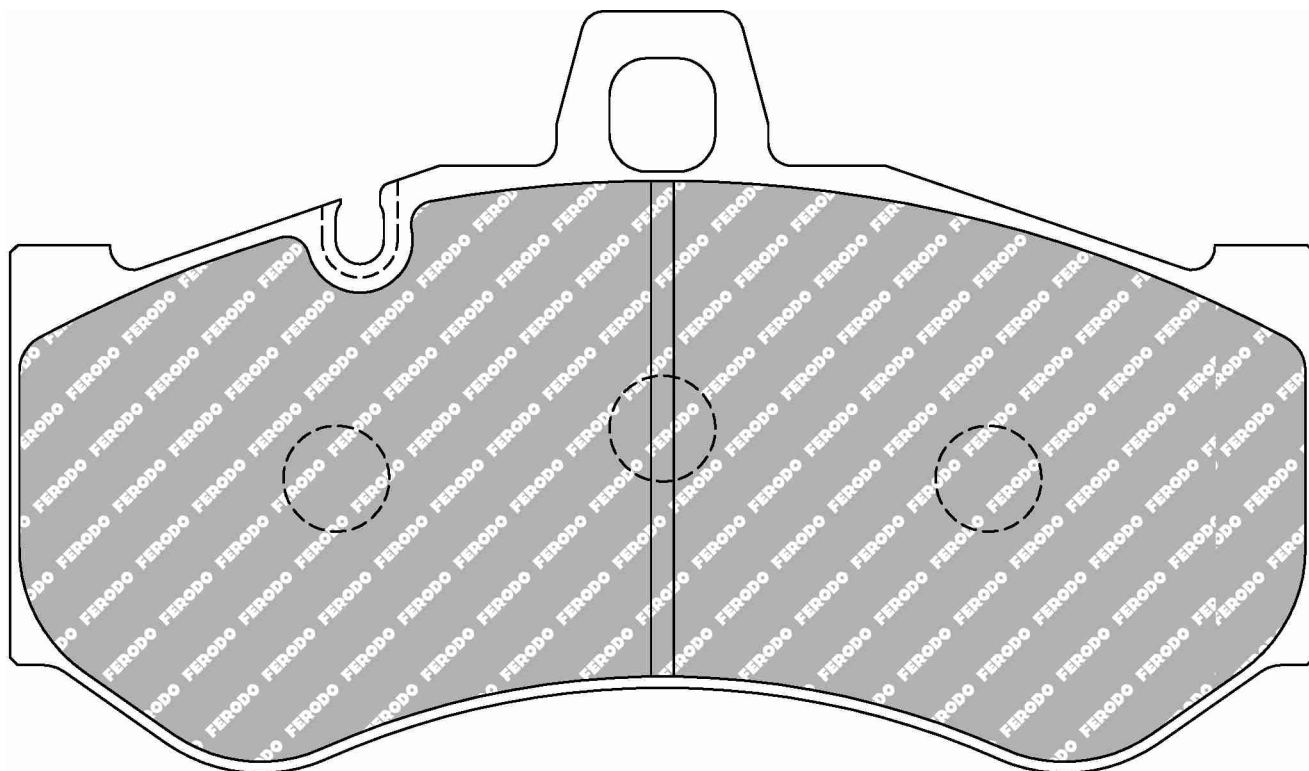

Front Pads for Alcon upgrade kits

MATERIAL AVAILABILITY						
H	C	R	W	WB	Z	ZB
✓						

CROSS REFERENCE	
ALCON	PNF4488X920
PAGID	8043

- ✓ Available
- ✗ Out of Range
- ⚠ Exhausting
- 📦 Make to order
- 👤 In Introduction

FRP3142

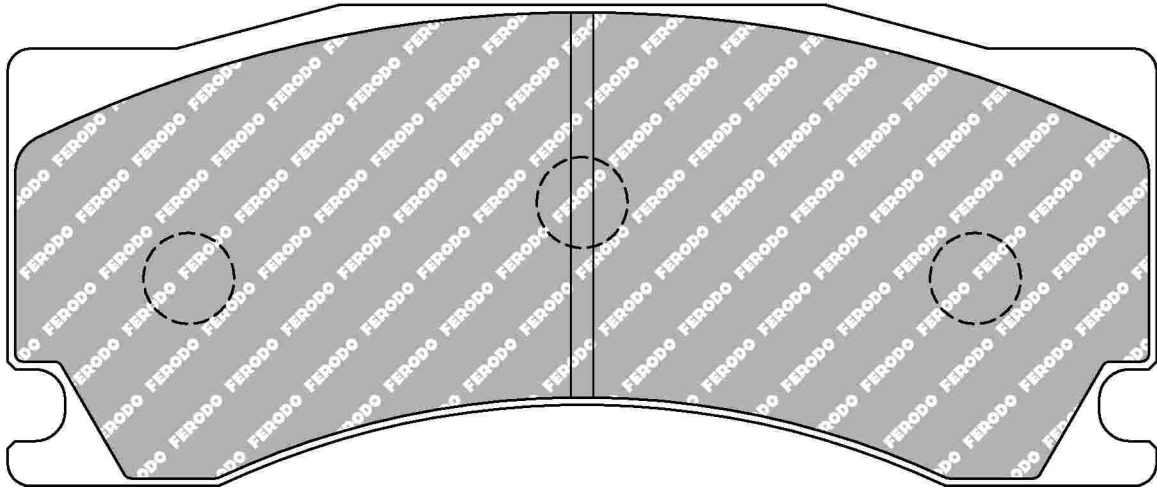
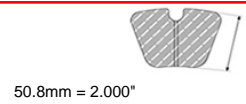
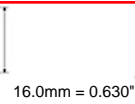
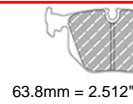
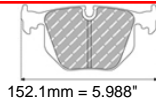

Front Pads for Alcon upgrade kits

ALSO AVAILABLE

SHAPE	TH. MM	NOTES
FRP3081		For Alcon Kits without caliper pin guides

CROSS REFERENCE

ALCON	PNF4479X560
-------	-------------

MATERIAL AVAILABILITY

H	C	R	W	WB	Z	ZB
✓						

FRP3143



130.2mm = 5.126"



70.0mm = 2.756"



17.0mm = 0.669"

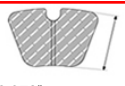

60.4mm = 2.378"

PORSCHE Rear

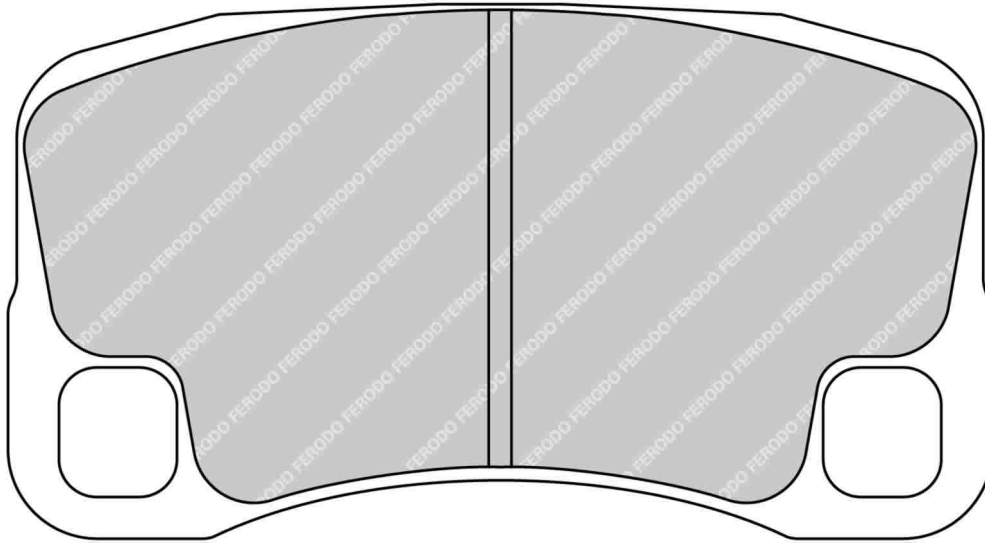

ALSO AVAILABLE		
SHAPE	TH. MM	NOTES
FRP3095	19.0	

MATERIAL AVAILABILITY						
H	C	R	W	WB	Z	ZB

CROSS REFERENCE	
MINTEX	MDB2937
PAGID	8008
PAGID	T1752

Available
 Out of Range
 In Introduction
 Exhausting
 Make to order

FRP3144



152.1mm = 5.988"



68.9mm = 2.713"



18.0mm = 0.709"

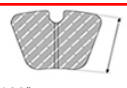

54.0mm = 2.126"

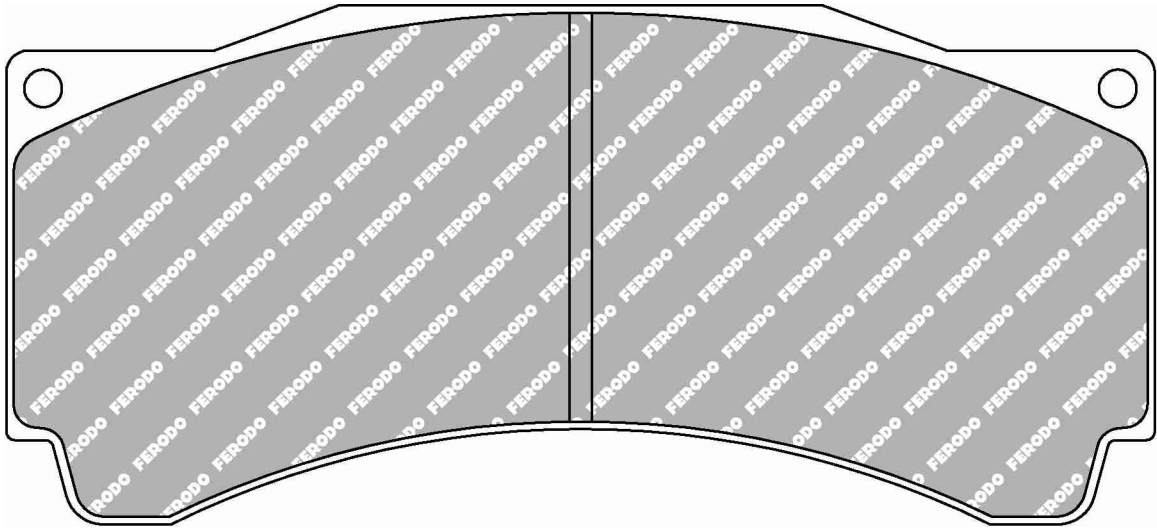

ALSO AVAILABLE

SHAPE	TH. MM	NOTES
FRP3003	18	with top tab
FRP3014	25	without top tab
FRP3015	28.5	without top tab
FRP3077	17	with top tab
FRP3145	17	without top tab

CROSS REFERENCE

AP RACING	CP3905D54
PAGID	1904

MATERIAL AVAILABILITY

H	C	R	W	WB	Z	ZB
✓		✓	✗	✓	✗	✓

FRP3145



152.1mm = 5.988"



68.9mm = 2.713"



17.0mm = 0.669"

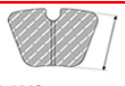

54.0mm = 2.126"

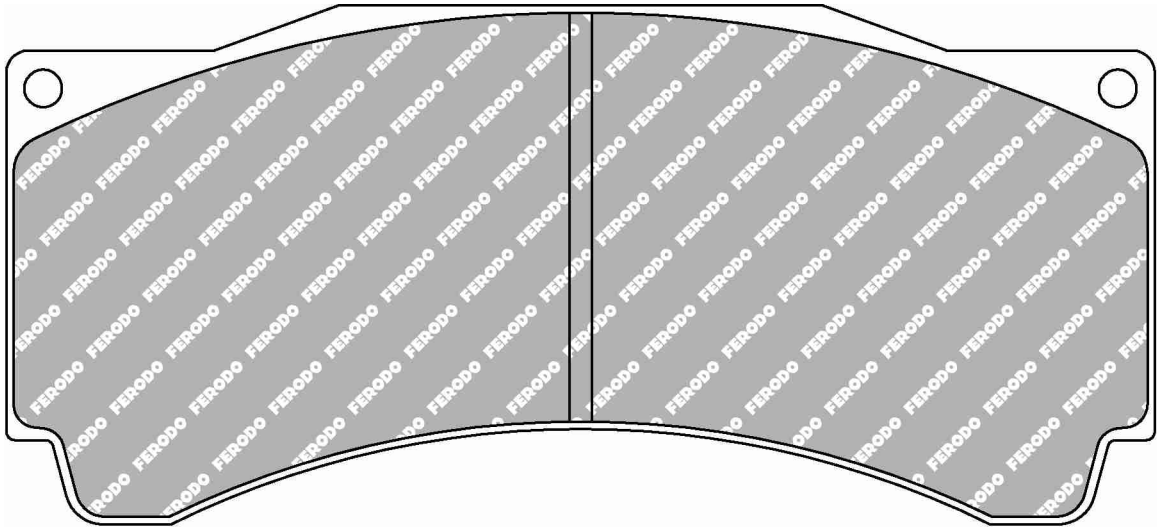

ALSO AVAILABLE

SHAPE	TH. MM	NOTES
FRP3003	18	with top tab
FRP3014	25	without top tab
FRP3015	28.5	without top tab
FRP3077	17	with top tab
FRP3144	18	without top tab

MATERIAL AVAILABILITY

H	C	R	W	WB	Z	ZB

Available
 Out of Range
 In Introduction
 Exhausting
 Make to order

FRP3146

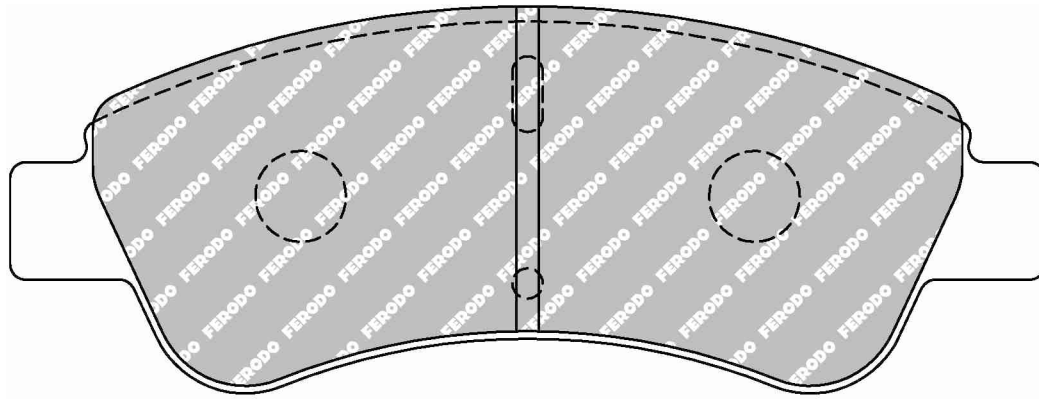
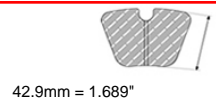
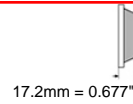
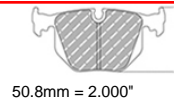
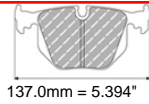

ALSO AVAILABLE		
SHAPE	TH. MM	NOTES
FCP1399	19.0	

MATERIAL AVAILABILITY						
H	C	R	W	WB	Z	ZB

FRP3147



175.6mm = 6.913"



100.8mm = 3.969"



16.9mm = 0.665"

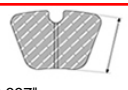

68.5mm = 2.697"

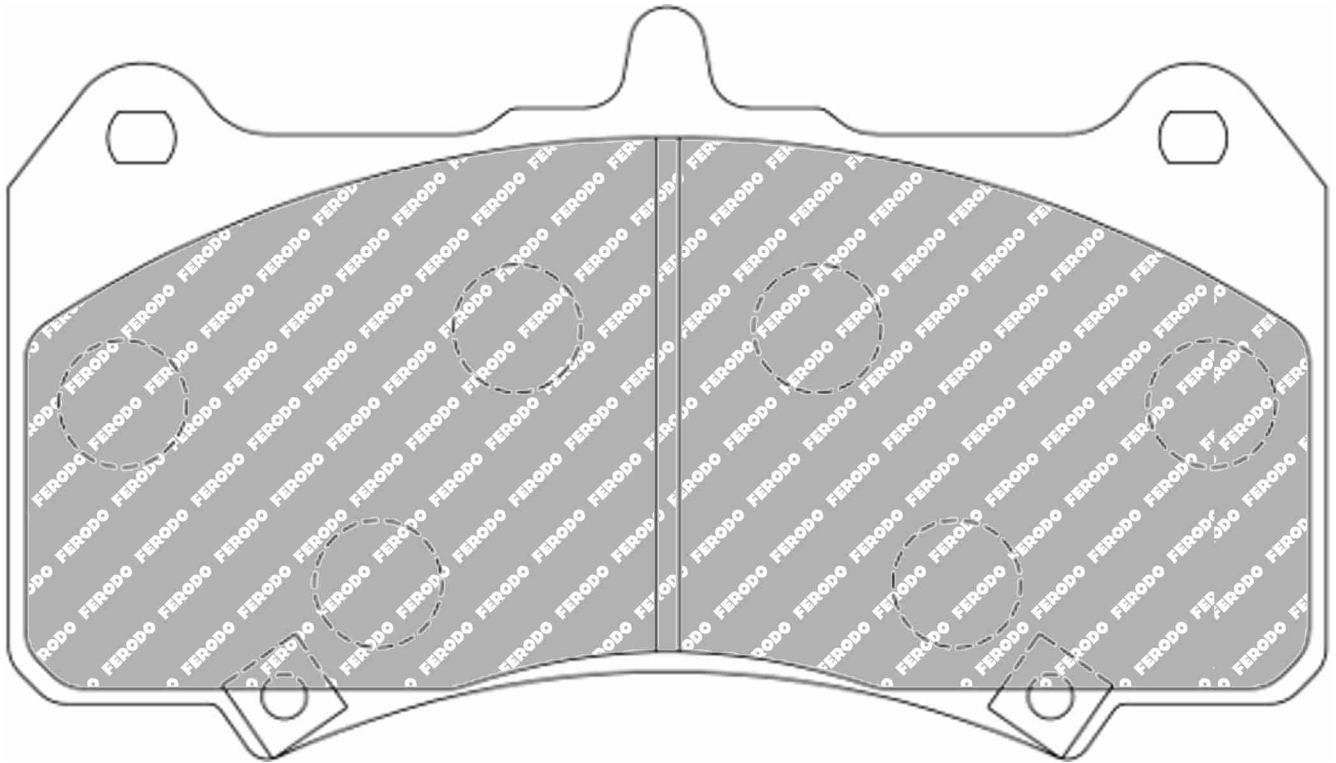

MATERIAL AVAILABILITY

H	C	R	W	WB	Z	ZB
✓			✓			

CROSS REFERENCE

AP RACING	CP7555D70
-----------	-----------

✓ Available ⚠ Exhausting
 ✗ Out of Range 📦 Make to order
 ⓘ In Introduction

FRP3148

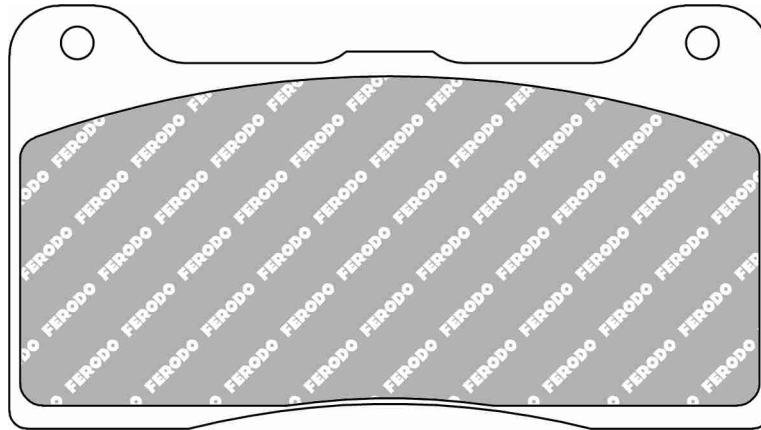
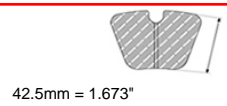
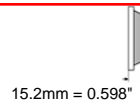
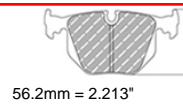
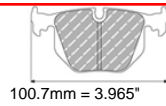

MATERIAL AVAILABILITY						
H	C	R	W	WB	Z	ZB
✓		✓				

CROSS REFERENCE	
EBC	DP4039R
EBC	DP5039NDX
EBC	DP9039
HAWK	HB542x.600
P.MU	F1103
PAGID	2581USA

FRP3149

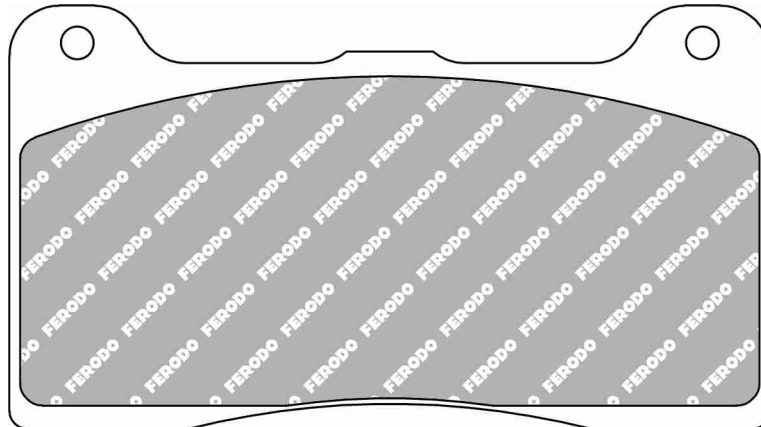
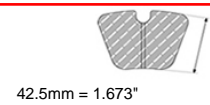
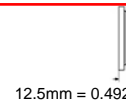
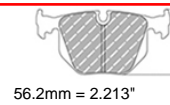
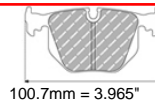

MATERIAL AVAILABILITY						
H	C	R	W	WB	Z	ZB
✓		✓				

CROSS REFERENCE	
Wilwood	7812

FRP3150



163.9mm = 6.453"



74.7mm = 2.941"



30mm = 1.181"

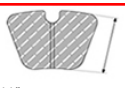

62mm = 2.441"

BMW Front

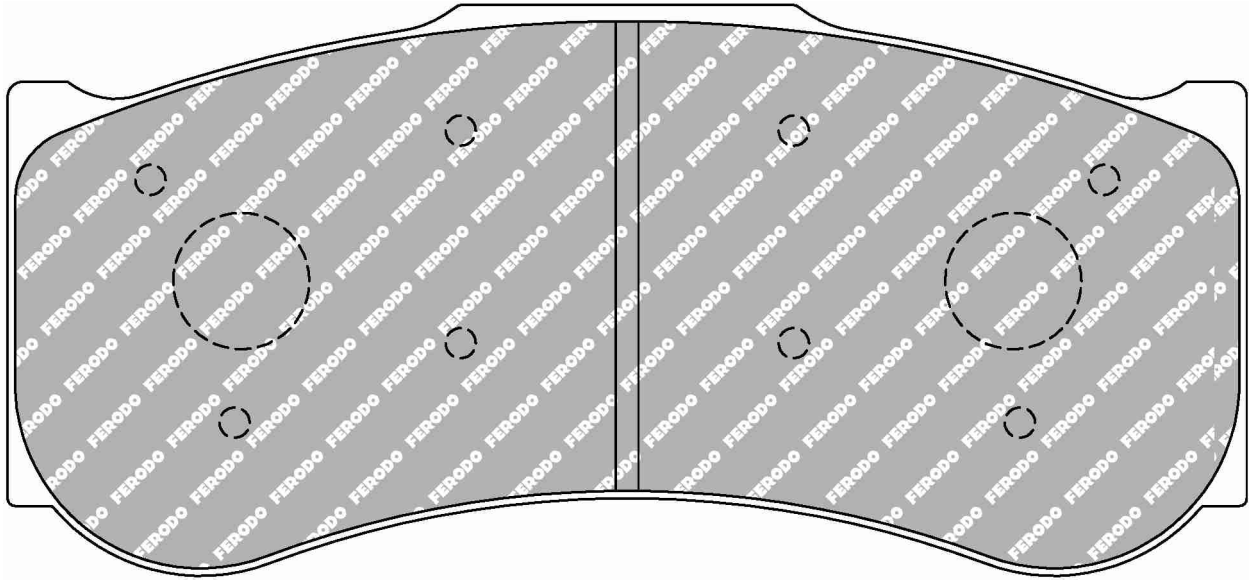

For material availability please contact us

ALSO AVAILABLE

SHAPE	TH. MM	NOTES
FRP3131	28	

CROSS REFERENCE

AP RACING	CP6276D62
PAGID	2019

MATERIAL AVAILABILITY

H	C	R	W	WB	Z	ZB

Available
 Out of Range
 In Introduction
 Exhausting
 Make to order

FERODO
RACING
 Updated on 17th Aug 2018

3343

FRP5001

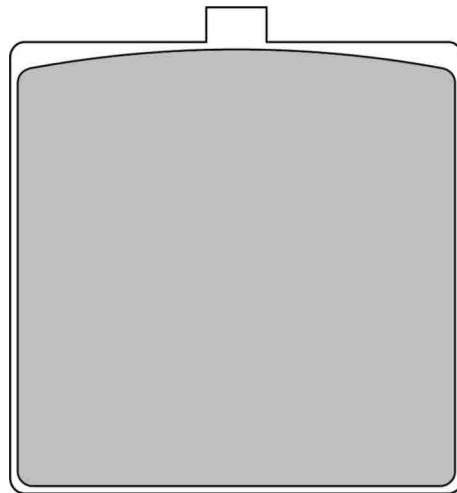
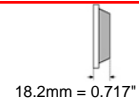
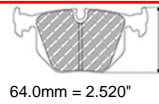
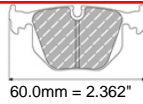

MGB705:PLEASE NOTE that this pad can be cut to fit MGB704 (rear caliper)

MATERIAL AVAILABILITY						
H	C	R	W	WB	Z	ZB

FRP5002

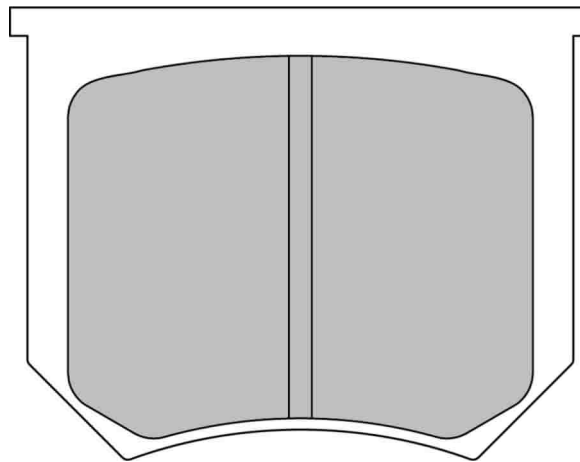
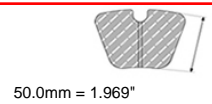
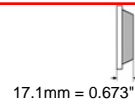
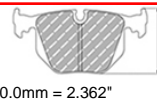
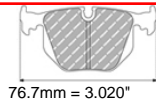

LOTUS Front / Rear

GD504:Historical Cars

MATERIAL AVAILABILITY						
H	C	R	W	WB	Z	ZB

CROSS REFERENCE	
EBC	DP2035
PAGID	8032

FERODO[®]

**BRAKE PADS XREF
COMPETITORS TO FERODO**



FERODO[®]

RACING

BRAKE PADS X-REF

COMPETITORS TO FERODO

AKEBONO	Ferodo	ALCON	Ferodo	AP RACING	Ferodo	BREMBO	Ferodo
AN - 334K	FRP3127	PNF4441X757.4	FRP302	CP2749D55 (28 mm)	FRP3060	07.4865.1	FCP1281
		PNF4441X769.4	FRP1077	CP2749D66 (28 mm)	FRP3059	07.4865.80	FCP1281
ALCON	Ferodo	PNF4463X529	FRP219	CP3215D42	FRP3018	07.5064.27	FRP308
3435	FRP101	PNF4463X529.4	FRP219	CP3215D46	FRP3091	07.5064.49	FRP1079
PNF0084X222	FRP3027	PNF4463X551	FRP218	CP3215D50	FRP216	07.5064.7	FRP308
PNF0084X222.4	FRP3027	PNF4463X551.4	FRP218	CP3345D44	FRP219	07.5064.72	FRP308
PNF0084X232.4	FCP1280	PNF4463X554	FRP201	CP3558D46	FRP1060	07.5064.73	FRP308
PNF0084X233.4	FCP1281	PNF4463X554.4	FRP201	CP3558D51	FRP3061	07.5064.8	FRP1079
PNF0084X235	FCP685	PNF4463X572	FRP219	CP3558D54	FRP3014	07.5064.82	FRP1079
PNF0084X235.4	FCP685	PNF4463X581.4	FRP201	CP3714D54	FRP217	07.5064.84	FRP1079
PNF0084X236.4	FCP1283	PNF4476X545	FRP3009	CP3796D54	FRP3006	07.5139	FRP3032
PNF0084X238.4	FCP767	PNF4476X545.4	FRP3009	CP3894D46	FRP3000	07.5139.0	FRP1077
PNF0084X245.4	FRP216	PNF4476X549	FRP3012	CP3894D51 (18 mm)	FRP3054	07.5139.07	FRP1077
PNF0084X249.4	FCP986	PNF4476X549.4	FRP3012	CP3894D54	FRP3003	07.5139.19	FRP1077
PNF0084X261.4	FCP558	PNF4479X560	FRP3142	CP3905D54	FRP3144	07.5139.3	FRP1078
PNF0084X262.4	FCP845	PNF4488X920	FRP3141	CP3915D33	FCP1560	07.5139.34	FRP1078
PNF0084X264.4	FRP201	PNF4489X519.4	FRP3000	CP4140D36	FRP3001	07.5139.6	FRP302
PNF0084X268.4	FCP1334	PNF4489X532.4	FRP3003	CP4296D43	FRP1061	07.5139.65	FRP302
PNF0084X276.4	FRP3018	PNF4489X543	FRP3015	CP4595D54	FRP3015	07.5139.69	FRP302
PNF0084X282.4	FRP1064	PNF4489X545.4	FRP3054	CP4751D43	FRP501	07.5139.81	FRP1078
PNF0084X283.4	FRP3004	PNF4489X562.4	FRP3000	CP4848D46 (18 mm)	FRP3086	07.5139.85	FRP3032
PNF0084X284	FRP502	PNF4489X565.4	FRP3000	CP5070D51	FRP3076	07.5139.88	FRP3032
PNF0084X284.4	FRP502	PNF4493X501.4	FRP3026	CP5070D54	FRP3077	07.5146.30	FCP1348
PNF0084X298.4	FCP1372	PNF4493X502	FRP3026	CP5119D50	FCP1562	07.5146.31	FCP1348
PNF0084X299.4	FCP1133	PNF4493X503	FRP3026	CP5119D50	FRP3056	07.5169.9	FRP3024
PNF0084X305.4	FRP3025	PNF4493X603	FRP3044	CP5148D46	FRP3020	07.5169.90	FRP3024
PNF0084X317.4	FCP558	PNF4493X603.12	FRP3044	CP5148DXX	FRP3086	07.5169.92	FRP3024
PNF0084X321.4	FCP1378	PNF4493X603.4	FRP3044	CP5788D48	FRP3024	07.5308.9	FRP3042
PNF0084X322.4	FRP1079	PNF4493X610.12	FRP3044	CP5805D45	FRP503	07.5308.91	FRP3042
PNF0084X325.4	FCP1081	PNF4493X610.4	FRP3044	CP6070D49	FRP1078	07.5505.91	FCP1562
PNF0084X331	FRP216	PNF4495X501.4	FRP3039	CP6210D54 (28 mm)	FRP3037	07.5684.2	FRP1058
PNF0084X331.4	FRP216	PNF4495X514.4	FRP3037	CP6210D54 (30 mm)	FRP3055	07.5684.2	FRP1064
PNF0084X336.4	FRP3067	PNF4495X516.4	FRP3037	CP6230D54 (25 mm)	FRP3039	07.5684.25	FRP1064
PNF0084X347.4	FCP857	PNF4495X517.4	FRP3055	CP6268D62	FRP3131	07.5684.26	FRP1064
PNF0084X350.4	FRP503	PNF4495X518.4	FRP3055	CP6276D62	FRP3150	07.5684.5	FRP3022
PNF0084X358.4	FCP1562	PNF4497X607.4	FRP3081	CP6600D50	FRP3107	07.5684.5	FRP3023
PNF0084X359.4	FCP1334	PNF4497X617.4	FRP3081	CP6600D55	FRP3083	07.5684.52	FRP3022
PNF0084X363.4	FCP1636	PNF4497X831S	FRP3134	CP6627D51	FRP3115	07.5684.53	FRP3023
PNF3430X275.4	FRP3043	PNF4498X703.4	FRP3082	CP6820D48	FRP3140	07.5684.55	FRP3023
PNF3451X521.4	FCP809	PNF4498X705.4	FRP3082	CP7031D32	FRP3102	07.5684.56	FRP3022
PNF3451X522	FCP810	PNF4498X821S	FRP3135	CP7040D54	FRP3114	07.5684.8	FRP3033
PNF3451X522.4	FCP810			CP7040D61	FRP3084	07.5684.80	FRP3033
PNF3451X554.4	FCP810	AP RACING	Ferodo	CP7555D70	FRP3147	07.5684.81	FRP3033
PNF3451X555.4	FCP809	CP2195D38	FCP342	CP7600D46	FRP3085	07.5868	FRP1059
PNF3451X566.4	FCP810	CP2270D50	FRP203	CP8250-D41	FRP3097	07.5868.2	FRP3004
PNF4436X508.4	FCP451	CP2279D42	FRP3073	CP8250D50	FRP3116	07.5868.29	FRP3004
PNF4436X509	FRP3069	CP2279D50	FRP212	CP8310D70	FRP3027	07.6953.9	FCP1348
PNF4436X509.4	FRP3069	CP2340D38	FRP3021	CP8318D70	FRP3136	07.6955.3	FRP3053
PNF4441X723	FRP1077	CP2340D43	FRP218			07.6955.30	FRP3053
PNF4441X723.4	FRP1077	CP2340D51	FRP201	ATE	Ferodo	07.6955.31	FRP3053
PNF4441X728	FRP302	CP2373	FRP202	13.0470-7167.2	FCP1628	07.6955.50	FRP3088
PNF4441X728.4	FRP302	CP2382	FRP202			07.7235.60	FCP721
PNF4441X753	FRP1077	CP2383	FRP202	BOSCH	Ferodo	07.7275.68	FCP1334
PNF4441X753S.4	FRP1077	CP2384	FRP202	0986494659	FCP4434	07.7293.6	FRP3031
PNF4441X754	FRP302	CP2399D43	FCP825			07.7293.60	FRP3031
PNF4441X754.4	FRP302	CP2712D44	FCP840	BREMBO	Ferodo	07.7293.61	FRP3031
				07.1715.50	FCP2		

BRAKE PADS X-REF

COMPETITORS TO FERODO

BREMBO	Ferodo	BREMBO	Ferodo	BREMBO	Ferodo	CL BRAKES	Ferodo
07.7293.63	FRP3031	07.8301.05	FCP360	07.8301.65	FCP1295	4009	FCP105
07.7293.7	FRP3110	07.8301.06	FCP370	07.8301.68	FCP725	4010	FCP596
07.7293.70	FRP3031	07.8301.07	FCP385	07.8301.69	FCP850	4011	FCP774
07.7614.2	FRP3040	07.8301.08	FCP392	07.8301.71	FCP774	4011	FCP775
07.7614.20	FRP3040	07.8301.09	FCP393	07.8301.72	FCP1318	4014	FCP399
07.7614.21	FRP3040	07.8301.10	FCP406	07.8301.73	FCP590	4016	FCP206
07.7614.3	FRP3046	07.8301.11	FCP409	07.8301.74	FCP1334	4018	FCP789
07.7614.30	FRP3046	07.8301.12	FCP392	07.8301.76	FCP1368	4019	FCP790
07.7614.31	FRP3046	07.8301.13	FCP434	07.8301.77	FCP1376	4020	FCP1133
07.7810.1	FRP3035	07.8301.14	FCP519	07.8301.78	FCP1378	4021	FCP385
07.7810.10	FRP3035	07.8301.15	FCP524	07.8301.79	FCP1467	4021	FCP392
07.7810.11	FRP3035	07.8301.16	FCP535	07.8301.80	FCP1468	4022	FCP721
07.7810.2	FRP3034	07.8301.17	FCP541	07.8301.84	FRP3067	4023	FCP276
07.7810.20	FRP3034	07.8301.18	FCP565	07.8301.88	FCP1499	4023	FCP1323
07.7810.21	FRP3034	07.8301.19	FCP584	07.8301.89	FCP1573	4025	FCP256
07.7810.3	FRP3045	07.8301.21	FCP596	07.8301.90	FCP1444	4027	FCP565
07.7810.30	FRP3045	07.8301.21	FCP1676	07.8301.91	FCP1543	4028	FCP370
07.7810.31	FRP3045	07.8301.22	FCP598	07.8301.92	FCP1568	4029	FCP1327
07.7858.30-40	FCP1562	07.8301.23	FCP600	07.8365.33	FRP3100	4031	FCP1068
07.7859.1	FRP3029	07.8301.24	FCP602	07.8590.15	FRP3106	4032	FCP850
07.7859.10	FRP3029	07.8301.25	FCP613	07.8645.16	FCP1281	4033	FCP779
07.7859.11	FRP3029	07.8301.26	FCP617	07.8715.36	FRP3067	4033	FCP1073
07.7859.2	FRP3030	07.8301.28	FCP685	07.8720.XX	FCP1348	4034	FCP558
07.7859.20	FRP3030	07.8301.29	FCP732	07.9184.45	FCP1298	4035	FCP408
07.7859.21	FRP3030	07.8301.30	FCP766	07.9209.xx	FRP3100	4036	FCP584
07.7859.60	FRP3087	07.8301.31	FCP767	07.9312.44	FCP1664	4037	FCP586
07.7859.70	FRP3087	07.8301.32	FCP774	07.9312.45	FCP1664	4038	FCP541
07.7869.12	FRP3070	07.8301.33	FCP777	07.9312.46	FCP1664	4038	FCP726
07.8300.00	FCP905	07.8301.34	FCP789	07.9312.47	FCP1664	4044	FCP905
07.8300.01	FCP776	07.8301.35	FCP845	07.9551.13	FRP3098	4049	FCP1308
07.8300.02	FCP775	07.8301.36	FCP859	07.A010.10	FRP3113	4056	FCP3
07.8300.04	FCP1094	07.8301.37	FCP876	07.A262.20	FRP3103	4059	FCP1333
07.8300.07	FCP691	07.8301.38	FCP881	07.B314.30	FCP1281	4060	FCP116
07.8300.09	FCP725	07.8301.39	FCP925	07.B314.58	FRP3099	4060	FCP1562
07.8300.10	FCP779	07.8301.41	FCP1049	07.B314.59 (Th 16.8)	FRP3098	4061	FCP1298
07.8300.11	FCP856	07.8301.42	FCP1050	7767.XX.17	FRP216	4061	FCP1561
07.8300.12	FCP867	07.8301.43	FCP1052	P23133	FCP4308	4062	FCP72
07.8300.14	FCP590	07.8301.44	FCP1101	P83 024	FCP1021	4066	FCP1334
07.8300.15	FCP986	07.8301.45	FCP1056	P83 048	FCP1456	4069	FCP1372
07.8300.17	FCP748	07.8301.46	FCP1063	P83 049	FCP1457	4077	FCP777
07.8300.18	FCP761	07.8301.48	FCP1068	P83 066	FCP1698	4083	FCP598
07.8300.20	FCP1430	07.8301.49	FCP392	P85124	FCP4697	4085	FCP167
07.8300.23	FCP748	07.8301.50	FCP779	XA4.17.M4	FRP3109	4088	FCP1094
07.8300.24	FCP1213	07.8301.51	FCP1081	XA5.71.M2	FRP3099	4102	FCP761
07.8300.25	FCP1224	07.8301.52	FCP1082	XA7.G0.11	FCP4168	4104	FCP1300
07.8300.26	FCP1430	07.8301.53	FCP1093	XA7.G0.12	FCP4168	4106	FCP1012
07.8300.27	FCP904	07.8301.54	FCP1101			4107	FCP1011
07.8300.33	FCP1436	07.8301.55	FCP1113	CL BRAKES	Ferodo	4114	FCP9
07.8300.36	FCP1437	07.8301.56	FCP1133	4000	FCP845	4126	FRP3096
07.8300.38	FCP590	07.8301.57	FCP1134	4001	FCP560	5000W38T10	FCP342
07.8300.40	FCP590	07.8301.59	FCP1160	4002	FCP451	5001W43T14	FCP825
07.8300.42	FCP1327	07.8301.60	FCP1162	4003	FCP11	5002W43T14	FCP809
07.8301.00	FCP1063	07.8301.61	FCP1281	4004	FCP2	5002W48T14	FCP810
07.8301.02	FCP173	07.8301.62	FCP1288	4005	FCP881	5005W50TX	FRP1077
07.8301.03	FCP206	07.8301.63	FCP775	4005	FCP891	5008W52T18	FCP1281
07.8301.04	FCP276	07.8301.64	FCP1293	4007	FCP393		
						EBC	Ferodo
						DP108	FCP9

BRAKE PADS X-REF

COMPETITORS TO FERODO

EBC	Ferodo	FMSI	Ferodo	FMSI	Ferodo	FMSI	Ferodo
DP114	FCP809	D1204	FCP4080	D378	FCP173	D647	FCP986
DP1958	FCP1441	D125	FCP351	D382	FCP408	D648	FCP766
DP2035	FRP5002	D127	FCP93	D394	FCP779	D653	FCP1430
DP21588	FCP1808	D1308	FCP1747	D395	FCP256	D681	FCP997
DP21758	FCP4187	D1309	FCP1806	D396	FCP578	D682	FCP1001
DP21789	FCP4080	D1346	FCP4172	D396	FCP850	D683	FCP1483
DP21882	FCP4671	D1347	FCP4173	D403	FCP584	D684	FCP775
DP21995-DP31995	FCP4218	D135	FCP817	D409	FCP748	D687	FCP590
DP2291	FCP167	D1368	FCP4168	D412	FCP1224	D692	FCP850
DP2325	FCP173	D1371	FCP4218	D423	FCP415	D692	FCP1301
DP4039R	FRP3148	D1372	FCP4217	D427	FCP586	D695	FCP867
DP4057	FRP3108	D1382	FRP3106	D430	FCP691	D696	FCP774
DP41657	FCP1698	D1395	FCP5030	D439	FCP1133	D700	FCP600
DP4413R	FRP3078	D1405	FRP3133	D447	FCP560	D707	FCP1437
DP4993	FCP1457	D1454	FCP4426	D449	FCP600	D721	FCP1327
DP5039NDX	FRP3148	D147	FCP370	D453	FCP881	D723	FCP765
DP617	FCP408	D154	FRP3058	D454	FCP546	D725	FCP779
DP680	FCP541	D1576	FCP4671	D460	FCP986	D737	FCP1307
DP753	FCP399	D1609	FCP4611	D461	FCP1372	D738	FCP1308
DP9039	FRP3148	D163	FCP399	D462	FCP600	D740	FCP1050
DPX2002	FCP4426	D1656	FCP4663	D464	FCP638	D763	FCP850
		D174	FCP116	D465	FCP761	D764	FCP761
		D202	FRP3058	D470	FCP789	D768	FCP1094
ENDLESS	Ferodo	D227	FCP774	D471	FCP790	D770	FCP1333
EP472	FCP4187	D227	FCP775	D473	FCP487	D776	FRP3051
RCP100	FRP3083	D228	FCP596	D485	FCP600	D781	FCP1300
		D242	FCP308	D491	FCP878	D794	FCP1382
FMSI	Ferodo	D253	FCP256	D493	FCP1133	D810	FCP1281
D004	FCP9	D272	FCP638	D503	FCP905	D815	FCP1430
D005	FCP825	D278	FCP1133	D51	FCP810	D816	FCP1318
D009	FCP815	D279	FCP296	D516	FCP558	D817	FCP1528
D0109	FCP448	D280	FCP392	D525	FCP653	D819	FCP1068
D027	FCP823	D283	FCP372	D526	FCP1430	D837	FCP1093
D031	FCP2	D287	FCP11	D530	FCP765	D840	FCP1323
D044	FCP809	D290	FCP775	D54	FCP29	D847	FCP1661
D045	FCP11	D292	FCP845	D547	FCP856	D851	FCP541
D052	FRP3057	D298	FCP276	D548	FCP857	D886	FCP1319
D058	FCP2	D30	FCP3	D555	FCP590	D888	FCP1690
D064	FCP342	D306	FCP541	D558	FCP725	D905	FCP1693
D081	FCP832	D307	FCP385	D562	FCP867	D918	FCP1628
D096	FCP105	D313	FRP3057	D563	FCP948	D919	FCP1672
D1001	FCP1334	D319	FCP487	D568	FCP777	D929	FCP1639
D1001	FRP3067	D323	FCP638	D568	FCP904	D939	FCP1499
D1016	FCP1334	D330	FCP167	D569	FCP392	D940	FCP1676
D1018	FCP1655	D331	FCP483	D590	FCP565	D946	FCP1073
D1050	FCP1334	D340	FCP541	D592	FCP721	D960	FCP1561
D1053	FCP721	D340	FCP726	D594	FCP891	D961	FCP1562
D1078	FCP1984	D341	FCP748	D606	FCP1457	D968	FCP1281
D1081	FRP3129	D345	FCP451	D608	FCP451	D969	FCP1786
D1082	FRP3130	D350	FCP206	D609	FCP560	D97	FCP72
D109	FCP116	D350	FCP1081	D617	FCP1436	D970	FCP1568
D1107	FCP1641	D356	FCP308	D618	FCP1285	D976	FCP1698
D1108	FCP1636	D369	FCP1213	D621	FCP776	D978	FCP1308
D1114	FCP1947	D371	FCP393	D635	FCP1011	D990	FCP1392
D1116	FRP3100	D372	FCP560	D636	FCP1012	D991	FRP3075
D1124	FCP4187	D373	FCP598	D639	FCP1298		
D1170	FCP1808						
						HAWK	Ferodo
						HB103 0,59	FRP3057

BRAKE PADS X-REF

COMPETITORS TO FERODO

HAWK	Ferodo
HB105 0,62	FRP1077
HB108	FCP825
HB109 0,71	FRP3003
HB111 0,61	FCP1224
HB113 0,59	FCP598
HB118 0,56	FCP809
HB119 0,594	FRP3058
HB135 0,77	FCP779
HB136 0,69	FCP725
HB137 0,69	FCP256
HB141 0,65	FCP560
HB143 0,68	FCP905
HB144 0,719	FCP904
HB149 0,505	FCP1011
HB155 0,58	FCP483
HB158 0,515	FCP372
HB159 0,492	FCP1012
HB170 0,65	FCP451
HB171 0,59	FCP11
HB172 0,595	FCP2
HB178 0,564	FCP986
HB179 0,63	FCP1372
HB180 0,56	FCP1562
HB180 0,64	FCP116
HB180 0,64	FCP448
HB181 0,66	FCP1298
HB184 .650A	FCP891
HB189 0,55	FCP392
HB190 .600A	FCP774
HB190 .730A	FCP775
HB191 0,59	FCP308
HB193 0,61	FRP3028
HB193 0,67	FCP1281
HB194 0,57	FCP721
HB194 0,575	FCP721
HB194 0,665	FCP721
HB195 0,64	FCP1133
HB206 0,565	FCP399
HB214 0,618	FCP765
HB227 0,63	FCP578
HB227 0,63	FCP850
HB235 0,665	FCP600
HB242 0,661	FCP748
HB245 0,631	FCP1436
HB246 0,567	FCP487
HB261 0,665	FCP600
HB262 0,54	FCP638
HB268 0,665	FCP691
HB269 .763A	FCP590
HB271 0,635	FCP541
HB271 0,635	FCP596
HB275 0,62	FCP761
HB278 0,583	FCP878
HB289 0,61	FCP1307
HB290 0,583	FCP1308
HB291 0,642	FRP3051

HAWK	Ferodo
HB310 0,689	FCP867
HB320 0,669	FCP1437
HB325 0,72	FCP856
HB328 0,685	FCP1528
HB332 0,654	FCP1213
HB346 0,713	FCP1318
HB352 0,665	FCP1327
HB354 .756A	FCP1323
HB362 0,642	FCP857
HB364 0,642	FCP541
HB365 0,728	FCP1094
HB367 0,585	FCP790
HB370 0,559	FCP1693
HB387 0,547	FCP1690
HB388 0,756	FCP1068
HB395 0,58	FCP105
HB399 0,63	FCP296
HB408 0,665	FCP789
HB412 0,665	FCP1430
HB420 0,748	FCP766
HB430 0,547	FCP1319
HB432 0,661	FCP1639
HB434 0,543	FCP1333
HB444 0,685	FCP1499
HB445 0,61	FCP1676
HB448 0,61	FCP1786
HB449 0,679	FCP1568
HB453 0,585	FCP1334
HB453 0,585	FRP3067
HB464 0,764	FCP1073
HB483 0,635	FRP3075
HB484 0,670	FRP3129
HB485 0,656	FRP3130
HB491 0,693	FCP1382
HB492 0,732	FCP1285
HB493 0,65	FCP1392
HB495 0,756	FCP1050
HB497 0,776	FCP997
HB500 0,645	FCP1093
HB518 0,642	FCP1483
HB533	FCP1984
HB542x.600	FRP3148
HB543 0,76	FCP1641
HB544 0,628	FCP1636
HB545 0,564	FCP1561
HB546 0,654	FCP1300
HB557	FCP1947
HB560	FCP4080
HB570 .677	FCP1747
HB574 .666	FCP1806
HB601 .626	FCP4172
HB602 .545	FCP4173
HB603x.616	FCP4218
HB604x.598	FCP4217
HB609 0,572	FCP1664
HB624x.642	FCP1808

HAWK	Ferodo
HB631	FCP5030
HB649	FRP3133
HB668	FCP4426
HB671	FCP4187
LUCAS/TRW	Ferodo
GDB1905	FCP4308
GDB3484	FCP4354
MINTEX	Ferodo
CVP020	FCP419
CVP020K	FCP419
CVP043	FCP817
MDB1002	FCP2
MDB1003	FCP11
MDB1008	FCP22
MDB1012	FCP3
MDB1013	FCP29
MDB1065	FCP725
MDB1068	FCP2
MDB1072	FCP93
MDB1074	FCP96
MDB1081	FCP105
MDB1088	FCP360
MDB1099	FCP116
MDB1107	FCP39
MDB1141	FCP173
MDB1155	FCP253
MDB1165	FCP461
MDB1175	FCP206
MDB1190	FCP775
MDB1191	FCP596
MDB1218	FCP351
MDB1230	FCP256
MDB1239	FCP296
MDB1240	FCP370
MDB1251	FCP308
MDB1253	FCP774
MDB1257	FCP370
MDB1258	FCP360
MDB1266	FCP392
MDB1267	FCP419
MDB1273	FCP385
MDB1286	FCP408
MDB1290	FCP276
MDB1291	FCP393
MDB1295	FCP484
MDB1309	FCP409
MDB1309	FCP1113
MDB1312	FCP415
MDB1316	FCP406
MDB1323	FCP399
MDB1327	FCP434
MDB1339	FCP558
MDB1348	FCP487
MDB1351	FCP483

MINTEX	Ferodo
MDB1353	FCP527
MDB1357	FCP441
MDB1360	FCP472
MDB1361	FCP448
MDB1369	FCP578
MDB1371	FCP774
MDB1374	FCP598
MDB1377	FCP1491
MDB1382	FCP541
MDB1384	FCP524
MDB1385	FCP586
MDB1386	FCP584
MDB1391	FCP565
MDB1393	FCP779
MDB1400	FCP602
MDB1401	FCP660
MDB1403	FCP546
MDB1413	FCP653
MDB1416	FCP986
MDB1436	FCP385
MDB1437	FCP415
MDB1445	FCP878
MDB1451	FCP691
MDB1455	FCP11
MDB1456	FCP451
MDB1457	FCP560
MDB1473	FCP660
MDB1483	FCP535
MDB1488	FCP600
MDB1493	FCP617
MDB1496	FCP789
MDB1497	FCP790
MDB1499	FCP9
MDB1503	FCP646
MDB1511	FCP647
MDB1513	FCP519
MDB1518	FCP565
MDB1525	FCP598
MDB1531	FCP590
MDB1533	FCP761
MDB1538	FCP725
MDB1539	FCP765
MDB1543	FCP905
MDB1551	FCP856
MDB1552	FCP857
MDB1556	FCP732
MDB1564	FCP956
MDB1570	FCP774
MDB1571	FCP775
MDB1572	FCP850
MDB1583	FCP660
MDB1589	FCP748
MDB1606	FCP524
MDB1607	FCP170
MDB1610	FCP776
MDB1614	FCP1285

BRAKE PADS X-REF

COMPETITORS TO FERODO

MINTEX	Ferodo	MINTEX	Ferodo	MINTEX	Ferodo	MINTEX	Ferodo
MDB1615	FCP777	MDB1919	FCP1289	MDB2274	FCP1639	MDB2791	FCP1859
MDB1622	FCP766	MDB1921	FCP1437	MDB2281	FCP1540	MDB2816	FCP4080
MDB1623	FCP859	MDB1934	FCP1134	MDB2283 (Ex 2183)	FCP1399	MDB2828	FCP4217
MDB1628	FCP845	MDB1935	FCP483	MDB2291	FCP1528	MDB2833	FCP4064
MDB1633	FCP721	MDB1944	FCP1382	MDB2294	FCP1419	MDB2842	FRP3051
MDB1635	FCP904	MDB1950	FCP1334	MDB2309	FCP372	MDB2847	FCP1430
MDB1637	FCP685	MDB1956	FCP1160	MDB2314	FCP1394	MDB2868	FCP558
MDB1639	FCP408	MDB1958	FCP1318	MDB2341	FCP1561	MDB2875	FCP4426
MDB1658	FCP867	MDB1959	FCP1319	MDB2342	FCP1562	MDB2887	FCP1917
MDB1659	FCP613	MDB1962	FCP360	MDB2351	FCP600	MDB2929	FCP4050
MDB1662	FCP876	MDB1971	FCP904	MDB2352	FCP638	MDB2930	FCP1975
MDB1666	FCP925	MDB1972	FCP613	MDB2387	FCP1786	MDB2934	FCP4044
MDB1676	FCP881	MDB1984	FCP1285	MDB2417	FRP3051	MDB2937	FRP3143
MDB1686	FCP1011	MDB1999	FCP1333	MDB2418	FCP1628	MDB2952	FCP4045
MDB1688	FCP948	MDB2003	FCP1459	MDB2419	FCP1672	MDB2960	FCP4191
MDB1693	FCP1280	MDB2004	FCP1483	MDB2544	FCP1655	MDB2967	FCP1430
MDB1705	FCP1012	MDB2006	FCP1368	MDB2555	FCP558	MDB2972	FCP4316
MDB1723	FCP809	MDB2012	FCP1370	MDB2562	FCP1372	MDB2974	FCP4218
MDB1727	FCP1093	MDB2013	FCP1528	MDB2576	FCP1631	MDB2975	FCP4713
MDB1732	FCP1063	MDB2029	FCP1392	MDB2580	FCP1636	MDB3006	FCP4187
MDB1734	FCP1056	MDB2033	FCP1162	MDB2592	FRP3067	MDB3007	FCP1773
MDB1735	FCP1052	MDB2034	FCP1094	MDB2595	FCP1617	MDB3033	FRP3075
MDB1736	FCP1049	MDB2039	FRP3050	MDB2598	FCP1661	MDB3044	FCP4249
MDB1742	FCP995	MDB2042	FCP1324	MDB2601	FCP1664	MDB3050	FCP4173
MDB1745	FCP997	MDB2044	FCP1444	MDB2604	FCP1641	MDB3086	FCP1655
MDB1746	FCP1001	MDB2051	FCP1349	MDB2624	FCP1795	MDB3092	FCP4191
MDB1752	FCP1298	MDB2064	FCP1661	MDB2628	FCP1399	MDB3100	FCP4697
MDB1794	FCP1327	MDB2068	FCP1052	MDB2633	FCP1640	MDB3101	FCP4697
MDB1804	FCP1054	MDB2073	FCP1424	MDB2639	FCP1676	MDB3114	FCP4354
MDB1805	FCP1101	MDB2076	FCP1376	MDB2644	FCP1466	MDB3125	FCP1795
MDB1810	FCP767	MDB2110	FCP1081	MDB2677	FCP1765	MDB3131	FCP1806
MDB1811	FCP1094	MDB2130	FCP1294	MDB2681	FCP1806	MDB3150	FCP1931
MDB1812	FCP1112	MDB2131	FCP1378	MDB2682	FCP1747	MDB3168	FCP4430
MDB1813	FCP1068	MDB2132	FCP1134	MDB2683	FCP1807	MDB3173	FCP4425
MDB1817	FCP1073	MDB2162	FCP1499	MDB2684	FCP1751	MDB3193	FCP1466
MDB1826	FCP1323	MDB2191	FCP472	MDB2686	FCP1931	MDB3208	FCP4353
MDB1828	FCP1160	MDB2193	FCP767	MDB2692	FCP1773	MDB3233	FCP4353
MDB1859	FCP1334	MDB2206	FCP1160	MDB2694	FCP1629	MDB3243	FCP4955
MDB1860	FCP891	MDB2210	FCP1540	MDB2697	FCP1954	MDB3269	FCP4663
MDB1868	FCP1312	MDB2213	FCP1553	MDB2701	FCP1725	MDB3315	FCP4587
MDB1871	FCP1050	MDB2214	FCP1563	MDB2704	FCP1984	MDB3322	FCP4612
MDB1872	FCP1288	MDB2221	FCP1348	MDB2717	FCP1808	MDB3340	FCP4433
MDB1873	FCP1307	MDB2223	FCP1521	MDB2720	FCP1783	MDB3364	FCP4416
MDB1874	FCP1308	MDB2224	FCP1441	MDB2725	FCP1667	MGB521	FCP815
MDB1876	FCP1113	MDB2225	FCP1441	MDB2732	FCP1947	MGB522	FCP9
MDB1877	FCP721	MDB2231	FCP1717	MDB2743	FCP1790	MGB533	FCP809
MDB1883	FCP1081	MDB2238	FCP1469	MDB2749	FCP1706	MGB535	FCP810
MDB1884	FCP1082	MDB2239	FCP1466	MDB2750	FCP1625	MGB585	FCP817
MDB1888	FCP1301	MDB2240	FCP1467	MDB2751	FCP1626	MGB633	FCP167
MDB1891	FCP1560	MDB2241	FCP1468	MDB2758	FCP370	MLB10	FCP823
MDB1893	FCP1012	MDB2247	FCP1690	MDB2763	FCP1301	MLB19	FCP342
MDB1895	FCP767	MDB2254	FCP1543	MDB2765	FCP1672	MLB20	FCP825
MDB1901	FCP1300	MDB2256	FCP1491	MDB2770	FCP1862	MLB52	FCP832
MDB1907	FCP1295	MDB2257	FCP1573	MDB2779	FCP1858	MLB65	FCP840
MDB1908	FCP1293	MDB2261	FCP1693	MDB2789	FCP1631	MTX1594	FRP3057
MDB1910	FCP1501	MDB2262	FCP1520	MDB2790	FCP1805	MTX1595	FRP3058

BRAKE PADS X-REF

COMPETITORS TO FERODO

MINTEX	Ferodo	OE PORSCHE	Ferodo	PAGID	Ferodo	PAGID	Ferodo
MTX1890	FCP448	955.351.939.00 / .01 / .02	FCP1625	1295	FCP779	1977	FCP4697
MTX1976	FCP1281	97035194905	FCP4713	1349	FCP789	2016	FRP3040
		97035294902	FCP4713	1361	FRP216	2017	FRP3046
OE ALFA ROMEO	Ferodo	97035294904	FCP4713	1362	FCP342	2019	FRP3131
71770092	FCP4308	97035294905	FCP4713	1363	FCP825	2019	FRP3150
77365357	FCP4308	99135194902	FCP4955	1406	FCP986	20345	FRP3083
		99135294803	FCP4713	1408	FCP1348	20346	FRP3084
OE AUDI	Ferodo	99135294881	FCP4665	1427	FCP1298	20349	FRP3085
5Q0698451	FCP4434			1538	FRP3061	2053	FRP1064
8E0698451D	FCP1491	OE Renault	Ferodo	1544	FCP660	2105	FRP1059
8E0698451E	FCP1491	410605055R	FCP4249	1587	FCP1562	2126	FRP3018
8E0698451L	FCP541	440600364R	FCP1491	1591	FCP765	2127	FRP219
8J0698151A	FCP4223	440600678R	FCP541	1594USA	FRP3057	2130	FCP385
8J0698151F	FCP4223	440602070R	FCP1491	1595	FRP1077	2141	FRP1061
8K0698151 / B	FCP4044	440607960R	FCP1491	1595USA	FRP3058	2180	FCP725
8K0698151A	FCP4045	440608746R	FCP4249	1596	FCP748	2180	FCP1300
8K0698451	FCP4050	6025371650	FCP1491	1607	FRP302	2205	FRP3097
8K0698451A	FCP4050	7701206599	FCP1441	1609	FCP393	2275	FCP1068
8V0698151	FCP4433			1610	FCP558	2388	FCP1133
8V0698151B	FCP4433	Oe Suzuki	Ferodo	1616	FRP3140	2405	FRP3051
8V0698451	FCP4434	5581057K01	FRP3118	1616	FRP3140	2406	FCP1308
				1617	FRP3140	2407	FCP1307
OE BMW	Ferodo	OE VOLKSWAGEN	Ferodo	1617	FRP3140	2445	FCP1280
34 11 6 850 568	FCP4489	1K0698451J	FCP1491	1618	FRP3030	2474	FRP3050
34 216 784808	FCP4217	5Q0698451	FCP4434	1618	FRP3030	2487	FCP1334
34 216 791421	FCP4217	7L0698151 / B / D / H	FCP1625	1619	FRP3029	2488	FRP3031
34106799805	FCP4611	7L6698151 / C	FCP1625	1620	FCP876	2555	FRP501
34106860020	FCP4872	8J0698151F	FCP4223	1674	FRP1078	2557	FRP3037
34112284369	FCP4712	8P0698151	FCP4223	1675	FCP685	2558	FRP3055
34116786044	FCP4218	8V0698451	FCP4434	1678	FCP590	2559	FRP3055
34116850850	FCP4611	8X0698151	FCP1641	1682	FCP878	2581USA	FRP3148
34116857968	FCP4611			1682	FCP1560	2593	FCP1562
34116859066	FCP4611	P.MU	Ferodo	1702	FCP565	2623	FCP905
34116859282	FCP4611	F1103	FRP3148	1703	FCP360	2683	FCP856
34216855474	FCP4663			1705	FRP1079	2683	FCP997
		PAGID	Ferodo	1736	FCP4050	2685	FCP857
OE FORD	Ferodo	1141	FCP296	1743	FCP774	2685	FCP1483
1809458	FCP1931	1144	FCP256	1744	FCP775	2688	FRP3039
2003984	FCP4830	1158	FCP541	1748	FCP4044	2703	FRP3042
		1158	FCP1491	1749	FRP218	2707	FRP3075
OE LEXUS	Ferodo	1163	FCP408	1756	FRP3012	2723	FCP2
0446548150	FCP4354	1177	FCP586	1760	FCP546	2743	FRP3009
0446548160	FCP4354	1177	FCP586	1760	FCP4045	2830	FCP1001
0446548190	FCP4354	1190	FCP415	1796	FRP502	2845	FCP1626
		1192	FRP101	1798USA	FRP503	2931	FCP1664
OE MAZDA	Ferodo	1203	FCP451	1809USA	FRP506	2959	FCP1499
NAY03323ZA	FCP653	1204	FCP560	1813	FRP1060	3102	FCP809
		1218	FRP3059	1842	FCP891	3190	FCP810
OE MERCEDES	Ferodo	1265	FRP201	1852	FRP3000	3242	FCP596
0044207520	FCP4412	1267	FRP217	1896	FRP3024	3276	FCP845
0064203520	FCP4587	1269	FRP203	1897	FCP1283	4011	FCP392
0064206320	FCP4587	1270	FRP212	1903	FRP3054	4122	FCP3
1644201020	FCP4413	1283	FRP308	1904	FRP3003	4304	FCP2
1644202420	FCP4413	1285	FCP578	1904	FRP3144	4345	FRP3083
		1287	FCP1281	1908	FRP3042	4346	FRP3084
OE Mitsubishi	Ferodo	1288	FCP584	1976	FCP4697	4346	FRP3084
4605A492	FCP765						

BRAKE PADS X-REF

COMPETITORS TO FERODO

PAGID	Ferodo	PAGID	Ferodo	PAGID	Ferodo	PFC	Ferodo
4349	FRP3085	8081	FRP3106	T2444	FCP1641	0548	FCP1483
4501	FCP11	8081	FRP3133	T2454	FCP1636	0558	FCP725
4503	FCP11	8085	FCP4217	T5075	FCP1491	0558.XX	FCP725
4507	FCP116	8087	FRP3110	T5124	FCP1307	0562.XX	FCP867
4823	FCP206	8096	FCP4044	T5125	FCP1308	0590	FCP565
4905	FCP167	8101	FRP3128			0592.XX.15	FCP1348
4907	FCP4467	8113	FRP3130	PFC	Ferodo	0592.XX.17	FCP721
4909	FCP4713	8127	FCP1011	0031.XX	FCP2	0594.XX.18	FCP891
4917	FCP4064	8129	FCP1012	0044	FCP809	0617.XX	FCP1436
4922	FCP4955	8174	FCP1639	0045.XX	FCP11	0621	FCP776
4924	FCP4664	8175	FCP4187	0051	FCP810	0639	FCP1298
4925	FCP4665	8185	FCP1521	0052.XX	FRP3057	0639	FCP1561
4932	FCP4381	8188	FCP4806	0109	FCP1562	0648.XX	FCP766
4933	FCP4663	8201	FCP4425	0109-07-16-44	FRP3056	0682.XX	FCP997
4934	FCP4712	8203	FCP4711	0109.XX	FCP116	0707.XX	FCP1437
4936	FCP4316	8208	FRP3137	0154.XX	FRP3058	0731	FCP1553
4940	FCP1858	8212	FCP1399	0163.XX	FCP399	0732	FCP1563
8000	FRP3071	8214	FRP3115	0174.XX	FCP116	0738	FCP1307
8001	FCP1641	8222	FRP3039	0174.XX	FCP448	0738	FCP1308
8003	FRP3075	8235	FCP4664	0195	FCP170	0776	FRP3051
8004	FRP3096	8236	FRP3051	0242.XX	FCP308	0815.XX	FCP1430
8005	FRP3100	8240	FRP3094	0253.XX	FCP256	0816.XX	FCP1318
8006	FRP3095	8240front	FRP3094	0272	FCP484	0829	FCP1444
8008	FRP3143	8240rear	FRP3094	0278.XX	FCP1133	7683	FRP3025
8009	FRP3069	8245	FRP3014	0280.XX	FCP392	7700.XX.16	FRP1077
8010	FCP598	8250	FRP3015	0292	FCP845	7700.XX.18	FRP3007
8018	FRP3076	ERS496	FCP9	0340-07-15-44	FCP1491	7700.XX.20	FRP302
8021	FCP1672	ERS651	FCP1327	0345.XX	FCP451	7700.XX.25	FRP1078
8023	FCP1667	T1231	FRP3051	0350	FCP206	7702	FRP3059
8029	FCP1392	T1291	FRP3050	0356.XX	FCP308	7708	FRP1061
8030	FRP3087	T1350	FCP4223	0369.XX	FCP1213	7710	FRP101
8032	FRP5002	T1620	FCP4217	0373.XX	FCP598	7712	FRP3060
8033	FRP3088	T1635	FRP3051	0382	FCP408	7714	FRP217
8034	FRP3092	T1685	FCP1563	0394	FCP685	7718.XX.16	FRP3032
8035	FCP850	T1698	FCP1308	0394	FCP1773	7718.XX.18	FRP3070
8038	FRP3123	T1735	FCP4413	0394.XX	FCP779	7719	FCP342
8039	FCP1655	T1752	FRP3143	0395.XX	FCP256	7720	FCP825
8040	FRP202	T1753	FCP4805	0396	FCP1807	7735.XX.16	FRP1079
8041	FCP815	T1784	FCP4218	0396.XX	FCP578	7735.XX.20	FRP308
8042	FCP9	T1785	FCP4713	0396.XX	FCP850	7736	FRP3071
8043	FRP3141	T1799	FRP3051	0409.XX	FCP748	7740	FRP218
8046	FCP1636	T1830	FRP3067	0412	FCP1224	7742.XX.18	FRP3045
8049	FRP3103	T1857	FRP3075	0412.XX	FCP1224	7742.XX.20	FRP3004
8050	FRP3082	T1976	FCP4434	0447	FCP560	7742.XX.21	FRP3034
8051	FCP1808	T1997	FCP4354	0460	FCP986	7742.XX.22	FRP1059
8053	FCP4191	T2011	FCP4308	0460.XX	FCP986	7743.XX.17	FRP3023
8060	FRP3102	T2056	FCP4064	0461	FCP1372	7743.XX.20	FRP3022
8061	FRP3099	T2102	FCP4806	0461.XX	FCP1372	7743.XX.21	FRP3033
8062	FRP3098	T2150	FCP4955	0463	FCP483	7745	FRP219
8064	FCP1629	T2151	FCP4587	0465.XX	FCP761	7746	FRP3074
8067	FCP461	T2214	FCP4587	0473.XX	FCP487	7748.XX.18	FRP1058
8068	FCP840	T2239	FCP4433	0491	FCP878	7748.XX.20	FRP1064
8074	FCP4805	T2309	FCP4713	0503.XX	FCP905	7750.XX.20	FRP3074
8076	FCP4972	T2419	FCP4806	0526.XX	FCP1430	7751	FRP501
8077	FCP1894	T2423	FCP4663	0530.XX	FCP765	7752	FRP502
8078	FRP3117	T2440	FCP4611	0537	FCP956	7754	FRP504

BRAKE PADS X-REF

COMPETITORS TO FERODO

PFC	Ferodo	WVA	Ferodo	WVA	Ferodo	WVA	Ferodo
7755	FRP3009	20027 16,00	FCP9	21079 13,75	FCP408	21636 18,00	FCP1052
7756	FRP3012	20034	FCP2	21088 17,00	FCP399	21651 18,50	FCP905
7757	FRP506	20037 15,00	FCP823	21098 16,00	FCP441	21664 19,00	FCP1049
7760	FCP685	20046 15,30	FCP1459	21100 17,00	FCP524	21670 19,50	FCP1050
7765	FCP840	20053 10,00	FCP342	21103 14,50	FCP409	21674 18,00	FCP1063
7767	FRP212	20054 14,50	FCP825	21121 13,80	FCP484	21677 19,50	FCP1073
7767.XX.20	FRP212	20073 17,50	FCP29	21140 15,70	FCP586	21694 16,50	FCP776
7768.XX.16	FRP3018	20088 14,40	FCP809	21144 16,50	FCP596	21697 15,80	FCP777
7768.XX.20	FRP3073	20089 14,40	FCP810	21153 17,50	FCP646	21703 14,80	FCP790
7770.XX.17	FRP3087	20128 14,70	FCP39	21165 16,50	FCP546	21719 14,50	FCP956
7770.XX.20	FRP3024	20140 14,00	FCP72	21170 17,30	FCP527	21829 19,50	FCP1068
7770.XX.26	FRP3029	20166 16,00	FCP96	21171 19,00	FCP617	21866 15,30	FCP1288
7770.XX.26	FRP3030	20168 16,20	FCP774	21173 17,00	FCP660	21866 17,30	FCP1101
7772.XX.18	FRP3088	20168 19,60	FCP775	21179 16,80	FCP535	21866 19,70	FCP1054
7773.XX.30	FRP3040	20180 16,80	FCP850	21190 17,50	FCP584	21920 15,60	FCP1093
7775.XX.28	FRP3053	20228 15,20	FCP105	21193 18,00	FCP519	21925 17,80	FCP1300
7778.XX.25	FRP3039	20323 16,50	FCP116	21201-21190 17,50	FCP584	21927 17,00	FCP1056
7778.XX.28	FRP3037	20323 16,50	FCP448	21271 17,00	FCP647	21931 17,00	FCP1160
7778.XX.30	FRP3055	20328 12,90	FCP372	21273 19,50	FCP1285	21934 17,30	FCP1301
7780.XX.16	FRP3028	20380 15,50	FCP817	21277 15,00	FCP487	21937 16,20	FCP1307
7780.XX.18	FCP1281	20410 12,90	FCP1560	21282 17,20	FCP1483	21938 20,40	FCP1323
7781	FCP1334	20410 14,80	FCP878	21282 17,30	FCP857	21945 16,00	FCP1312
7781	FRP3067	20476 15,00	FCP170	21284 19,30	FCP856	21945 19,90	FCP1289
7790.XX.17	FRP3077	20491 15,20	FCP167	21292 17,30	FCP725	21947	FCP1021
7790.XX.18	FRP3003	20547 16,80	FCP732	21294 15,00	FCP602	21972 15,20	FCP1308
7790.XX.25	FRP3014	20561 15,00	FCP461	21307 14,50	FCP986	21974 19,40	FCP1094
7790.XX.25	FRP3061	20577 15,00	FCP832	21312 12,80	FCP472	21998 15,60	FCP1162
7790.XX.28	FRP3015	20629 20,00	FCP256	21322 15,00	FCP598	22271	FCP4873
7793.XX.18	FRP3054	20634 15,00	FCP881	21363 15,70	FCP765	22344	FCP4872
7797.XX.29	FRP3031	20640-20753 18,60	FCP206	21381 15,00	FCP1348	22569-22570-22571	FCP4830
7802.XX.18	FRP3045	20641 15,00	FCP93	21381 16,80	FCP721	23052 16,20	FCP1294
7802.XX.20	FRP3004	20675 17,00	FCP296	21388 18,50	FCP406	23057 20,00	FCP1295
7802.XX.22	FRP1059	20676 19,50 - 21624&21625 19,50	FCP590	21395 18,00	FCP766	23063 18,40	FCP1293
7804.XX.15	FRP3020	20676 20,10	FCP1717	21402 17,50	FCP891	23073 18,80	FCP1382
7804.XX.18	FRP3086	20754 15,00	FCP840	21430 17,30	FCP876	23092 15,00	FRP3067
7818.XX.17	FRP3050	20775 18,20	FCP351	21436 17,00	FCP925	23092 16,00	FCP1334
7819	FRP3075	20833 17,00	FCP370	21437 17,00	FCP925	23101 18,00	FCP1082
7871-07-16-44	FCP1667	20841 12,00	FCP360	21446 17,80	FCP748	23103-23104 18,00	FCP1081
		20870 15,00	FCP308	21463 18,00	FCP845	23124 19,00	FCP1112
		20877 17,50	FCP451	21468 15,50	FRP3127	23139 17,00	FRP3050
TAROX	Ferodo	20878 14,80	FCP483	21482 16,70	FCP948	23140 19,30	FCP1134
SP0239	FRP3078	20887 15,30	FCP392	21484 20,00	FCP1001	23142 15,00	FCP1561
		20887 19,70	FCP419	21495 17,00	FCP789	23154 19,00	FCP1318
TRW	Ferodo	20889 17,30	FCP385	21497 18,50	FCP904	23177 14,30	FCP1113
GDB1809	FCP4223	20905 18,00	FCP393	21515 17,50	FCP613	23178 18,00	FCP1444
GDB1957	FCP4434	20907 18,00	FCP276	21526 17,00	FCP600	23202 18,50	FCP1394
		20923 17,50	FCP434	21552 14,00	FCP653	23225 17,00	FCP1424
Wilwood	Ferodo	20939 15,90	FCP173	21553 14,00	FCP638	23245	FCP1441
6812	FRP3104	20941 19,30	FCP415	21560 18,00	FCP685	23281 18,00	FCP1499
7420	FRP3097	20953 17,50	FCP560	21561 17,00	FCP691	23309 17,00	FCP1672
7812	FRP3149	20961 15,20	FCP541	21580 14,30	FCP1562	23312 20,30	FCP1628
7912	FRP3108	20961 16,00	FCP1491	21583 18,80	FCP767	23313 20,30 - 24255 20,30	FCP4191
		20968 20,30	FCP779	21589 15,00	FCP726	23326	FCP1655
WVA	Ferodo	20973 11,00	FCP558	21601 17,50	FCP867	23329	FRP3051
20007 15,30	FCP815	20995 17,30	FCP578	21606 16,20	FCP995	23332 18,00	FCP1370
20009 15,00	FCP3	21074 19,00	FCP565	21626 15,00	FCP859	23348 16,50	FCP1368
20011 15,00	FCP11						

BRAKE PADS X-REF

COMPETITORS TO FERODO

WVA	Ferodo	WVA	Ferodo
23353 14,70	FCP1319	24180, 24181	FCP4413
23354 13,00	FCP1011	24194 15,3	FCP1553
23387 12,50	FCP1012	24197	FCP1563
23402 20,10 - 23403 20,10	FCP1520	24205	FCP4412
23409 19,30	FCP1543	24222 17,90	FCP1984
23417 15,20	FCP1521	24271 14,60	FCP1947
23482 16,50	FCP1540	24283	FCP4426
23497 15,40	FCP1501	24289 17,10 - 24290 17,10	FCP1975
23510 16,50	FCP1392	24298	FCP1894
23513 16,80	FCP1437	24315 17,10	FCP4217
23517 16,60	FCP1349	24316 17,00	FCP4218
23524	FCP1456	24339 19,90	FCP1805
23526 17,40	FCP1528	24349 17,20	FCP1858
23539	FCP1457	24408 19,40	FCP4044
23550 17,00	FCP1808	24409 19,40	FCP4044
23552 17,80	FCP1376	24455 16,90	FRP3133
23558 17,80	FCP1327	24513	FRP3129
23566 17,20	FCP1436	24552 16,10	FCP4064
23572 14,40	FCP1333	24554, 25691	FCP4713
23581 18,70	FCP1419	24606 17,50	FCP4050
23587 20,30	FCP1641	24659	FCP4379
23597 16,80	FCP1378	24680	FCP4327
23601 16,70	FCP1324	24703	FCP4381
23623 17,20	FCP1806	24705 20,00	FCP4045
23692	FCP1625	24706 20,00	FCP4045
23693 16,20	FCP1626	24707 20,00	FCP4045
23694	FCP1308	24709 18,00 - 24710 18,00	FCP4249
23705 17,10 - 24288 17,70&17,90	FCP1466	24738 19,8	FCP4425
23708 18,40	FCP1467	24743 19,40	FCP4044
23711 18,40	FCP1468	24764 17,00	FCP1667
23714 15,80	FCP1469	24847	FCP4468
23716 16,40	FCP1676	24851 15,60	FRP3135
23745 - 23271 17,70	FCP1661	24854 16,70	FCP4187
23760 17,50	FCP1795	24912-24913	FCP4489
23764 17,00	FCP1664	24920 15,60	FCP4172
23766 17,50	FCP1573	24956 15,50	FCP1786
23794 19,80	FCP1773	24974 16,70 - 20345 16,90	FRP3083
23801	FCP4223	24979	FCP4404
23832 20,40	FCP1640	25003	FCP4955
23855 16,00	FRP3120	25007	FCP4064
23871 14,00	FCP1693	25008 - 25010	FCP4697
23912 18,50 - 23801 18,50	FCP1706	25008, 25010	FCP4434
23912 20,20 - 23801 20,2	FCP1629	25028 18,30	FCP4611
23912 20,20 - 23801 20,2	FCP1765	25029 17,80	FCP4663
23914 16,90	FCP1636	25031	FCP4262
23915 17,60 - 23916 17,60	FCP1747	25086 20,20 or 25683-25684 20,30	FCP4433
23926 17,00	FCP1807	25134 16,70	FCP4612
23935 17,60	FCP1751	25156, 25157	FCP4308
23954 19,00 (Ex 23599)	FCP1399	25199	FCP4394
23959 17,40	FCP1790	25216, 25215	FCP4587
23973 16,80	FCP1617	25219	FCP4806
23984 17,90	FCP4080	25258	FCP4430
24024	FCP1698	25594 15,9	FRP3115
24086 15,50	FCP1862	25737 17,40 - 25736 17,40	FCP4416
24137 16,30	FCP1931		
24142 20,60 - 24141 19,10	FCP1631		

BRAKE LATER



FERODO Racing brake pads give you race winning bite, deceleration and control all the way to the Apex.

FERODO[®]
RACING

WWW.FERODORACING.COM

The Ferodo brand is a registered trademark of **FEDERAL-MOGUL MOTORPARTS**

FERODO®

RACING



FEDERAL-MOGUL ITALY Srl
Racing & Motorcycle Division

Corso Inghilterra, 2
12084 Mondovì (CN) - Italy
Tel. +39 0174 560511
Fax +39 0174 552248

www.ferodoracing.com



FEDERAL-MOGUL
MOTORPARTS

ECAT



CATFE701